

USER'S MANUAL

IPC950

Industrial Computers

User's Manual



www.axiomtek.com

Disclaimers

This manual has been carefully checked and believed to contain accurate information. Axiomtek Co., Ltd. assumes no responsibility for any infringements of patents or any third party's rights, and any liability arising from such use.

Axiomtek does not warrant or assume any legal liability or responsibility for the accuracy, completeness or usefulness of any information in this document. Axiomtek does not make any commitment to update the information in this manual.

Axiomtek reserves the right to change or revise this document and/or product at any time without notice.

No part of this document may be reproduced, stored in a retrieval system, or transmitted, in any form or by any means, electronic, mechanical, photocopying, recording, or otherwise, without the prior written permission of Axiomtek Co., Ltd.

©Copyright 2022 Axiomtek Co., Ltd.

All Rights Reserved

November 2022, Version A3

Printed in Taiwan

Safety Precautions

Before getting started, please read the following important safety precautions.

1. The IPC950 does not come equipped with an operating system. An operating system must be loaded first before installing any software into the computer.
2. Be sure to ground yourself to prevent static charge when installing the internal components. Use a grounding wrist strap and place all electronic components in any static-shielded devices. Most electronic components are sensitive to static electrical charge.
3. Disconnect the power cord from the IPC950 before making any installation. Be sure both the system and the external devices are turned OFF. Sudden surge of power could ruin sensitive components. Make sure the IPC950 is properly grounded.
4. Make sure the voltage of the power source is correct before connecting the equipment to the power outlet.
5. Turn OFF the system power before cleaning. Clean the system using a cloth only. Do not spray any liquid cleaner directly onto the screen.
6. Do not leave this equipment in an uncontrolled environment where the storage temperature is below -20°C or above 80°C . It may damage the equipment.
7. Do not open the system's back cover. If opening the cover for maintenance is a must, only a trained technician is allowed to do so. Integrated circuits on computer boards are sensitive to static electricity. To avoid damaging chips from electrostatic discharge, observe the following precautions:
 - Before handling a board or integrated circuit, touch an unpainted portion of the system unit chassis for a few seconds. This will help to discharge any static electricity on your body.
 - When handling boards and components, wear a grounding wrist strap, available from most electronic component stores.

Classification

1. Degree of protection against electric shock: not classified
2. Degree of protection against the ingress of water: none
3. Equipment not suitable for use in the presence of a flammable anesthetic mixture with air or with oxygen or nitrous oxide.
4. Mode of operation: Continuous
5. Type of protection against electric shock: Class I equipment

General Cleaning Tips

You may need the following precautions before you begin to clean the computer. When you clean any single part or component for the computer, please read and understand the details below fully.

When you need to clean the device, please rub it with a piece of dry cloth.

1. Be cautious of the tiny removable components when you use a vacuum cleaner to absorb the dirt on the floor.
2. Turn the system off before you start to clean up the component or computer.
3. Never drop the components inside the computer or get circuit board damp or wet.
4. Be cautious of all kinds of cleaning solvents or chemicals when you use them for the sake of cleaning. Some individuals may be allergic to the ingredients.
5. Try not to put any food, drink or cigarette around the computer.

Cleaning Tools:

Although many companies have created products to help improve the process of cleaning your computer and peripherals, users can also use household items to clean their computers and peripherals. Below is a listing of items you may need or want to use while cleaning your computer or computer peripherals.

Keep in mind that some components in your computer may require designated products for cleaning. If this is the case it will be mentioned in the cleaning instructions.

- **Cloth:** A piece of cloth is the best tool to use when rubbing up a component. Although paper towels or tissues can be used on most hardware as well, we still recommend rubbing it with a piece of cloth.
- **Water or rubbing alcohol:** You may moisten a piece of cloth a bit with some water or rubbing alcohol and rub it on the computer. Unknown solvents may be harmful to the plastics parts.
- **Vacuum cleaner:** Vacuuming the dust, dirt, hair, cigarette particles, and other particles out of a computer can be one of the best methods of cleaning a computer. Over time these items can restrict the airflow in a computer and cause circuitry to corrode.
- **Cotton swabs:** Cotton swabs moistened with rubbing alcohol or water are excellent tools for wiping hard to reach areas in your keyboard, mouse, and other locations.
- **Foam swabs:** Whenever possible it is better to use lint free swabs such as foam swabs.



Note: *Shut down the system before you start to clean any single components.*



Note: *Please check the temperature of the system surface before maintenance.*

Please follow the steps below:

1. Close all application programs;
2. Close operating software;
3. Turn off power switch;
4. Remove all devices;
5. Pull out the power cable.

Scrap Computer Recycling

Please inform the nearest Axiomtek distributor as soon as possible for suitable solutions in case computers require maintenance or repair; or for recycling in case computers are out of order or are no longer in use.

Trademark Acknowledgments

Axiomtek is a trademark of Axiomtek Co., Ltd.

Intel® and Pentium® are registered trademarks of Intel Corporation.

Windows 10, Windows 10 IoT Enterprise, Windows 7, are trademarks of Microsoft Corporation.

Other brand names and trademarks are the properties and registered brands of their respective owners.

Table of Contents

Safety Precautions	iii
Classification.....	iv
General Cleaning Tips	iv
Scrap Computer Recycling.....	vi
SECTION 1 INTRODUCTION.....	9
1.1 General Description	9
1.2 System Specifications.....	10
1.2.1 Main CPU Board	10
1.2.2 System I/O	10
1.3 Dimensions	13
1.4 I/O Outlets	17
1.5 Packing List	18
1.6 System Block Diagram.....	18
1.7 Jumper Setting Summary	19
1.7.1 Restore BIOS Optimal Defaults (JP4)	19
1.8 Connectors	20
1.8.1 DC-in Phoenix Power Connector	21
1.8.2 DisplayPort Connector	21
1.8.3 Serial Port Connector	22
1.8.4 USB 3.2 Connector	22
1.8.5 Ethernet Connector (LAN1~LAN3)	23
1.8.6 Audio Connector	23
1.8.7 ATX Power On/OFF Button	23
1.8.8 Remote Power Switch Connector	24
1.8.9 AT/ATX Switch	24
1.8.10 Digital I/O Connector	24
1.8.11 Front Panel LED	25
1.8.12 SATA Connector	25
1.8.13 SATA Power Connector	25
1.8.14 SIM Card Slot.....	26
1.8.15 Full-Size PCI Express Mini Card Slot.....	26
1.8.16 USB 2.0 Connector (CN9).....	27
1.8.17 M.2 B+M KEY 2280 Connector (SCN1).....	27
1.8.18 M.2 E-KEY 2230 Connector.....	29
1.8.19 Flexible IO - COM I/O Card Connector (AX93511)	30
1.8.20 Flexible IO – Isolated COM & DIO I/O Card (AX93512)	31
1.8.21 Flexible IO – Isolated COM x4 I/O Card (AX93516)	33
1.8.22 Flexible IO- USB3.0x2 & COMx2(RS232/422/485) & LAN(AX93519).....	34
SECTION 2 HARDWARE INSTALLATION	37
2.1 Installing the Memory Module	37
2.2 Installing the Hard Disk Drive	38
2.3 Installing the NVMe SSD	39
2.4 Installing the M.2 Key E Module	40
2.5 Installing the Mini PCIe Module	42
2.6 Installing the Flexible I/O Module	43
2.7 Mounting	44

SECTION 3 AMI BIOS UTILITY	47
3.1 Starting	47
3.2 Navigation Keys	48
3.3 Main Menu	49
3.4 Advanced Menu	50
3.5 Chipset Menu	62
3.6 Security Menu	63
3.7 Boot Menu	65
3.8 Save & Exit Menu	66
APPENDIX A WATCHDOG TIMER	69
A.1 About Watchdog Timer.....	69
A.2 How to Use Watchdog Timer.....	69
APPENDIX B WAKE on LAN	71
How to Set up Wake on LAN.....	71

SECTION 1 INTRODUCTION



This chapter contains general information and detailed specifications of the IPC950. Section 1 includes the following sections:

- General Description
- System Specifications
- Dimensions
- I/O Outlets
- Jumper Settings
- Connectors
- Package List

1.1 General Description

The IPC950 is a fanless system that supports Intel® 11th generation Core™ i7-1185G7E, i5-1145G7E, i3-1115G4E & Celeron® 6305E processors. The IPC950 is also built with a rugged design that makes the system suitable for the most enduring operation.

The operating systems supported by the IPC950 include Windows® 11, Windows® 10, Ubuntu, and embedded OS.



Note: Please disable the Windows Update switch via following link to avoid driver issues causing from Windows Update.

1. Open the Group Policy Editor (gpedit.msc) and navigate to **Computer Configuration\Administrative Templates\Windows Components\Windows update\Do not include drivers with Windows Updates.**

2. **Enable** this policy, which tells Windows to not include drivers with Windows quality updates.

1.2 System Specifications

1.2.1 Main CPU Board

- **CPU**
 - Intel® Tiger Lake U processor (15W) - i7-1185G7E, i5-1145G7E, i3-1115G4E & Celeron® 6305E
- **BIOS**
 - AMI BIOS
- **System Memory**
 - Two DR4-3200 un-buffered SO-DIMM max. up to 64GB
- **System Certification**
 - CE/FCC
- **Features**
 - Compact front IO design
 - Supports an PCIe expansion slot
 - DC to DC power supply with 24VDC (uMin=19V/uMax=30V) support
 - Supports one 2.5G LAN with TSN
 - Supports TPM2.0
 - Supports iAMT
 - Supports DIN rail, book shelf and wall mount

1.2.2 System I/O

- **Standard I/O Interface -- Front**
 - One ATX power on/off switch
 - One ATX/AT mode switch
 - One 2-pin connector output for remote power on/off switch
 - DC to DC power supply, which supports 24VDC (uMin=19V/uMax=30V) with a phoenix power plug
 - Four USB 3.2 Gen.2 ports
 -  *Note: IPC950 supports an internal USB2.0 with 180D type A connector for the license key, up to 20mm)*
 - One HDD/SSD access LED
 - Flashes green to indicate storage activity
 - One CPU status LED
 - Flashes orange to warn abnormal CPU temperature
 - Solid red shows DTS temp over spec. (Requires removal of DC input power to reset / clear)

- One Power LED
 - Solid green indicates device is on
- One Programmable (GPIO) LED
 - GPIO Controllable Green LED (controllable custom status)
- Two LAN with Intel® PHY I211-AT LAN controller
- One LAN with Intel® PHY I225-LM LAN controller
- Extension system I/O module:
 - AX93511 4 x RS-232/422/485 module (default RS-232)
 - AX93512 2 x RS-232/422/485 w/ isolated 1.5KVDC protection and 8-in/8-out isolated 1.5KVDC DIO
 - AX93516 4 x RS232/422/485 w/ isolated 2KVDC module
 - AX93519 2 x RS232/422/485 + 10/100/1000 Mbps ethernet (i211AT) + 2 USB 2.0



Note: The RS-485 auto flow control only supports below formats to communicate data:

8 data bits + 1 stop bit

8 data bits + 1 parity bit + 1 stop bit

8 data bits + 1 parity bit + 2 stop bits

8 data bits + 2 stop bits

7 data bits + 1 parity bit (even or odd) + 2 stop bits

- Two DP++ 1.2 4K support resolution up to 4096*2160 @60Hz
- One Audio (Line-out)
- **Expansion Interface**
 - Mini Card slot w/ SIM slot

One on board full-size PCI Express Mini Card slot with PCIe & USB interface w/ SIM slot
 - M.2 Key E socket

One on board M.2 2230 E Key socket
 - PCIe x4 slot

One PCIe x4 slot for Axiomtek I/O card

 - AX92320 2/4-port GigE PoE LAN PCI Express Card

Power from PCIe Slot max. 20W PoE power output

Power from ATX connector max. 100W PoE power output
 - AX92321 4-port/8-port USB 3.0 PCI Express Card with 4 Independent Host Controllers
 - AX92322 2-port/4-port GbE LAN PCI Express Card
 - AX92351 32-CH isolated digital I/O with digital filter



Note: The maximum power rating for expansion slots at 50 °C cannot exceed the following value:

The maximum loading of +3.3V+5V+12V<125W



Note: 12V maximum loading is 10A(100W)



Note: The system power rating may thus be changed based on differing combinations of attached devices.

- Drive Capacity
 - One 2.5" HDD driver bay (SSD/HDD 7 or 9.5 mm height)
 - One M.2 2280 Key B+M socket (SATA signal)
- Power Input
 - 24VDC (uMin=19V/uMax=30V) with phoenix power plug
 - Inrush current 20A or less



Note: Please maintain the system power input in 24VDC when plugging an add-on card.

- Operating Temperature
 - -10°C -50°C w/ W.T. HDD/SSD



Note: The performance of the system might be adversely affected when it is operating at a temperature above the system's limitation or with an unrecommended processor.



Note: If the operating temperature is above 35°C, it is recommended to use a wide temperature SSD on the device.

- Storage Temperature
 - -20°C ~ 80°C
- Humidity
 - 10% ~ 90% (non-condensing)

- Dimensions

- IPC950

- 69.5 mm (2.73") (W) x 225 mm (8.85") (H) x 230 mm (9") (D)

- IPC950 w/ 1 PCIe x4 expansion kit

- 108.5 mm (4.27") (W) x 225 mm (8.85") (H) x 230 mm (9") (D)



Note: All specifications and images are subject to change without notice.

1.3 Dimensions

The following diagrams show you the dimensions and outlines of the IPC950.

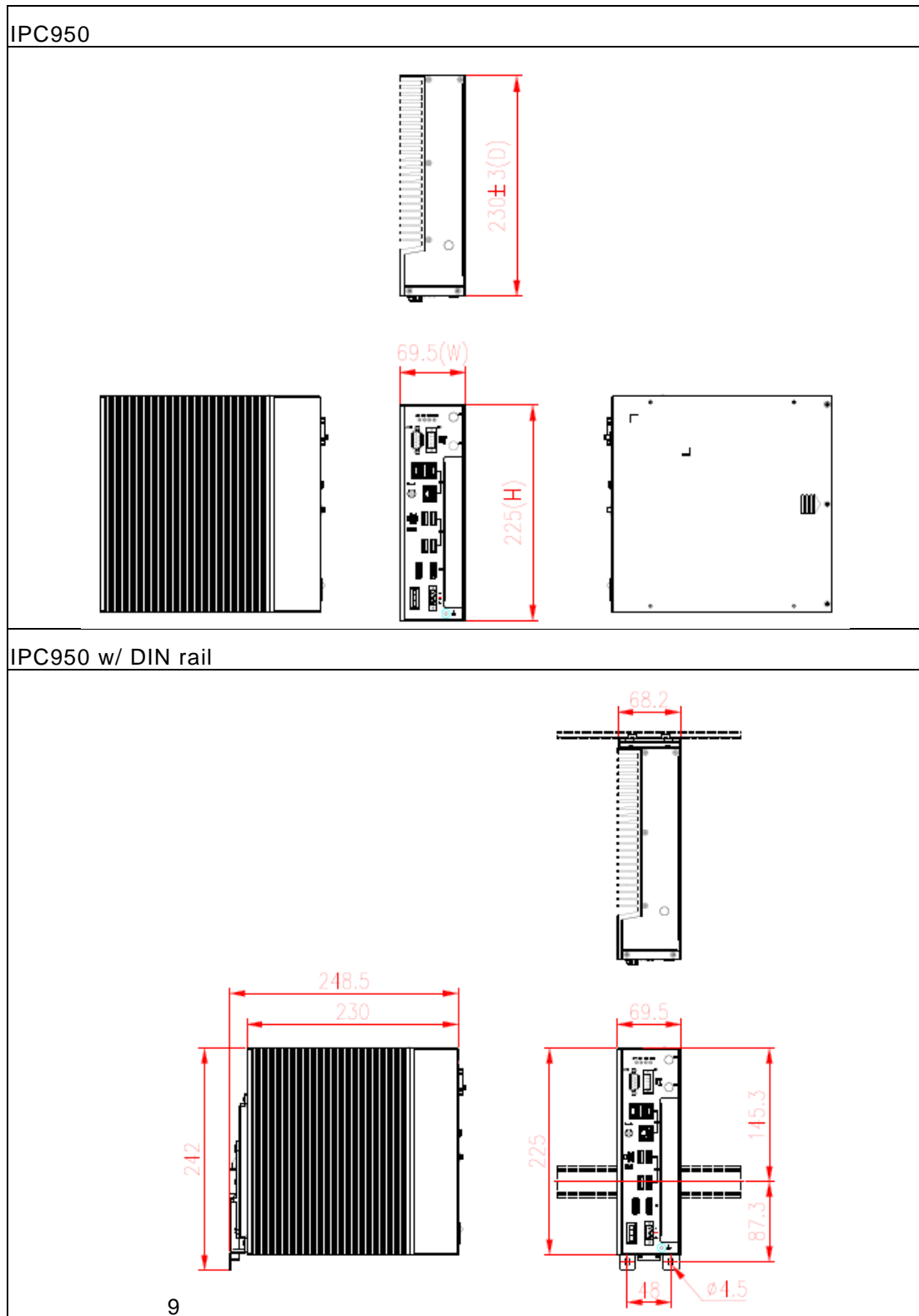

IPC950 w/ bookshelf

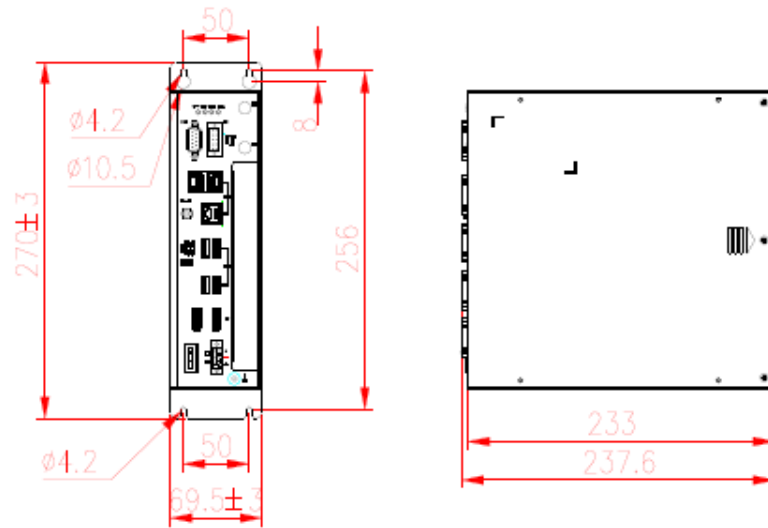

IPC950 w/ wall mount

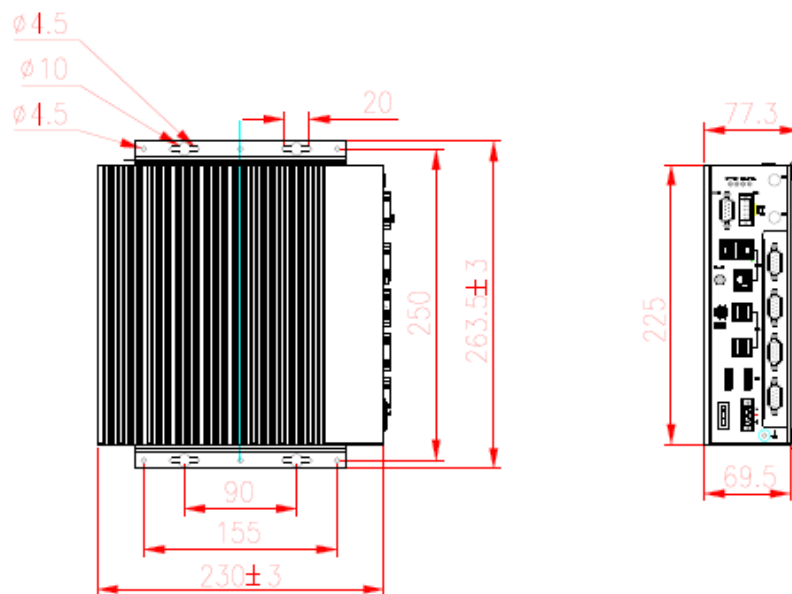

IPC950 w/ 1 PCIe x4 expansion kit

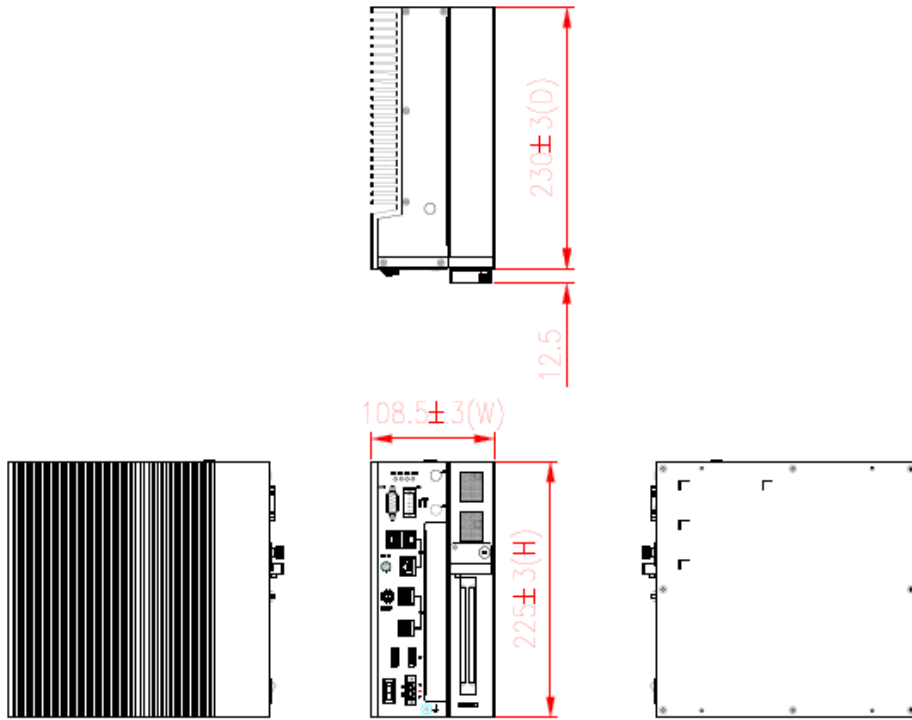

IPC950 w/ 1 PCIe x4 expansion kit and DIN rail

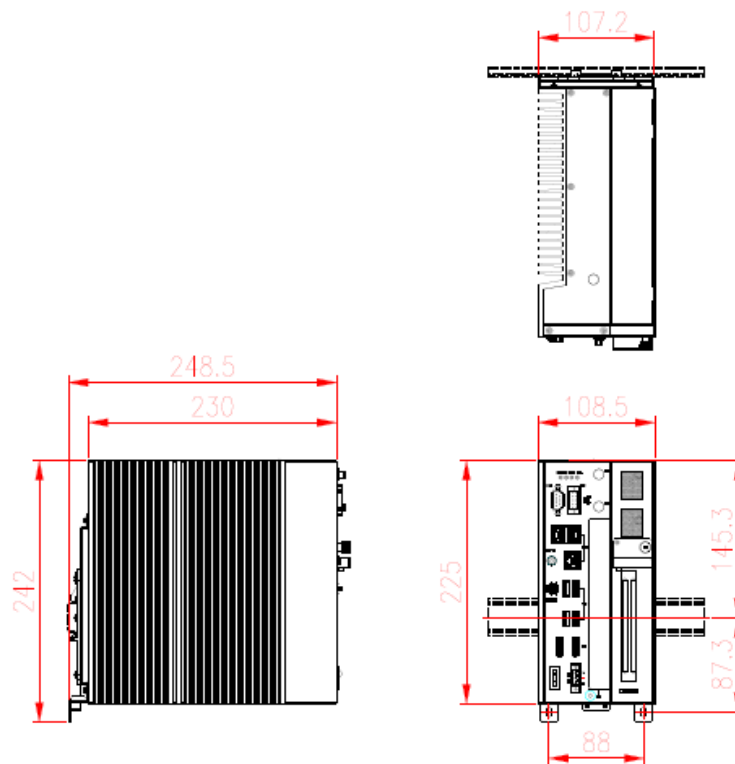

IPC950 w/ 1 PCIe x4 expansion kit and bookshelf

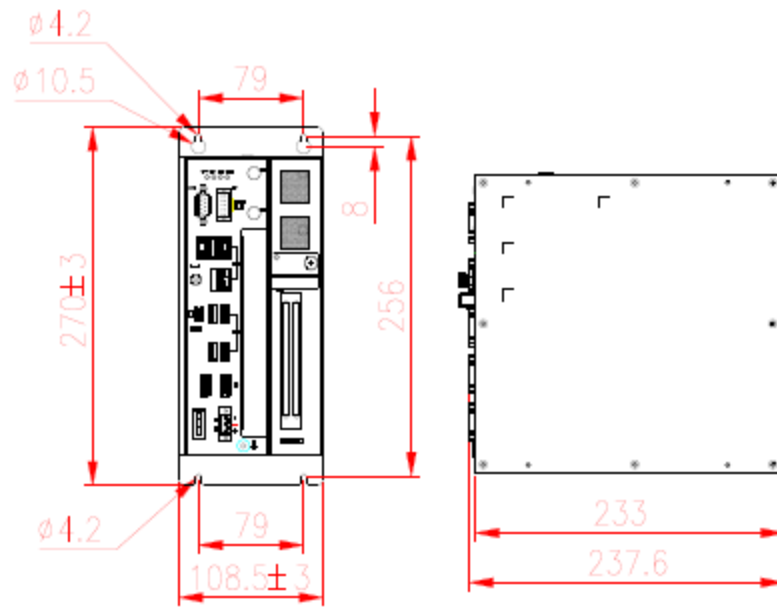

IPC950 w/ 1 PCIe x4 expansion kit and wall mount

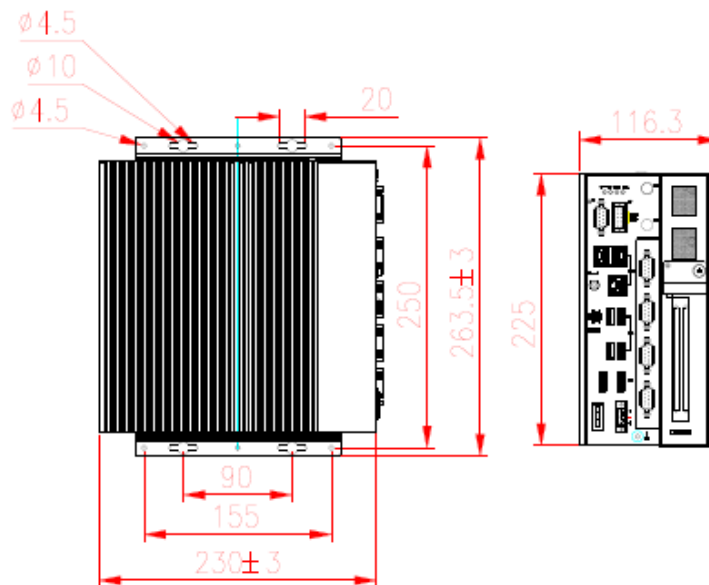

1.4 I/O Outlets

The following figures show the locations of the IPC950 series I/O outlets.

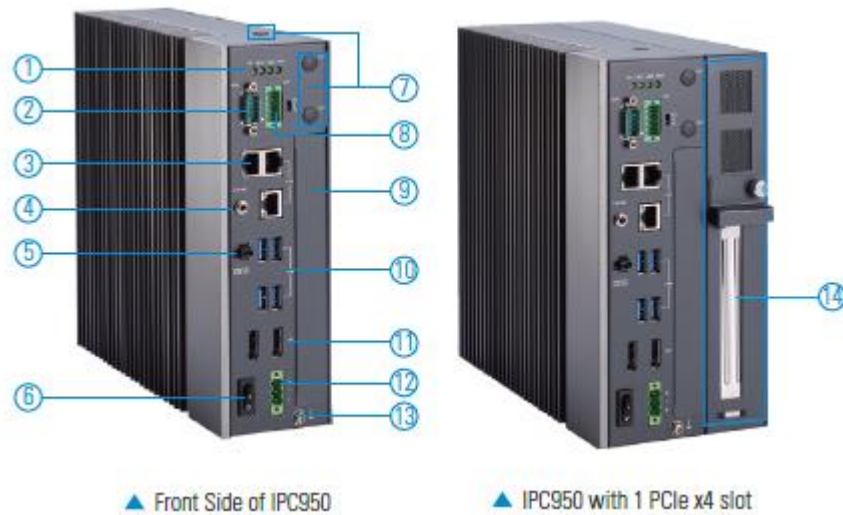

Mark	Description
1	4 x LED
2	1 x RS-232/422/485 (default RS-232)
3	3 x LAN
4	1 x Line out
5	1 x Remote power switch
6	1 x Switch for power on/off
7	3 x Antenna opening
8	8CH DIO
9	Flexible system I/O window
10	4 x USB3.2 Gen.2 (10G)
11	2 x DP++
12	1 x 3-pin terminal block
13	1 x Ground terminal
14	1 x PCIe x4 slot

1.5 Packing List

The package bundled with your IPC950 should contain the following items:

- IPC950 unit x 1
- Screw pack x 1
- Terminal block x 1
- Remote power switch cable x 1
- Antenna plastic isolated washer x 3

If you cannot find this package or any items are missing, please contact Axiomtek distributors immediately.

1.6 System Block Diagram

The following figure shows you the system diagram.

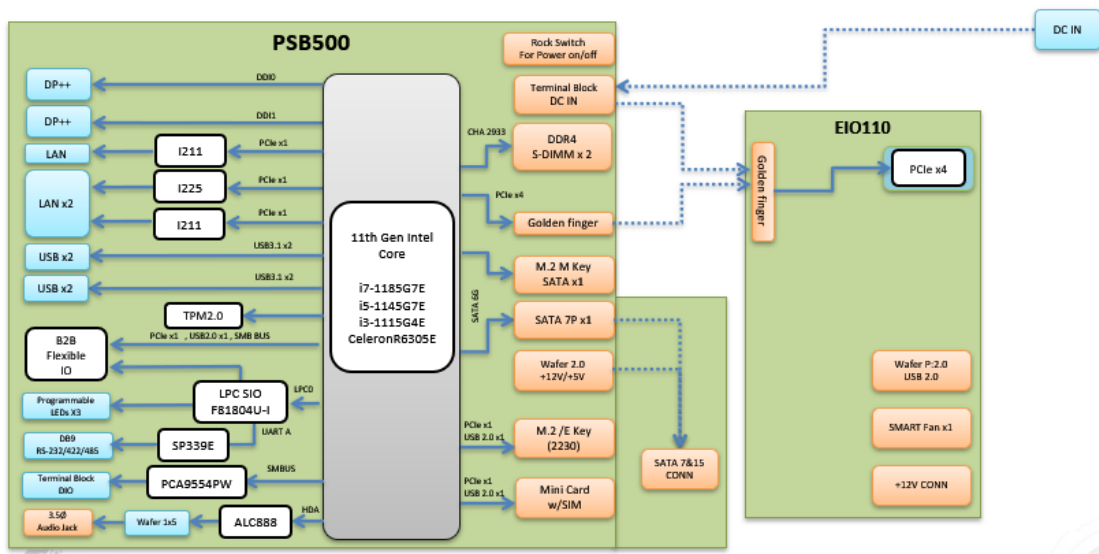

1.7 Jumper Setting Summary

Proper jumper settings configure the IPC950 to meet your application purpose. We are herewith listing a summary table of all jumpers and default settings for onboard devices, respectively.

Jumper	Function/Default Setting	Jumper Setting
JP4	Restore BIOS Optimal Defaults Default: Normal Operation	Short 1-2



Note: How to setup Jumpers

The illustration shows how to set up jumpers. When the jumper cap is placed on pins, the jumper is “closed”, if not, that means the jumper is “open”.

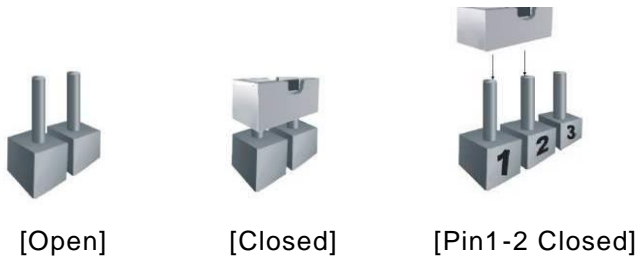

1.7.1 Restore BIOS Optimal Defaults (JP4)

Put the jumper clip on pin 2-3 for a few seconds then move it back to pin 1-2. Doing this procedure can restore BIOS optimal defaults.

Function	Setting
Normal (Default)	1-2
Clear RTC	2-3

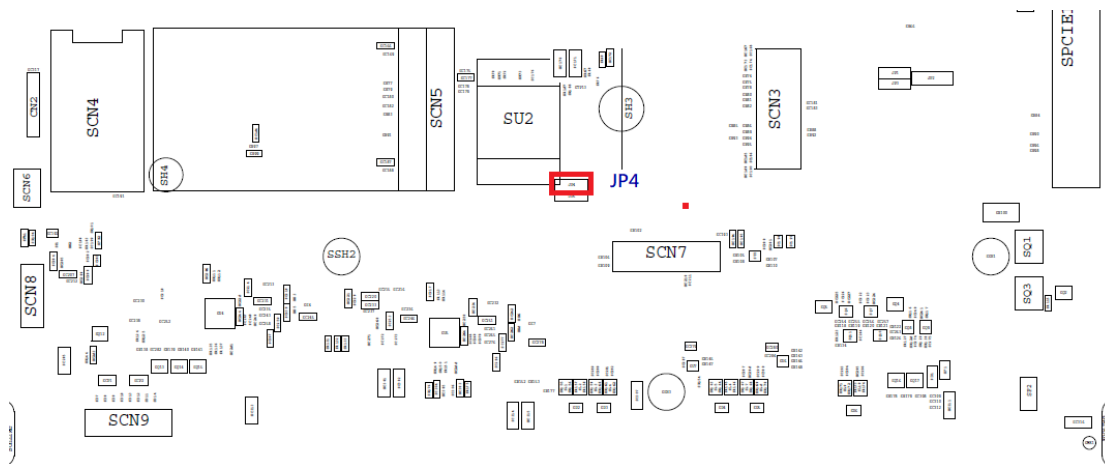
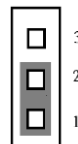

1.8 Connectors

Connectors connect the board with other parts of the system. Loose or improper connection might cause problems. Make sure all connectors are properly and firmly connected. Here is a table summarizing all connectors and buttons on the **IPC950** series.

External Connectors	Section
DC-in Phoenix Power Connector	3.3.1
DisplayPort Connector	3.3.3
Serial Port Connector	3.3.4
USB 3.0 Connector	3.3.5
Ethernet Connector	3.3.6
Audio Connector	3.3.7
ATX Power On/Off Button	3.3.8
Remote Power Switch Connector	3.3.9
AT/ATX Switch	3.3.10
Digital I/O	3.3.11
Front Panel Connector	3.3.12
Internal Connectors	Section
Serial ATA (SATA) Connector	3.3.13
SATA Power Connector	3.3.14
SIM Card Slot	3.3.15
Full-Size Express Mini Card slot	3.3.16
USB 2.0 Connector	3.3.17
M.2 M key Connector (2280)	3.3.18
M.2 E key Connector (2242)	3.3.19

1.8.1 DC-in Phoenix Power Connector

The system supports a 9~36V Phoenix DC-in connector (CN8) for system power input.

Pin	Signal
1	DC +
2	DC -
3	Chassis gnd

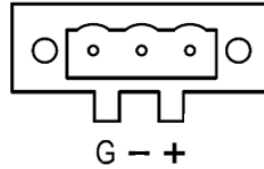

1.8.2 DisplayPort Connector

The IPC950 supports two dual-mode DP interfaces (DP1), which support DP resolution up to 4096x2304 @ 60Hz.

Pin	Signal	Pin	Signal
1	DPB_LANE0	11	GND
2	GND	12	DPB_LANE3#
3	DPB_LANE0#	13	Detect Pin
4	DPB_LANE1	14	GND
5	GND	15	DPB_AUX
6	DPB_LANE1#	16	GND
7	DPB_LANE2	17	DPB_AUX#
8	GND	18	DPB_HPDE
9	DPB_LANE2#	19	GND
10	DPB_LANE3	20	+3.3V

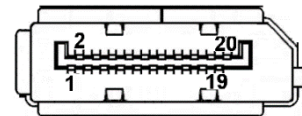

1.8.3 Serial Port Connector

The system has one 9-pin D-sub connector, which supports RS-232/422/485. The default setting is RS-232, and it can be configured to RS422 or RS485 via BIOS settings. Please refer to Section 3 for detailed BIOS settings.

※COM1

Pin	RS-232	RS-422	RS-485
1	DCD, Data Carrier Detect	TX-	Data-
2	RXD, Receive Data	TX+	Data+
3	TXD, Transmit Data	RX+	No use
4	DTR, Data Terminal Ready	RX-	No use
5	GND, Ground	No use	No use
6	DSR, Data Set Ready	No use	No use
7	RTS, Request To Send	No use	No use
8	CTS, Clear To Send	No use	No use
9	RI, Ring Indicator	No use	No use

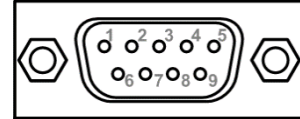

1.8.4 USB 3.2 Connector

The IPC950 supports four USB 3.2 Gen2 (10Gb/s) ports (CN5, CN6), which can be used to install USB peripherals such as scanners, cameras and USB devices. Each USB port is set to use standby power by default, which can be enabled or disabled by GPIOs.

Pin	Signal USB Port 0	Pin	Signal USB Port 1
1	USB_VCC (+5V level standby power)	10	USB_VCC (+5V level standby power)
2	USB_Data-	11	USB_Data-
3	USB_Data+	12	USB_Data+
4	GND	13	GND
5	SSRX-	14	SSRX-
6	SSRX+	15	SSRX+
7	GND	16	GND
8	SSTX-	17	SSTX-
9	SSTX+	18	SSTX+



1.8.5 Ethernet Connector (LAN1~LAN3)

The system supports three Ethernet ports (CN3, CN4): two RJ45 connectors with Intel® i211-AT controller support 10/100/1000 Mbps, while the other RJ45 connector with Intel® i225-LM supports AMT and speed up to 2500Mbps, which is located at the lower side of CN3.

Pin	LAN Signal	Pin	LAN Signal
L1	MDI0+	L5	MDI2+
L2	MDI0-	L6	MDI2-
L3	MDI1+	L7	MDI3+
L4	MDI1-	L8	MDI3-
A	Activity link LED(Yellow) OFF: No link Blinking: Link established; data activity detected		
	Speed LED LAN1: Intel® i225-LM OFF: 10/100Mbps data rate Green: 1Gbps data rate Orange: 2.5Gbps data rate LAN2/LAN3: Intel® i211-AT OFF: 10Mbps data rate Green: 100Mbps data rate Orange: 1Gbps data rate		

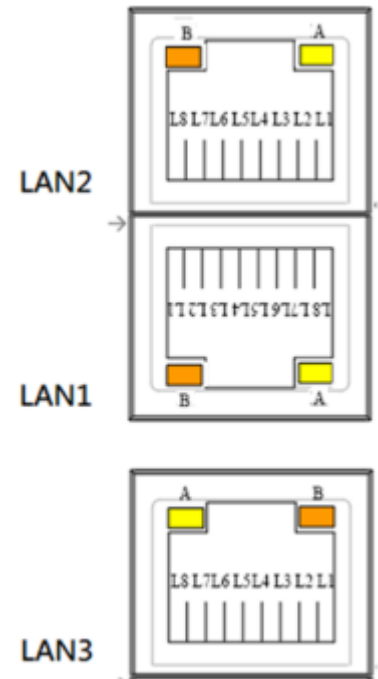

1.8.6 Audio Connector

The IPC950 features one phone jack connector that supports stereo Line Out.

Pin	Signal
1	Line Out



1.8.7 ATX Power On/OFF Button

The system has one ATX power button on the I/O side that allows users to control the IPC950's power on/off state.

Function	Description
On	Turn on/off system
Off	Keep system status

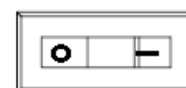

1.8.8 Remote Power Switch Connector

The remote power on/off feature can be achieved by using the 2-pin connector on the system I/O side.

Function	Description
Short(1-2)	Turn on/off system
Open	Keep system status

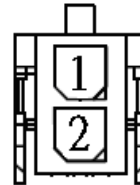

1.8.9 AT/ATX Switch

The system can be automatically powered on without pressing the power button when power input is supplied by setting the AT/ATX switch to AT mode. Auto power-on feature can be achieved by setting this switch.

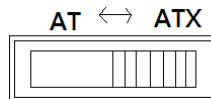

1.8.10 Digital I/O Connector

The IPC950 is equipped with an 8-channel digital I/O connector that meets requirements for the system customary automation control. The digital I/O can be configured to control cash drawers and sense warning signals from an Uninterrupted Power System (UPS), or perform store security control. You may use software programming to control these digital signals.

Pin	Signal	Pin	Signal
1	DIO1	6	DIO5
2	DIO2	7	DIO6
3	DIO3	8	DIO7
4	DIO4	9	DIO8
5	NA	10	GND

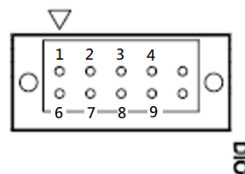

1.8.11 Front Panel LED

The IPC950 implements four LEDs which indicate system status. Solid green on PWR LED indicates the system is on. Flashing green on HDD LED indicates storage activity. Users can program customized system status indication with programmable LED. The system will flash orange while PROCHOT# is asserted, and solid red while THERMTRIP# is asserted on CPU LED.

Pin	Signal
1	CPU LED
2	Programmable LED
3	HDD LED
4	PWR LED



1.8.12 SATA Connector

The IPC950 has one Serial Advanced Technology Attachment (Serial ATA or SATA) 3.0 port (CN11) with 6Gb/s performance. This interface is for connecting to devices such as hard disk drives.

Pin	Signal
1	GND
2	SATA_TX+
3	SATA_TX-
4	GND
5	SATA_RX-
6	SATA_RX+
7	GND

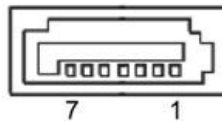

1.8.13 SATA Power Connector

The SATA power connector (CN12) provides +12V and +5V power for 2.5" HDD or SSD devices.

Pin	Signal
1	+12V level
2	GND
3	GND
4	+5V level

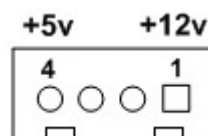

1.8.14 SIM Card Slot

The IPC950 includes one SIM slot (SCN4) on the bottom side of the system for inserting the SIM Card. It is mainly used in 3G/LTE wireless network applications on SCN5.

Pin	Signal
1	PWR
2	RST
3	CLK
4	NC
5	GND
6	VPP
7	I/O
8	NC

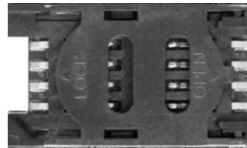

1.8.15 Full-Size PCI Express Mini Card Slot

The IPC950 provides one full-size PCI-Express Mini Card slot, which supports both PCI-Express and USB 2.0 signals and complies with PCI-Express Mini card specification version 1.2.

Pin	Signal	Pin	Signal
1	WAKE#	2	+3.3VSB
3	No use	4	GND
5	No use	6	+1.5V
7	CLKREQ#	8	No use
9	GND	10	No use
11	REFCLK-	12	No use
13	REFCLK+	14	No use
15	GND	16	No use
17	No use	18	GND
19	No use	20	W_DISABLE#
21	GND	22	PERST#
23	PE_RXN8	24	+3.3VSB
25	PE_RXP8	26	GND
27	GND	28	+1.5V
29	GND	30	SMB_CLK
31	PE_TXN8	32	SMB_DATA
33	PE_TXP8	34	GND
35	GND	36	USB_D6-
37	GND	38	USB_D6+
39	+3.3VSB	40	GND

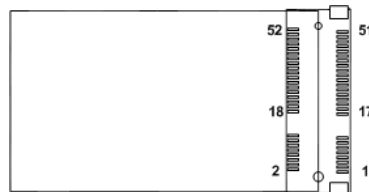

41	+3.3VSB	42	No use
43	GND	44	No use
45	No use	46	No use
47	No use	48	+1.5V
49	No use	50	GND
51	No use	52	+3.3VSB

1.8.16 USB 2.0 Connector (CN9)

The Universal Serial Bus connectors are compliant with USB 2.0 (480Mbps), ideal for installing USB peripherals such as the keyboard, mouse, scanner, etc.

Pin	Signal USB Port
1	USB VCC (+5V level)
2	USB #5_D-
3	USB #5_D+
4	Ground (GND)

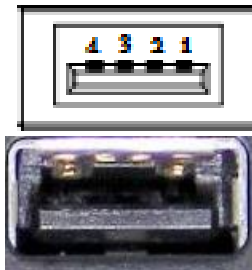

1.8.17 M.2 B+M KEY 2280 Connector (SCN1)

The IPC950 provides one M.2 B+M key 2280 connector (SCN1), which supports Serial Advanced Technology Attachment (Serial ATA or SATA) 3.0 port interface with 6Gb/s performance.

Pin	Signal	Pin	Signal
1	GND	2	+3.3VS
3	GND	4	+3.3VS
5	No use	6	No use
7	No use	8	No use
9	GND	10	M2_SATA_LED
11	No use	12	+3.3VS
13	No use	14	+3.3VS
15	GND	16	+3.3VS
17	No use	18	+3.3VS
19	No use	20	No use
21	GND	22	No use
23	No use	24	No use

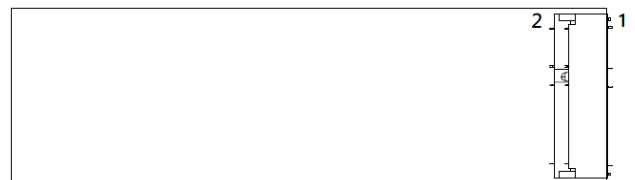

25	No use	26	No use
27	GND	28	No use
29	No use	30	No use
31	No use	32	No use
33	GND	34	No use
35	No use	36	No use
37	No use	38	DEVSLP1
39	GND	40	No use
41	SATA1_RXP	42	No use
43	SATA1_RXN	44	No use
45	GND	46	No use
47	SATA1_TXN	48	No use
49	SATA1_TXP	50	No use
51	GND	52	No use
53	No use	54	No use
55	No use	56	No use
57	GND	58	No use
59		60	No use
61		62	No use
63		64	No use
65		66	No use
67	No use	68	No use
69	No use	70	GND
71	GND	72	GND
73	GND	74	GND
75	GND		

1.8.18 M.2 E-KEY 2230 Connector

The IPC950 provides one M.2 E key 2230 connector (SCN3), which supports both PCI-E and USB 2.0 signals for the M.2 wireless module.

Pin	Signal	Pin	Signal
1	GND	2	+3.3V_SBY
3	USBP_7P	4	+3.3V_SBY
5	USBP_7N	6	No use
7	GND	8	No use
9	No use	10	M2_SATA_LED
11	No use	12	No use
13	GND	14	No use
15	No use	16	No use
17	No use	18	GND
19	GND	20	UART_WAKE#
21	No use	22	UART_TXD
23	No use	24	
25		26	
27		28	
29		30	
31		32	UART_RXD
33	GND	34	UART_RTS
35	PCIE_TX_DP7	36	UART_CTS
37	PCIE_TX_DN7	38	
39	GND	40	
41	PCIE_RX_DP7	42	
43	PCIE_RX_DN7	44	
45	GND	46	
47	CK_100M_DP1	48	
49	CK_100M_DN1	50	SUSCLK
51	GND	52	PERST0#
53	CLKREQ#	54	W_DISABLE2#
55	PCIE_WAKE_N	56	W_DISABLE1#
57	GND	58	I2C_DATA
59		60	I2C_CLK
61		62	No use
63	GND	64	No use
65		66	No use
67		68	No use

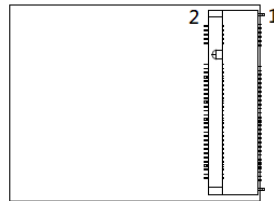

69	GND	70	No use
71		72	+3.3V_SBY
73		74	+3.3V_SBY
75	GND		

1.8.19 Flexible IO - COM I/O Card Connector (AX93511)

The system has four serial ports. COM2~COM5 are RS-232/422/485 ports.

*RS-232/422/485 can be configured via BIOS settings

※COM2,COM3,COM4,COM5

Pins	RS-232	RS-422	RS-485
1	DCD, Data Carrier Detect	TX-	Data-
2	RXD, Receive Data	TX+	Data+
3	TXD, Transmit Data	RX+	No use
4	DTR, Data Terminal Ready	RX-	No use
5	GND, Ground	No use	No use
6	DSR, Data Set Ready	No use	No use
7	RTS, Request To Send	No use	No use
8	CTS, Clear To Send	No use	No use
9	RI, Ring Indicator	No use	No use

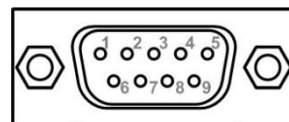

1.8.20 Flexible IO – Isolated COM & DIO I/O Card (AX93512)

The system has an optional module to support COM2~COM3, which are RS-232/422/485 with isolated 1.5KVDC protection and DIO1~DIO2 8-in/8-out isolated 1.5KVDC DIO ports. Please refer to Chapter 4 for the details of BIOS settings.

※COM2,COM3,DIO1,DIO2

CN1 (COM2)& CN2(COM3)			
Pins	RS-232	RS-422	RS-485
1	DCD, Data Carrier Detect	TX-	Data-
2	RXD, Receive Data	TX+	Data+
3	TXD, Transmit Data	RX+	No use
4	DTR, Data Terminal Ready	RX-	No use
5	GND, Ground	No use	No use
6	DSR, Data Set Ready	No use	No use
7	RTS, Request To Send	No use	No use
8	CTS, Clear To Send	No use	No use
9	RI, Ring Indicator	No use	No use
10	GND_EARTH	No use	No use

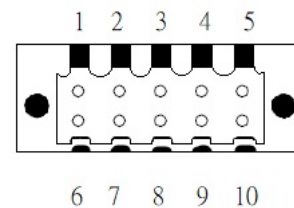

CN3(DIO1)		CN4(DIO2)	
Pin	Function	Pin	Function
1	Common1 PWR+	1	Common2 PWR+
2	DO10	2	DO20
3	DO11	3	DO21
4	DO12	4	DO22
5	DO13	5	DO23
6	Common1 PWR-	6	Common2 PWR-
7	External1 Power	7	External2 Power
8	DI10	8	DI20
9	DI11	9	DI21
10	DI12	10	DI22
11	DI13	11	DI23
12	Isolation1 GND	12	Isolation2 GND

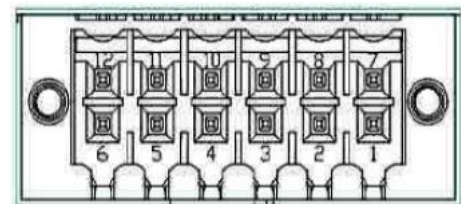

Digital I/O Specification (per port)

- **Isolated Digital Input**

The figure shows how to connect between an external input source and the system.

Each of the isolated digital input channels accepts 0~30 VDC with sink type and source type.

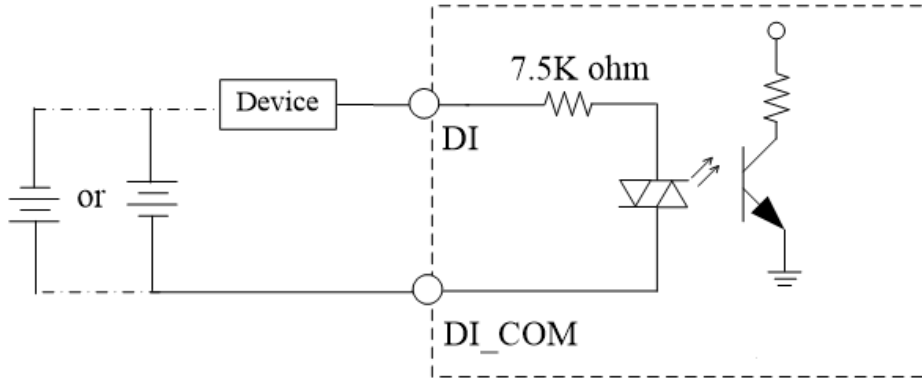

- **Isolated Digital Output**

The figure shows how to connect between an output channel and the system.

If an external voltage 5~30 VDC is applied to an isolated output channel, the current will flow from the external voltage source to the system.

Please note that the current flowing through each DO channel should not exceed 200 mA.

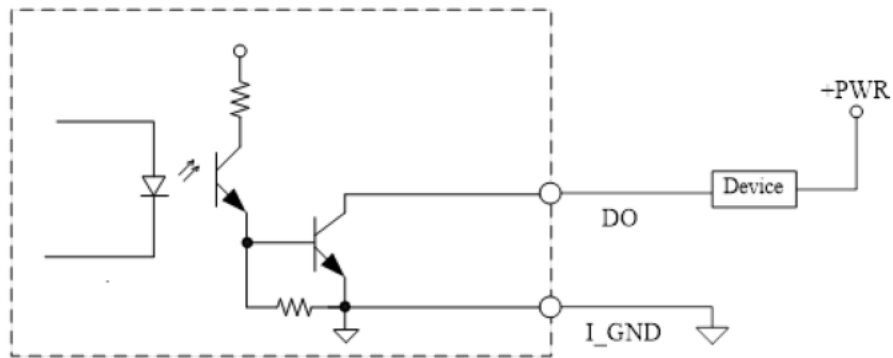

1.8.21 Flexible IO – Isolated COM x4 I/O Card (AX93516)

The system has an optional module with four serial ports. COM2~COM5 are RS-232/422/485 with isolated 2KV ports. Please refer to Chapter 4 for the details of BIOS settings.

※COM2,COM3,COM4,COM5

Pins	RS-232	RS-422	RS-485
1	DCD, Data Carrier Detect	TX-	Data-
2	RXD, Receive Data	TX+	Data+
3	TXD, Transmit Data	RX+	No use
4	DTR, Data Terminal Ready	RX-	No use
5	GND, Ground	No use	No use
6	DSR, Data Set Ready	No use	No use
7	RTS, Request To Send	No use	No use
8	CTS, Clear To Send	No use	No use
9	RI, Ring Indicator	No use	No use
10	GND_EARTH	No use	No use

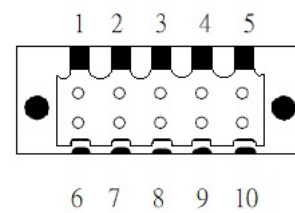

1.8.22 Flexible IO- USB3.0x2 & COMx2(RS232/422/485) & LAN(AX93519)

The system has an optional module to support two USB 2.0 ports, two RS232/422/485, and one Gigabit LAN. Please refer to Chapter 4 for the details of BIOS settings.

➤ AX93519 2 x RS232/422/485 + 1 GE LAN(i211AT) + 2 USB 2.0

Pins	Signal USB Port 0	Pins	Signal USB Port 1
1	USB_VCC (+5V level standby power)	1	USB_VCC (+5V level standby power)
2	USB_Data2-	2	USB_Data3-
3	USB_Data2+	3	USB_Data3+
4	GND	4	GND
5	Reserve	5	Reserve
6	Reserve	6	Reserve
7	GND	7	GND
8	Reserve	8	Reserve
9	Reserve	9	Reserve

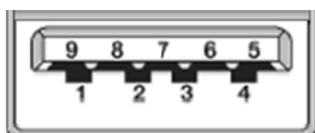

The system has two serial ports. COM2~COM3 are RS-232/422/485 ports. Please refer to Chapter 3 for the details of BIOS settings.

※COM2,COM3

Pins	RS-232	RS-422	RS-485
1	DCD, Data Carrier Detect	TX-	Data-
2	RXD, Receive Data	TX+	Data+
3	TXD, Transmit Data	RX+	No use
4	DTR, Data Terminal Ready	RX-	No use
5	GND, Ground	No use	No use
6	DSR, Data Set Ready	No use	No use
7	RTS, Request To Send	No use	No use
8	CTS, Clear To Send	No use	No use
9	RI, Ring Indicator	No use	No use

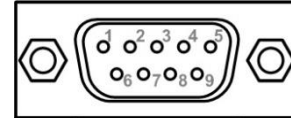

The system has two RJ-45 connectors: a LAN Ethernet connection can be established by plugging one end of the Ethernet cable into this RJ-45 connector and the other end (phone jack) to a 1000/100/10-Base-T hub.

Pins	1000 Base-T	100/10 Base-T	Descriptions
L1	BI_DA+	TX+	Bidirectional or Transmit Data+
L2	BI_DA-	TX-	Bidirectional or Transmit Data-
L3	BI_DB+	RX+	Bidirectional or Receive Data+
L4	BI_DC+	N.C.	Bidirectional or Not Connected
L5	BI_DC-	N.C.	Bidirectional or Not Connected
L6	BI_DB-	RX-	Bidirectional or Receive Data-
L7	BI_DD+	N.C.	Bidirectional or Not Connected
L8	BI_DD-	N.C.	Bidirectional or Not Connected
A	Active Link LED (Yellow) Off: No link Blinking: Data activity detected		
B	Speed LED 1000: Orange 100: Green 10: OFF		

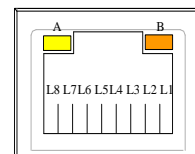

This page is intentionally left blank.

SECTION 2 HARDWARE INSTALLATION

The IPC950 products are convenient for your various hardware configurations, such as the memory module, HDD (Hard Disk Drive) and PCIe card. Chapter 2 will show you how to install these hardware parts.

Procedure of Installation:

- Step 1** Turn off the system.
- Step 2** Disconnect the power connector.
- Step 3** Loosen seven screws and follow the direction of “” to remove the back cover from the chassis.

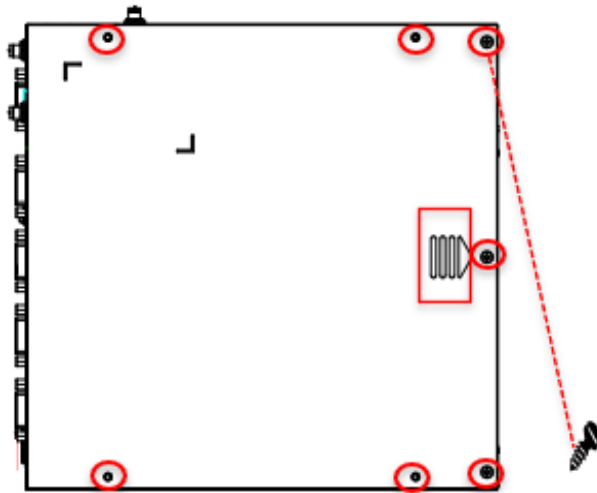

2.1 Installing the Memory Module

- Step 1** Loosen four screws and remove the bracket.

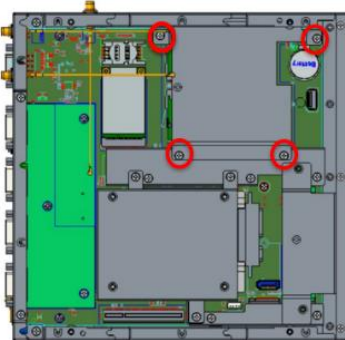

Step 2 Rip the mylar from thermal pads which are stuck on the system cover and main board. Install the memory module into the socket and push it firmly down until it is fully seated. The socket latches are clipped onto the edges of the memory module.

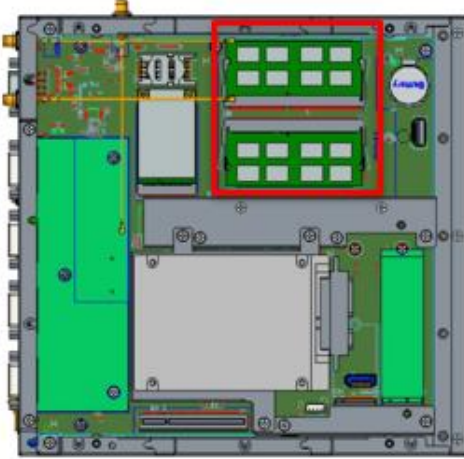

Step 3 After installing the memory modules, screw the bracket and close the cover back to the chassis and fasten all screws.

2.2 Installing the Hard Disk Drive

The IPC950 offers an internal drive bay for users to install HDD/SSD. Please follow the steps to install.

Step 1 Loosen three screws and remove the bracket.

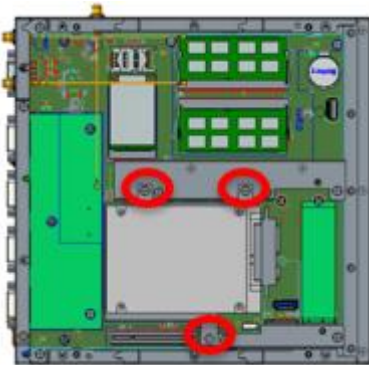

Step 2 Screw the HDD/SDD to the bracket with 3 screws.

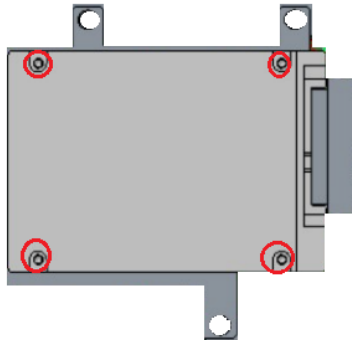

- Step 3** Screw the HDD/SSD bracket back to the system and plug the data and power cables to HDD/SSD. Installation is complete.

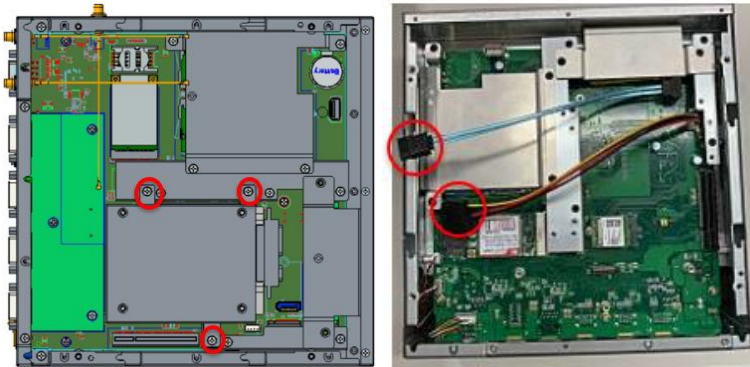

2.3 Installing the NVMe SSD

The IPC950 offers a M.2 B+M key socket for users to install NVMe SSD. Please follow the steps to install.

- Step 1** Loosen two screws and remove the bracket.

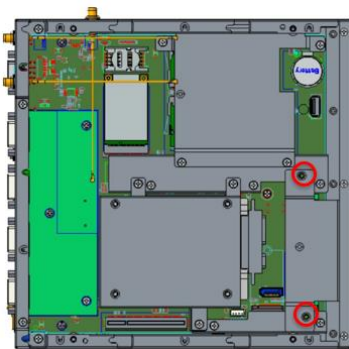

- Step 2** Rip the mylar from thermal pads which are stuck on the system cover and main board. Install the SSD into the socket and screw a screw to fix it.

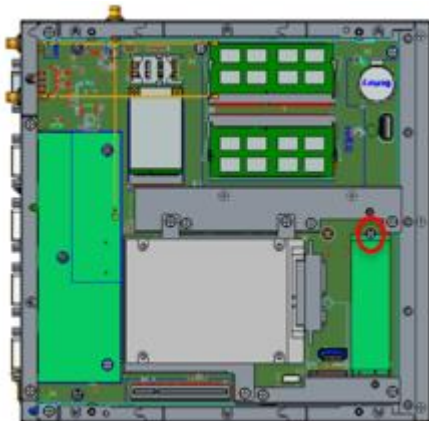

- Step 3** Fix the bracket into the system. Installation is complete.

2.4 Installing the M.2 Key E Module

The IPC950 offers an M.2 key E socket for users to install a wireless module. When installing the wireless LAN card, refer to the following instructions and illustration:

Step 1 Loosen three screws and remove the bracket.

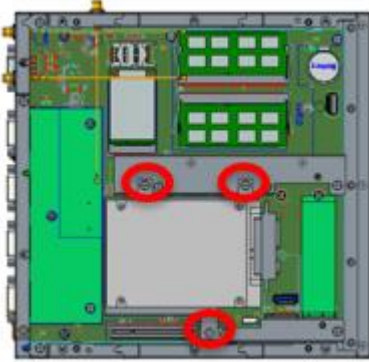

Step 2 Install the wireless module into the socket and screw a screw to fix it.



Step 3 Please take the plastic antenna isolated washer out of the accessory box. Put a washer into an antenna cable.

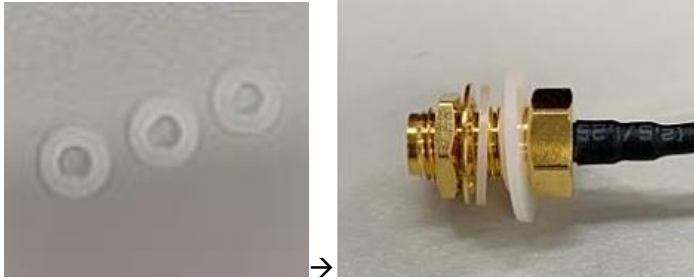

Step 4 Connect the antenna cables to the wireless LAN card.



Step 5 The IPC950 supports three antenna openings, please remove the antenna plugs from the cover and Install the antenna cables, then screw the bracket. Installation is completed.



2.5 Installing the Mini PCIe Module

The IPC950 offers a mini PCIe socket in the main board, then install the wireless module to the socket and screw a screw to fix it.

Step 1 Find the mini PCI socket in the main board, then install the wireless module to the socket and screw a screw to fix it.

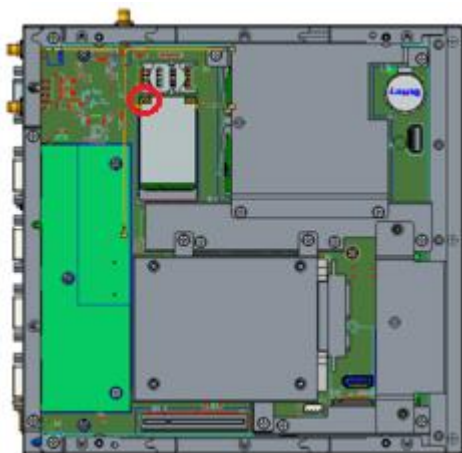

Note: When installing a half-size mini card, please use the extended bracket to secure the card in place.

Step 2 Connect the antenna cables to the wireless LAN card.

Step 3 The IPC950 supports three antenna openings. Please remove the antenna plugs from the cover and Install the antenna cable. Installation is complete.



2.6 Installing the Flexible I/O Module

The IPC50 provides four flexible I/O modules for further expansion needs. The procedure of installing the flexible I/O module into the system is instructed below.

Step 1 Loosen two screws and remove the blank I/O cover.

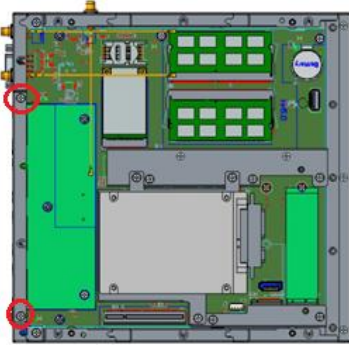

Step 2 Find the flexible I/O connector on the main board. Align the flexible I/O module with the slot, press the card into the connector until it is firmly seated, and then screw its bracket to the system. Installation is complete.

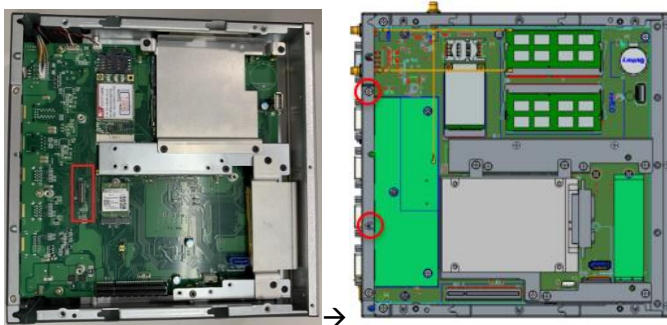

2.7 Mounting

The IPC950 provides a DIN rail kit, a bookshelf bracket, and a wall mount kit for optional selection.

DIN rail mount



Step 1 Screws the below two parts together with seven screws.

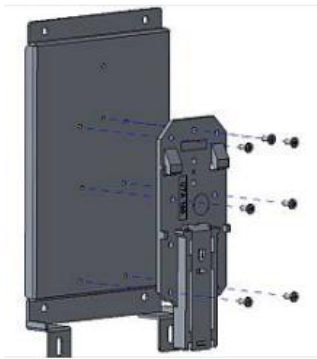

Step 2 Fasten the DIN rail to the chassis with four screws. Installation is complete.



Bookshelf mount



Step 3 Fasten the book shelf bracket to the chassis with four screws. Installation is complete.

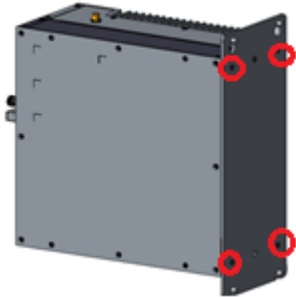

Wall mount

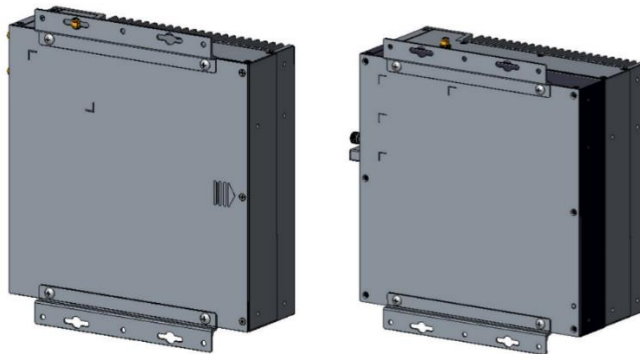

Step 4 Fasten the wall mount kit to the chassis with four screws. Installation is complete.

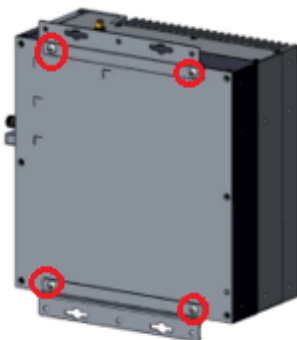

Screw

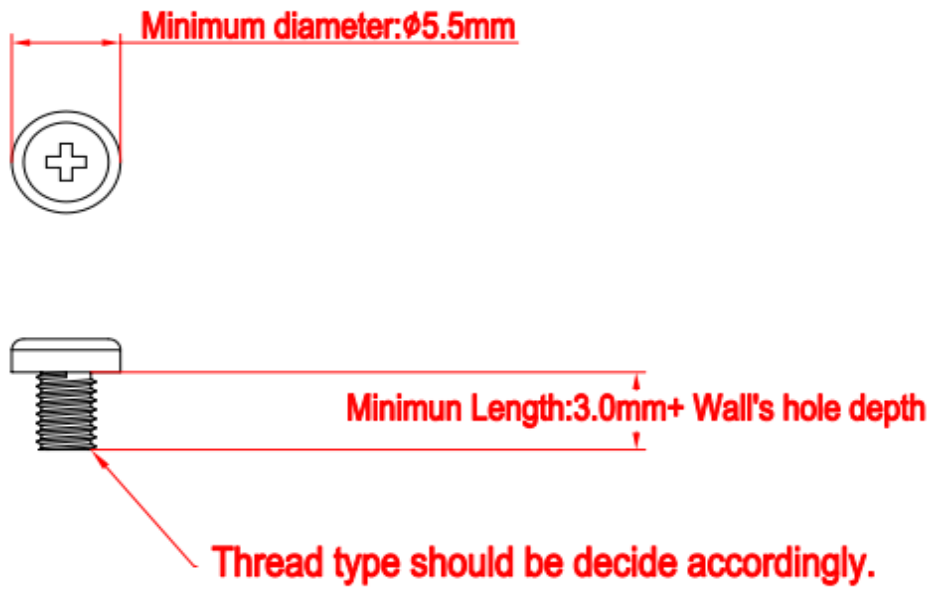

SECTION 3

AMI BIOS UTILITY

The AMI UEFI BIOS provides users with a built-in setup program to modify basic system configuration. All configured parameters are stored in a 16MB flash chip to save the setup information whenever the power is turned off. This chapter provides users with detailed description about how to set up basic system configuration through the AMI BIOS setup utility.

3.1 Starting

To enter the setup screens, follow the steps below:

1. Turn on the computer and press the key immediately.
2. After you press the key, the main BIOS setup menu displays. You can access the other setup screens from the main BIOS setup menu, such as the Advanced and Chipset menus.



***Note:** If your computer cannot boot after making and saving system changes with Setup, you can restore BIOS optimal defaults by setting JP1 (see section 1.6.2).*

It is strongly recommended that you should avoid changing the chipset's defaults. Both AMI and your system manufacturer have carefully set up these defaults that provide the best performance and reliability.

3.2 Navigation Keys

The BIOS setup/utility uses a key-based navigation system called hot keys. Most of the BIOS setup utility hot keys can be used at any time during the setup navigation process. These keys include <F1>, <F2>, <Enter>, <ESC>, <Arrow> keys, and so on.



Note: Some of the navigation keys may differ from one screen to another.

Hot Keys	Description
→← Left/Right	The Left and Right <Arrow> keys allow you to select a setup screen.
↑↓ Up/Down	The Up and Down <Arrow> keys allow you to select a setup screen or sub-screen.
+– Plus/Minus	The Plus and Minus <Arrow> keys allow you to change the field value of a particular setup item.
Tab	The <Tab> key allows you to select setup fields.
F1	The <F1> key allows you to display the General Help screen.
F2	The <F2> key allows you to Load Previous Values.
F3	The <F3> key allows you to Load Optimized Defaults.
F4	The <F4> key allows you to save any changes you have made and exit Setup. Press the <F4> key to save your changes.
Esc	The <Esc> key allows you to discard any changes you have made and exit the Setup. Press the <Esc> key to exit the setup without saving your changes.
Enter	The <Enter> key allows you to display or change the setup option listed for a particular setup item. The <Enter> key can also allow you to display the setup sub- screens.

3.3 Main Menu

The first time you enter the setup utility, you will be in the Main setup screen. You can always return to the Main setup screen by selecting the Main tab. System Time/Date can be set up as described below. The Main BIOS setup screen is shown below.

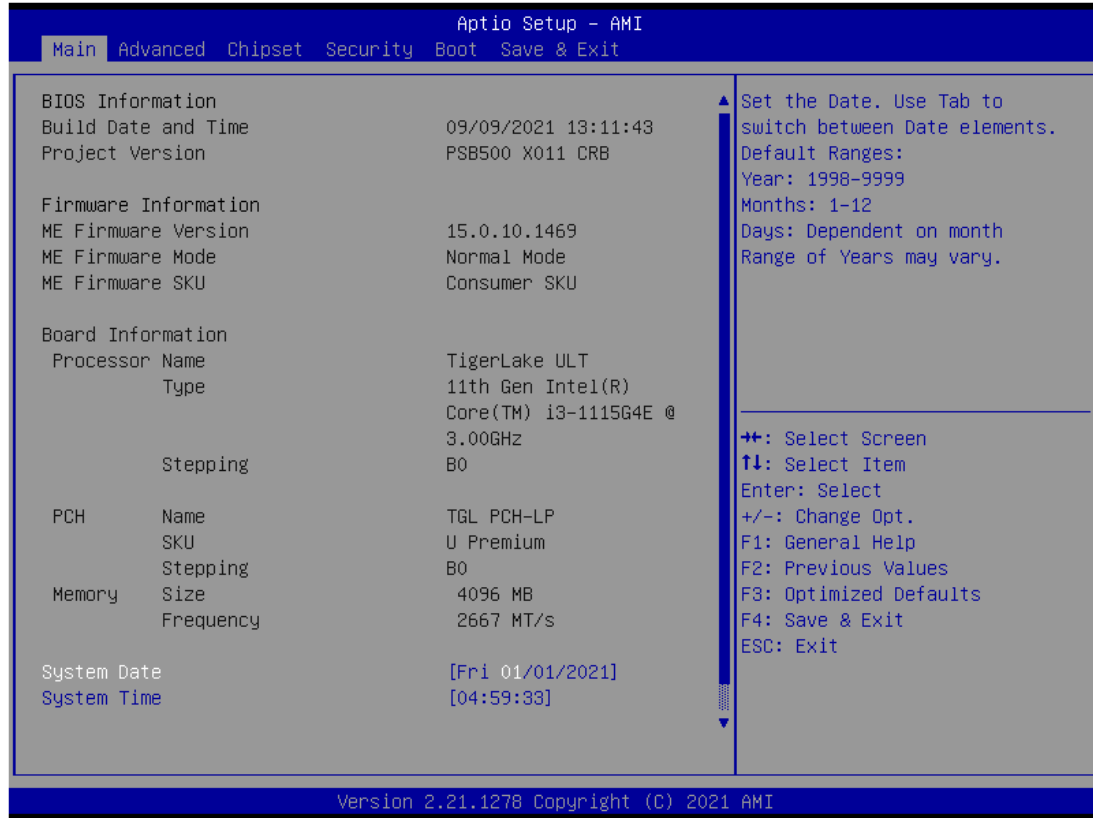

- **System Date/Time**

Use this option to change the system time and date. Highlight System Time or System Date using the <Arrow> keys. Enter new values through the keyboard. Press the <Tab> key or the <Arrow> keys to move between fields. The date must be entered in MM/DD/YY format. The time is entered in HH:MM:SS format.

3.4 Advanced Menu

The Advanced menu allows users to configure the CPU and other system devices. You can select any of the items in the left frame of the screen to go to the sub menus.

For items marked with “▶”, please press <Enter> for more options.

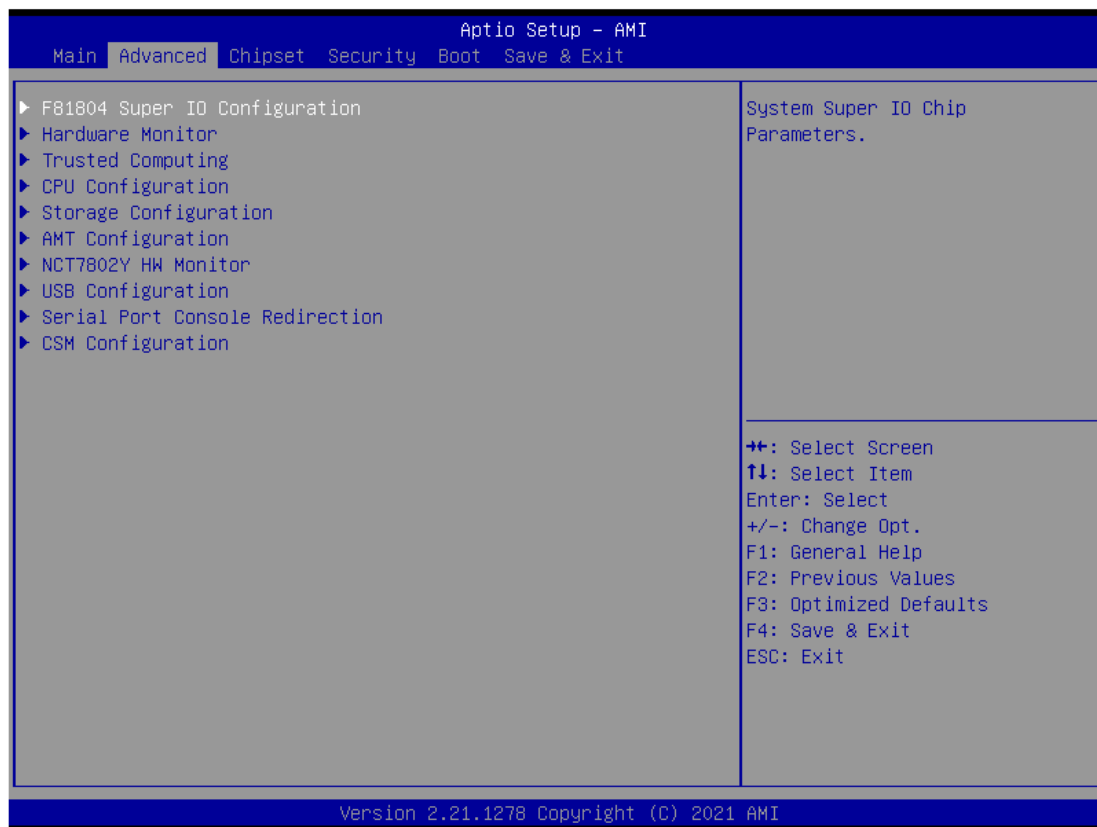

- **HW Monitor**

This screen monitors hardware health.

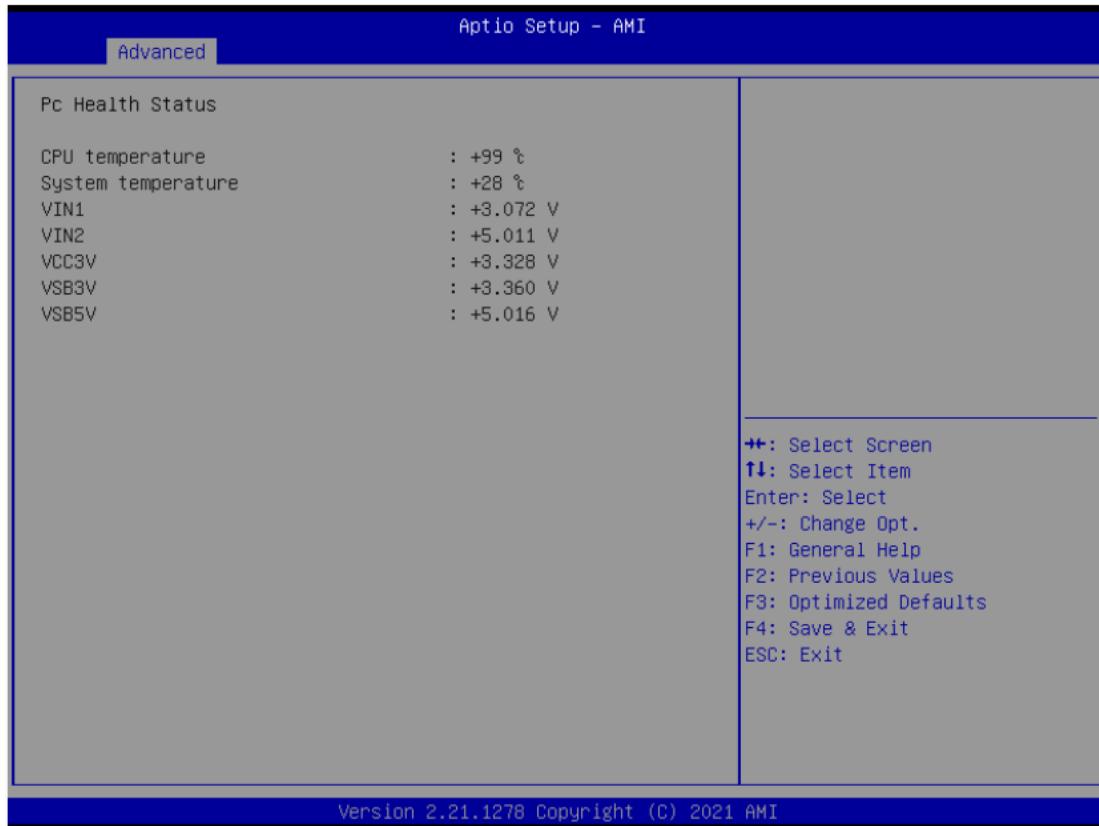

- **NCT7802Y HW Monitor**

This screen monitors the hardware health of the EIO110 PCIe x4 riser card.

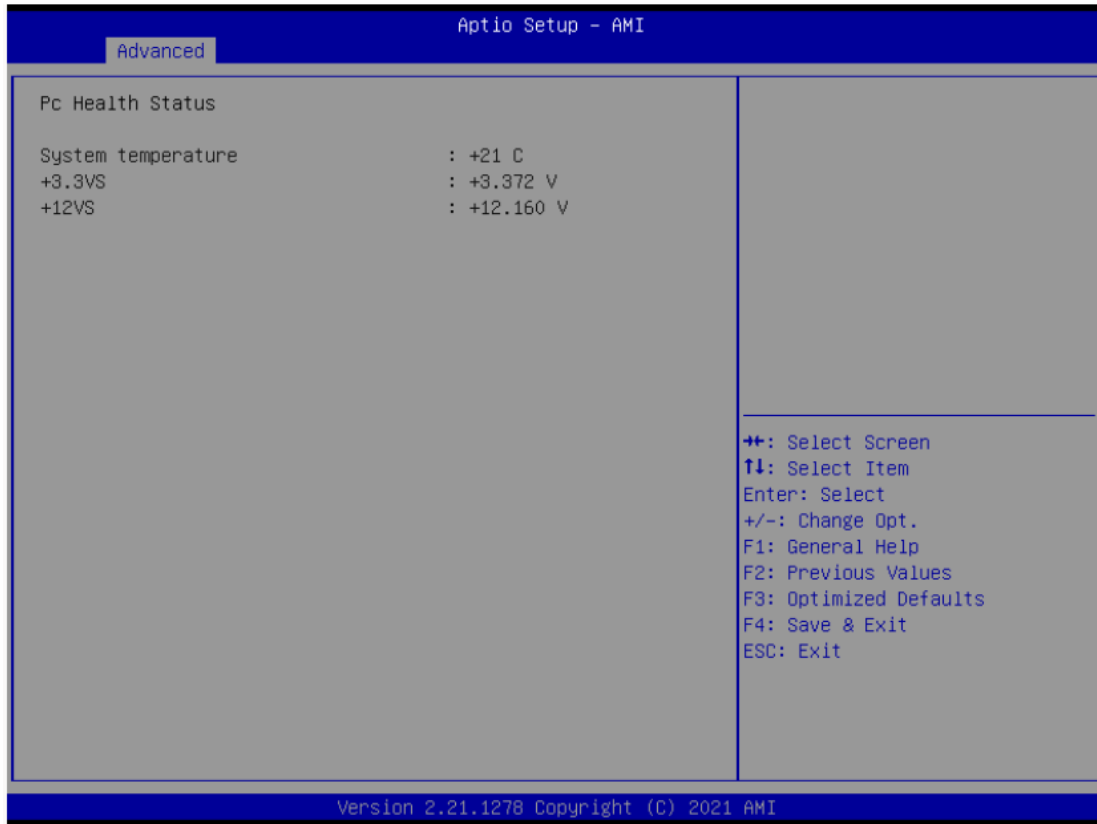

- **Trusted Computing**

Select Security Device Support to enable or disable the TPM function.



● **CPU Configuration**

This screen shows the CPU configuration, where you can change the value of the selected option.

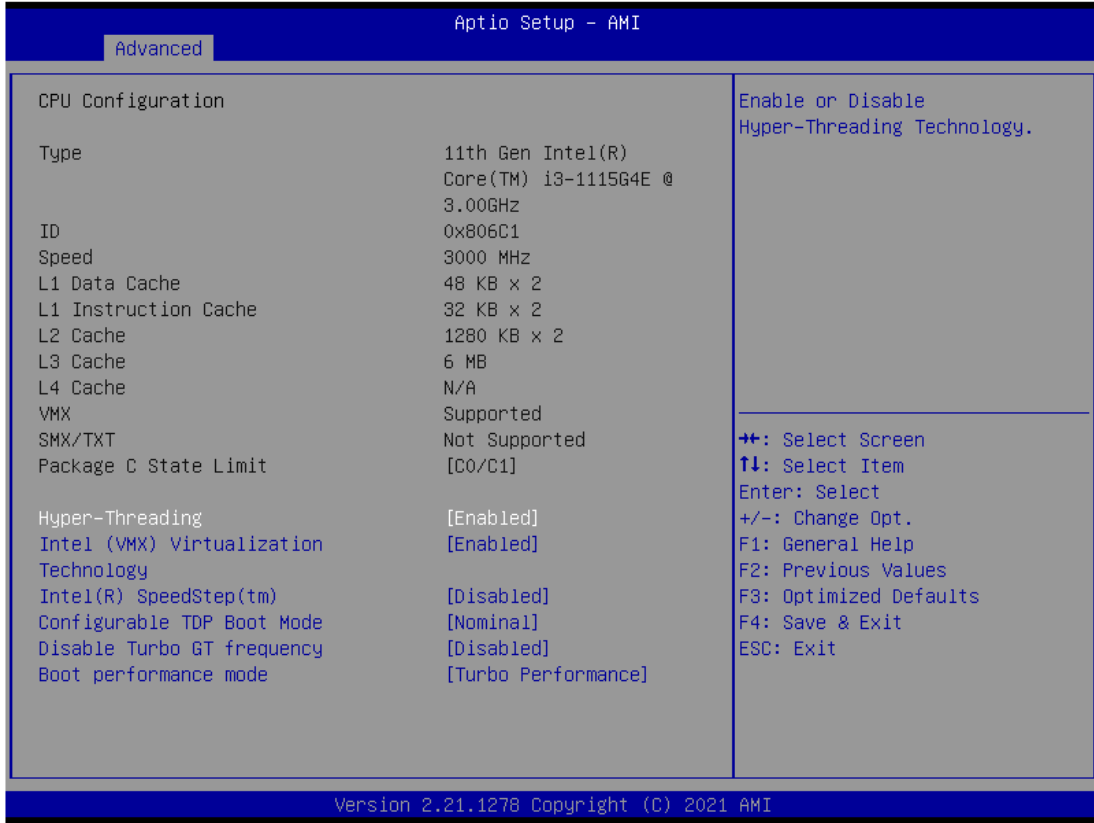

➤ **Intel Virtualization Technology**

This item allows a hardware platform to run multiple operating systems separately and simultaneously, enabling one system to virtually function as several systems.

- **SATA and RST Configuration**

You can read the current installed hardware configurations from those SATA ports in the SATA and RST Configuration menu. During system boot up, BIOS will detect the present SATA devices automatically.

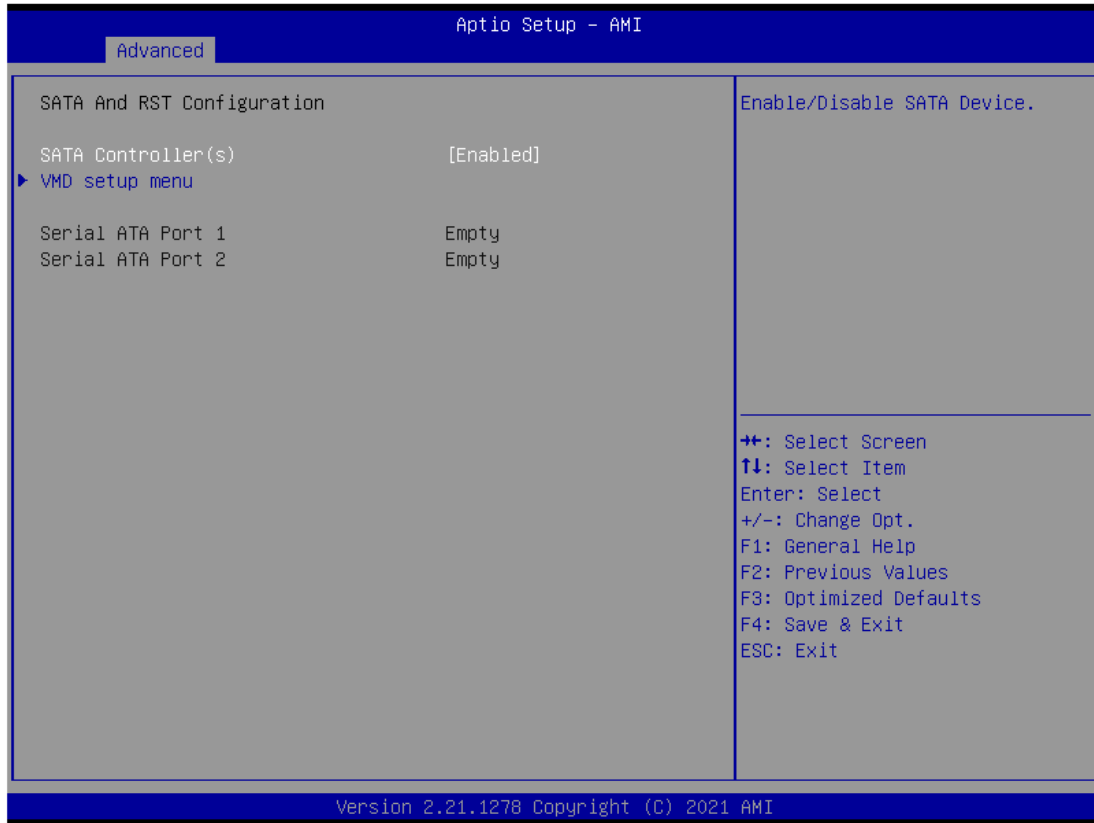

- **AMT Configuration**

Enable or disable Active Management Technology BIOS features. The default is disabled.

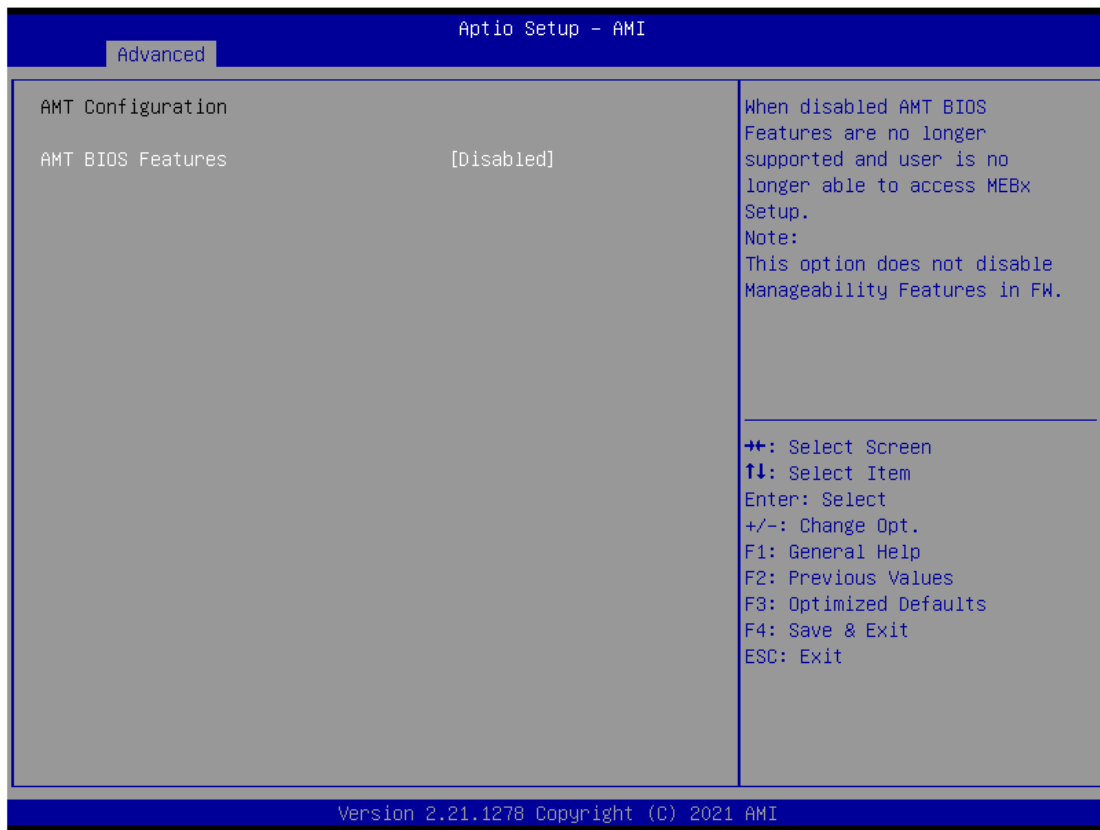

- **USB Configuration**

USB configuration can be configured here by selecting and changing each item. A description of the selected item appears on the right side of the screen.

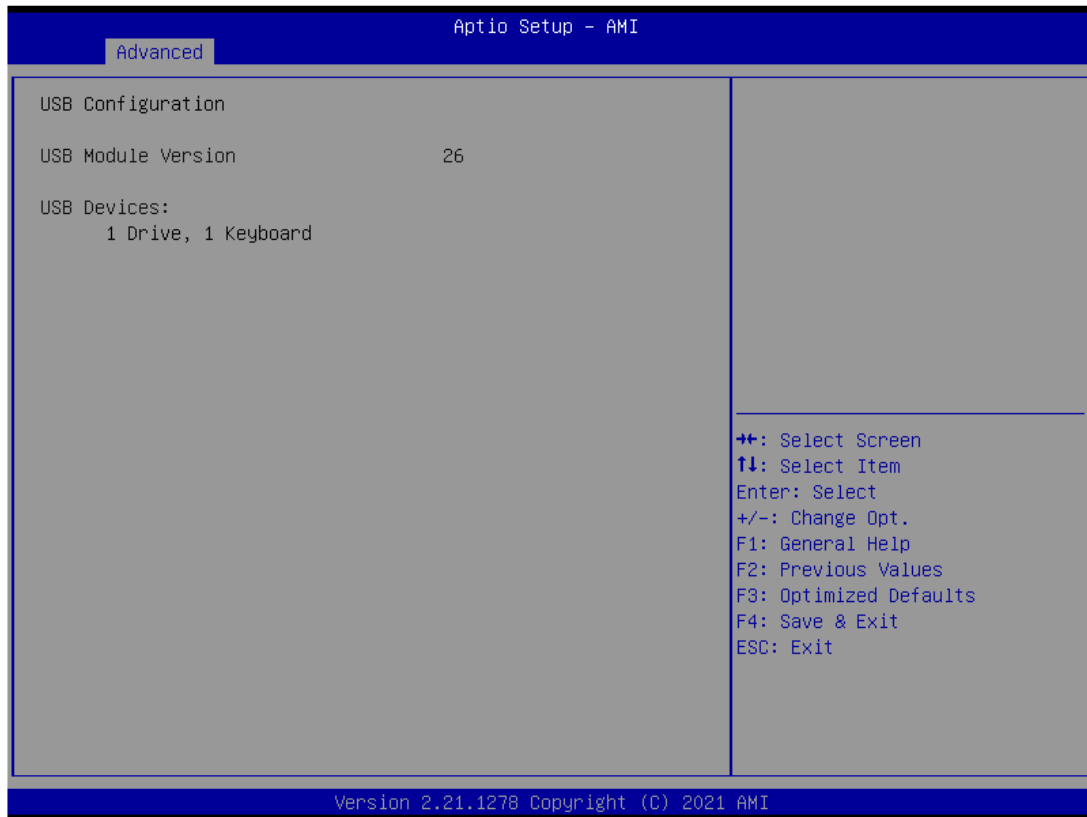

- **USB Devices**

Display all detected USB devices.

- **F81804 Super IO Configuration**

You can use this screen to select options for the Super IO Configuration and change the value of the selected option. A description of the selected item appears on the right side of the screen. For items marked with “▶”, please press <Enter> for more options.

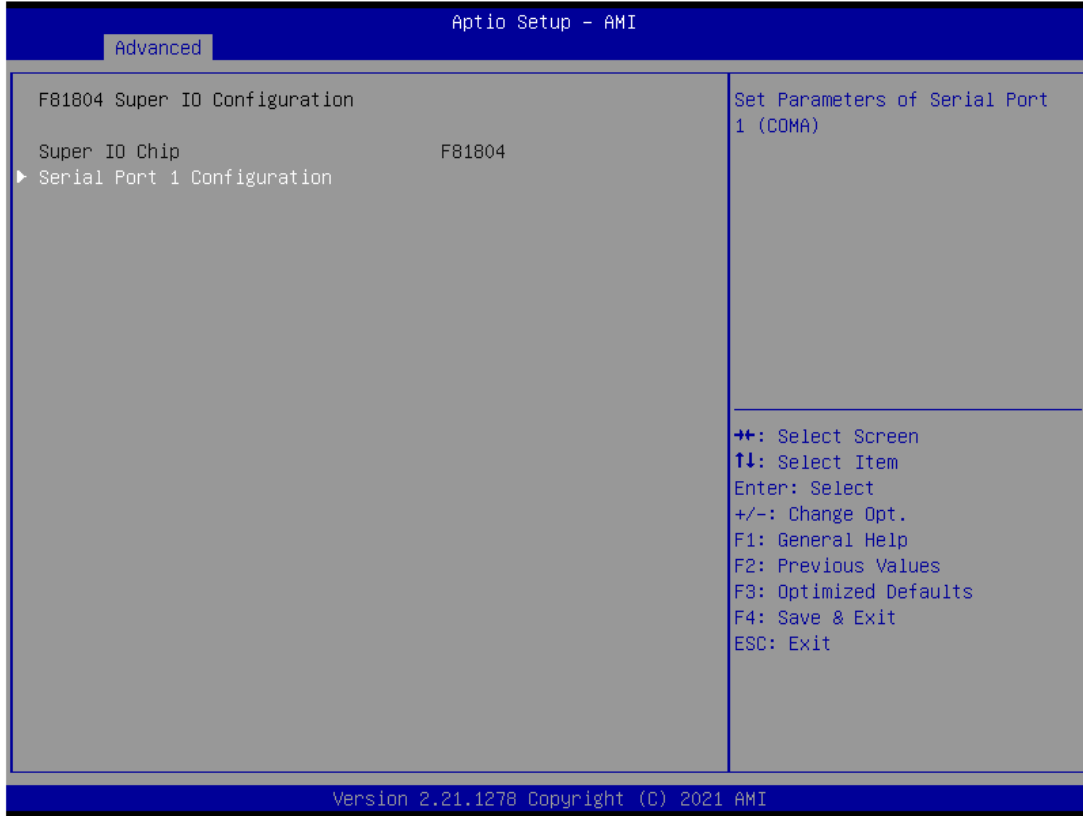

- **Serial Port 1 Configuration**

Use this item to set parameters of serial port 1.

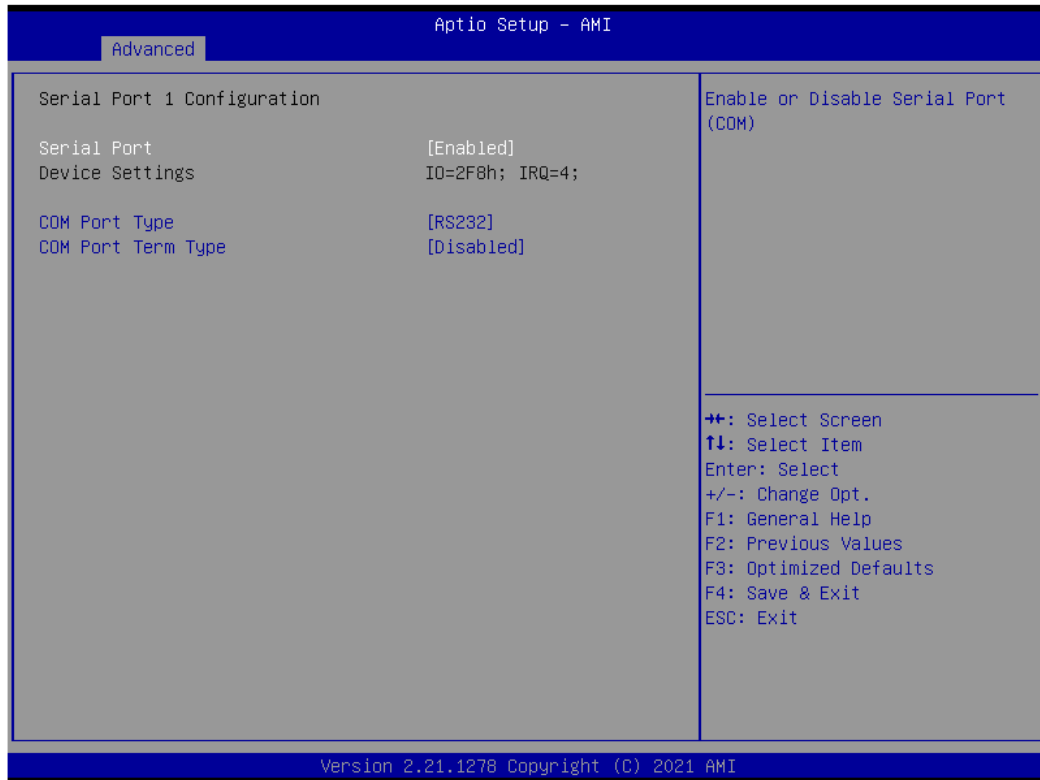

- **Serial Port Console Redirection**

This screen allows you to set serial port console redirection.

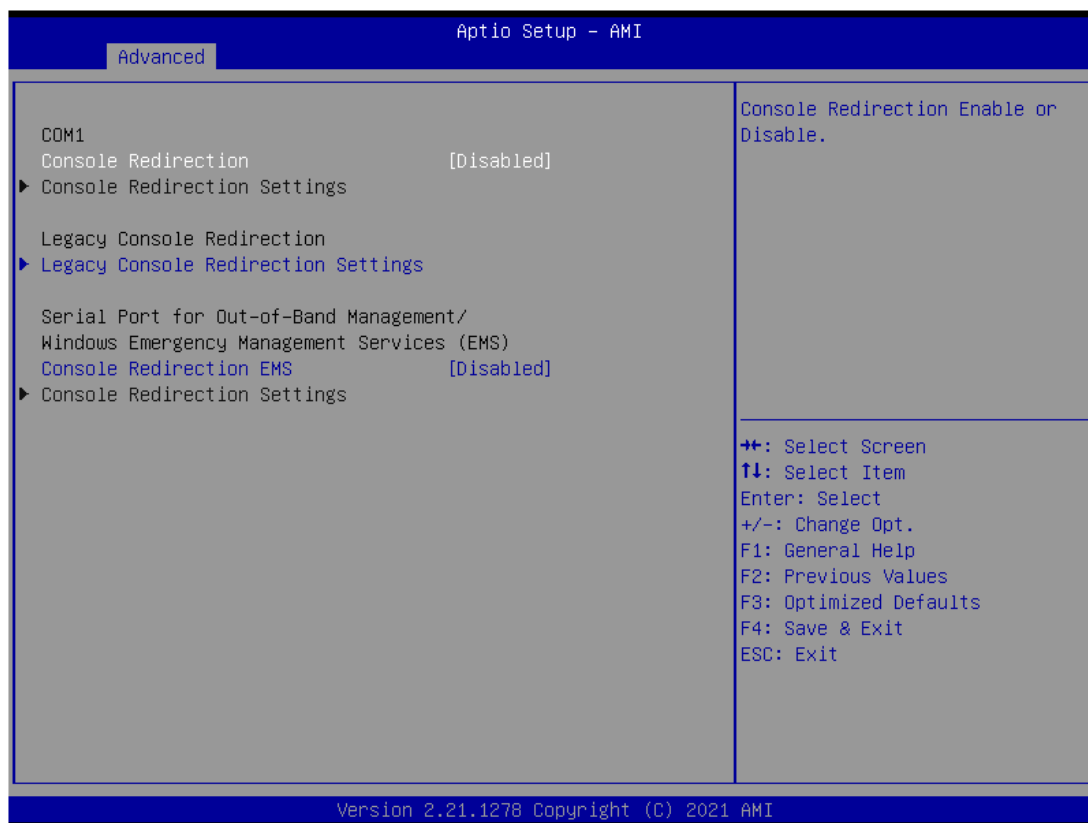

- **COM Port Type**

Use this item to set parameters of RS232/422/485.

- **Compatibility Support Module (CSM) Configuration**

This screen displays CSM information.

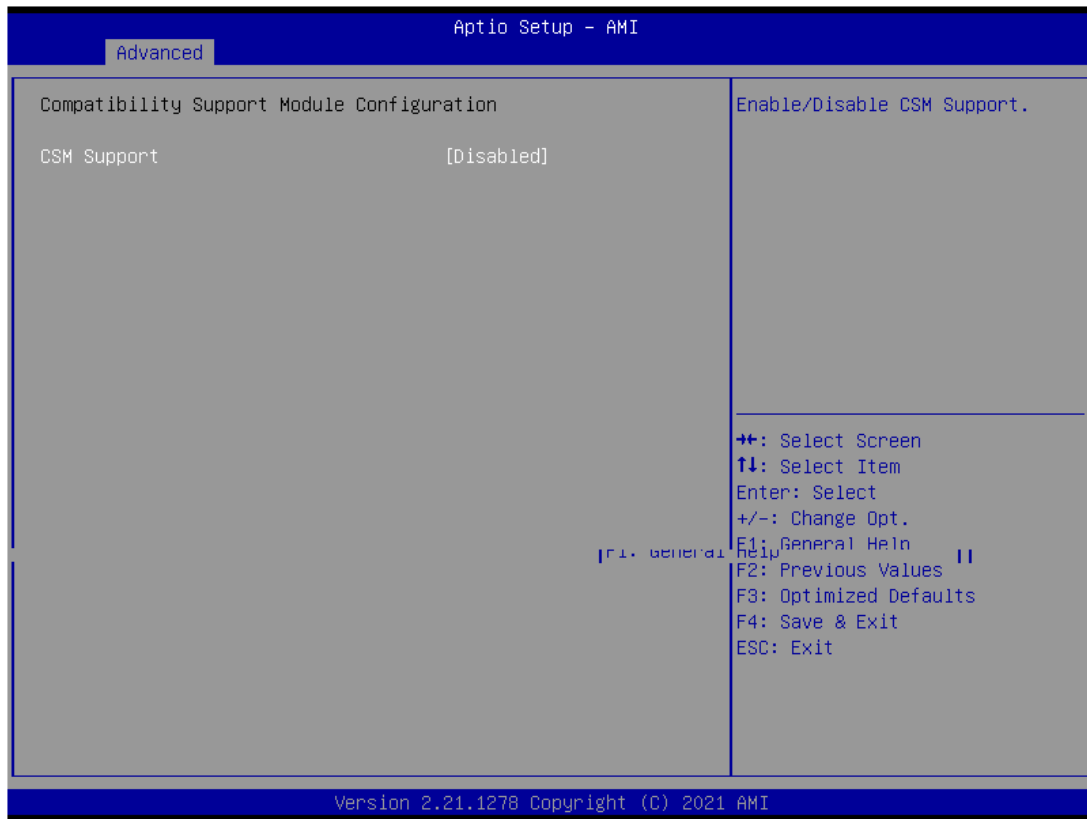

3.5 Chipset Menu

The Chipset menu allows users to change the advanced chipset settings. You can select any of the items in the left frame of the screen to go to the sub menus:

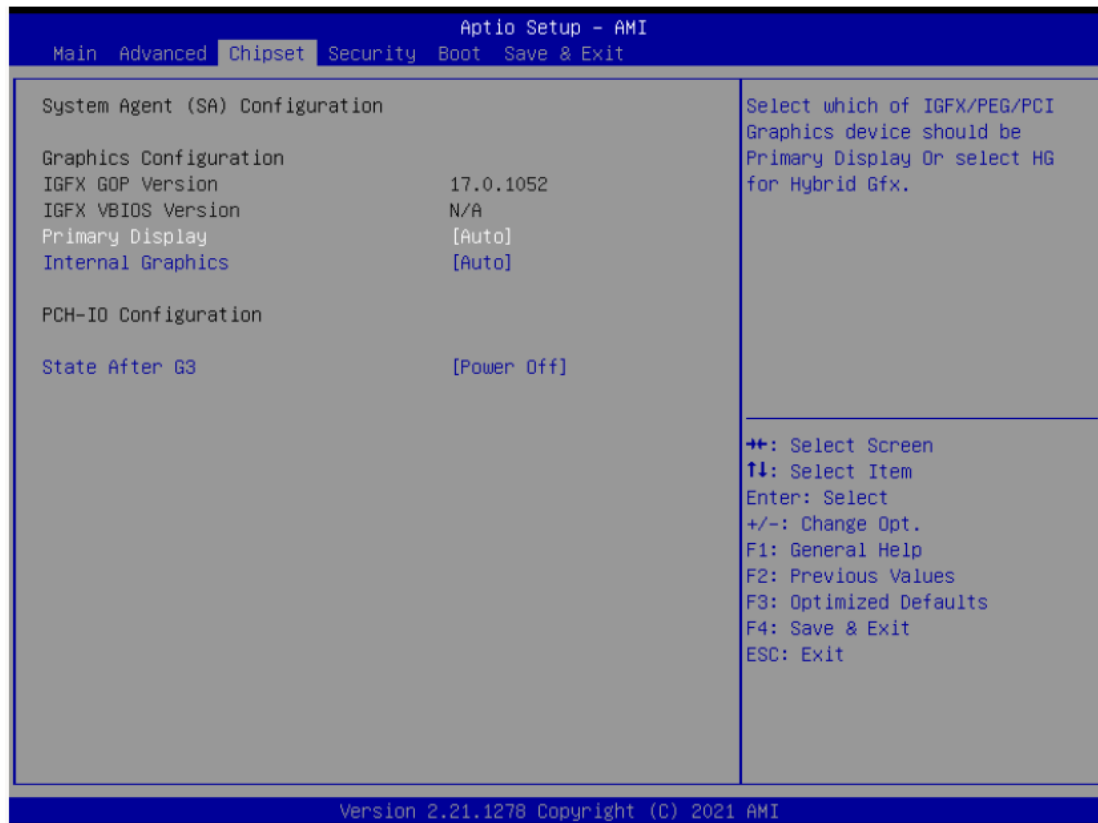

3.6 Security Menu

The Security menu allows users to change the security settings for the system.

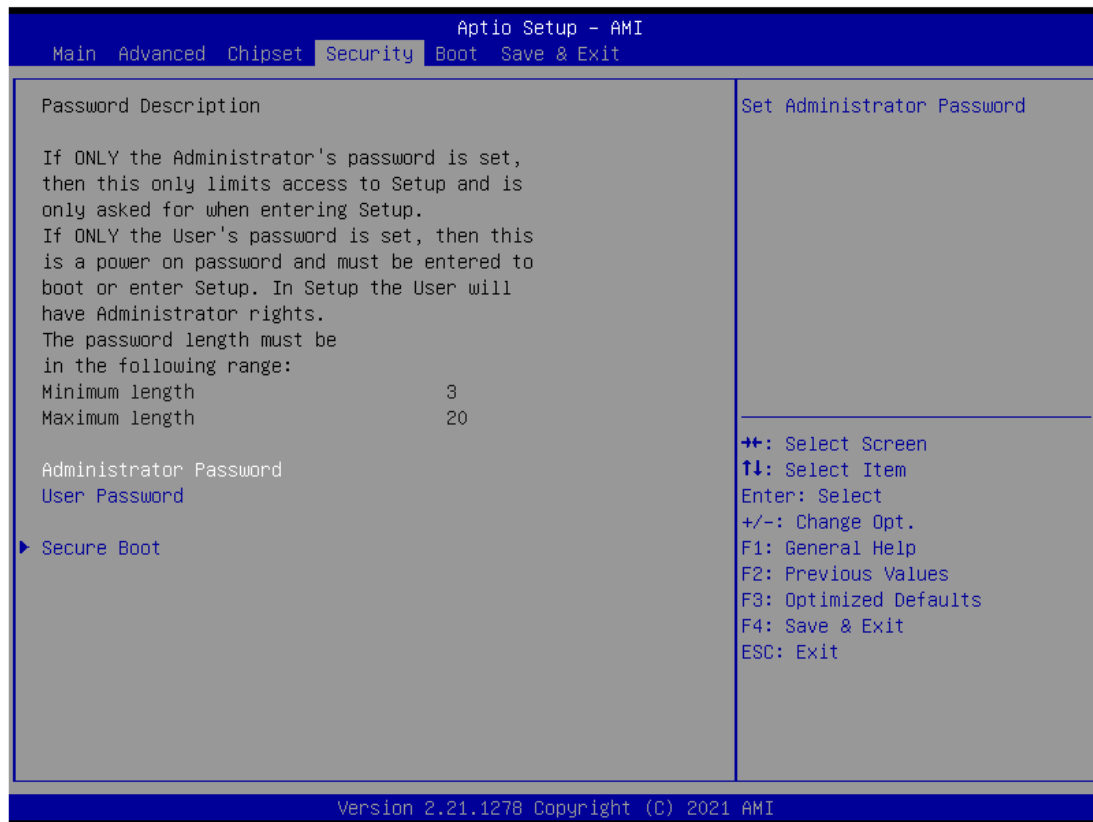

➤ Administrator Password

This item indicates whether an administrator password has been set (installed or uninstalled).

➤ User Password

This item indicates whether a user password has been set (installed or uninstalled).

● **Secure Boot**



3.7 Boot Menu

The Boot menu allows users to change boot options of the system.

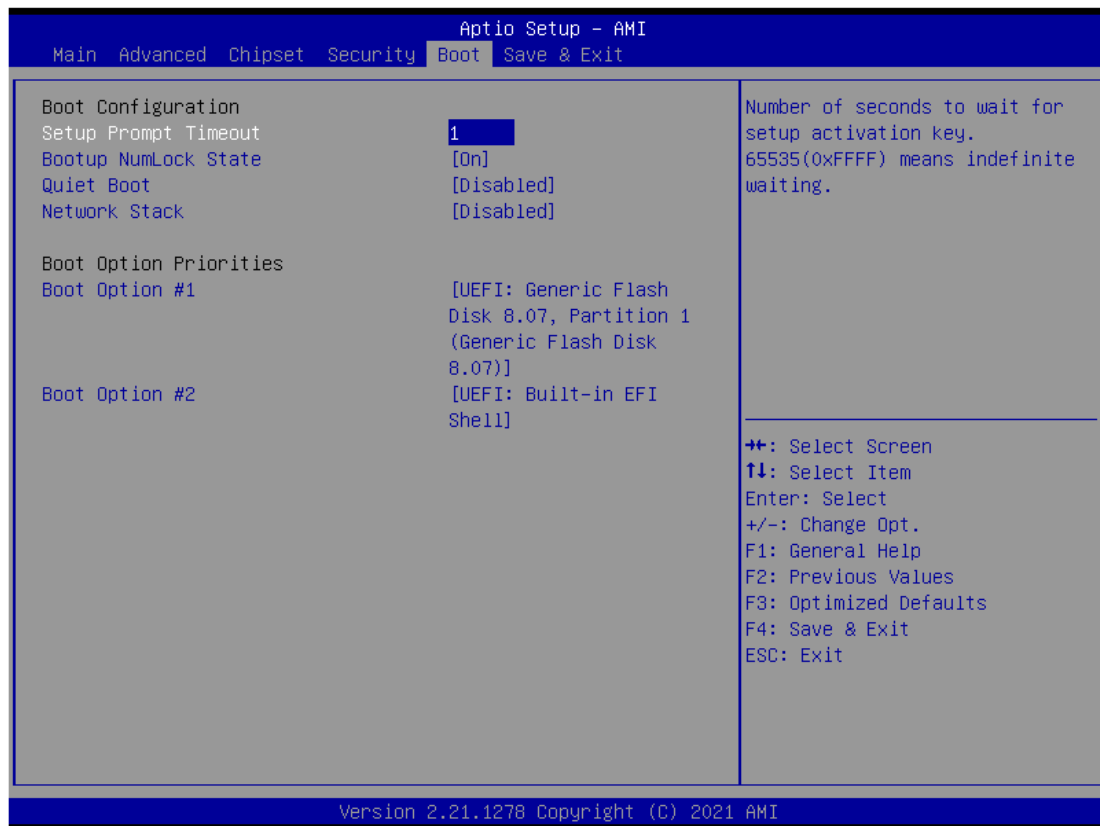

- **Setup Prompt Timeout**
Set the number of seconds to wait for setup activation key. 65535(0xFFFF) means indefinite waiting.
- **Bootup NumLock State**
Use this item to select the power-on state for the keyboard NumLock.
- **Quiet Boot**
Select to display either POST output messages or a splash screen during boot-up.
- **Boot Option Priorities**
These are settings for boot priority. Specify the boot device priority sequence from the available devices.

3.8 Save & Exit Menu

The Save & Exit menu allows users to load your system configuration with optimal or fail-safe default values.

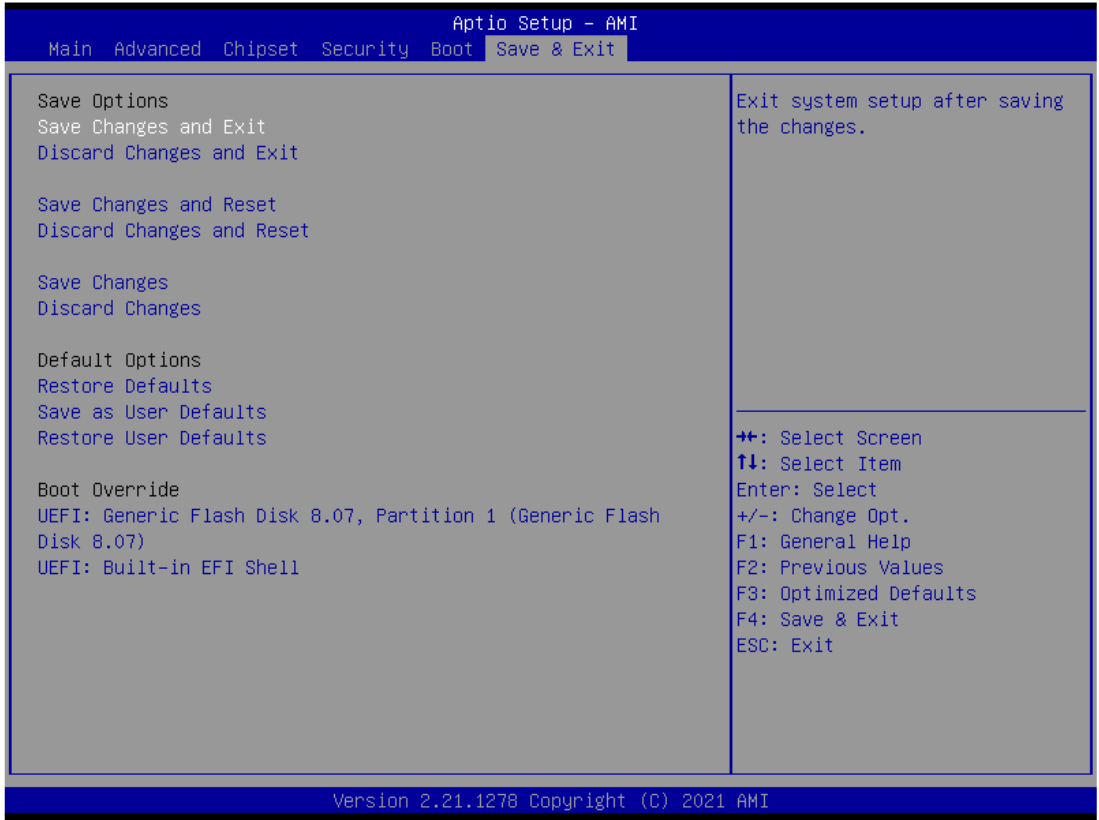

- **Save Changes and Exit**
When finishing the system configuration settings, select this option to leave Setup and return to Main Menu. Select Save Changes and Exit from the Save & Exit menu and press <Enter>. Select Yes to save changes and exit.
- **Discard Changes and Exit**
Select this option to quit Setup without making any permanent changes to the system configuration and return to Main Menu. Select Discard Changes and Exit from the Save & Exit menu and press <Enter>. Select Yes to discard changes and exit.
- **Save Changes and Reset**
When finishing the system configuration settings, select this option to leave Setup and reboot the computer so the new system configuration parameters can take effect. Select Save Changes and Reset from the Save & Exit menu and press <Enter>. Select Yes to save changes and reset.
- **Discard Changes and Reset**
Select this option to quit Setup without making any permanent changes to the system configuration and reboot the computer. Select Discard Changes and Reset from the Save & Exit menu and press <Enter>. Select Yes to discard changes and reset.

➤ **Save Changes**

When finishing the system configuration settings, select this option to save changes. Select Save Changes from the Save & Exit menu and press <Enter>. Select Yes to save changes.

➤ **Discard Changes**

Select this option to quit Setup without making any permanent changes to the system configuration. Select Discard Changes from the Save & Exit menu and press <Enter>. Select Yes to discard changes.

➤ **Save as User Defaults**

Select this option to save your current system configuration settings as User Defaults. Select Save as User Defaults from the Save & Exit menu and press <Enter>.

➤ **Restore User Defaults**

After selecting this option, all the settings will be restored to user defaults automatically. Select Restore User Defaults from the Save & Exit menu and press <Enter>.

➤ **Boot Override**

Select a drive to immediately boot that device regardless of the current boot order.

This page is intentionally left blank.

APPENDIX A WATCHDOG TIMER

A.1 About Watchdog Timer

Software stability is a major issue in most applications. Some embedded systems are not watched by an operator for 24 hours. It is usually too late to wait for someone to reboot when computer hangs. The systems need to be able to reset automatically when things go wrong. The watchdog timer gives us a solution in this regard.

The watchdog timer is a counter that triggers a system reset when it counts down to zero from a preset value. The software starts the counter with an initial value and must reset it periodically. If the counter ever reaches zero which means the software has crashed, the system will reboot.

A.2 How to Use Watchdog Timer

The I/O port base addresses of watchdog timer are 2E (hex) and 2F (hex). The 2E (hex) and 2F (hex) are address and data port respectively.

Assume that program A is put in a loop that must execute at least once every 10ms. Initialize watchdog timer with a value bigger than 10ms. If the software has no problems, watchdog timer will never expire because software will always restart the counter before it reaches zero.

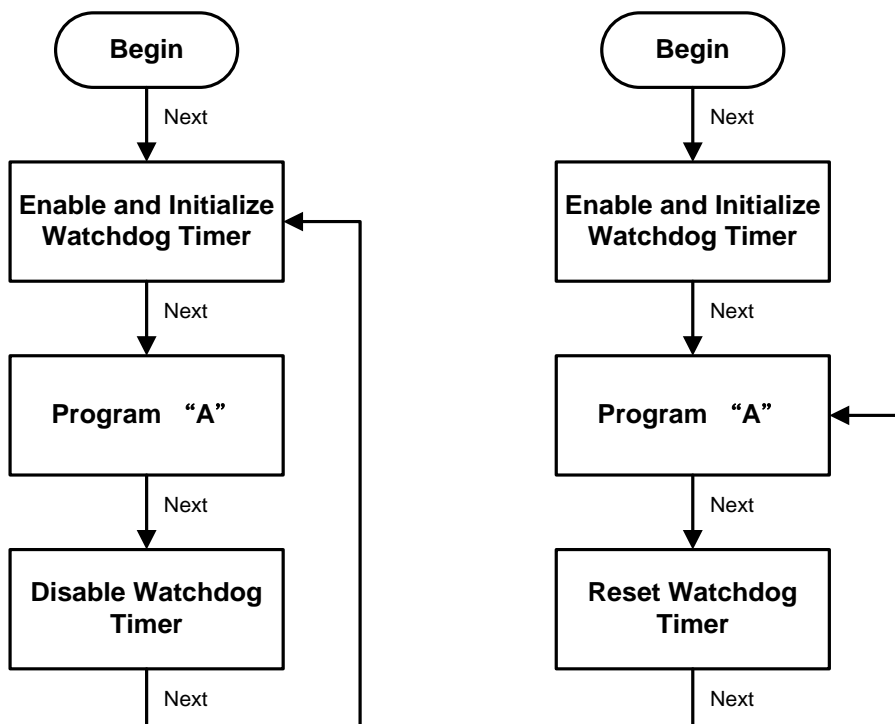

A.3 Sample Program

1. Enable configuration (following is an example to enable configuration using debug)

-O 2E 87

-O 2E 87

2. Select Logic device:

-O 2E 07

-O 2F 07

3. WDT Device Enable

-O 2E 30

-O 2F 01

4. Activate WDT:

-O 2E FA

-O 2F 01

5. Set base timer:

-O 2E F6

-O 2F 0A → Set Reset Time (Ex. A: 10 Sec)

6. Set timer unit

-O 2E F5

-O 2F 71(1: Sec ; 9: Minute)

7. Disable WDT



-O 2E 30

-O 2F 00

APPENDIX B WAKE on LAN

How to Set up Wake on LAN

Please follow the following steps to set up Wake on LAN on Windows 11.

1. Press “” w/ “S” or press “” on Windows desktop.
2. Enter “proset” in red area.

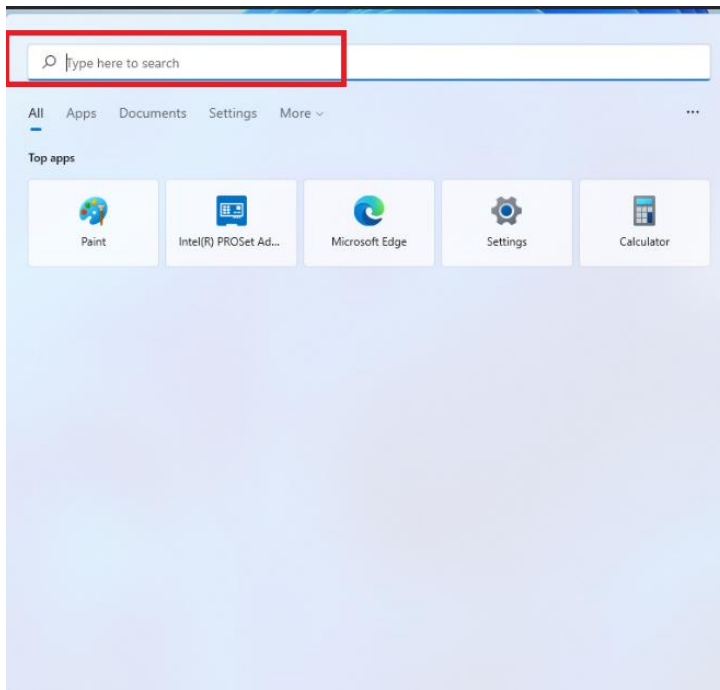

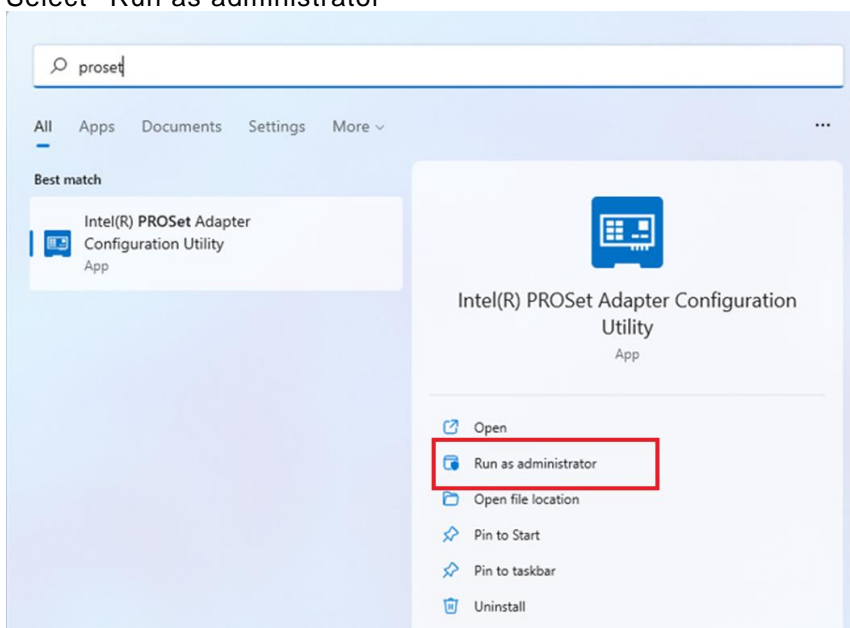

3. Select “Run as administrator”

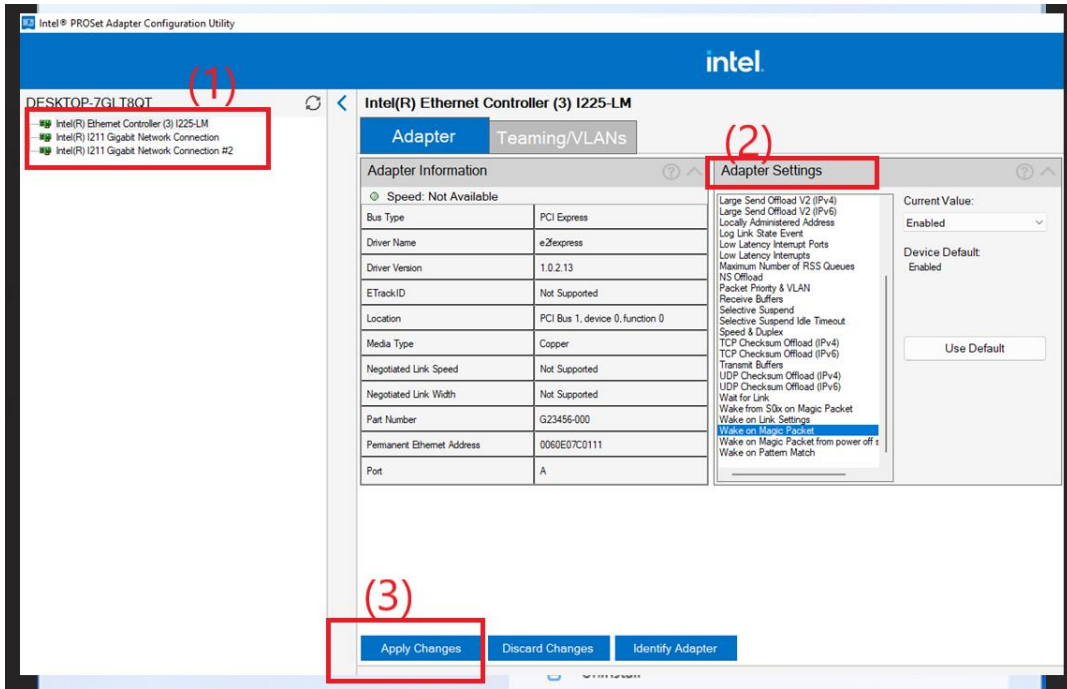

4. Select a LAN port (1) which will support “Wake on LAN”, then enable functionality you need under “Adapter Settings” (2)
5. Press “Any Changes” (3).



**Please follow step 4 and step 5 to set the other LAN ports for “Wake on LAN”

6. Press “ w/ “S” or press “” on Windows desktop.
7. Enter “control panel” in red area.

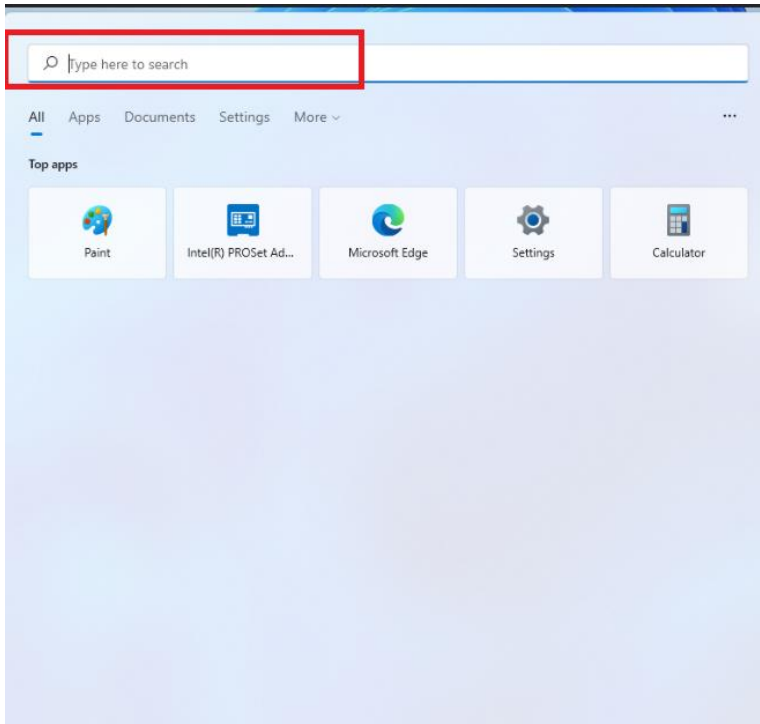

8. Select "Open".

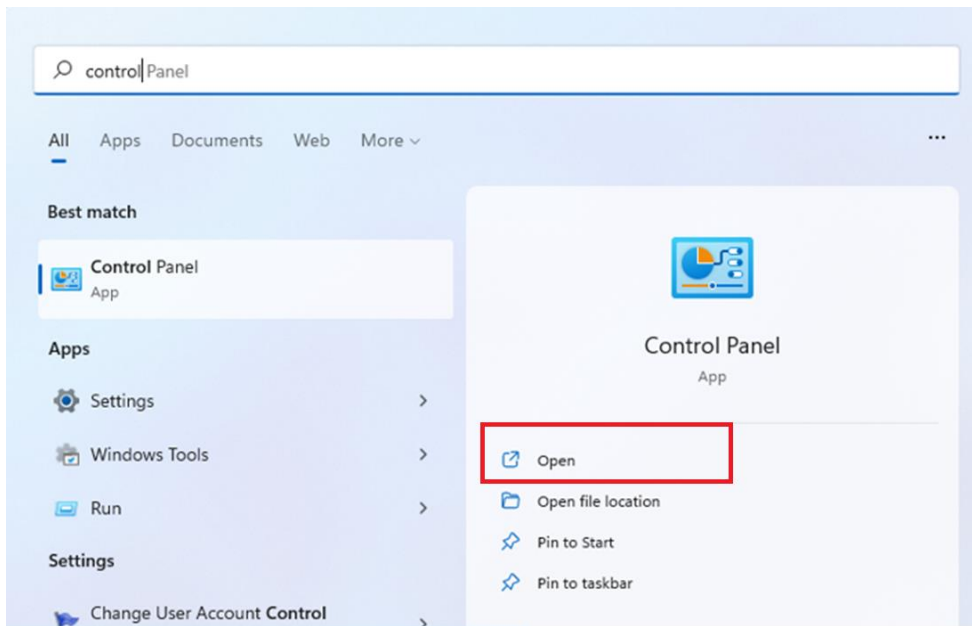

9. Press Power options → Change what the power button do

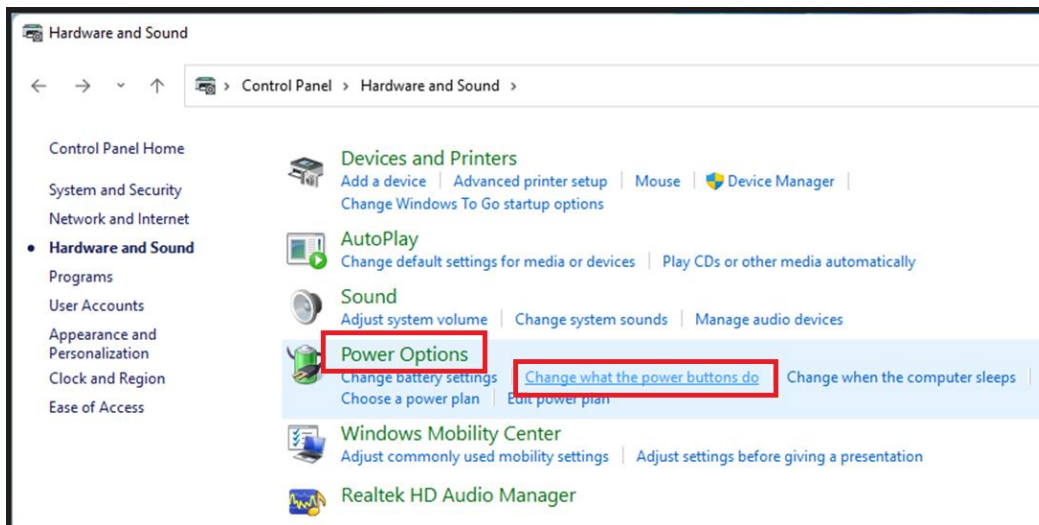

10. Remove “” from “Turn on fast startup”, the press “Save changes”.

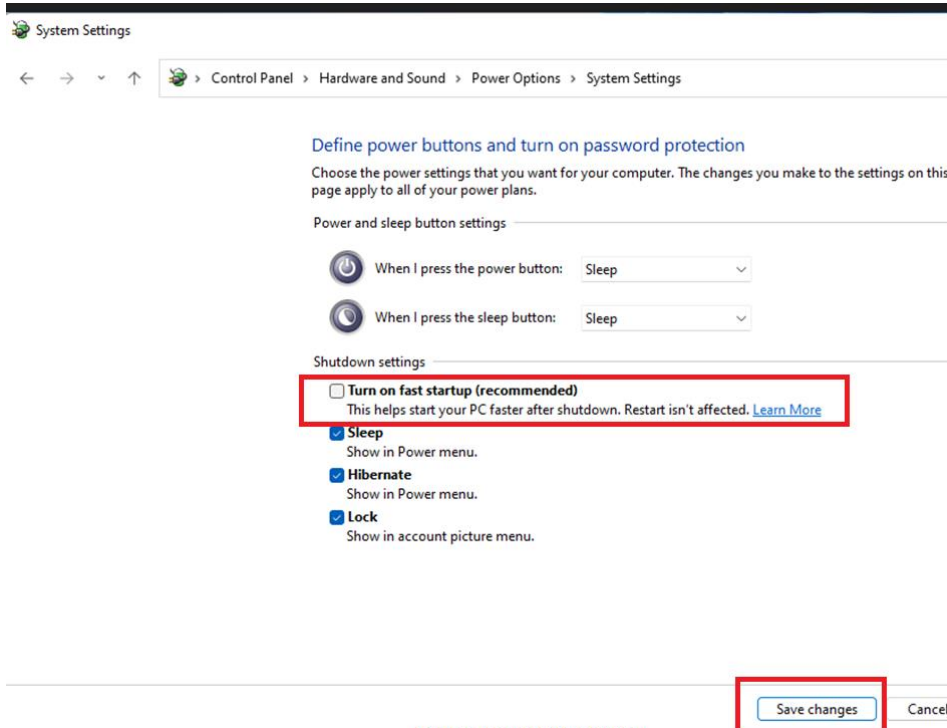

11. Reboot the system to enable the above settings. Installation is completed.