

USER'S MANUAL

GO712S-837-R-E3845- 24-110VDC

**Railway 12.1" XGA TFT LCD
PANEL PC**

User's Manual



www.axiomtek.com

Disclaimers

This manual has been carefully checked and believed to contain accurate information. Axiomtek Co., Ltd. assumes no responsibility for any infringements of patents or any third party's rights, and any liability arising from such use.

Axiomtek does not warrant or assume any legal liability or responsibility for the accuracy, completeness or usefulness of any information in this document. Axiomtek does not make any commitment to update the information in this manual.

Axiomtek reserves the right to change or revise this document and/or product at any time without notice.

No part of this document may be reproduced, stored in a retrieval system, or transmitted, in any form or by any means, electronic, mechanical, photocopying, recording, or otherwise, without the prior written permission of Axiomtek Co., Ltd.

CAUTION

If you replace wrong batteries, it causes the danger of explosion. It is recommended by the manufacturer that you follow the manufacturer's instructions to only replace the same or equivalent type of battery, and dispose of used ones.

©Copyright 2023 Axiomtek Co., Ltd.

All Rights Reserved

March. 2023, Version A2

Printed in Taiwan

Safety Precautions

Before getting started, read the following important cautions.

1. Be sure to ground yourself to prevent static charge when installing the internal components. Use a grounding wrist strap and place all electronic components in any static-shielded devices. Most electronic components are sensitive to static electrical charge.
2. Disconnect the power cords from the GOT712S Series before making any installation. Be sure both the system and the external devices are turned OFF. Sudden surge of power could ruin sensitive components. Make sure the GOT712S Series is properly grounded.
3. Do not open the system's top cover. If opening the cover for maintenance is a must, only a trained technician is allowed to do so. Integrated circuits on computer boards are sensitive to static electricity. To avoid damaging chips from electrostatic discharge, observe the following precautions:
 - Before handling a board or integrated circuit, touch an unpainted portion of the system unit chassis for a few seconds. This will help to discharge any static electricity on your body.
 - When handling boards and components, wear a wrist-grounding strap, available from most electronic component stores.

Trademarks Acknowledgments

Axiomtek is a trademark of Axiomtek Co., Ltd.

Windows[®] is a trademark of Microsoft Corporation.

IBM, PC/AT, PS/2, VGA are trademarks of International Business Machines Corporation.

Intel[®] and Pentium[®] are trademarks of Intel Corporation.

AMI is trademark of American Megatrend Inc.

Other brand names and trademarks are the properties and registered brands of their respective owners.

Table of Contents

Disclaimers.....	ii
Safety Precautions.....	iii
Section 1 Introduction.....	1
1.1 General Description	1
1.2 Specifications.....	2
1.3 Dimensions and Outlines	4
1.4 I/O Outlets	5
1.5 Packing List.....	6
Section 2 Hardware and Installation	7
2.1 Open back cover	8
2.2 Serial Ports Interface	8
2.3 USB Ports	9
2.4 Ethernet.....	9
2.5 DIO.....	10
2.5.1 Digital I/O Specification	10
2.5.2 Digital I/O Software Programming.....	11
2.5.3 Digital Input Wiring	12
2.5.4 Digital Output Wiring	13
2.6 Audio.....	13
2.7 CANBUS connector.....	14
2.8 DC Power connector.....	14
2.9 Mini card Installation.....	15
2.9.1 Wireless LAN Card Installation	15
2.9.2 mSATA Card Installation.....	16
2.10 LED indicators.....	17
2.11 Auto-dimming.....	17
Section 3 AMI BIOS Setup Utility	19
3.1 Starting.....	19
3.2 Menu Bar.....	20
3.3 Navigation Keys	20
3.4 Main Menu.....	21
3.5 Advanced Menu.....	22

3.6	Chipset Menu.....	29
3.7	Security Menu.....	31
3.8	Boot Menu.....	32
3.9	Exit Menu	33

This page is intentionally left blank.

Section 1

Introduction

This chapter contains general information and detailed specifications of the GOT712S-837. Chapter 1 includes the following sections:



- General Description
- Specification
- Dimensions
- I/O Outlets
- Package List

1.1 General Description

GOT712S-837 is used to keep the train driver informed about the status of the train's functions. Its design allows it to be deployed in environment with an extended temperature (-40°C ~ 70°C) and it also complies with the EMC, shock and vibration test requirements of European standard EN 50155 for railway applications. GOT712S-837 is equipped with 12.1" TFT ruggedized touch panel computer and all lockable connectors are perfect choice for Human Machine Interface (HMI) in railway environments. The 12.1" railway touch panel PC includes a comprehensive feature set with one CAN Bus, DIO, audio, two Ethernet ports, USB ports and RS-232/422/485.

Railway application-EN50155 certificated

Railway power module design support 10ms interruption, EMI EN 55022 CLASS A filter, over/short current protection for its railway application.

Sunlight readable design

Its sunlight readable technology with LED tech high brightness 800 nits color display allows the screen legible even strong sunlight.

Powerful computing: Intel® Atom Bay Trail processors

GOT712S-837 features Intel® Atom processors that offers reliable and stable performance and rugged environment.

1.2 Specifications

Main CPU Board

- **CPU**
 - Intel® Atom™ E3845 1.91GHz processor onboard
- **System Memory**
 - DDR3L 4 GB onboard
- **BIOS**
 - America Megatrends Inc BIOS

I/O System

- **Standard I/O**
 - 2 x RS-232/422/485 with isolated 1.5KV (M12, A-coded)
 - 2 x Gigabit LAN with isolated 1.5KV (M12, X-coded)
 - 2 x USB 2.0 (M12, A-coded)
 - 1 x DIO (6 input/2 output) with isolated 1.5KV (Phoenix type)
 - 1 x CAN bus with isolated 1.5KV (D-sub)
- **Audio**
 - 1 x Audio: Line-in, & Mic-in, Speaker-out or Line-out (D-sub)
- **Expansion**
 - 2 x PCIe Mini Card slots
- **Storage**
 - 16 GB flash onboard
 - 1 x mSATA
- **Power connector**
 - 1 x DC for power input with isolated 1.5KV (M12, A-coded)

System Specification

- **12.1" XGA(1024 X 768)LCD**
- **5 wired resistive Touch or glass**
- **IP65/NEMA4 aluminum front bezel**
- **Net Weight**
 - 3 Kgs (6.61 lb)
- **Dimension (Main Body Size)**
 - 330 x 61.5 x 245 mm
- **Operation Temperature**
 - -40°C to 70°C
- **Relative Humidity**
 - 10% to 95% @ 40°C, Non-Condensing
- **Power Input**
 - 24V to 110VDC, 20ms interruption hold up (EN 50155 Class S3)



NOTE All specifications and images are subject to change without notice.

1.3 Dimensions and Outlines

The following diagrams show the dimensions and outlines of GOT712S-837.

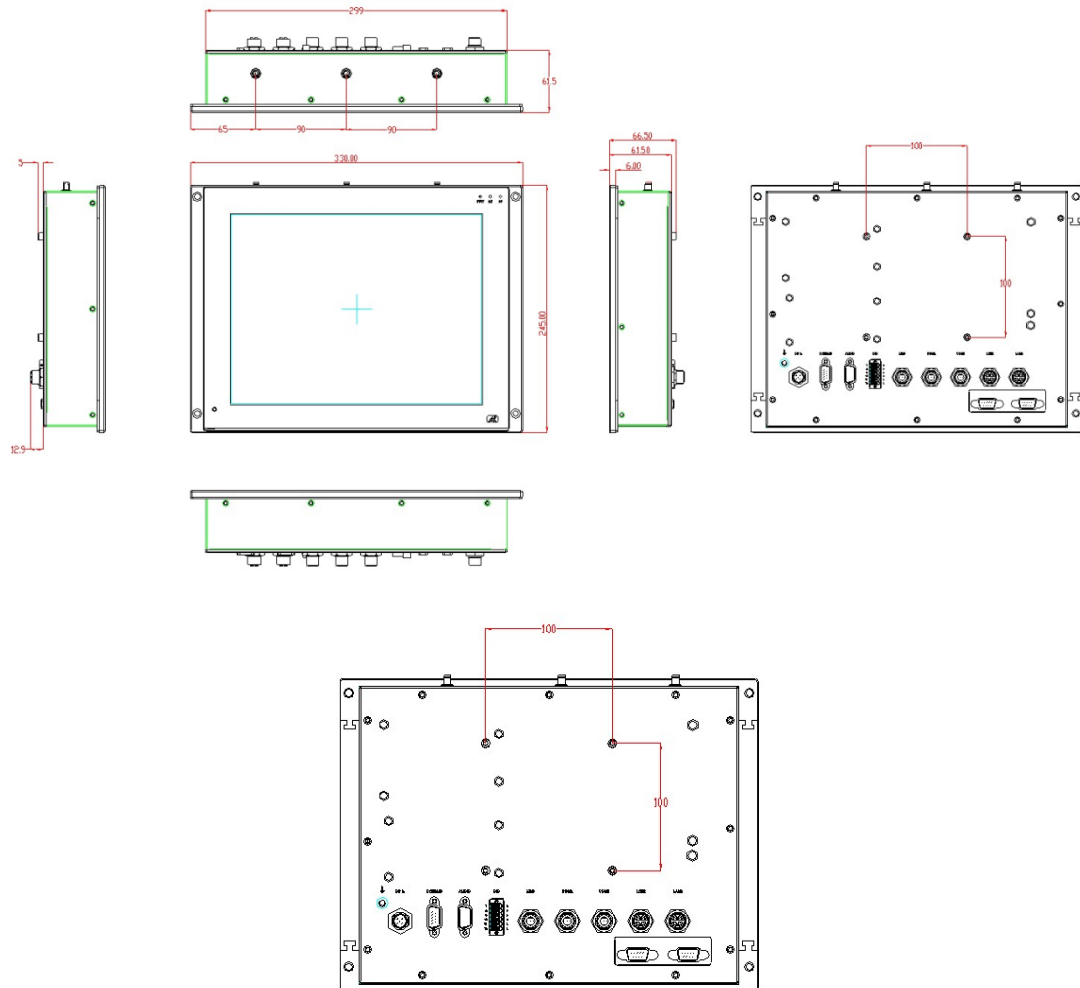

1.4 I/O Outlets

Please refer to the following illustration for I/O locations of the GOT712S-837.

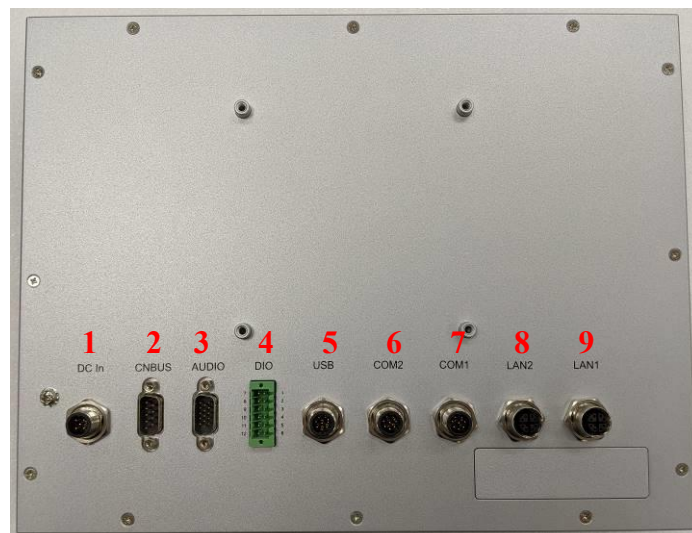

No	Function
1	DC for power input with isolated 1.5KV
2	CAN Bus with isolated 1.5KV
3	Audio (Line out, Line in, speaker out)
4	DIO (6 input/2 output with isolated 1.5KV)
5	USB 2.0 x 2(M12, A-coded)
6	COM 2 (RS-232/422/485 with isolated 1.5KV)
7	COM 1 (RS-232/422/485 with isolated 1.5KV)
8	LAN 2 (Gigabit LAN with isolated 1.5KV)
9	LAN 1 (Gigabit LAN with isolated 1.5KV)

1.5 Packing List

When you receive the GOT712S-837, the bundled package should contain the following items:

- **GOT712S-837 unit x 1**
- **Phoenix Connector x 1**

If you can not find the package or any items are missing, please contact Axiomtek distributors immediately.

Section 2

Hardware and Installation

The GOT712S-837 provides rich I/O ports and flexible expansions for you to meet different demand. The chapter will show you how to install the hardware. It includes:

- Open back cover
- Serial Ports
- USB Ports
- Ethernet
- DIO
- Audio
- CANBus
- DC Power
- Mini card
- System jumper setting
- System Panel Header
- Hard keys on front bezel (optional)
- LED Indicators
- Auto-dimming

2.1 Open back cover

This section tells users how to open back cover. Please follow the steps below.

Step 1 Unscrew 12 screws on the back cover. Please refer the photo below.



2.2 Serial Ports Interface

This system supports RS-232/422/485 isolated 1.5KV on COM1~COM2 ports. The pin assignments are listed in table below. If you need to adjust these COM ports to work as RS-232/422/485, please refer to BIOS setting in section 3.5.

Pin	RS-232	RS-422	RS-485
1	NDCD	TX-	Data-
2	NRX	TX+	Data+
3	NTX	RX+	No use
4	NDTR	RX-	No use
5	NDSR	No use	No use
6	NRTS	No use	No use
7	NCTS	No use	No use
8	ISO1_GND	ISO1_GND	ISO1_GND

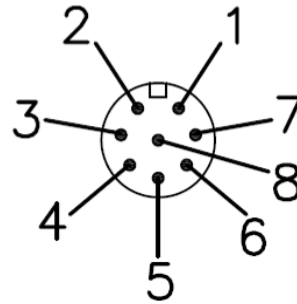

2.3 USB Ports

This system supports two USB ports. The pin assignments are listed in table below.

Pin	Definition
1	USB1_PWR
2	USB_DN1_C
3	USB_DP1_C
4	GND
5	USB2_PWR
6	USB_DN2_C
7	USB_DP2_C
8	GND

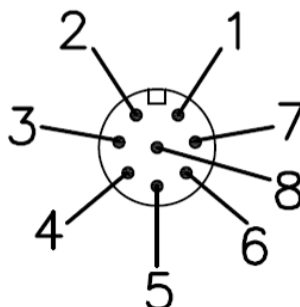

2.4 Ethernet

The GOT712S-837 is equipped with two high performance plug and play Ethernet interfaces with X-coded which are fully compliant with the IEEE 802.3 standard. Connection can be established by plugging one end of the Ethernet cable into this RJ-45 connector and the other end to a 1000/100/10-Base-T hub with isolated 1.5KV.

CN4_LAN1		CN4_LAN2	
Pin	Definition	Pin	Definition
1	LAN1_MDOP0	1	LAN2_MDOP0
2	LAN1_MDON0	2	LAN2_MDON0
3	LAN1_MDOP1	3	LAN2_MDOP1
4	LAN1_MDON1	4	LAN2_MDON1
5	LAN1_MDOP3	5	LAN2_MDOP3
6	LAN1_MDON3	6	LAN2_MDON3
7	LAN1_MDON2	7	LAN2_MDON2
8	LAN1_MDOP2	8	LAN2_MDOP2
9	GND_LAN	9	GND_LAN



2.5 DIO

2.5.1 Digital I/O Specification

This system supports one DIO (6 input and 2 output) with isolated 1.5KV. The pin assignments are listed in table below.

Digital Input:

Input channels: 6, sink/source type

Input voltage: 0 to 30VDC at 25Hz

Input level for dry contacts:

Logic level 0: close to ground

Logic level 1: open

Input level for wet contacts:

Logic level 1: +/-3VDC max.

Logic level 0: +/- 10VDC min. to +/-30VDC max. (source to digital input)

Digital output:

output channels: 2, sink type

output current: 200mA max. per channel

on-state voltage: 12~ 24VDC nominal

max. voltage on COM+: 30VDC

Pin	Definition
1	Common PWR+
2	DI4
3	DI5
4	DO0
5	DO1
6	Common PWR-
7	EXT_POWER
8	DI0
9	DI1
10	DI2
11	DI3
12	Isolation GND

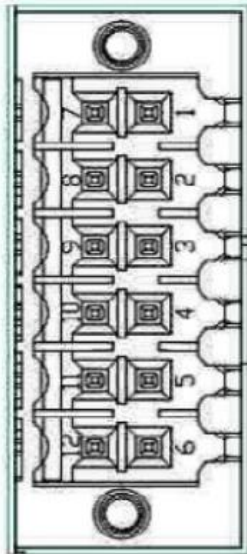

2.5.2 Digital I/O Software Programming

- I2C to GPIO PCA9554PW GPIO Group0[5:0] is Input, Group0[7:6] is Output.
- I2C address: 0b0100100x.
- Registers:

Register 0: Input Group0 register.

Table 4. Register 0 - Input Port register bit description

Bit	Symbol	Access	Value	Description
7	I7	read only	X	determined by externally applied logic level
6	I6	read only	X	
5	I5	read only	X	
4	I4	read only	X	
3	I3	read only	X	
2	I2	read only	X	
1	I1	read only	X	
0	I0	read only	X	

Register 2: Output Group0 register.

Table 5. Register 1 - Output Port register bit description

Legend: * default value.

Bit	Symbol	Access	Value	Description
7	O7	R	1*	reflects outgoing logic levels of pins defined as outputs by Register 3
6	O6	R	1*	
5	O5	R	1*	
4	O4	R	1*	
3	O3	R	1*	
2	O2	R	1*	
1	O1	R	1*	
0	O0	R	1*	

2.5.3 Digital Input Wiring

DRY contact

Logic level 0: close to ground

Logic level 1: open

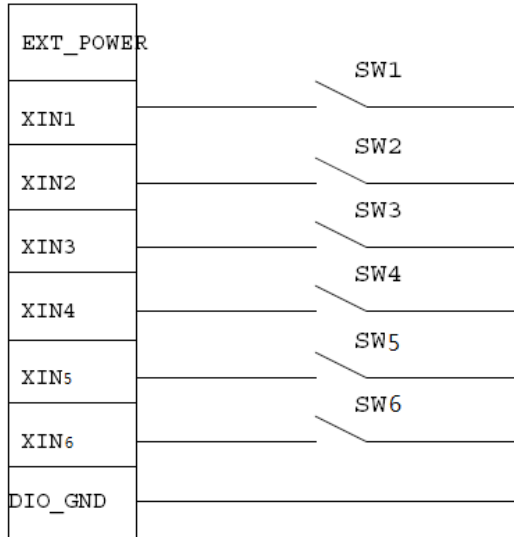

WET contact

Logic level 1: +/-3VDC max.

Logic level 0: +/- 10VDC min. to +/-30VDC max

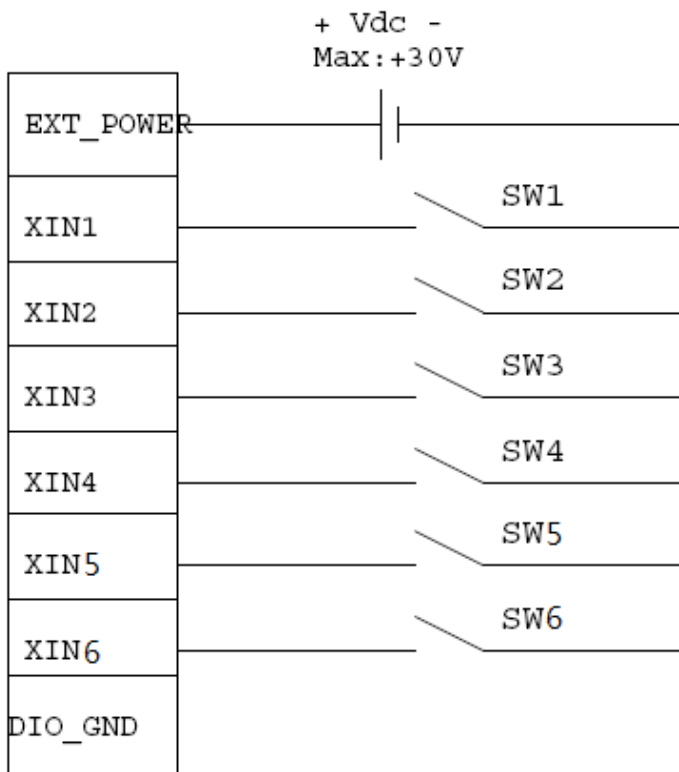

2.5.4 Digital Output Wiring

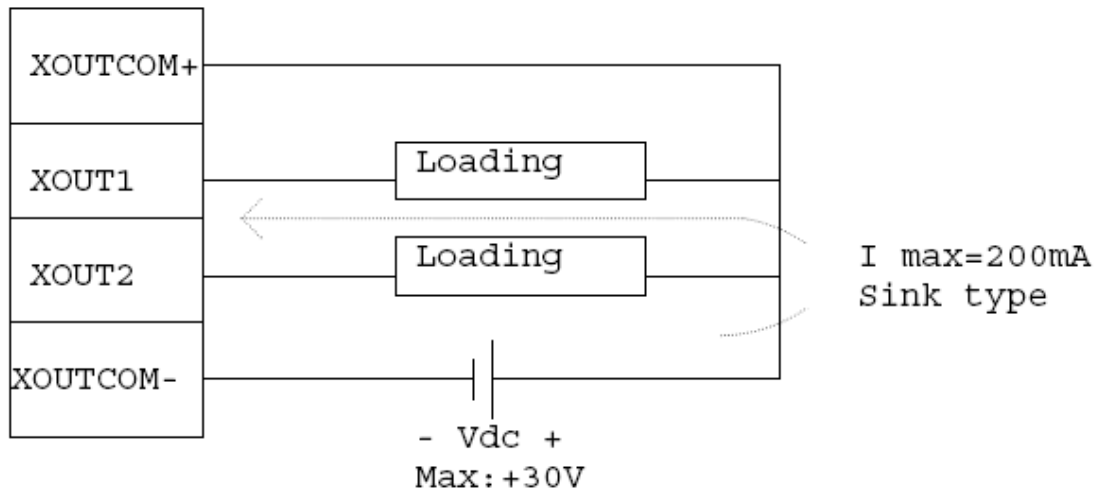

2.6 Audio

This system supports one Audio (Line out, Line in, speaker out) with isolated 1.5KV. The pin assignments are listed in table below.

Pin	Definition
1	SPEK_OUTA+
2	SPEK_OUTA-
3	AUDIO_GND
4	AUDIO_OUT_L
5	AUDIO_OUT_R
6	NA
7	FRONT-JD
8	AUDIO_GND
9	AUDIO_LIN_IN_L
10	AUDIO_LIN_IN_R
11	BUZZER+
12	BUZZER-
13	MIC-JD
14	MIC_IN
15	AUDIO_GND

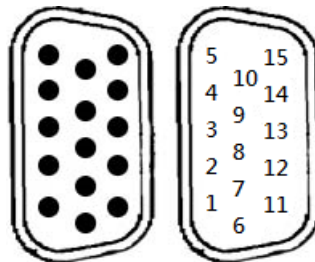

2.7 CANBUS connector

This system supports one CANBus with isolated 1.5KV. The pin assignments are listed in table below.

Pin	Definition
1	NA
2	CAN_LO
3	ISO3_GND
4	NA
5	NA
6	ISO3_GND
7	CAN_HO
8	NA
9	NA

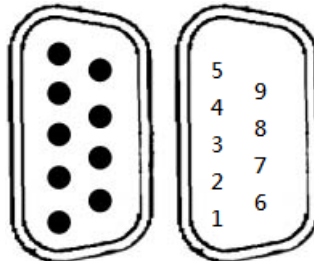

2.8 DC Power connector

The system supports one DC for power input with isolated 1.5KV. The pin assignments are listed in table below.

Pin	Definition
1	PWR_V+
2	PWR_V+
3	PWR_V-
4	PWR_V-
5	ACC



Note 1 : If the testing environment is not able to provide ACC, please short the V+ & ACC signal pin of the cable.

2.9 Mini card Installation

2.9.1 Wireless LAN Card Installation

The GOT712S-837 provides two Mini card slots for user to install wireless LAN cards. You can choose either slot 1 or slot 2 to install the wireless LAN card and refer to the following.

Step 1 Open the back cover and find out the mini-card slot on main board.

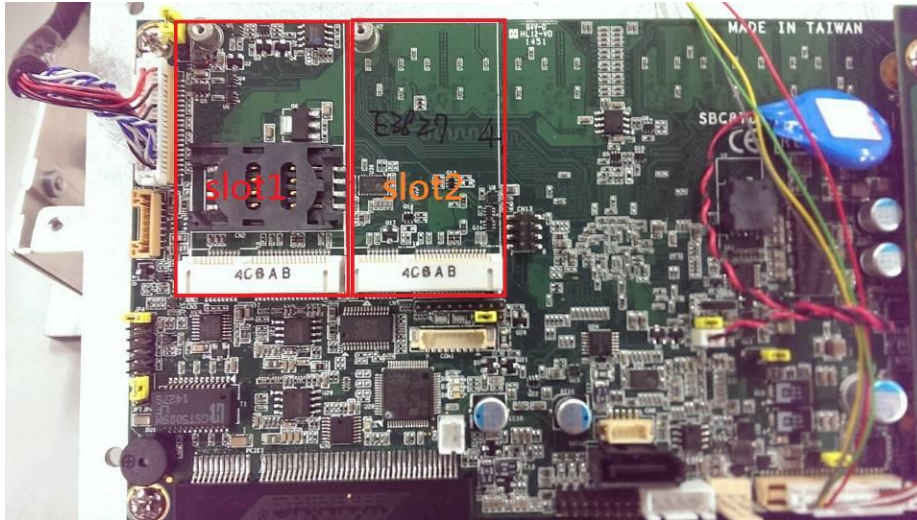

Step 2 Insert the wireless LAN card to the slot. Screw it firmly on the slot.

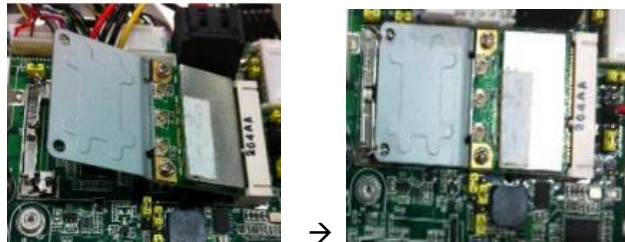

Step 3 There are two connectors on wireless LAN card. One is MAIN, and the other is auxiliary. Connect antenna cable to MAIN connector on wireless LAN card.

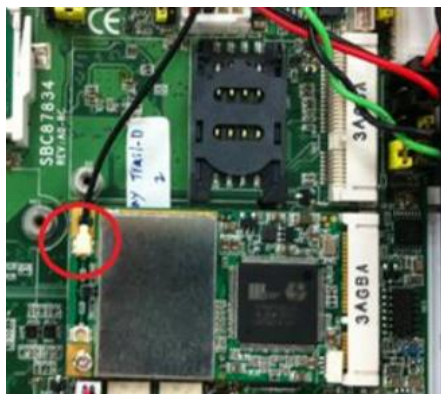

2.9.2 mSATA Card Installation

The GOT712S-837 provides one Mini card slot for user to install mSATA. Please choose the slot 2 when installing the mSATA card and refer to the following instructions and illustration:

Step 1 Open the back cover and find out the mini-card slot on main board.

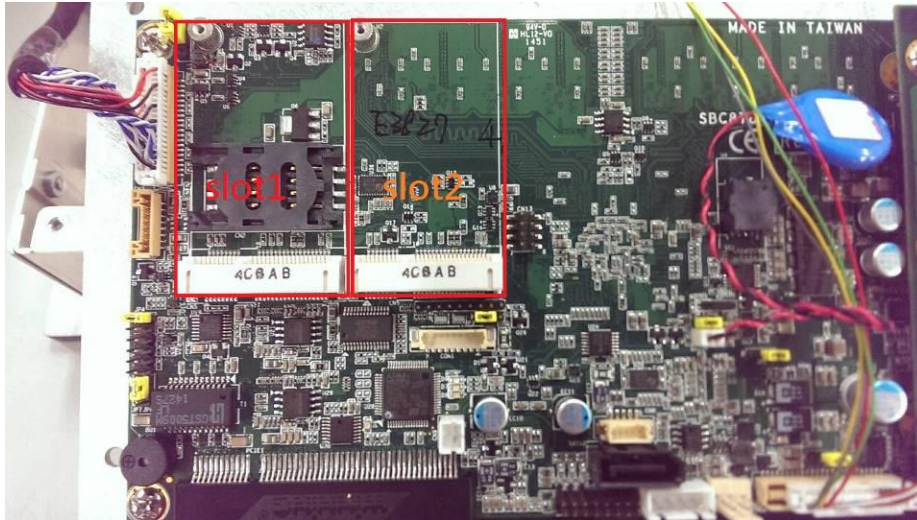

Step 2 Insert the mSATA card to the slot 2. Screw it firmly on the slot.

2.10 LED indicators

LED lights make sure that whether the MCU is working properly and facilitating to debug in the phrase of research and development. It is not necessarily the actual system mounting LED lights

The following table summarizes the LED indication of the device:

Status	PWR (Green)	S2 (Yellow)	S1 (Red)
Power up	ON	ON	ON
Device working properly	ON	OFF	OFF
Over-temperature warning	ON	Blink	OFF
Key pressed	Flash	X	X

2.11 Auto-dimming

Because the human eye perceiving brightness is nonlinear, PWM duty must be set percentage at each stage of opening and closing

LCD Backlight:

- Level 10 = 100%
- Level 9 = 91%
- Level 8 = 82%
- Level 7 = 73%
- Level 6 = 64%
- Level 5 = 55%
- Level 4 = 46%
- Level 3 = 37%
- Level 2 = 28%
- Level 1 = 19%
- Level 0 = 10%

Auto dimming level

Surrounding environment	Light Sensor value	LCD dimming level
Tunnel (0~26 Lux)	0~50	23%~37%
Indoor (200~300 Lux)	200~300	72%~80%
Outdoor cloudy (1000 Lux)	1000	88%~100%
Outdoor sunny (2000 Lux up)	1200 up	100%

This page is intentionally left blank.

Section 3

AMI BIOS Setup Utility

The AMI UEFI BIOS provides users with a built-in setup program to modify basic system configuration. All configured parameters are stored in a flash chip to save the setup information whenever the power is turned off. This chapter provides users with detailed description about how to set up basic system configuration through the AMI BIOS setup utility.

3.1 Starting

To enter the setup screens, follow the steps below:

1. Turn on the computer and press <F2> or during the Power On Self Test (POST) to enter BIOS setup, otherwise, POST will continue with its test routines.
2. After you press the key, the main BIOS setup menu displays. You can access the other setup screens from the main BIOS setup menu, such as the Advanced and Chipset menus.



NOTE *If your computer cannot boot after making and saving system changes with BIOS setup, you can restore BIOS optimal defaults by setting CLRCMOS1 (see section 2.3.1).*

If you wish to enter BIOS setup after POST, restart the system by pressing <Ctrl>+<Alt>+<Delete>, or by pressing the reset button on the system chassis. You may also restart by turning the system off and then back on.

It is strongly recommended that you should avoid changing the chipset's defaults. Both AMI and your system manufacturer have carefully set up these defaults that provide the best performance and reliability.



NOTE *Because the BIOS setup software is constantly being updated, the following setup screens and descriptions are for reference purpose only, and they may not exactly match what you see on your screen.*

3.2 Menu Bar

The top of the screen has a menu bar with the following selections:

Menu Bar	Description
Main	To set up the system time/date information.
Advanced	To set up the advanced BIOS features.
H/W Monitor	To display current hardware status.
Boot	To set up the default system device to locate and load the operating system.
Security	To set up the security features.
Exit	To exit the current screen or the BIOS setup utility.

Use <<<> key or <>>> key to choose among the selections on the menu bar, and then press <Enter> to get into the sub screen. You can also use the mouse to click your required item.

3.3 Navigation Keys

The BIOS setup/utility uses a key-based navigation system called hot keys. Most of the BIOS setup utility hot keys can be used at any time during the setup navigation process. These keys include <F1>, <F7>, <Enter>, <ESC>, <Arrow> keys, and so on.



NOTE Some of the navigation keys differ from one screen to another.

Please check the following table for the function description of each navigation key.

Hot Keys	Description
→← Left/Right	The Left and Right <Arrow> keys allow you to select a setup screen.
↑↓ Up/Down	The Up and Down <Arrow> keys allow you to select a setup screen or sub-screen.
+– Plus/Minus	The Plus and Minus <Arrow> keys allow you to change the field value of a particular setup item.
Enter	The <Enter> key allows you to display or change the setup option listed for a particular setup item. The <Enter> key can also allow you to display the setup sub- screens.
F1	The <F1> key allows you to display the General Help screen.
F7	Discard changes.
F9	The <F9> key allows you to load optimal default values for all the settings.
F10	The <F10> key allows you to save any changes you have made and exit Setup. Press the <F10> key to save your changes.
Esc	The <Esc> key allows you to discard any changes you have made and exit the Setup. Press the <Esc> key to exit the setup without saving your changes.

3.4 Main Menu

When you first enter the setup utility, you will enter the Main setup screen. You can always return to the Main setup screen by selecting the Main tab. System Time/Date can be set up as described below. The Main BIOS setup screen is shown below.



BIOS Information

Display the auto-detected BIOS information.

System Date/Time

Use this option to change the system time and date. Highlight System Time or System Date using the <Arrow> keys. Enter new values through the keyboard. Press the <Tab> key or the <Arrow> keys to move between fields. The date must be entered in MM/DD/YY format. The time is entered in HH:MM:SS format.

3.5 Advanced Menu

The Advanced menu also allows users to set configuration of the CPU and other system devices. You can select any of the items in the left frame of the screen to go to the sub menus:

- NCT6106D Super IO Configuration
- NCT6106D H/W Monitor
- CPU Configuration
- IDE Configuration
- Miscellaneous Configuration
- CSM Configuration
- USB Configuration

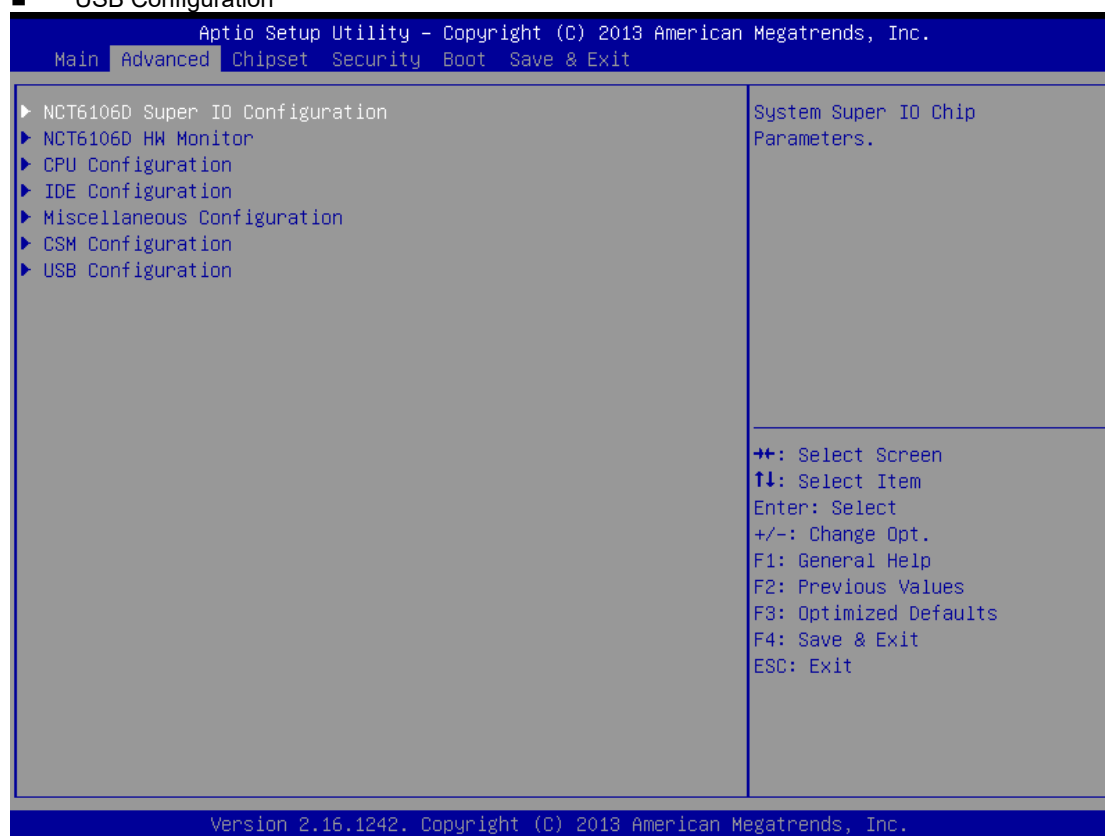

For items marked with "▶", please press <Enter> for more options.



NOTE Setting wrong values in this section may cause the system to malfunction.

- **NCT6106D Super IO Configuration**

Use this screen to select options for the Super IO Configuration, and change the value of the selected option

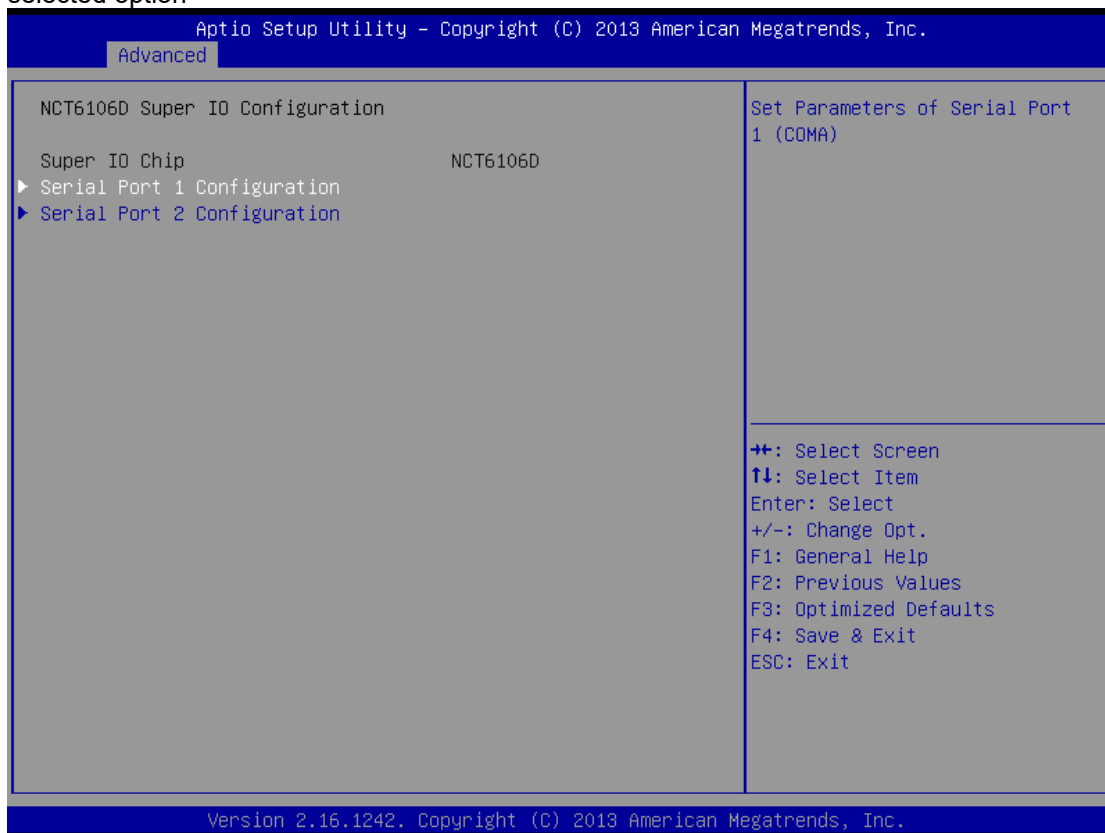

Serial Port 1-2 configuration

1. Serial port:

This option used to enable or disable the serial port.

2. Device Setting:

This item specifies the base I/O port address and Interrupt Request address of serial port.

The port 1 Optimal setting is *3F8/IRQ4*.

The port 2 Optimal setting is *2F8/IRQ3*

3. Serial type:

This option used to select RS232/422/485 function.



- **NCT6106D H/W Monitor**

This screen shows the Hardware Health Configuration.

Aptio Setup Utility - Copyright (C) 2013 American Megatrends, Inc.

Advanced

Pc Health Status	
System temperature	: +39.0 C
CPU temperature	: +37.0 C
VCORE	: +0.888 V
MEMORY	: +1.332 V
+12V	: +11.968 V
+5V	: +5.096 V
+3.3V	: +3.264 V

++: Select Screen
 ↑↓: Select Item
 Enter: Select
 +/-: Change Opt.
 F1: General Help
 F2: Previous Values
 F3: Optimized Defaults
 F4: Save & Exit
 ESC: Exit

Version 2.16.1242. Copyright (C) 2013 American Megatrends, Inc.

- **CPU Configuration**

This screen shows the CPU Configuration and intel virtualization technology enable/disable selected

Aptio Setup Utility - Copyright (C) 2013 American Megatrends, Inc.

Advanced

CPU Configuration		Socket specific CPU Information
▶ Socket 0 CPU Information		
CPU Speed	1918 MHz	
64-bit	Supported	

++: Select Screen
 ↑↓: Select Item
 Enter: Select
 +/-: Change Opt.
 F1: General Help
 F2: Previous Values
 F3: Optimized Defaults
 F4: Save & Exit
 ESC: Exit

Version 2.16.1242. Copyright (C) 2013 American Megatrends, Inc.

● **IDE Configuration**

You can use this screen to select options for the SATA Configuration, and change the value of the selected option.

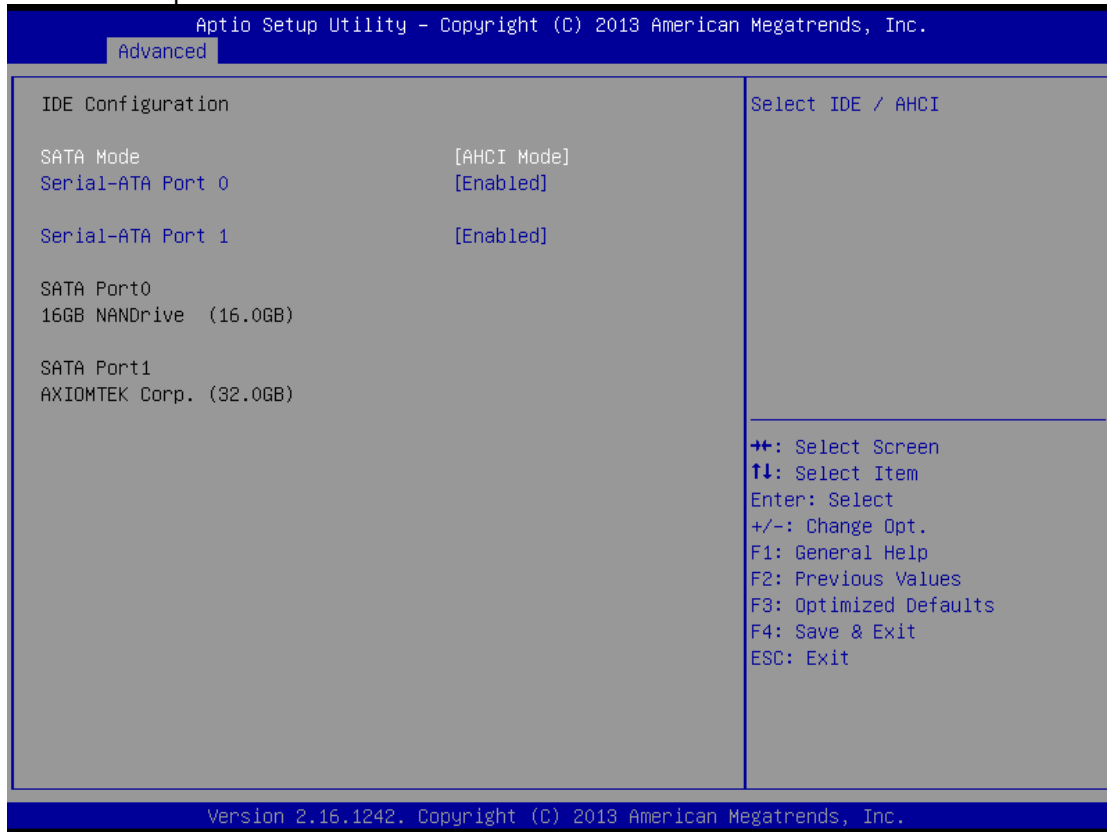

● **SATA Mode**

Use this item to choose the SATA operation mode. Here are the options for your selection, IDE Mode, AHCI Mode.

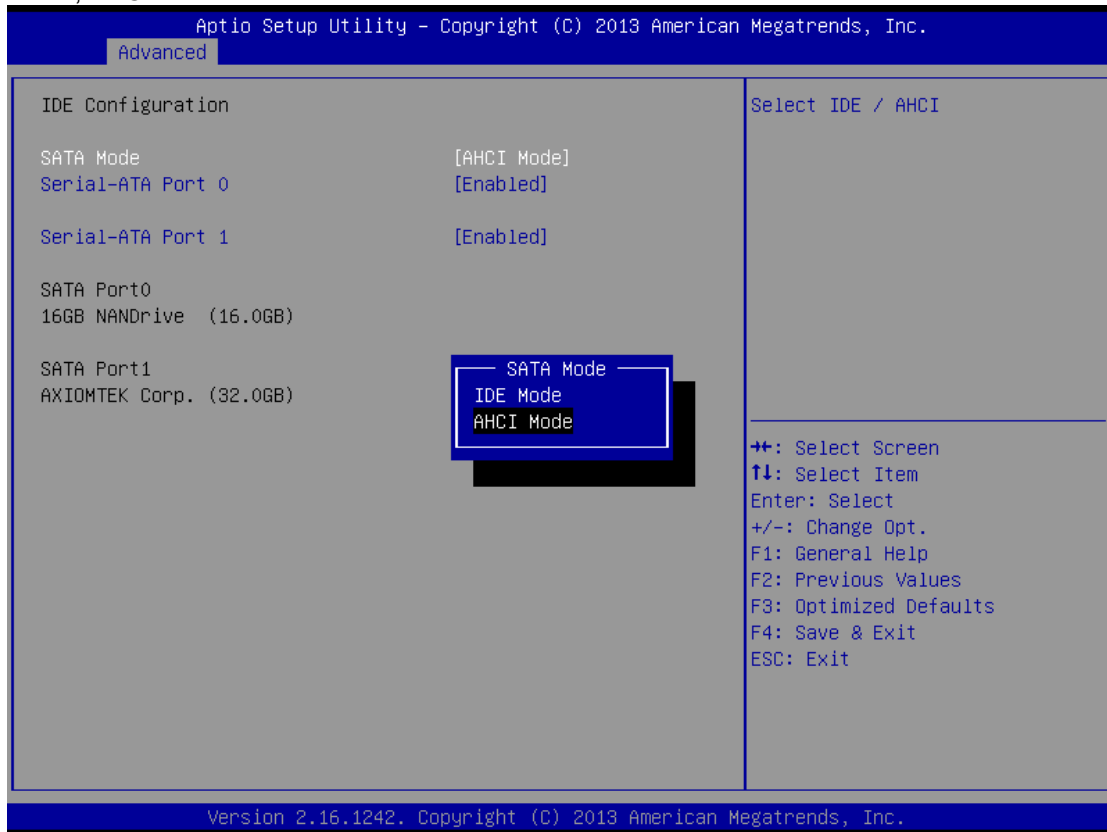

● **Miscellaneous Configuration**

Use this screen to select options for different OS, Windows8.X, Android, Windows7.

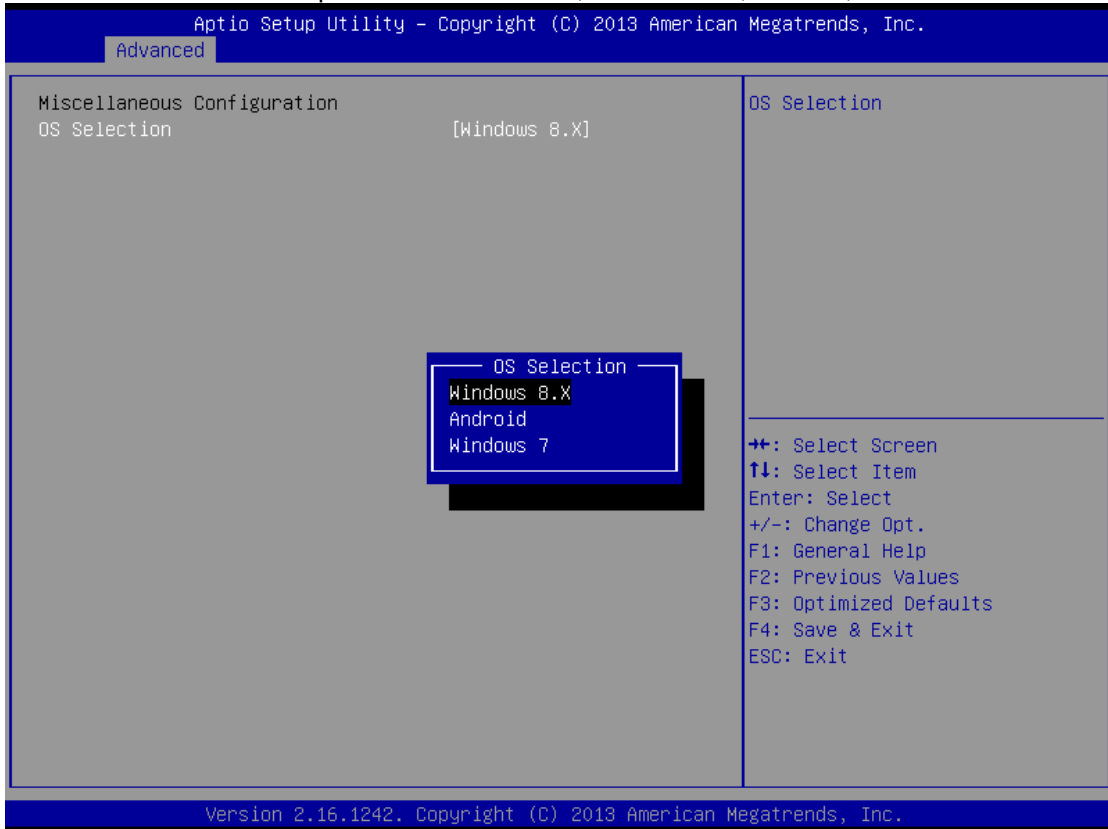

● **CSM Configuration**

Enable is Legacy mode, Disable is UEFI mode.

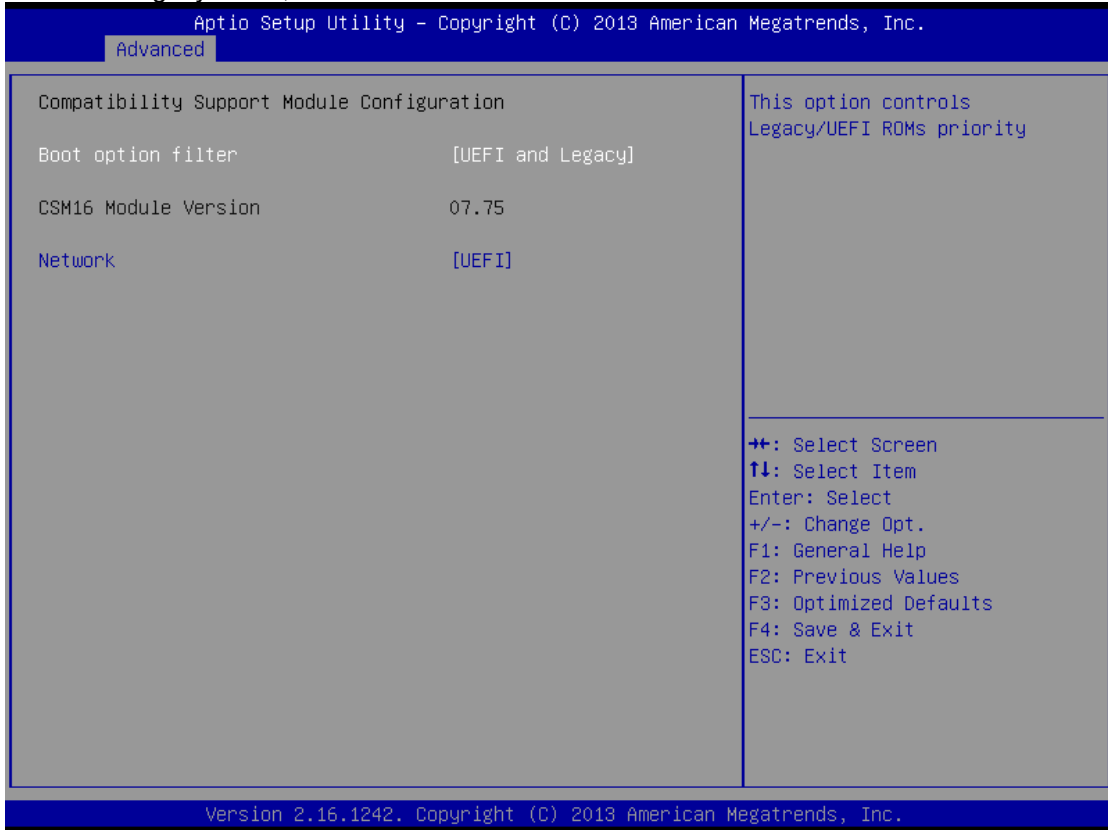

● **USB Configuration**

Display USB Device Configuration

Aptio Setup Utility - Copyright (C) 2013 American Megatrends, Inc.

Advanced

USB Configuration	Mass storage device emulation type. 'AUTO' enumerates devices according to their media format. Optical drives are emulated as 'CDROM', drives with no media will be emulated according to a drive type.
USB Module Version 8.11.01	
USB Devices: 1 Drive, 2 Keyboards, 2 Hubs	
Mass Storage Devices: JetFlashTranscend 32GB 1100 [Auto]	

⇐: Select Screen
↑↓: Select Item
Enter: Select
+/-: Change Opt.
F1: General Help
F2: Previous Values
F3: Optimized Defaults
F4: Save & Exit
ESC: Exit

Version 2.16.1242. Copyright (C) 2013 American Megatrends, Inc.

3.6 Chipset Menu

In this section, it will display the available devices on your system for you to configure the boot settings and the boot priority.

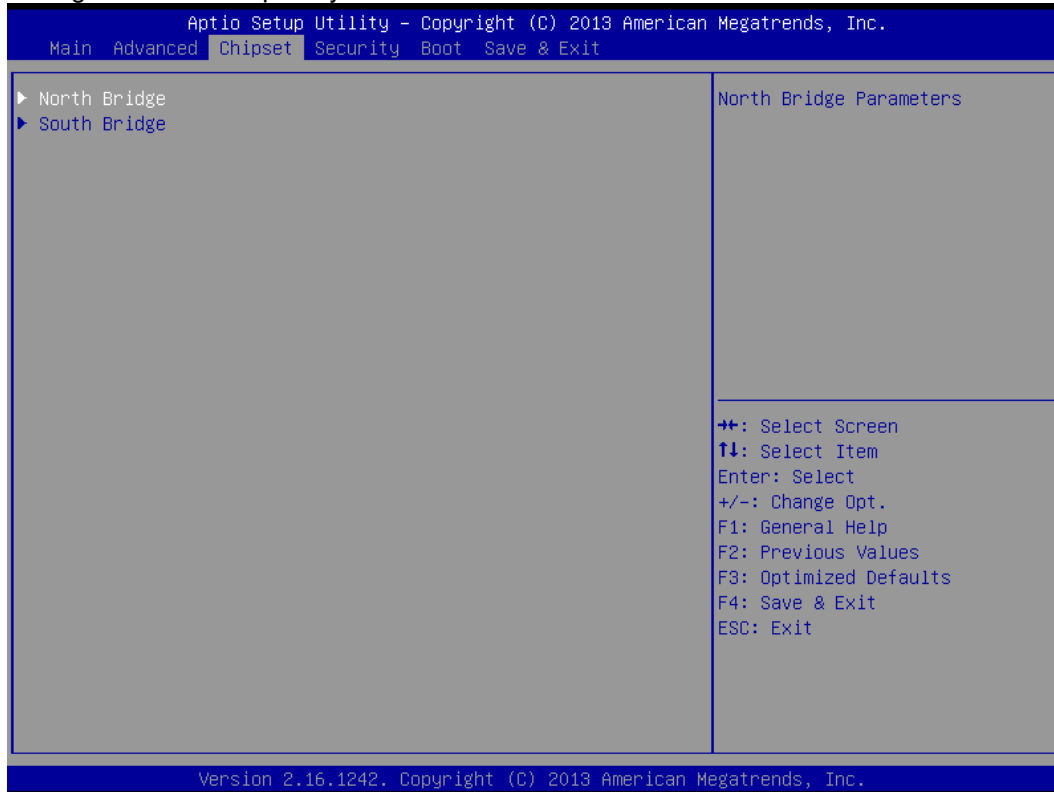

- **North Bridge**

This screen shows the North Bridge memory information.

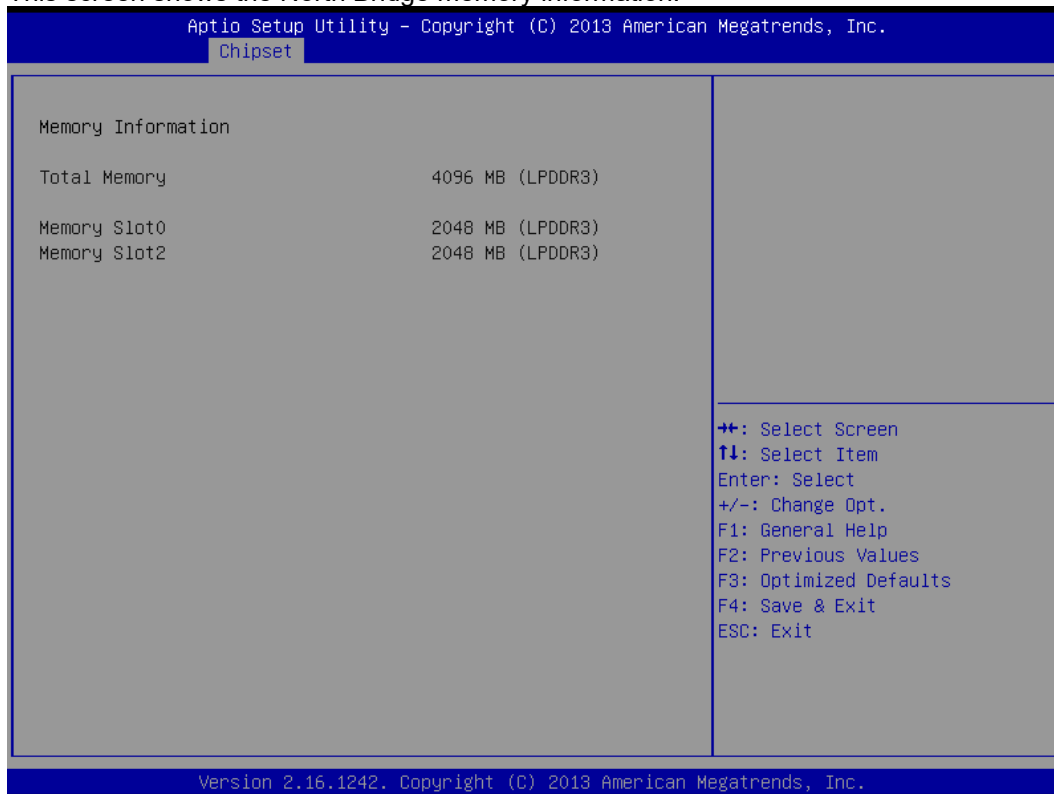

● **South Bridge**

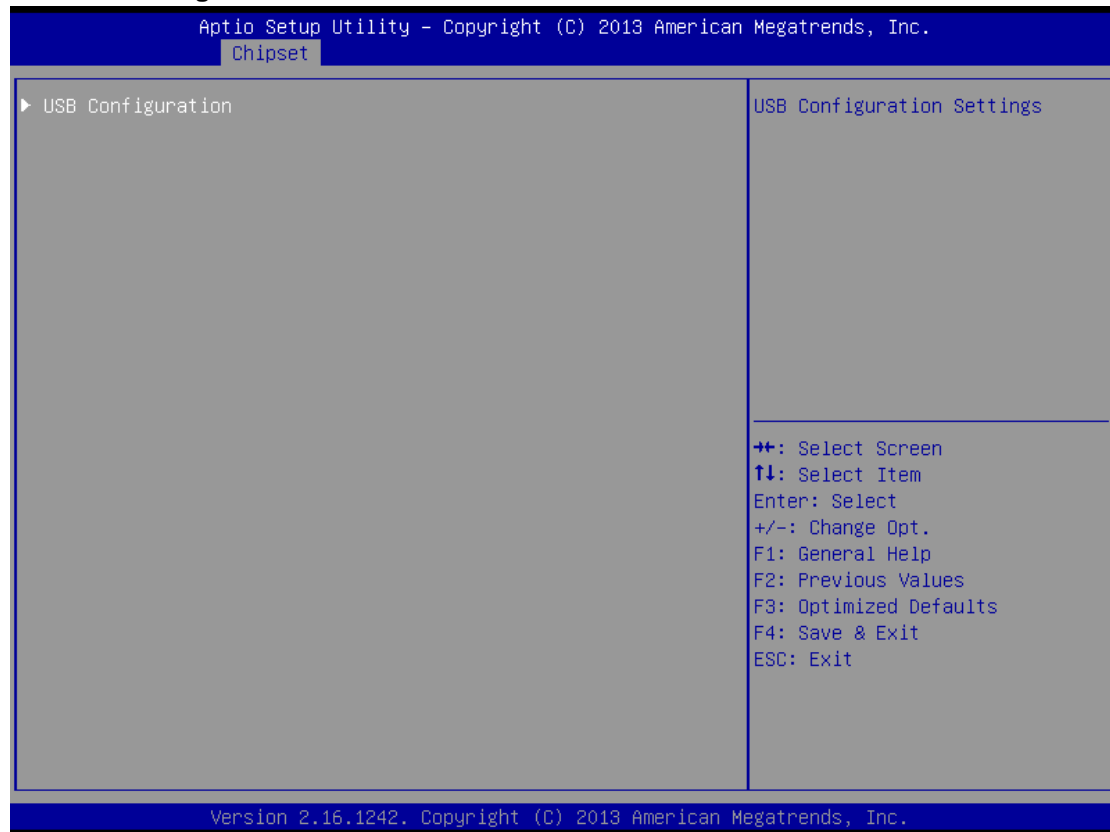

● **USB Configuration**

Only support USB2.0(EHCI).

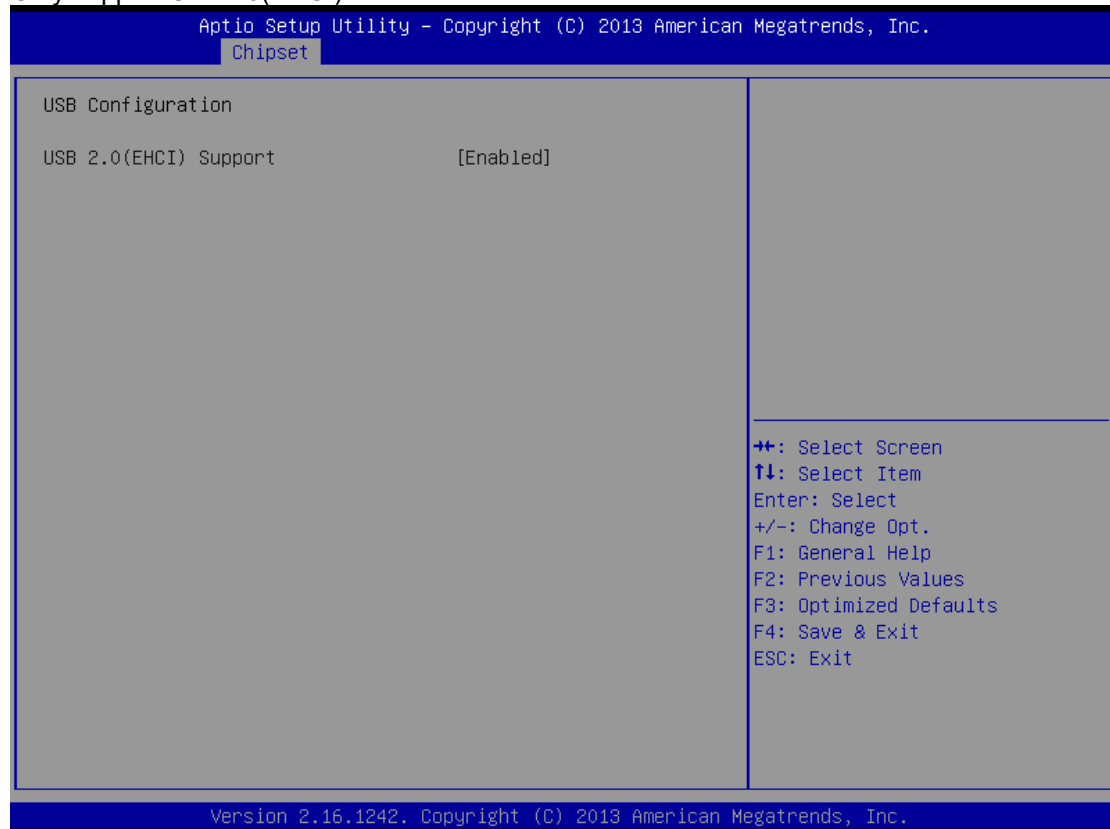

3.7 Security Menu

In this section, you may set, change or clear the supervisor/user password for the system.

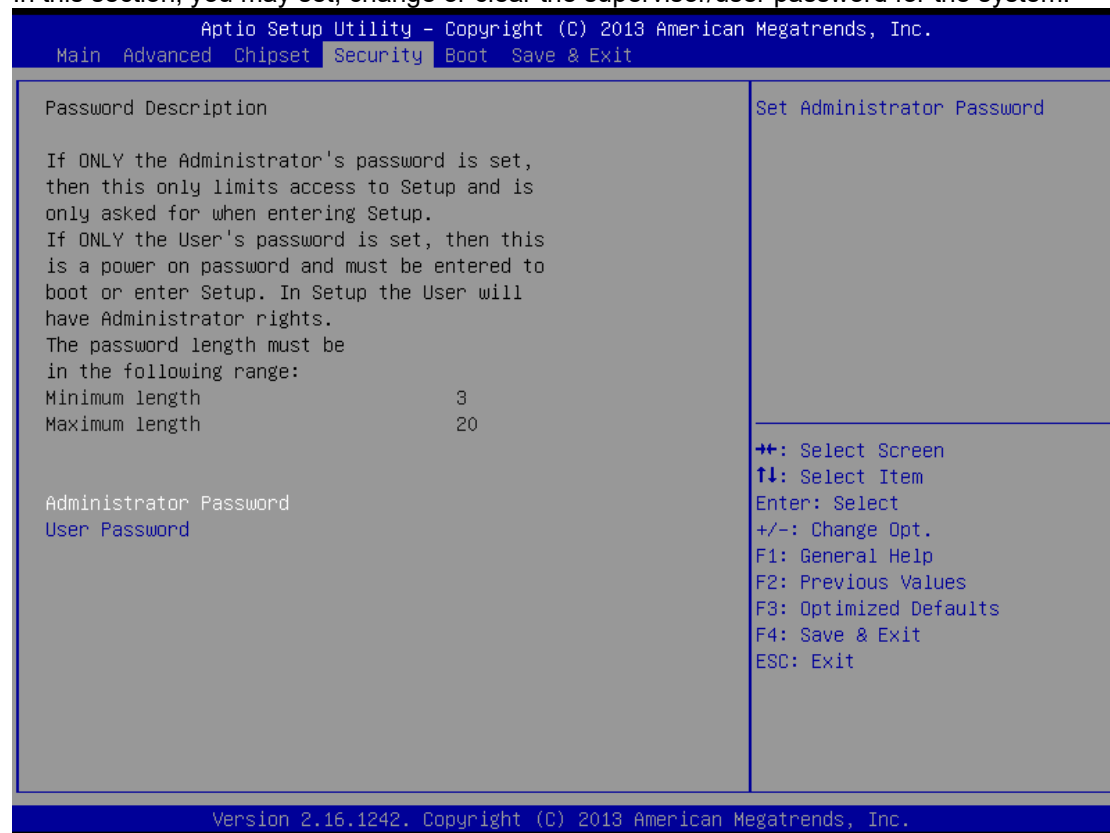

3.8 Boot Menu

The Boot menu allows users to change boot options of the system. You can select any of the items in the left frame of the screen to go to the sub menus:

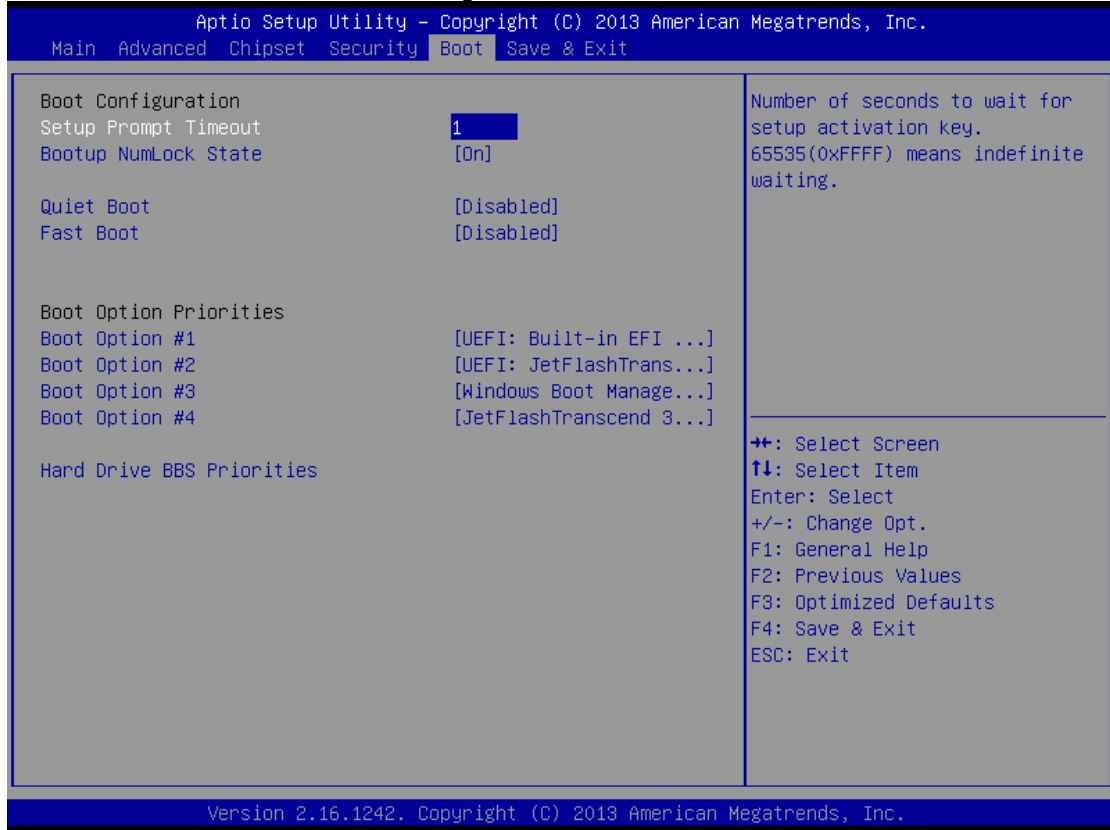

Setup Prompt Timeout

Set the Timeout for wait press key to enter Setup Menu

Bootup NumLock State

Use this item to select the power-on state for the NumLock. The default setting is on.

Quiet Boot

Use this item to enable or disable the Quite Boot state. The default setting is disable

Legacy Pxe OPROM

Use this item to enable or disable the Preboot Execution Environment. The default setting is disable.

Boot Option Priorities

Specifies the overall boot order from the available devices.

3.9 Exit Menu



NOTE Load default before updating g TXE firmware and restart