

USER'S MANUAL

GOT321B-ADL-WCD

All-in-One
21.5" FHD TFT Fanless Touch
Panel PC

User's Manual



www.axiomtek.com

Disclaimers

This manual has been carefully checked and believed to contain accurate information. Axiomtek Co., Ltd. assumes no responsibility for any infringements of patents or any third party's rights, and any liability arising from such use.

Axiomtek does not warrant or assume any legal liability or responsibility for the accuracy, completeness or usefulness of any information in this document. Axiomtek does not make any commitment to update the information in this manual.

Axiomtek reserves the right to change or revise this document and/or product at any time without notice.

No part of this document may be reproduced, stored in a retrieval system, or transmitted, in any form or by any means, electronic, mechanical, photocopying, recording, among others, without prior written permission from Axiomtek Co., Ltd.

CAUTION

Wrong type of batteries may cause explosion. It is recommended that users only replace with the same or equivalent type of batteries as suggested by the manufacturer once properly disposing of any used ones.

©Copyright 2023 Axiomtek Co., Ltd.

All Rights Reserved

February, 2024, Version A1

Printed in Taiwan

Safety Precautions

Before getting started, please read the following important safety precautions.

1. Be sure to ground yourself to prevent static charge when installing the internal components. Use a grounding wrist strap and place all electronic components in any static-shielded devices. Most electronic components are sensitive to static electrical charge.
2. Disconnect the power cord from the GOT321B-ADL-WCD prior to any installation. Be sure both the system and the external devices are turned off. Sudden surge of power could ruin sensitive components. Make sure the GOT321B-ADL-WCD is properly grounded.
3. Do not open the system's top cover. If opening the cover for maintenance is a must, only a trained technician is allowed to do so. Integrated circuits on computer boards are sensitive to static electricity. To avoid damaging chips from electrostatic discharge, observe the following precautions:
 - Before handling a board or integrated circuit, touch an unpainted portion of the system unit chassis for a few seconds. This will help to discharge any static electricity on your body.
 - When handling boards and components, wear a grounding wrist strap available from most electronic component stores.

Trademark Acknowledgments

Axiomtek is a trademark of Axiomtek Co., Ltd.

Windows[®] is a trademark of Microsoft Corporation.

Intel[®] and Pentium[®] are trademarks of Intel Corporation.

AMI is trademark of American Megatrend Inc.

Other brand names and trademarks are the properties and registered brands of their respective owners.

Table of Contents

Disclaimers.....	ii
Safety Precautions.....	iii
Section 1 Introduction.....	1
1.1 General Description	1
1.2 Specifications.....	2
1.3 Dimensions and Outlines	4
1.4 I/O Outlets	6
1.5 Packing List.....	8
Section 2 Hardware and Installation	9
2.1 Jumper Settings	9
2.1.1 COM1 Data/Power Select (JP1).....	10
2.1.2 Clear CMOS (JP3)	10
2.2 Connectors.....	11
2.2.1 COM D-Sub Connector (CN1, CN17)	12
2.2.2 USB 3.2 GEN1 Stack Port (CN10).....	12
2.2.3 USB 2.0 Stack Port (CN11)	12
2.2.4 Ethernet Ports (LAN1 and LAN2).....	13
2.2.5 PCI-Express Mini Card Connector (CN21)	14
2.2.6 M.2 Key E Socket (CN22)	15
2.2.7 HDMI1.4 Connector (CN6).....	16
2.2.8 Audio Jack (CN14)	16
2.2.9 SIM Card Slot (CN25)	17
2.2.10 Remote Power Switch Connector (PWRBT1).....	17
2.3 Mounting Methods	18
2.4 Hardware Installation	20
2.4.1 Installing an SSD	20
2.4.2 DRAM Installation.....	20
2.4.3 Wireless LAN Module Installation (optional)	22
2.5 Power Input.....	23
Section 3 AMI BIOS Setup Utility	24
3.1 Starting.....	24
3.2 Navigation Keys	24
3.3 Main Menu.....	26
3.4 Advanced Menu.....	27

USB Configuration 3.5 Chipset Menu	36
3.6 Boot Menu.....	40
3.7 Security Menu.....	41
3.8 Save & Exit Menu.....	42
Section 4 Drivers Installation	43
4.1 Operating System	43
4.1.1 Driver download.....	43
4.2 Touch Screen.....	44
Appendix A TPM BitLocker Settings.....	45

This page is intentionally left blank.

Section 1

Introduction

This Section contains general information and detailed specifications of the GOT321B-ADL-WCD, including the following Subsections:

Figure 1-1 Front View of the GOT321B-ADL-WCD



- **General Description**
- **Specification**
- **Dimensions and Outlines**
- **I/O Outlets**
- **Package List**

1.1 General Description

The GOT321B-ADL-WCD adopts a 21.5-inch FHD TFT LCD with 400-nits brightness, a high performance LGA1700 socket for 13/12th generation Intel® Core™ i7/i5/i3 & Pentium® processor (Tj 100°C) up to 35W,, and an Intel® H610 Express chipset to provide excellent computing performance. Furthermore, GOT321B-ADL-WCD support optional WLAN module & antenna for wireless connectivity.

- **Reliable and stable design**

The GOT321B-ADL-WCD adopts industrial-grade front bezel which incorporates the advantages of light weight, high degree of hardness, better heat releasing, easy-to-shape. With a patented anti-vibration design, the model is able to work in operation mode under 1.0G (10 ~ 500Hz), which has significantly improved system reliability and sustainability. Therefore, the GOT321B-ADL-WCD is especially suitable for most rugged industrial environments.

- **WLAN antenna supported (optional)**

The GOT321B-ADL-WCD supports a WLAN module (optional) antenna for wireless network connectivity.

- **Designed for extended operating temperature range and ingress protection**

The GOT321B-ADL-WCD's compact industrial design and fanless cooling system allow the panel PC to sustain an extended operating temperature range between -10°C and +50°C, making the system a power-efficient solution. It also features an IP65 front bezel for protection from liquid and dust.

- **Other features**

The GOT321B-ADL-WCD features one 260-pin DDR4-3200 SO-DIMM socket to support maximum system memory capacity of up to 32GB, along with one 2.5" wide temperature SATA HDD/SSD for storage needs. It also provides a full set of I/O including RS-232/422/485, USB 2.0, USB 3.2 Gen1, audio (line-out), HDMI and flexible I/O window (on board by option), as well as Gigabit Ethernet. This slim panel PC option supports panel mount, wall mount, VESA mount, and desktop stand mount to offer more installation flexibility.

1.2 Specifications

Main CPU Board

- **CPU**
 - LGA1700 socket 13/12th generation Intel® Core™ i7/i5/i3 and Pentium® processors.
- **Chipset**
 - Intel® H610.
- **System Memory**
 - 1 x 260-pin DDR4 3200MHz SO-DIMM, up to 32GB
- **BIOS**
 - AMI UEFI BIOS
- **TPM 2.0 onboard**

I/O System

- **Standard I/O**
 - 1 x Power button
 - 1 x Phoenix type connector for DC power input (Support IGN)
 - 1 x Grounding hole
 - 1 x Remote power switch
 - 2 X USB 3.2 GEN1(Type A)
 - 2 x USB 2.0(Type A)
 - 1 x COM1 RS-232/422/485
 - 1 x COM2 RS-232
 - 2 x HDMI
 - 1 x Audio Line-out
 - 1 x Flexible I/O window
- **Ethernet**
 - LAN1: 1000/100/10Mbps Gigabit/Fast Ethernet supports Wake-on-LAN, PXE with Intel® i219V.
 - LAN2: 2500/1000/100/10Mbps Gigabit/Fast Ethernet supports Wake-on-LAN, PXE with Intel® i225V.
- **Expansion**
 - 1 x M.2 Key E type 2230 with PCIe x1 and USB 2.0
 - 1 x PCI Express Mini Card (USB+PCIe signal)

- **Storage**
 - 1 x 2.5" SATA HDD(WT)/SSD (7mm and 9.5mm height, removable)
- **Power connector**
 - 1 x Phoenix type connector for DC power input

Mechanical/Environmental Specifications

- **21.5" FHD (1920 x 1080) LCD 400 nits with LED backlight**
- **Projected capacitive touch**
- **IP65 flat front bezel**
- **Weight(Net/Gross)**
 - 8.7 kg (19.18 lb)/12.40 kg (27.34 lb)
- **Dimensions**
 - 542 mm (21.34") (W) x 76.4 mm (3.01") (D) x 338 mm (13.31") (H)
- **Operation temperature**
 - -10°C to 50°C
- **Relative humidity**
 - 10% to 95% @ 40°C, non-condensing
- **System power Input**
 - 9 to 36V DC-in (typical 12/24VDC) via terminal block



NOTE 1. All specifications and images are subject to change without notice.
2. The performance of system might be adversely affected at an operating temperature above 40°C.

1.3 Dimensions and Outlines

Below shows the outlines and dimensions of GOT321B-ADL-WCD.

Dimension: 542 mm (21.34") (W) x 76.4 mm (3.01") (D) x 338 mm (13.31") (H)

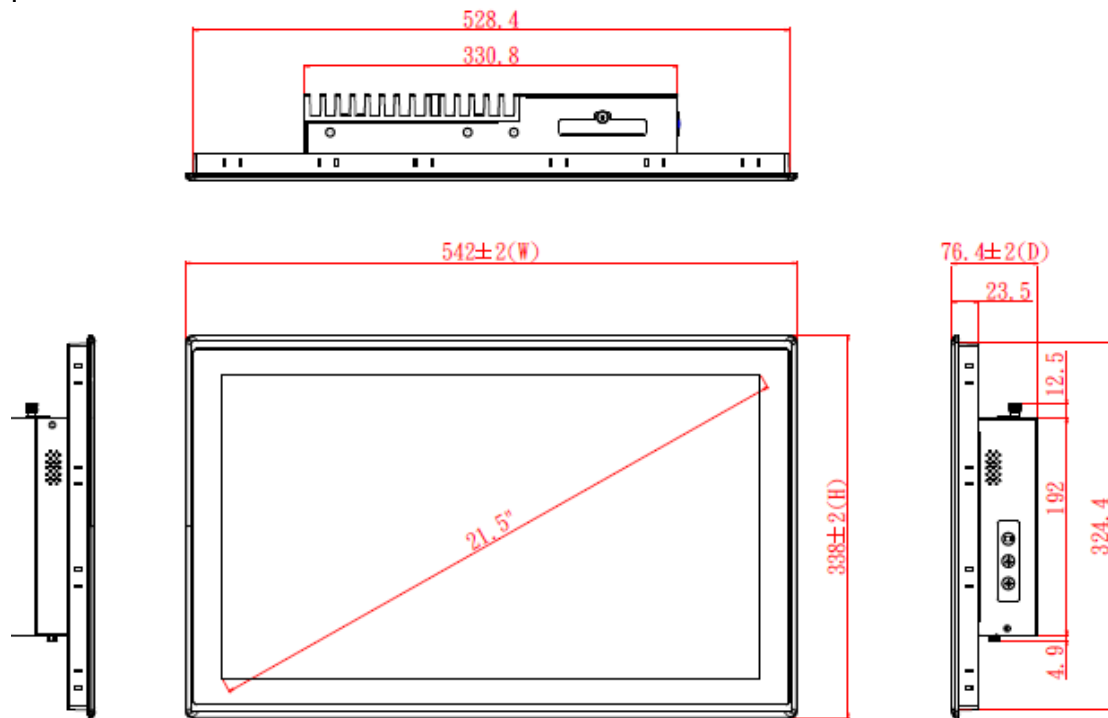

Cut out dimension of GOT321B-ADL-WCD: 397 x 253 mm

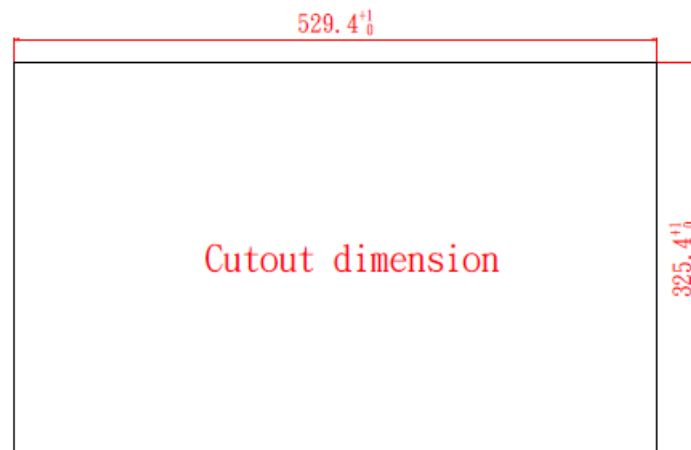

Back outline of the GOT321B-ADL-WCD

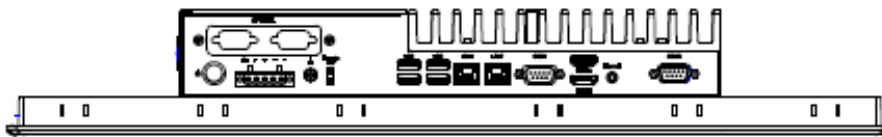
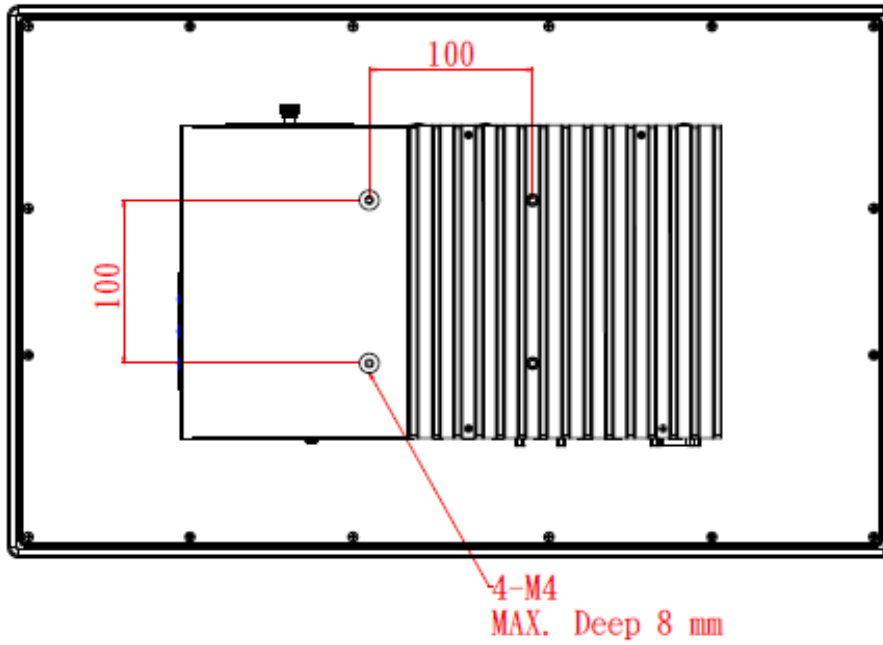

NOTE The limited od wall depth is 6mm in panel mount.

1.4 I/O Outlets

Figure 1-2,1-3 and Table 1-1,1-2 illustrate I/O locations and their functions of the GOT321B-ADL-WCD.

Figure 1-2 Side View of the GOT321B-ADL-WCD



Table 1-1 Functions of the Side panel of the GOT321B-ADL-WCD

No	Function
1	1 x Display monitor ON/OFF
2	1 x Brightness up
3	1 x Brightness down

Figure 1-3 Side View of the GOT321B-ADL-WCD

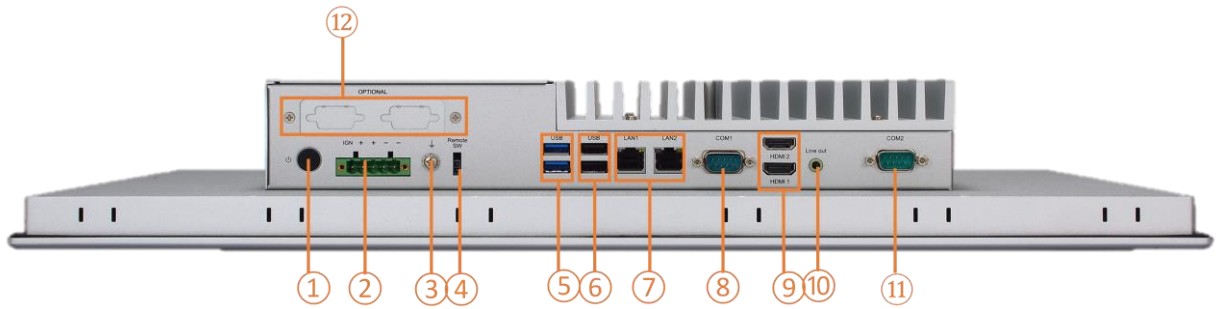

Table 1-2 Functions of the I/O Outlets of the GOT321B-ADL-WCD

No	Function
1	Power Button
2	Phoenix type connector(Support IGN)
3	Grounding hole
4	Remote power switch
5	USB 3.2 Gen1
6	USB 2.0
7	LAN
8	COM1 RS-232/422/485
9	HDMI
10	Audio Line-out
11	COM2 RS-232
12	Flexible I/O window

1.5 Packing List

The package bundled with the GOT321B-ADL-WCD should contain the following items:

- **GOT321B-ADL-WCD x 1**
- **Panel mount kit set x1**
- **Wall mount (optional)**
- **Phoenix terminal x 1**

If any above-mentioned item is missing, please contact an Axiomtek distributor immediately.

Section 2

Hardware and Installation

The GOT321B-ADL-WCD provides rich I/O ports and flexible expansion features for users to perform various tasks. This section provides detailed information on the hardware components of the panel PC as well as installation instructions, including the following subsections:

- Jumper and Connector Settings
- Mounting Methods
- Hardware Installation
- Power input

2.1 Jumper Settings

A jumper is a small component consisting of a jumper clip and jumper pins. Proper configuration of jumper settings enables the GOT321B-ADL-WCD to meet various application purposes.

The illustration below shows how to set up jumpers: Place the jumper clip on two jumper pins to close the jumper pins; remove the jumper clip from two jumper pins to open the jumper pins.

Figure 2-1: Definitions of pin settings

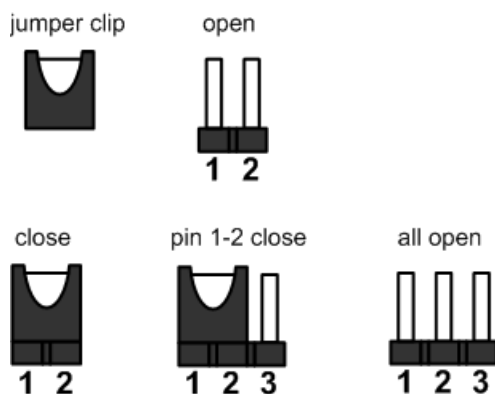

Before applying power to the GOT321B-ADL-WCD series, please make sure the jumpers are in default positions which are defined as follows:



Note

In case that default jumper setting needs to be changed, please make any change under the power-off condition.

Table 2-1 Jumper Settings

Jumper	Description	Setting
JP1	COM Data/Power Select Default: RS-232 Data	3-5 Close
		4-6 Close
JP3	Clear CMOS Default: Normal Operation	1-2 Close

2.1.1 COM1 Data/Power Select (JP1)

The COM1 port has +5V power capability on DCD and +12V on RI by setting JP1.

Function	Setting
Power: Set COM1 pin 1 to +5V	1-3 close
Data: Set COM1 pin 1 to DCD (Default)	3-5 close
Power: Set COM1 pin 9 to +12V	2-4 close
Data: Set COM1 pin 9 to RI (Default)	4-6 close

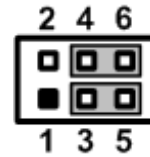

2.1.2 Clear CMOS (JP3)

This jumper allows you to clear the Real Time Clock (RTC) RAM in CMOS. You can clear the CMOS memory of date, time, and system setup parameters by erasing the CMOS RTC RAM data. The onboard button cell battery powers the RAM data in CMOS, which includes system setup information such as system passwords.

To erase the RTC RAM:

1. Turn OFF the computer and unplug the power cord.
2. Remove the onboard battery.
3. Move the jumper clip from pins 1-2 (default) to pins 2-3. Keep the clip-on pins 2-3 for about 5~10 seconds, then move the clip back to pins 1-2.
4. Re-install the battery.
5. Plug the power cord and turn ON the computer.
6. Hold down the key during the boot process and enter BIOS setup to re-enter data.

Function	Setting
Normal operation (Default)	1-2 close
Clear CMOS	2-3 close



2.2 Connectors

Signals go to other parts of the system through connectors. Loose or improper connection might cause problems, please make sure all connectors are properly and firmly connected. Here is a summary table showing connectors on the hardware.

Connector	Description
COM1, COM2	COM D-Sub Connector
CN6	HDMI1.4 Connector
CN10	USB 3.2 GEN1 Stack Port
CN11	USB 2.0 Stack Port
LAN1, LAN2	LAN Connectors
CN14	Audio Jack
CN21	PCI-Express Mini Card Connector
CN22	M.2 Key E Socket
CN25	SIM Card Slot
PWRBT1	Remote Power Switch Connector

2.2.1 COM D-Sub Connector (CN1, CN17)

The CN1, CN17 is 9-pin D-Sub connector for COM1, COM2 serial port interfaces on the rear I/O. The COM1 supports RS-232/422/485 mode and the COM2 support only RS-232. The pin assignments of RS-232/422/485 are listed in table below.

Table 2-2 Pin assignment for RS-232/ 422/ 485

Pin	RS-232 (3T/5R)	RS-422 (1T/1R Full Duplex)	RS-485 (1T/1R TX Enable Low Active)
1	DCD [1]	TX (-)	Data (-)
2	RXD	TX (+)	Data (+)
3	TXD	RX (+)	NC
4	DTR	RX (-)	NC
5	GND	GND	GND
6	DSR	NC	NC
7	RTS	NC	NC
8	CTS	NC	NC
9	RI [1]	NC	NC

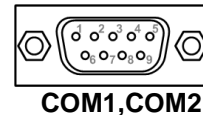

Note

Pin 1 of COM1 can be DCD/+5V and pin 9 of COM1 can be RI/+12V by selecting JP1.

2.2.2 USB 3.2 GEN1 Stack Port (CN10)

The motherboard comes with one stacked Universal Serial Bus (compliant with USB 3.2 GEN1) connector on the rear I/O for installing USB peripherals such as a keyboard, mouse, scanner, etc.

Pin	Signal	Pin	Signal
1	USB_PWR	10	USB_PWR
2	USB#1_D-	11	USB#2_D-
3	USB#1_D+	12	USB#2_D+
4	GND	13	GND
5	SSRX1-	14	SSRX2-
6	SSRX1+	15	SSRX2+
7	GND	16	GND
8	SSTX1-	17	SSTX2-
9	SSTX1+	18	SSTX2+

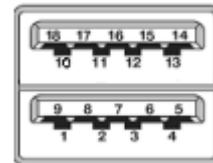

2.2.3 USB 2.0 Stack Port (CN11)

The motherboard comes with one stacked Universal Serial Bus (compliant with USB 2.0) connector on the rear I/O for installing USB peripherals such as keyboard, mouse, scanner, etc.

Pin	Signal	Pin	Signal
1	USB_PWR	2	USB_PWR
3	USB#5_D-	4	USB#6_D-
5	USB#5_D+	6	USB#6_D+
7	GND	8	GND

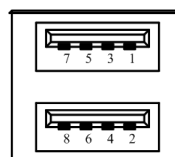

2.2.4 Ethernet Ports (LAN1 and LAN2)

The motherboard supports two Ethernet ports (CN9, CN12): two RJ45 connectors with LAN1: Intel® i219-V controller support 10/100/1000 Mbps.

LAN2: Intel® i225-V controller support 10/100/1000/2500Mbps.

Pin	LAN2 Signal	Pin	LAN1 Signal
L1	Tx+ (Data transmission positive)	L2	Tx- (Data transmission negative)
L3	Rx+ (Data reception positive)	L4	RJ-1 (For 1000 Base-T only)
L5	RJ-1 (For 1000 Base-T only)	L6	Rx- (Data reception negative)
L7	RJ-1 (For 1000 Base-T only)	L8	RJ-1 (For 1000 Base-T only)
A	Speed LED LAN1: Intel® i219-V OFF: 10Mbps data rate Green: 100Mbps data rate Orange: 1Gbps data rate LAN2: Intel® i225-V OFF: 10/100Mbps data rate Green: 1Gbps data rate Orange: 2.5Gbps data rate	B	Active LED(Yellow) OFF: No link Blinking: Link established; data activity detected

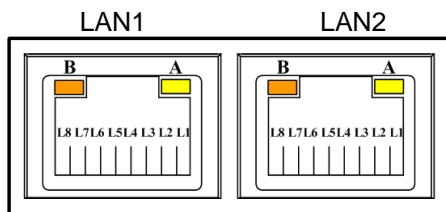

CN9/CN12 supports Wake-on-LAN.

Note

2.2.5 PCI-Express Mini Card Connector (CN21)

The CN21 complies with PCI-Express Mini Card Spec. V1.2.

Pin	Signal	Pin	Signal
1	WAKE#	2	+3.3VAUX
3	NC	4	GND
5	NC	6	+1.5V
7	CLKREQ#	8	UIM_PWR/NC
9	GND	10	UIM_DAT/NC
11	REFCLK-	12	UIM_CLK/NC
13	REFCLK+	14	UIM_REST/NC
15	GND	16	UIM_VPP/NC
17	NC	18	GND
19	NC	20	NC
21	GND	22	PERST#
23	PCIE_RX_D-	24	+3.3VAUX
25	PCIE_RX_D+	26	GND
27	GND	28	+1.5V
29	GND	30	SMB_CLK
31	PCIE_TX_D-	32	SMB_DATA
33	PCIE_TX_D+	34	GND
35	GND	36	USB_D-
37	GND	38	USB_D+
39	+3.3VAUX	40	GND
41	+3.3VAUX	42	NC
43	GND	44	NC
45	NC	46	NC
47	NC	48	+1.5V
49	NC	50	GND
51	NC	52	+3.3VAUX

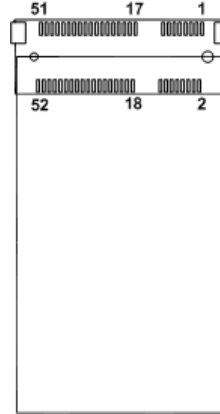

2.2.6 M.2 Key E Socket (CN22)

The motherboard comes with one M.2 Key E socket (PCIe & USB2.0), The CN22 supports CNVi module.

Pin	Signal	Pin	Signal
1	GND	2	+3.3V_SBY
3	USB_D+	4	+3.3V_SBY
5	USB_D-	6	NC
7	GND	8	M.2_BT_PCMCLK
9	CNVI_WGR_DATA1_D-	10	M.2_BT_PCMRST
11	CNVI_WGR_DATA1_D+	12	M.2_BT_PCMIN
13	GND	14	M.2_BT_PCMIOUT
15	CNVI_WGR_DATA0_D-	16	NC
17	CNVI_WGR_DATA0_D+	18	GND
19	GND	20	UART_BT_WAKE-
21	CNVI_WGR_CLK_D-	22	CNVI_BRI_RSP
23	CNVI_WGR_CLK_D+	24	Key E
25	Key E	26	
27		28	
29		30	
31		32	
33		GND	34
35	PCIE_TX_+	36	CNVI_RGI_RSP
37	PCIE_TX_-	38	CNVI_BRI_DT
39	GND	40	CL_RST
41	PCIE_RX_+	42	CL_DATA
43	PCIE_RX_-	44	CL_CLK
45	GND	46	CNVI_GNSS_PA_BLANKING
47	CLK_PCIE_+	48	CNVI_MFUART_TXD
49	CLK_PCIE_-	50	CNVI_MFUART_RXD
51	GND	52	SUSCLK (+3.3V Level)
53	CLKREQ0#	54	PERST# (+3.3V Level)
55	PEWAKE0#	56	BT_RF_KILL
57	GND	58	WIFI_RF_KILL
59	CNVI_WT_DATA1_D-	60	NC
61	CNVI_WT_DATA1_D+	62	NC
63	GND	64	NC
65	CNVI_WT_DATA0_D-	66	GND
67	CNVI_WT_DATA0_D+	68	NC
69	GND	70	NC
71	CNVI_WT_CLK_D-	72	NC
73	CNVI_WT_CLK_D+	74	+3.3V_SBY
75	GND		+3.3V_SBY

2.2.7 HDMI1.4 Connector (CN6)

The HDMI (High-Definition Multimedia Interface) is a compact digital interface which can transmit high-definition video and high-resolution audio over a single cable.

Pin	Signal	Pin	Signal
1	HDMI OUT_DATA2+	2	GND
3	HDMI OUT_DATA2-	4	HDMI OUT_DATA1+
5	GND	6	HDMI OUT_DATA1-
7	HDMI OUT_DATA0+	8	GND
9	HDMI OUT_DATA0-	10	HDMI OUT_CLK+
11	GND	12	HDMI OUT_CLK-
13	NC	14	NC
15	HDMI OUT_SCL	16	HDMI OUT_SDA
17	GND	18	+5V
19	HDMI_HPDET		

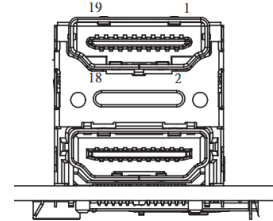

2.2.8 Audio Jack (CN14)

The motherboard provides HD audio jack on the rear I/O. Install audio driver, and then attach audio devices to CN14.

Pin Color	Signal
Green	Line-out



2.2.9 SIM Card Slot (CN25)

The CN25 is for inserting SIM Card which is mainly used in wireless network application.

Pin	Signal
1	UIM_PWR
2	UIM_RST
3	UIM_CLK
4	N/A
5	GND
6	VPP
7	DATA



2.2.10 Remote Power Switch Connector (PWRBT1)

One 2-pin connector output for remote power on/off switch.

Functions	Descriptions
Short(1-2)	Turn on/off system
Open	Keep system status

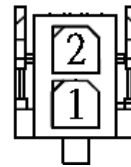

2.3 Mounting Methods



Only trained and qualified technicians are permitted to mount the product. To prevent accidental damage to the product or human injury when mounting the product, at least two people are required to perform the installation.

There are four ways to install the GOT321B-ADL-WCD, namely: panel/ VESA/ wall/ desktop mount.

The GOT321B-ADL-WCD is designed for panel mount application. To mount the GOT321B-ADL-WCD, the standard set of mounting kit (10pcs included in the system packaging) is needed. (see Diagram 2-1).

Diagram 2-1 Panel mount kit

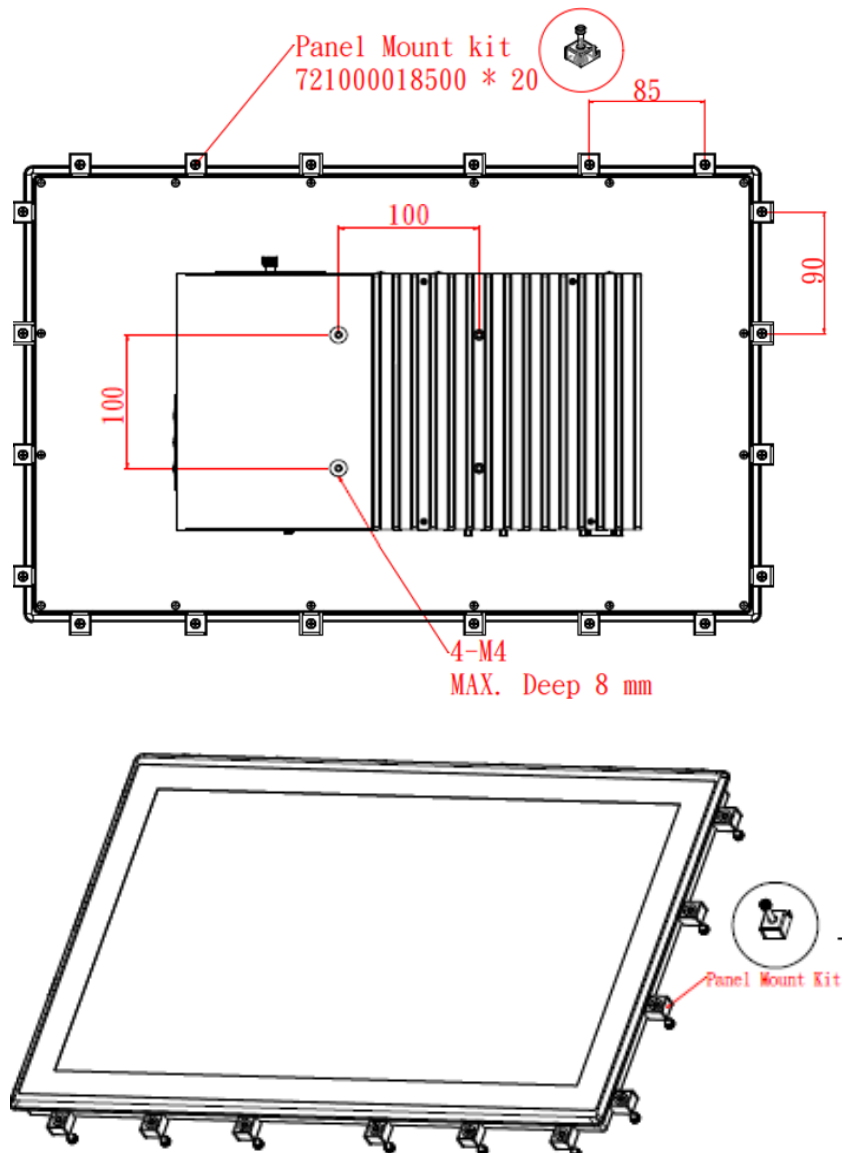

Alternatively, the GOT321B-ADL-WCD can be installed by way of VESA mount which is in the dimensions of 100x100 mm. Simply fix four screws to fasten the kit from the back chassis, as shown in Diagram 2-2. Additionally, users can otherwise go for wall mount as an option, as shown in Diagram 2-3.

Diagram 2-2 VESA / desktop mount (back chassis)

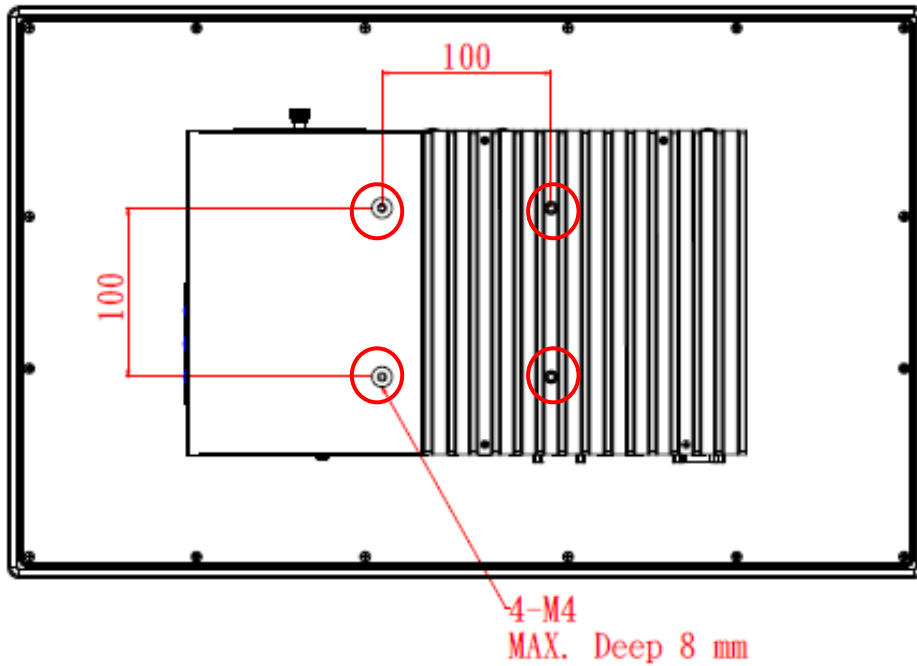
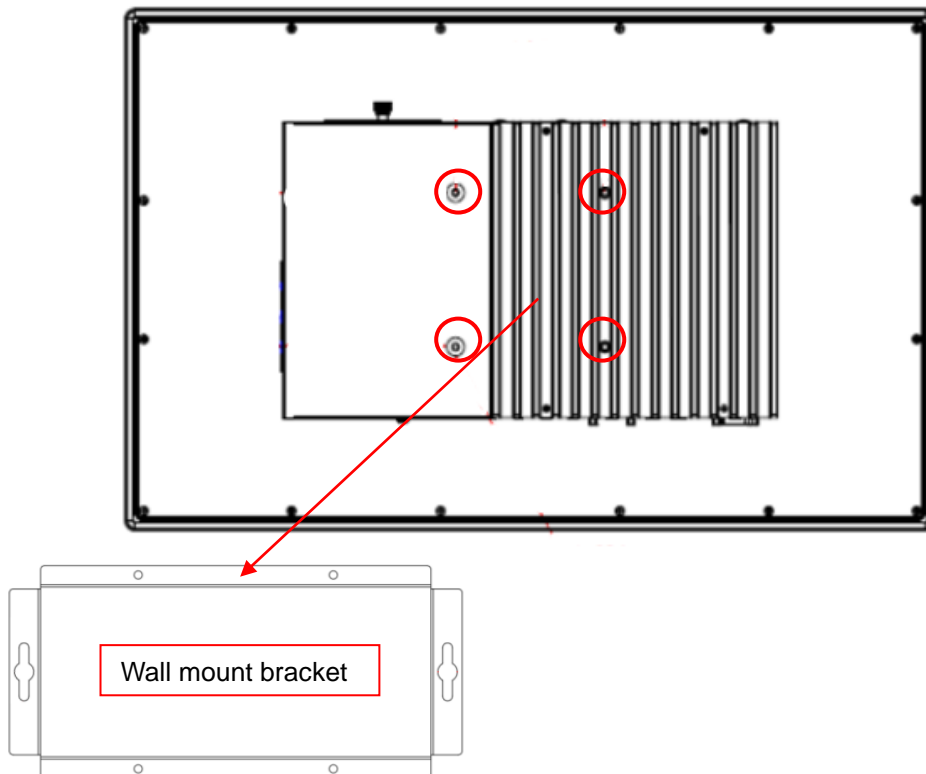

Diagram 2-3 Wall mount (back chassis)



2.4 Hardware Installation

2.4.1 Installing an SSD

The GOT321B-ADL-WCD provides a convenient SSD bracket for users to install 1 x 2.5" SATA SSD. Please follow the steps:

Step 1 Unfastening the screw to slide open.



Step 2 Insert the 2.5" SSD into the bracket and fasten the four screws on the bottom side of the bracket to hold the HDD firmly to the bracket.



Step 3 Slide the bracket back into the system unit.



Step 4 Plug the "SATA + Power" connector into the SSD.
Step 5 Fasten the bracket screw to complete installation.

2.4.2 DRAM Installation

The GOT321B-ADL-WCD provides one 260-pin DDR4 SO-DIMM socket that support system memory up to 32GB. Please follow steps below to install the memory modules:

Step 1 Open the back cover and locate the DIMM socket on the mainboard.



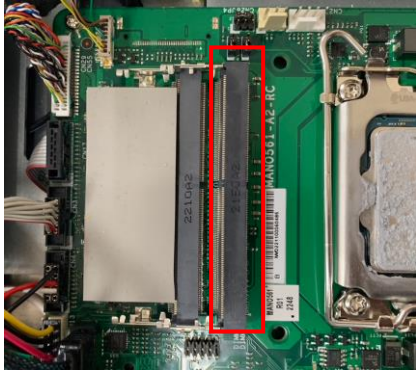

Step 2 Install the SO-DIMM module into the slot (see red frame line) and press it firmly down until it seats correctly.



Step 3 In the red box in the left picture, place the Thermal Pad on the iron block. (shown in the red frame line in the right picture)

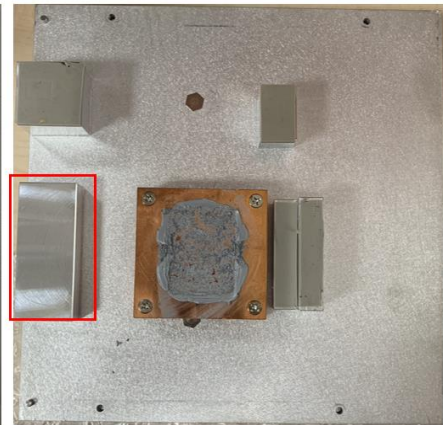
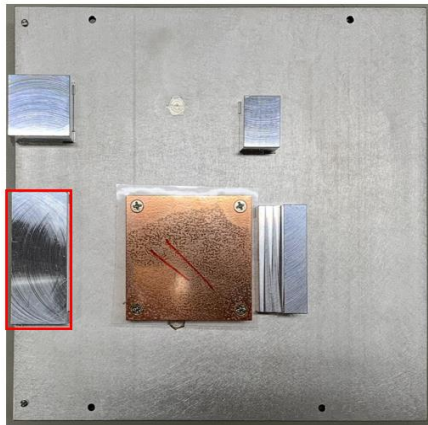

2.4.3 Wireless LAN Module Installation (optional)

The GOT321B-ADL-WCD provides optional wireless LAN module to install. When installing the wireless LAN module, refer to the following instructions and illustration:

Step 1 Open the back cover and locate PCIe Mini-Card slot.



Step 2 Insert wireless LAN module to Mini card slot and fixing it by a screw.



Step 3 Lift the rubber stopper from the top of back cover.



Step 4 Install the antenna on the antenna connector.



2.5 Power Input

The GOT321B-ADL-WCD is equipped with a Phoenix type power connector which supports 12V/19V/24VDC in. Please follow the signs on the power connector to connect to DC power source (see Figure 2-2).

Figure 2-2: Power connector

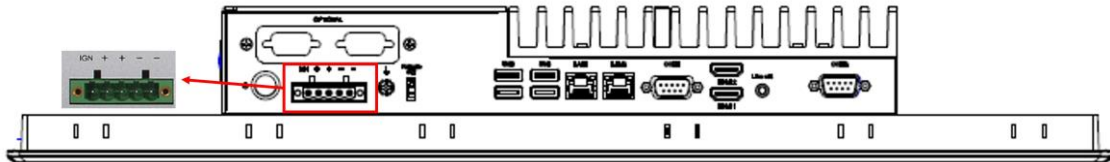

Pins	Signals
1	DC-
2	DC-
3	DC+
4	DC+
5	IGN (Max: +30V)

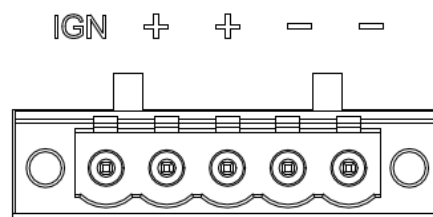

NOTE

The safety ground must be connected to ensure that the unit works appropriately.

In ACC mode, the IGN signal will only be triggered when DCIN Terminal Block's 5-Pin IGN is connected with VCC.

Section 3

AMI BIOS Setup Utility

The AMI UEFI BIOS provides users with a built-in setup program to modify basic system configuration. All configured parameters are stored in a flash chip to save the setup information whenever the power is turned off. This Section provides users with detailed description about how to set up basic system configuration through the AMI BIOS setup utility.

3.1 Starting

To enter the setup screens, follow the steps below:

1. Turn on the computer and press during the Power On Self-Test (POST) to enter BIOS setup, otherwise, POST will continue with its test routines.
2. Once you enter the BIOS, the main BIOS setup menu displays. You can access the other setup screens from the main BIOS setup menu, such as the Advanced and Chipset menus.

It is strongly recommended that you should avoid changing the chipset's defaults. Both AMI and your system manufacturer have carefully set up these defaults that provide the best performance and reliability.

3.2 Navigation Keys

The BIOS setup/utility uses a key-based navigation system called hot keys. Most of the BIOS setup utility hot keys can be used at any time during the setup navigation process. These keys include <F1>, <F9>, <F10>, <F11>, <F12>, <Enter>, <ESC>, <Arrow> keys, and so on.



NOTE: *Some of the navigation keys differ from one screen to another.*

Hot Keys	Description
→← Left/Right	The Left and Right <Arrow> keys allow you to select a setup screen.
↑↓ Up/Down	The Up and Down <Arrow> keys allow you to select a setup screen or sub screen.
Enter	The <Enter> key allows you to display or change the setup option listed for a particular setup item. The <Enter> key can also allow you to display the setup sub screens.
+– Plus/Minus	The Plus and Minus <Arrow> keys allow you to change the field value of a particular setup item.
F1	The <F1> key allows you to display the General Help screen.
F9	The <F9> key allows you to Load Optimized Defaults.
F10	The <F10> key allows you to save any changes you have made and exit Setup.
F11	The <F11> key allows you to print the BIOS setting screen.
F12	The <F12> key allows you to update BIOS.
Esc	The <Esc> key allows you to discard any changes you have made and exit the Setup. Press the <Esc> key to exit the setup without saving your changes.

3.3 Main Menu

When you first enter the setup utility, you will enter the Main setup screen. You can always return to the Main setup screen by selecting the Main tab. System Time/Date can be set up as described below. The Main BIOS setup screen is shown below.

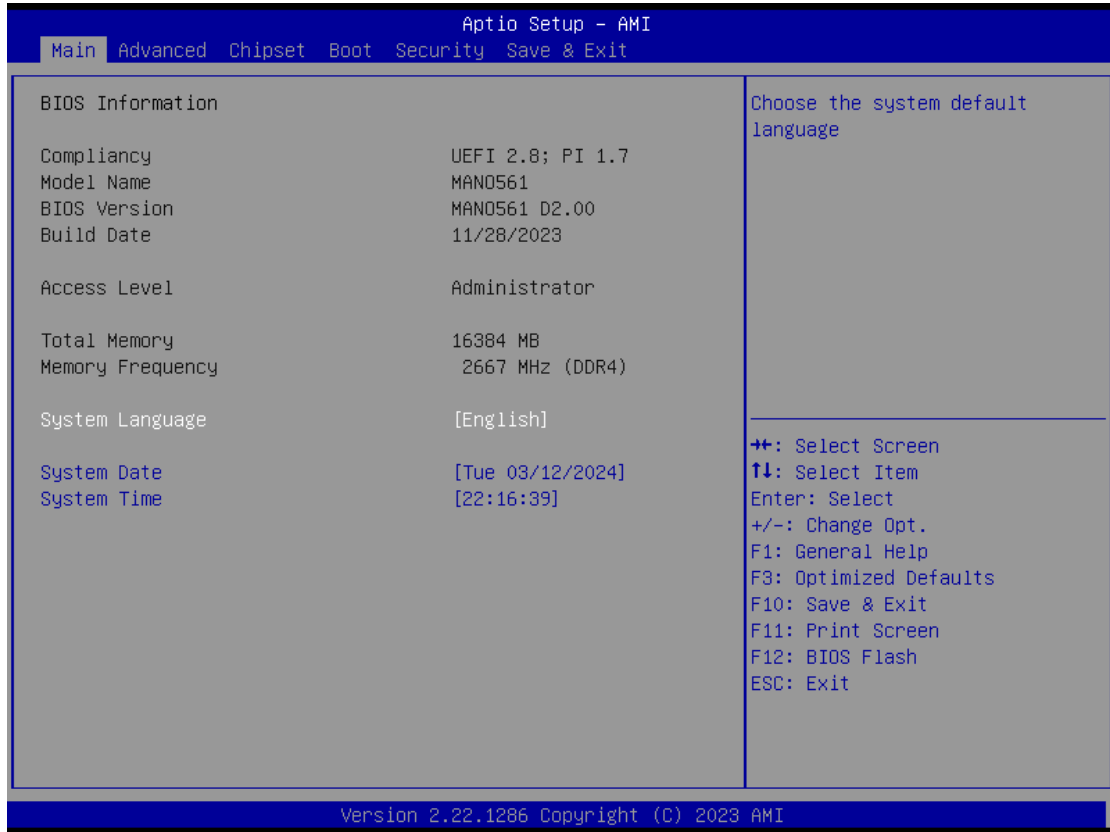

BIOS Information

Display system BIOS information.

System Language

Use this option to choose the system default language.

System Date/Time

Use this option to change the system time and date. Highlight System Time or System Date using the <Arrow> keys. Enter new values through the keyboard. Press the <Tab> key or the <Arrow> keys to move between fields. The date must be entered in MM/DD/YY format. The time is entered in HH:MM:SS format.

3.4 Advanced Menu

The Advanced menu also allows users to set configuration of the CPU and other system devices. You can select any of the items in the left frame of the screen to go to the sub menus:

- ▶ CPU Configuration
- ▶ SATA Configuration
- ▶ Trusted Computing
- ▶ ACPI Settings
- ▶ F81966 Super IO Configuration
- ▶ Hardware Monitor
- ▶ USB Configuration
- ▶ Network Stack Configuration
- ▶ NVMe Configuration (Reserve options for project use)

For items marked with“▶”, please press <Enter> for more options.

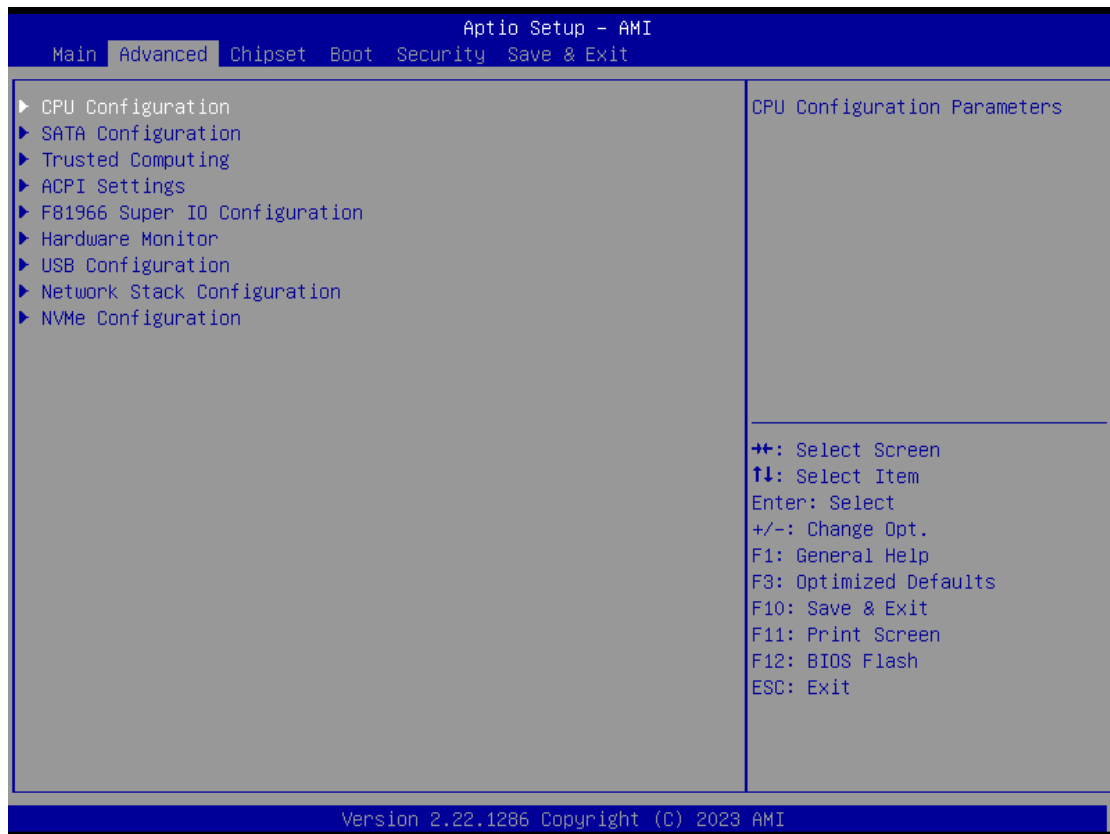

● **CPU Configuration**

This screen shows CPU information.

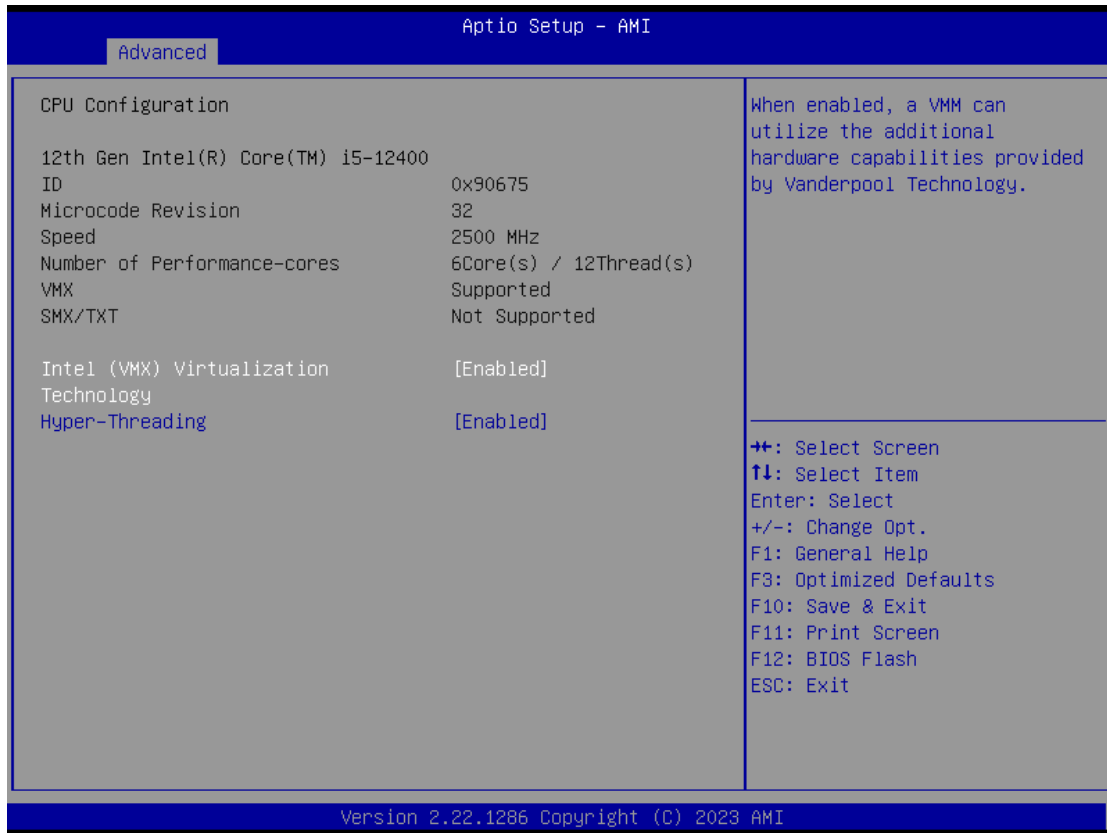

Intel (VMX) Virtualization Technology

Enable or disable Intel Virtualization Technology. When enabled, a VMM (Virtual Machine Mode) can utilize the additional hardware capabilities. It allows a platform to run multiple operating systems and applications independently, hence enabling a single computer system to work as several virtual systems.

Hyper-Threading

Enable or disable Hyper-Threading. When enabled, it allows a single physical processor to multitask as multiple logical processors. When disabled, only one thread per enabled core is enabled.

- **Trusted Computing**

This screen provides function for specifying the TPM setting.

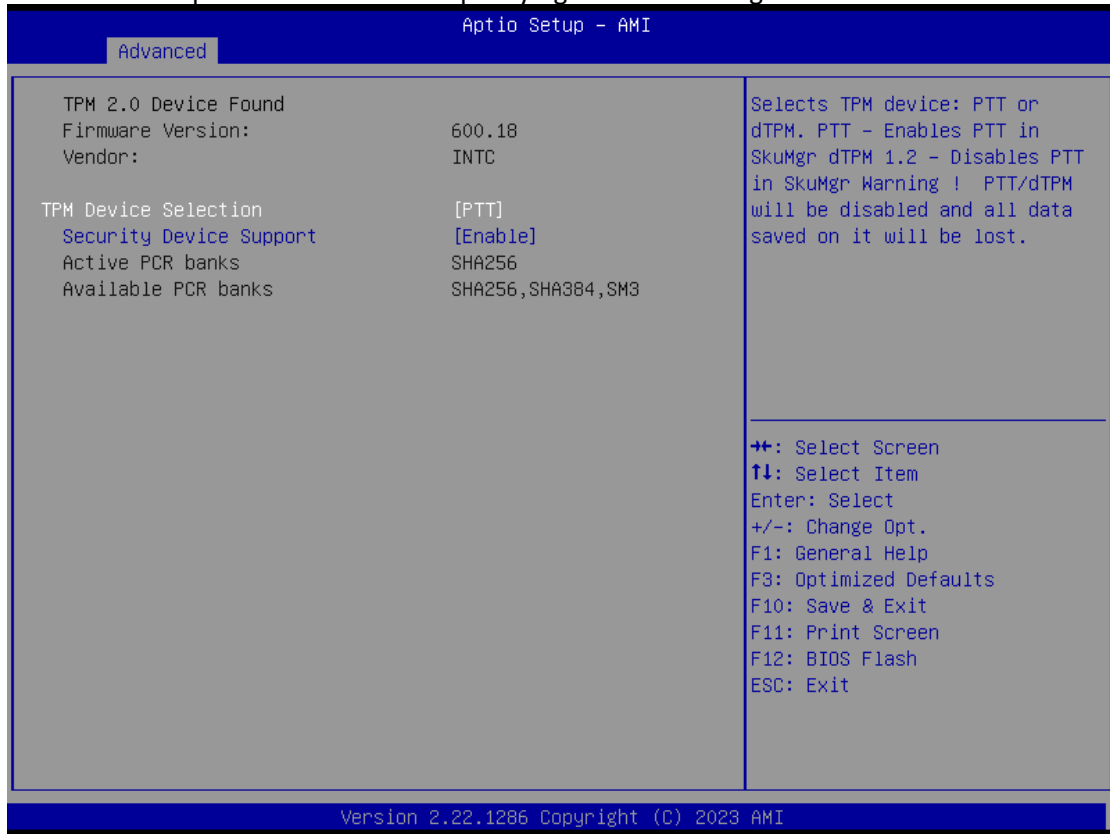

TPM Device Selection select

- PTT: Intel® build-in TPM
- dTPM: External extended TPM

Security Device Support

- Enable or disable BIOS support for security device. OS will not show security device

● **ACPI Settings**

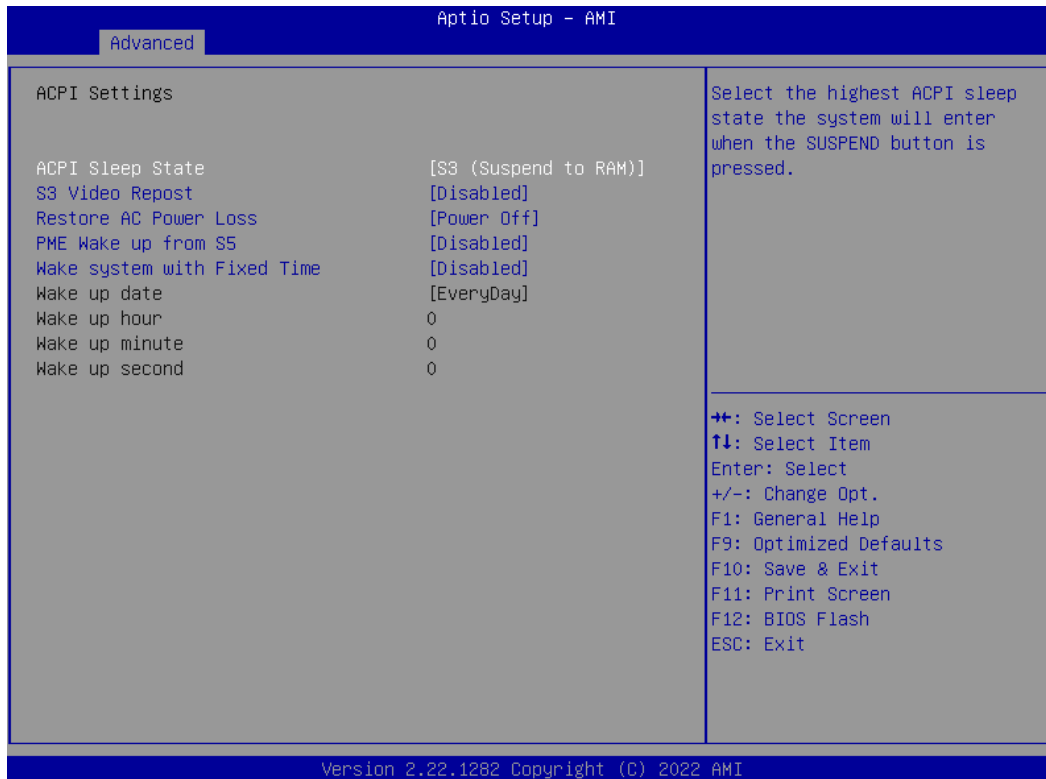

ACPI Sleep State

When the suspend button is pressed, the ACPI (Advanced Configuration and Power Interface) sleep state is S3 (Suspend to RAM).

S3 Video Repost

On enabling, Video Option ROM will be dispatched during S3 resume.

Restore AC Power Loss

Decide the state of system when power is re-applied after a power failure.

- Power Off: Keep the power off until the power button is pressed.
- Power On: Restore power to the computer.

PME Wake up from S5

Enable system to wake from S5 using PME event.

Wake System with Fixed Time

Enable or disable system wake on alarm event. When enabled, system will wake on the hr: min:sec specified..

- **F81966 Super IO Configuration**

You can use this screen to select options for the Super IO Configuration and change the value of the selected option. A description of the selected item appears on the right side of the screen. For items marked with “▶”, please press <Enter> for more options.

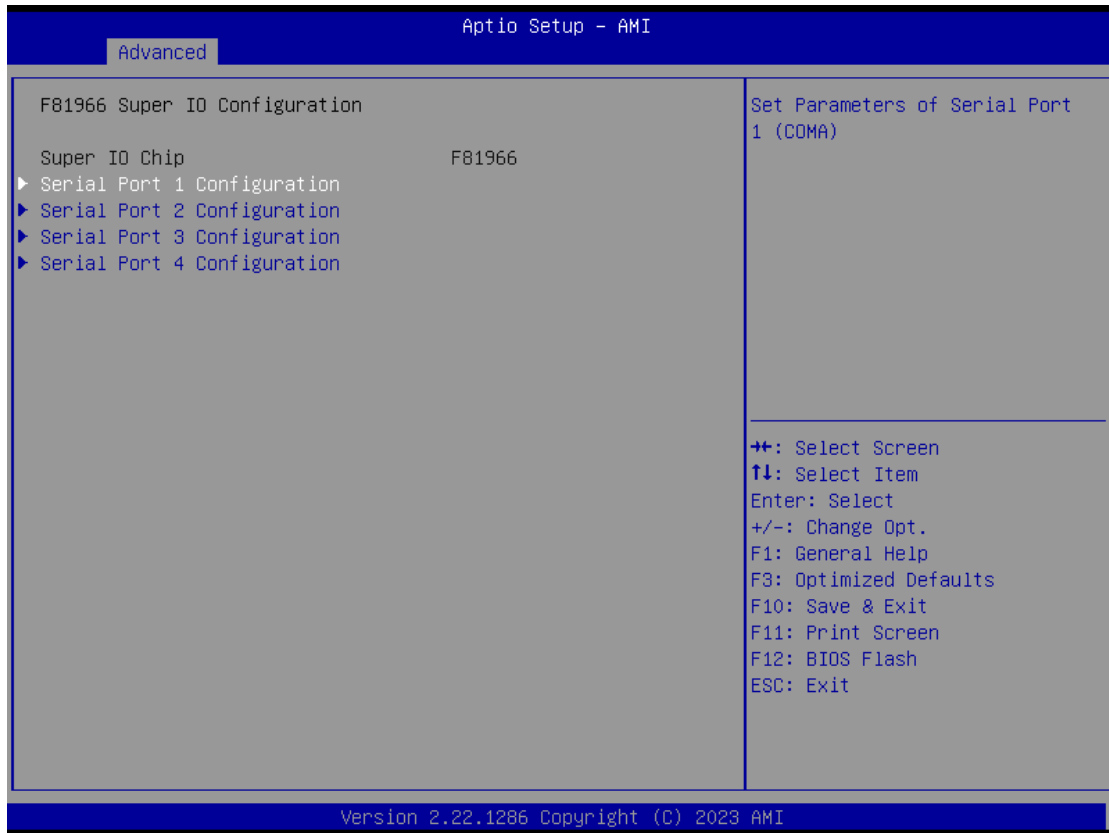

Serial Port 1~4 Configuration

Use these items to set parameters related to serial port 1~4.
Serial port 3 and 4 options are reserved for optional plug-and-play.

UART IRQ Mode

PCI IRQ sharing for OS (ex. Windows), ISA IRQ for Dos.

Watch Dog Degree

Watchdog degree selection in minute or second.

Watch Dog Timer

Watchdog timer value range from 1 to 255. Set 0 will disable watchdog timer.

● **Serial Port 1 Configuration**

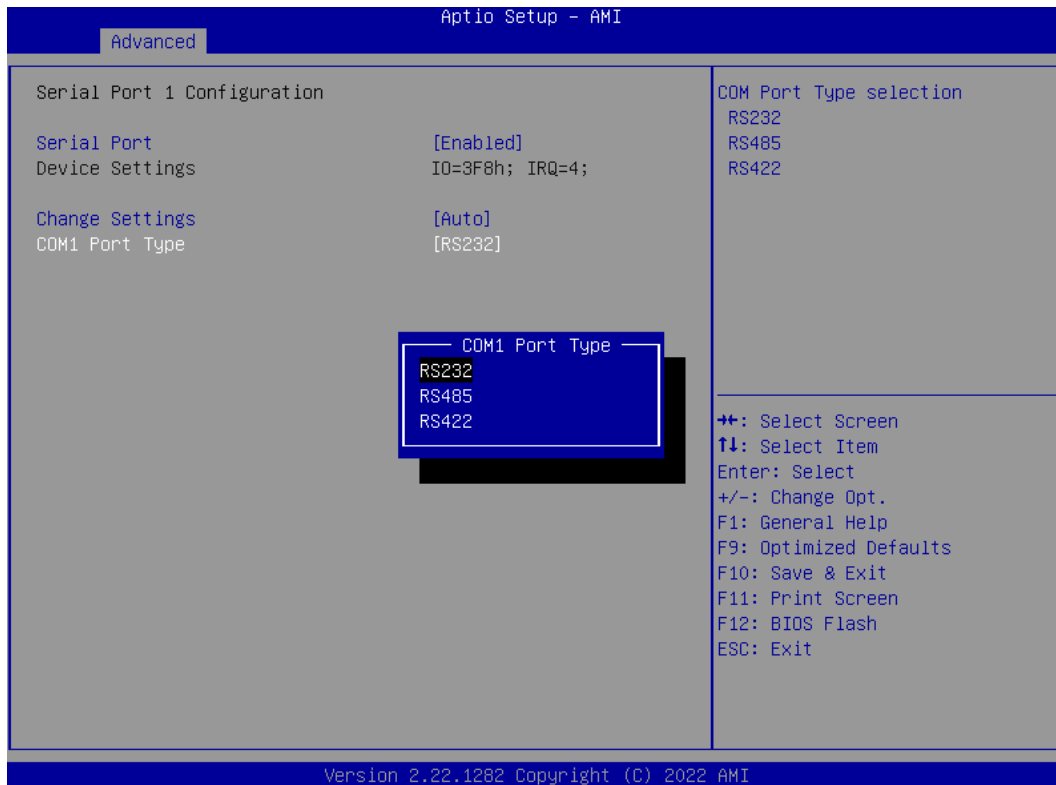

Serial Port

Enable or disable serial port 1.

Change Settings

Select an optimal setting for Super IO device.

- Auto
- IO=3F8h, IRQ=4;
- IO=3F8h, IRQ=3, 4, 5, 6, 7, 9, 10, 11, 12;
- IO=2F8h, IRQ=3, 4, 5, 6, 7, 9, 10, 11, 12;
- IO=3E8h, IRQ=3, 4, 5, 6, 7, 9, 10, 11, 12;
- IO=2E8h, IRQ=3, 4, 5, 6, 7, 9, 10, 11, 12;

COM1 Port Type

Select RS-232/422/485 mode for serial port 1.

- **Serial Port 2~4 Configuration**

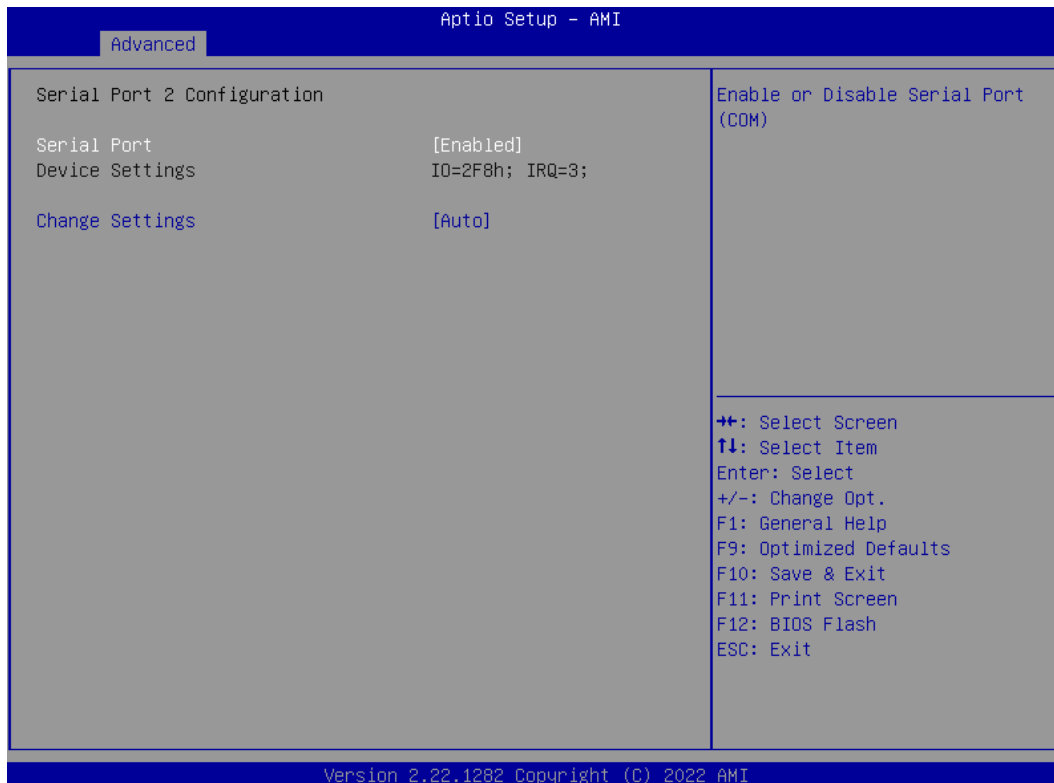

Serial Port

Enable or disable serial port 2~4.

Change Settings

Select an optimal setting for Super IO device.

For serial port 2:

- Auto
- IO=2F8h, IRQ=3;
- IO=3F8h, IRQ=3, 4, 5, 6, 7, 9, 10, 11, 12;
- IO=2F8h, IRQ=3, 4, 5, 6, 7, 9, 10, 11, 12;
- IO=3E8h, IRQ=3, 4, 5, 6, 7, 9, 10, 11, 12;
- IO=2E8h, IRQ=3, 4, 5, 6, 7, 9, 10, 11, 12;

For serial port 3:

- Auto
- IO=3E8h, IRQ=7;
- IO=3E8h, IRQ=3, 4, 5, 6, 7, 9, 10, 11, 12;
- IO=2E8h, IRQ=3, 4, 5, 6, 7, 9, 10, 11, 12;
- IO=2F0h, IRQ=3, 4, 5, 6, 7, 9, 10, 11, 12;
- IO=2E0h, IRQ=3, 4, 5, 6, 7, 9, 10, 11, 12;

For serial port 4:

- Auto
- IO=2E8h, IRQ=7;
- IO=3E8h, IRQ=3, 4, 5, 6, 7, 9, 10, 11, 12;
- IO=2E8h, IRQ=3, 4, 5, 6, 7, 9, 10, 11, 12;
- IO=2F0h, IRQ=3, 4, 5, 6, 7, 9, 10, 11, 12;
- IO=2E0h, IRQ=3, 4, 5, 6, 7, 9, 10, 11, 12;

- **Hardware Monitor**

This screen monitors hardware health status.

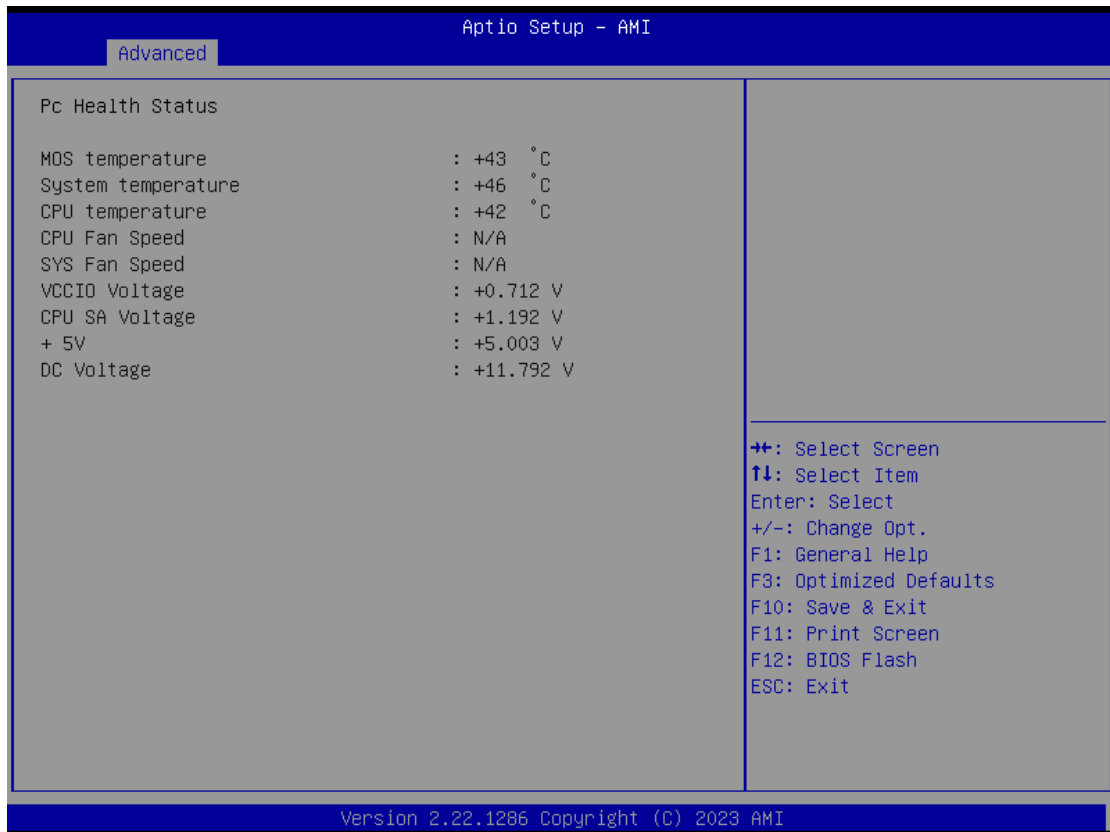

This screen displays the temperature of system and CPU, cooling fans speed in RPM and system voltages (VCCIO, CPU SA, +5V and +12V).

- **Serial Port 1 Configuration**

Select RS-232/422/485 mode for serial port 1.

- **USB Configuration**

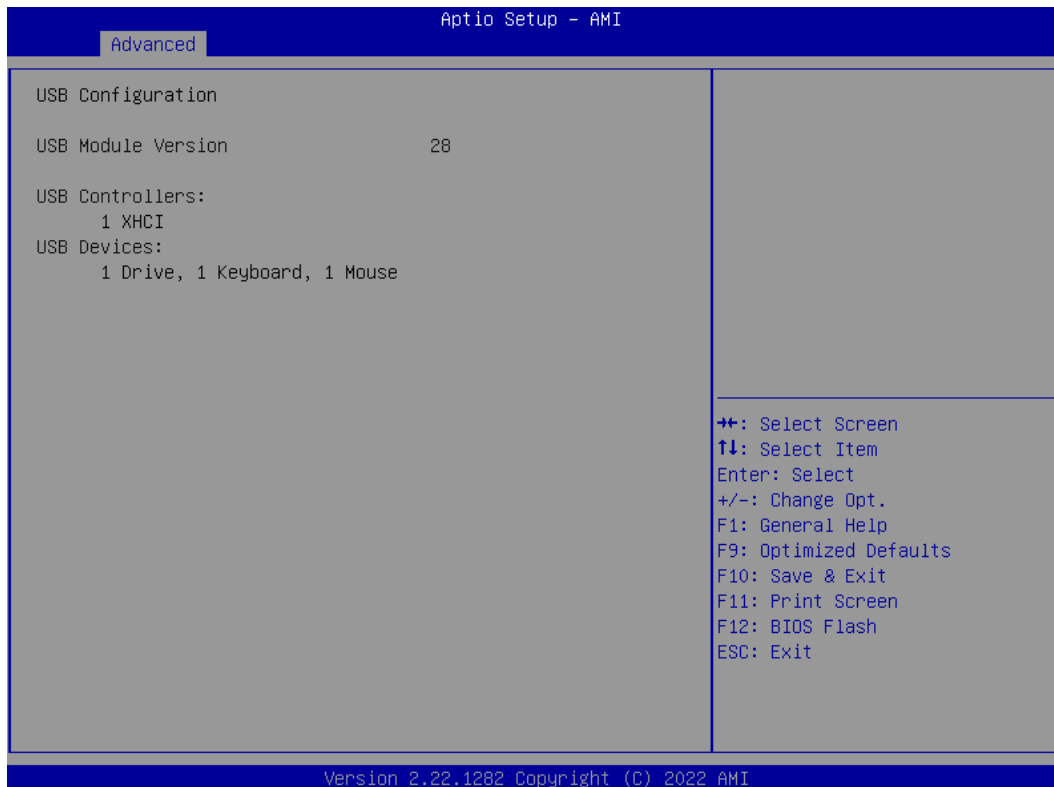
**USB Devices**

Display all detected USB devices

● **Network Stack Configuration**



Network Stack

Enable or disable UEFI Network Stack.

IPv4/IPv6 PXE Support

Enable or disable IPv4 PXE boot support. If disabled, IPv4/IPv6 PXE boot support will not be available.

IPv4/IPv6 HTTP Support

Enable or disable IPv4/IPv6 HTTP boot support. If disabled, IPv4/IPv6 HTTP boot support will not be available.

PXE boot wait time

Wait time in seconds to press <ESC> key to abort the PXE boot. Use either +/- or numeric keys to set the value.

Media detect count

Number of times the presence of media will be checked. Use either +/- or numeric keys to set the value.

USB Configuration

3.5 Chipset Menu

The Chipset menu allows users to change the advanced chipset settings. You can select any of the items in the left frame of the screen to go to the sub menus:

- ▶ System Agent (SA) Configuration
If there are any relevant settings that need to be changed, please contact Axiomtek.
- ▶ PCH-IO Configuration
- ▶ Onboard Device
- ▶ RTD213x EDP-LVDS (default setting by LCD source)

For items marked with “▶”, please press <Enter> for more options.

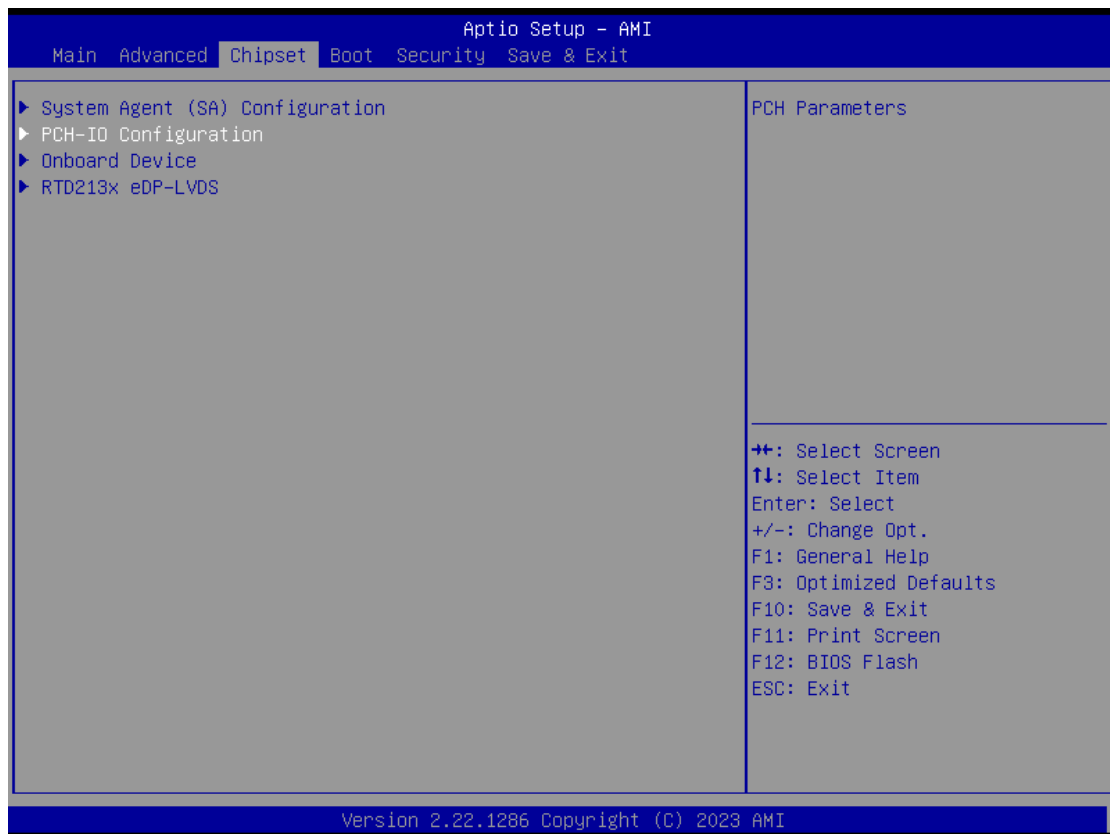

- **PCH-IO Configuration**

This screen allows you to set PCH parameters.

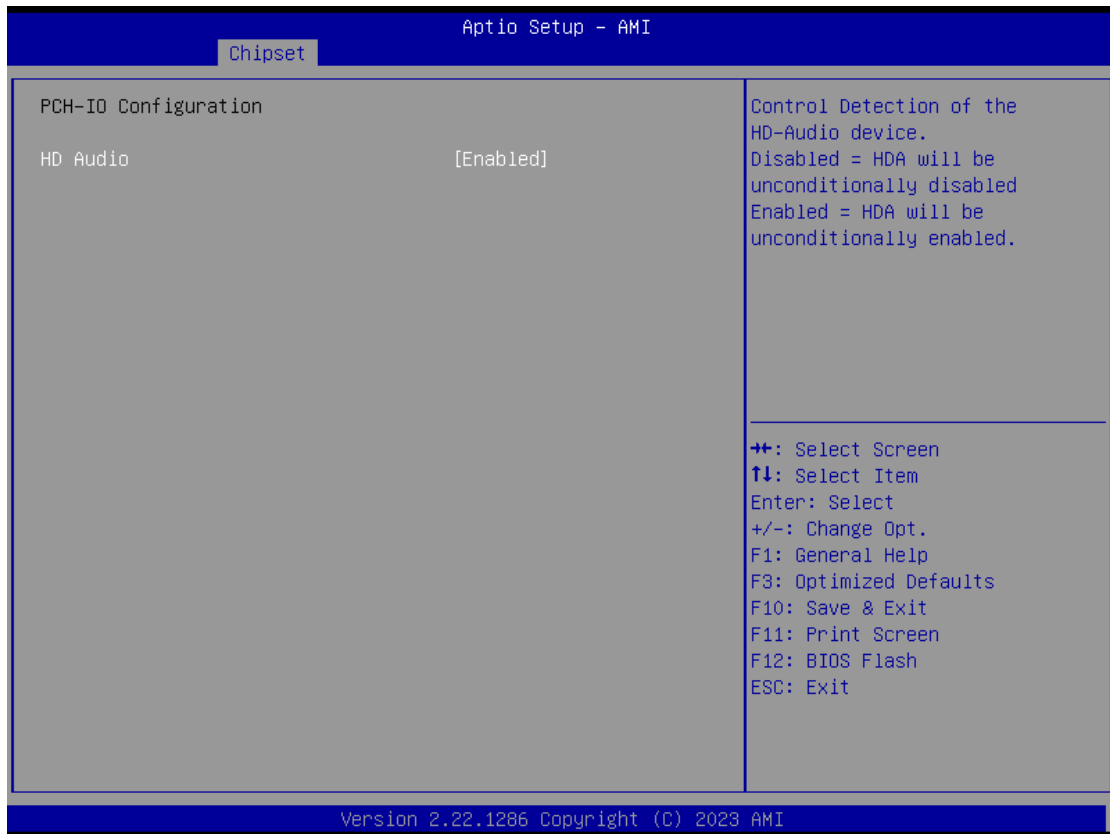

HD Audio

Control detection of the HD Audio device.

- Disabled: HDA will be unconditionally disabled.
- Enabled: HDA will be unconditionally enabled.
- Auto: HDA will be enabled if present, disabled otherwise.

- Onboard Device

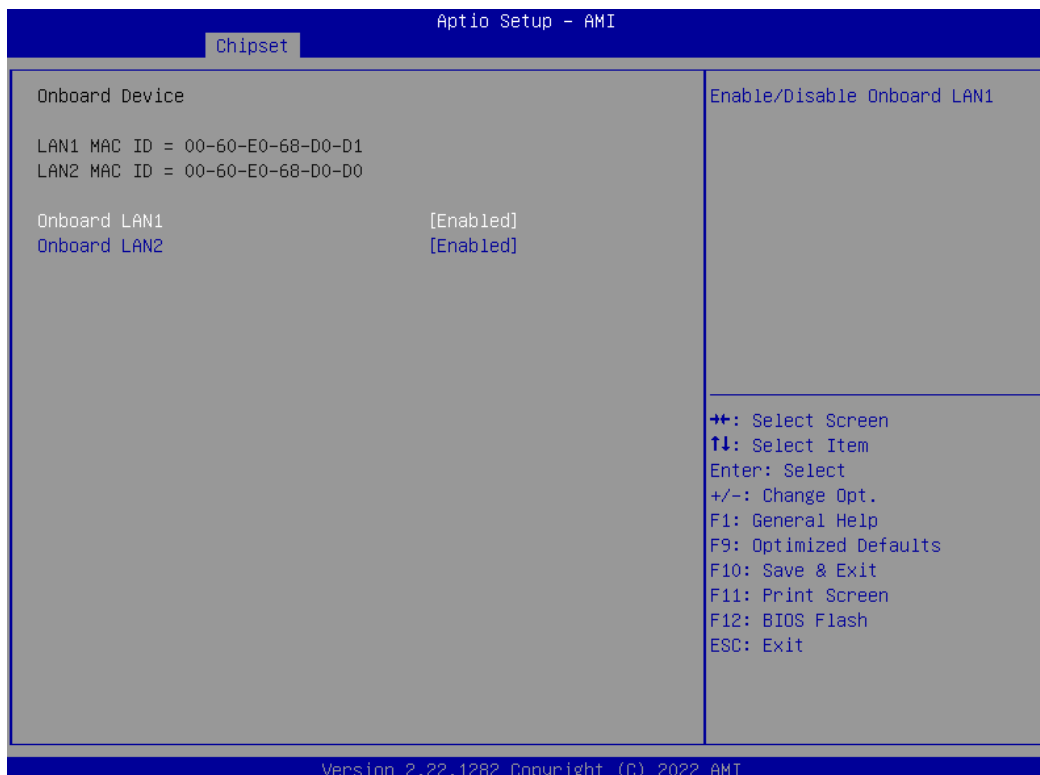

Onboard LAN 1/2

Enable or disable onboard LAN 1/2.

3.6 Boot Menu

The Boot menu allows users to change boot options of the system.

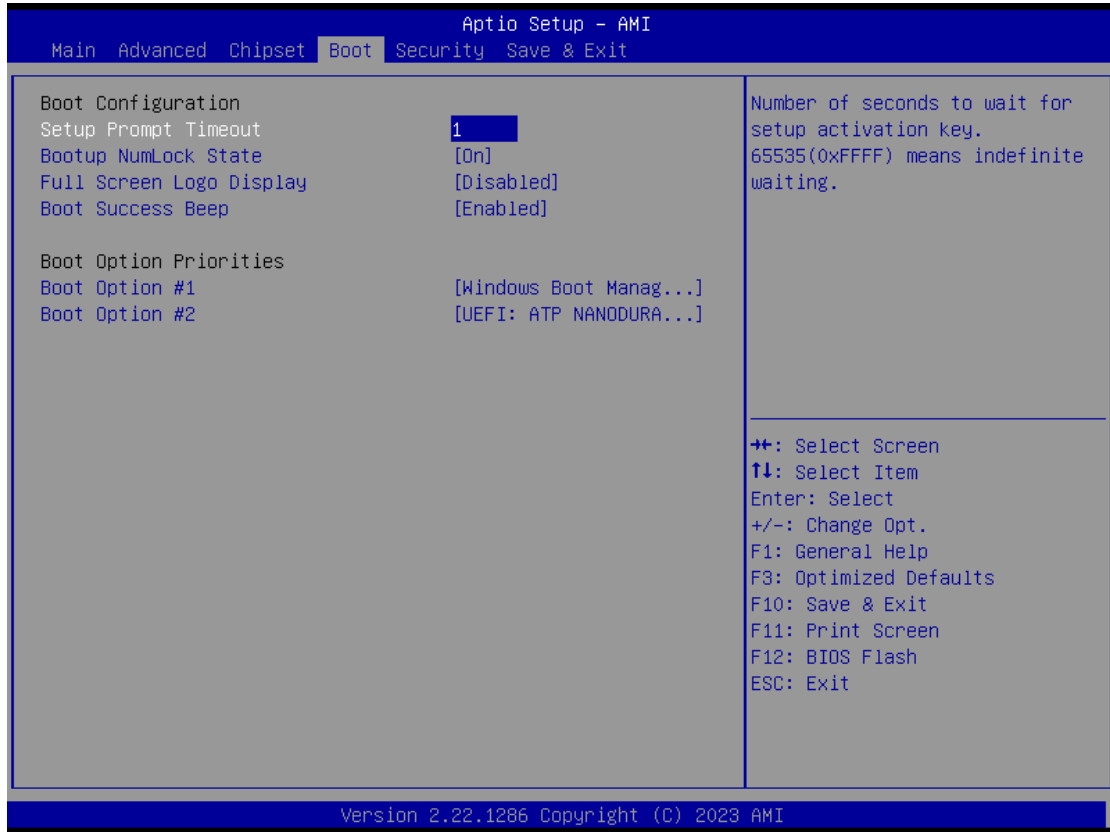

Setup Prompt Timeout

Number of seconds to wait for setup activation key. 65535(0xFFFF) means indefinite waiting.

Bootup NumLock State

Select the keyboard Numlock state.

Full Screen Logo Display.

Enable or disable full screen logo display feature.

Boot Success Beep

Enable or disable beep sound after successful boot.

Boot Option Priorities

These are settings for boot priority. Specify the boot device priority sequence from the available devices.

3.7 Security Menu

The Security menu allows users to change the security settings for the system.

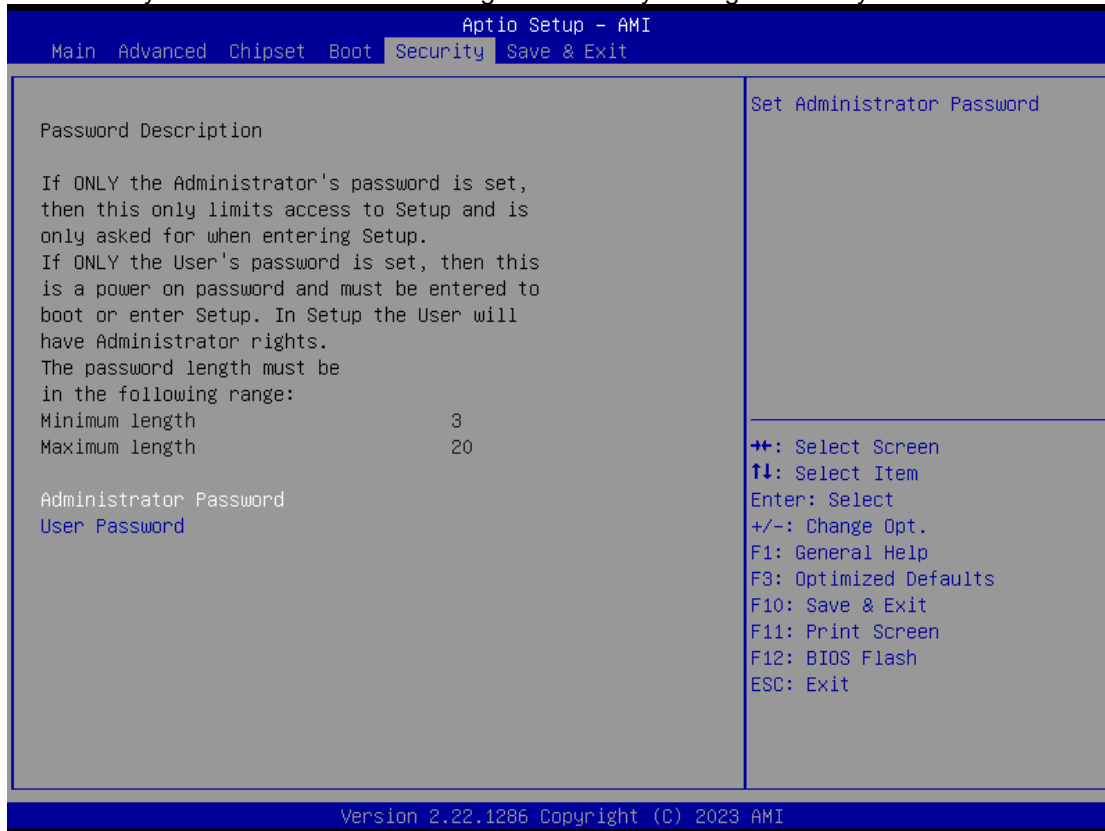

Administrator Password

Set administrator password.

User Password

Set user password.

3.8 Save & Exit Menu

The Save & Exit menu allows users to load your system configuration with optimal or fail-safe default values.

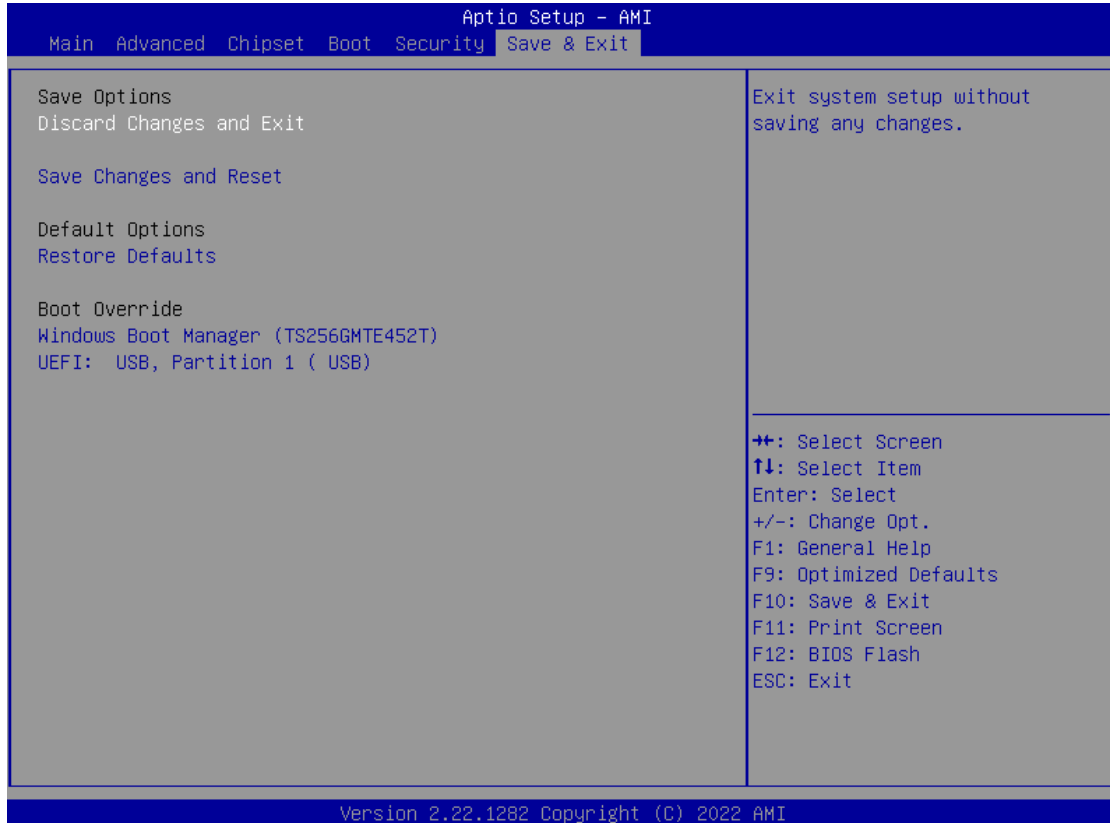

- **Discard Changes and Exit**
Exit system setup without saving any changes.
- **Save Changes and Reset**
Reset the system after saving the changes.
- **Restore Defaults**
Restore or load default values for all the setup options.
- **Boot Override**
Select a drive to immediately boot that device regardless of the current boot order.

Section 4

Drivers Installation

4.1 Operating System

GOT321B-ADL-WCD is compatible with operating systems Windows 11 and Windows 11 IoT Enterprise. To facilitate the installation of system drivers, please carefully read the instructions in this section before any of such installation.

4.1.1 Driver download

Please download the GOT321B-ADL-WCD driver from Axiomtek's official website

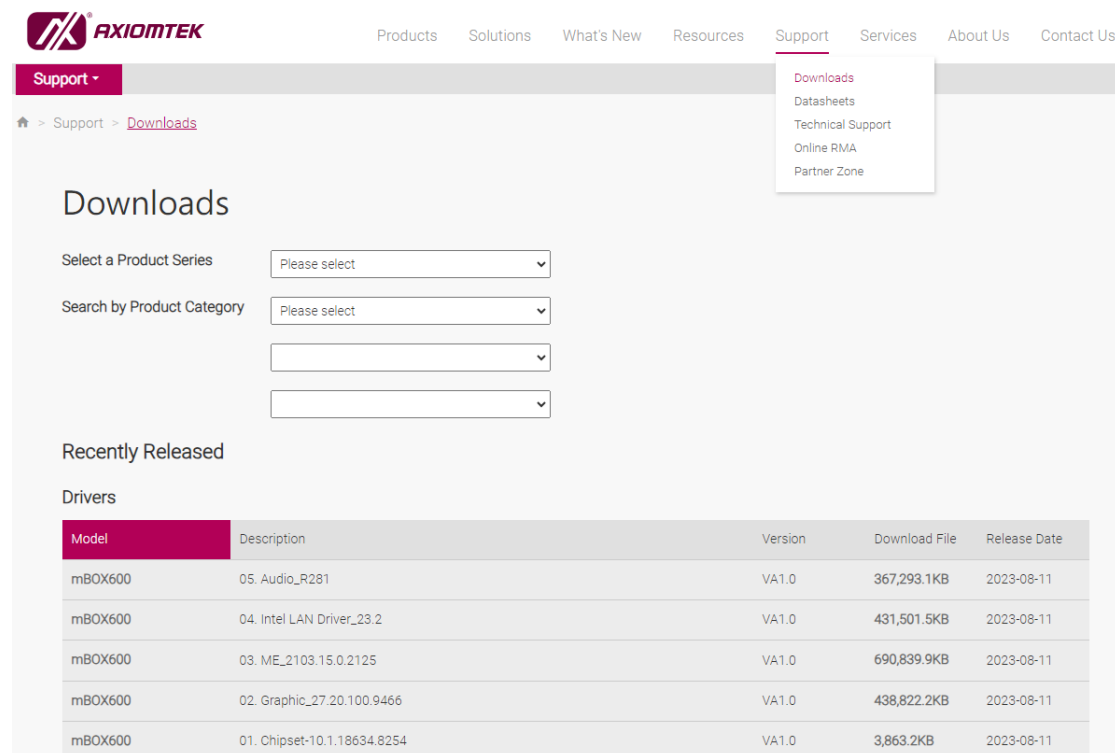

AXIOMTEK Products Solutions What's New Resources Support Services About Us Contact Us

Support ▾

Downloads
Datasheets
Technical Support
Online RMA
Partner Zone

Home > Support > Downloads

Downloads

Select a Product Series

Search by Product Category

Recently Released

Drivers

Model	Description	Version	Download File	Release Date
mBOX600	05. Audio_R281	VA1.0	367,293.1KB	2023-08-11
mBOX600	04. Intel LAN Driver_23.2	VA1.0	431,501.5KB	2023-08-11
mBOX600	03. ME_2103.15.0.2125	VA1.0	690,839.9KB	2023-08-11
mBOX600	02. Graphic_27.20.100.9466	VA1.0	438,822.2KB	2023-08-11
mBOX600	01. Chipset-10.1.18634.8254	VA1.0	3,863.2KB	2023-08-11

4.2 Touch Screen

The GOT321B-ADL-WCD adopts projected capacitive multi-touch screen of which specifications are listed below. Users should install the touch driver for calibration to allow the user to operate the touch panel using multi-finger touch functions on the Windows 11 and Windows11 IoT Enterprise environments.

Table 4-1 Touch screen specifications

Touch Screen	Projected capacitive multi-touch
Touch Screen Controller	TPK_USB Touch Screen Controller IC
Communications	USB interface
Power Supply	5V
Power Consumption	<100mA +10mA
Input Method	Finger or Cap.Stylus
Resolution	25ppi (Min.)_ Note: Based on the Windows definition, ppi (pixels per inch)
Windows USB Driver	Non-Driver
Calibration	Non-Calibration

Appendix A

TPM BitLocker Settings

1. Setup BitLocker Drive Encryption main storage. Press <Win + R> and type "Control Panel", then select BitLocker Drive Encryption.

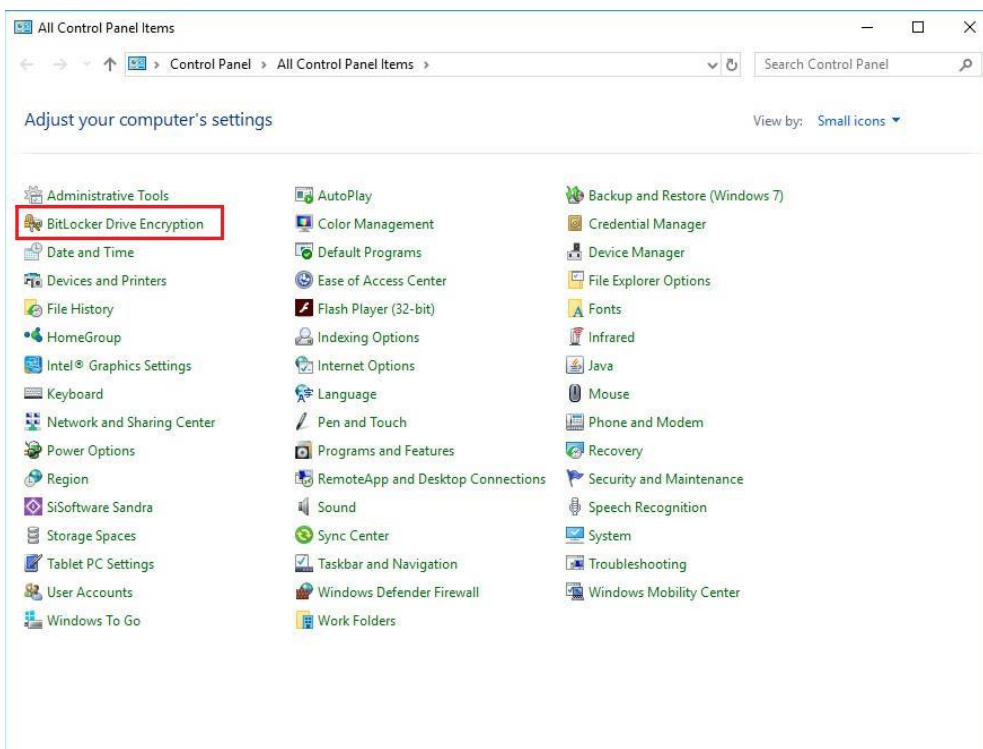
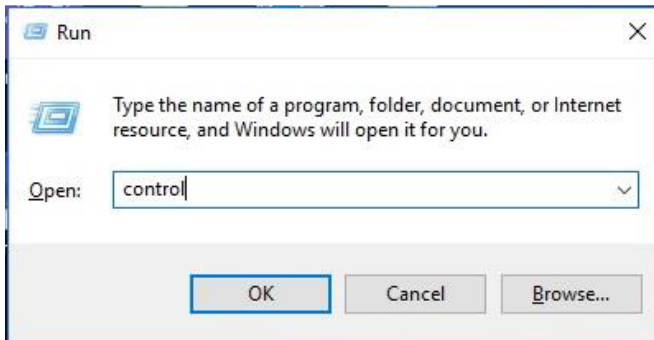

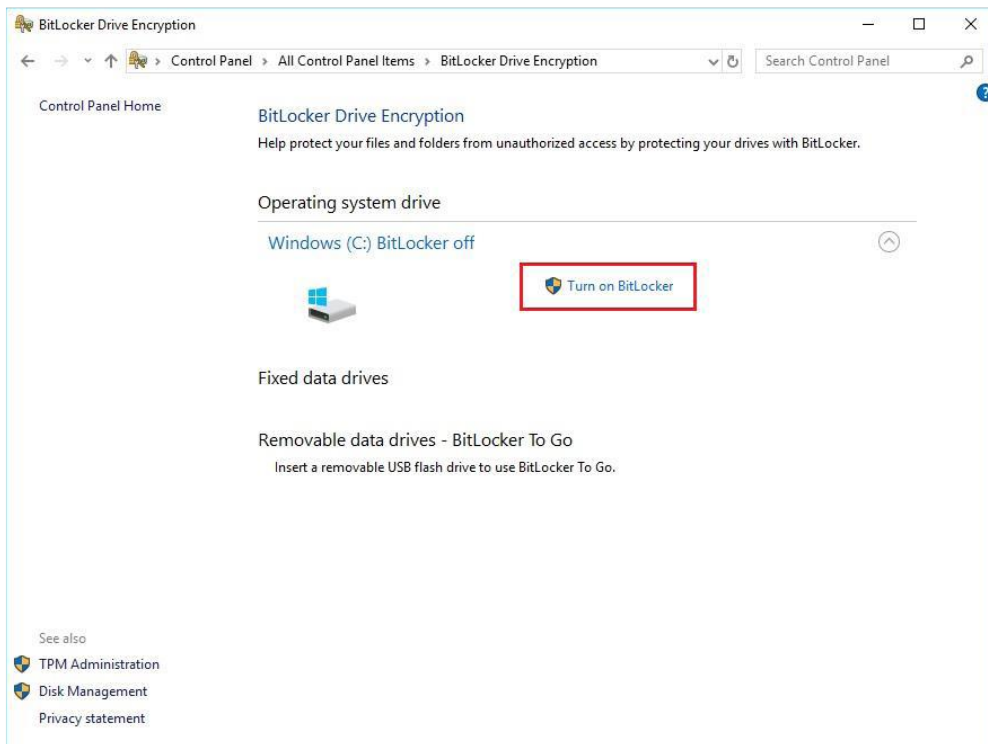

2. Insert an external storage device, for example USB Storage. Back up BitLocker recovery key in a new file and save it to the USB Storage.

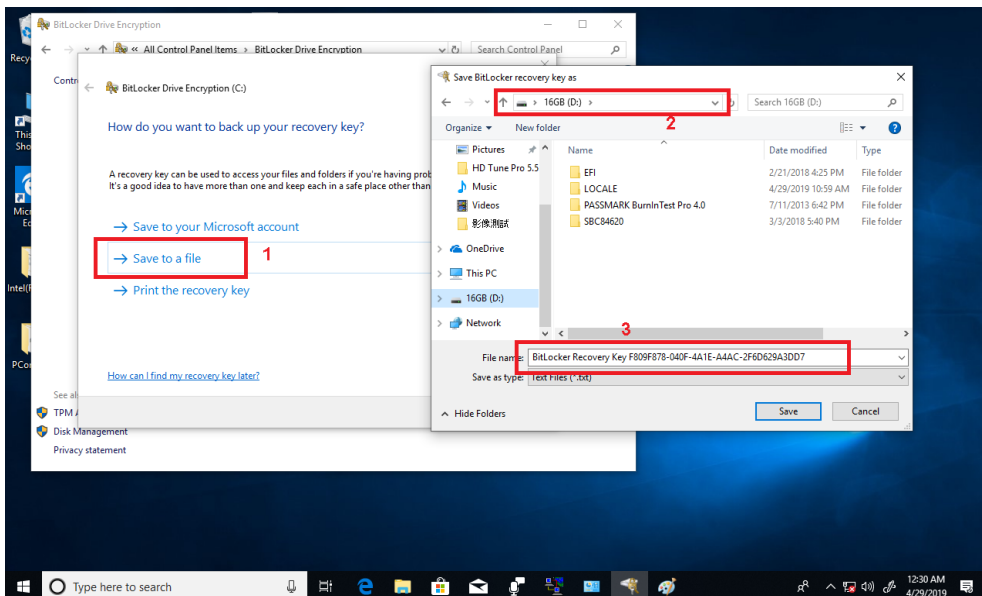

3. Please follow the steps below to encrypt your storage device:

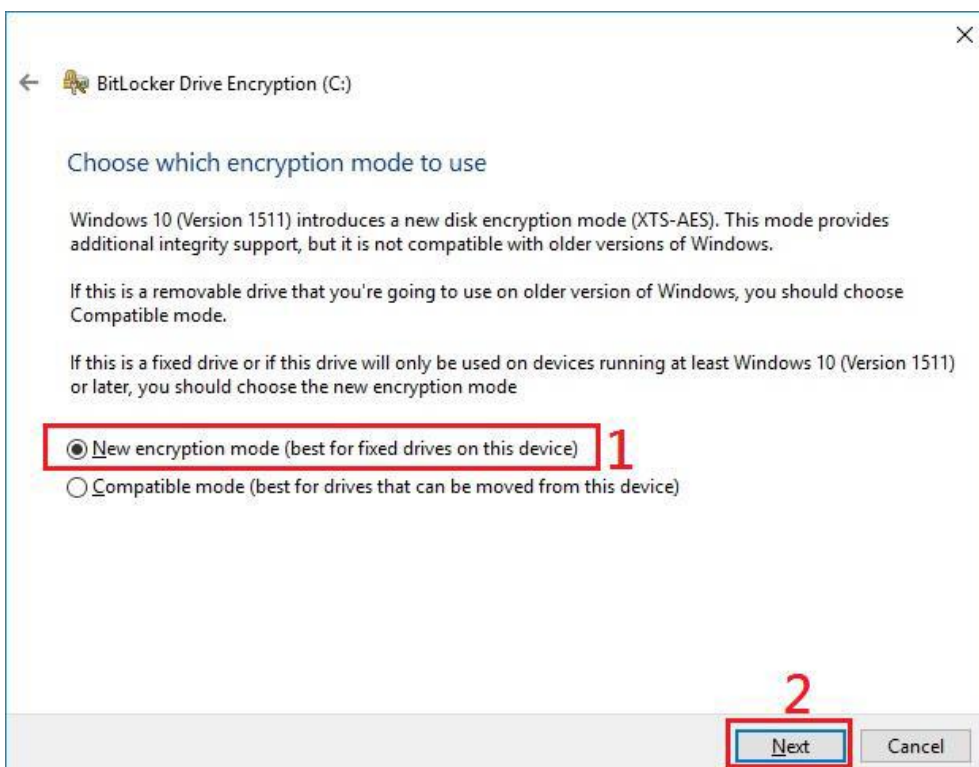
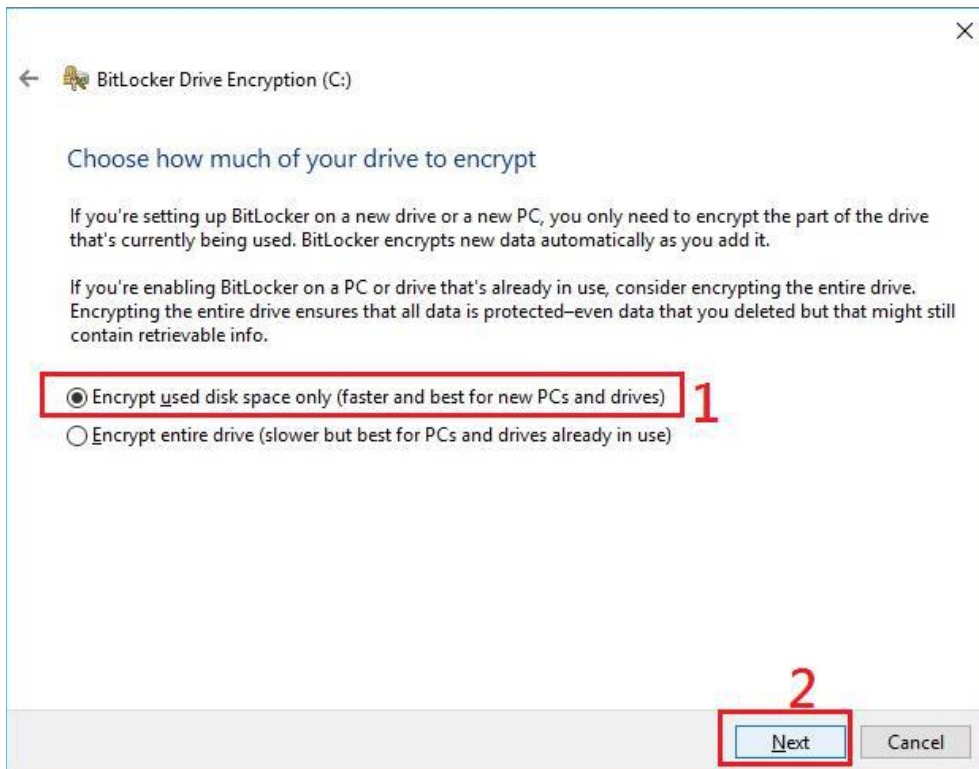

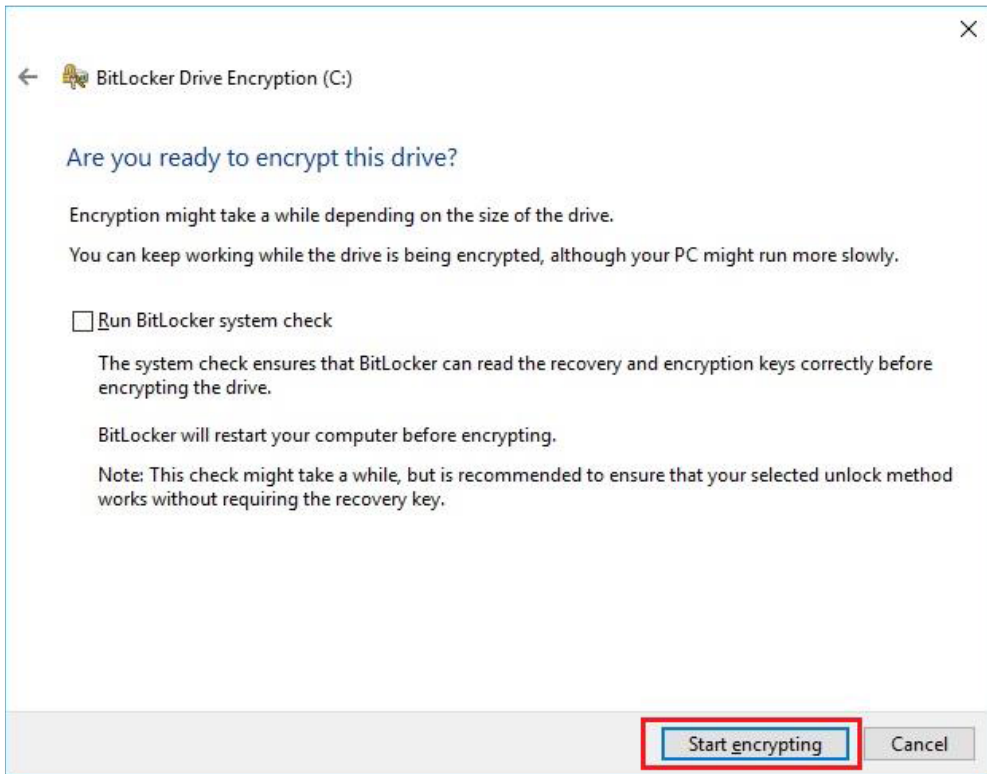

Now, the system prompts that the operating system drive encryption is in progress, and the encryption progress is checked.

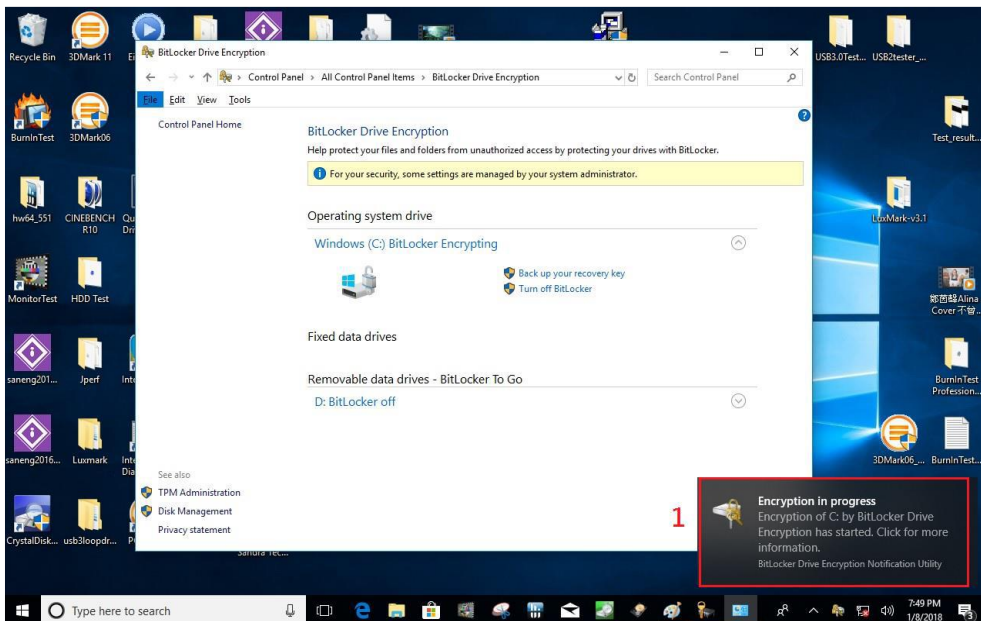

Select and click the icon in the lower right corner to complete the encryption.

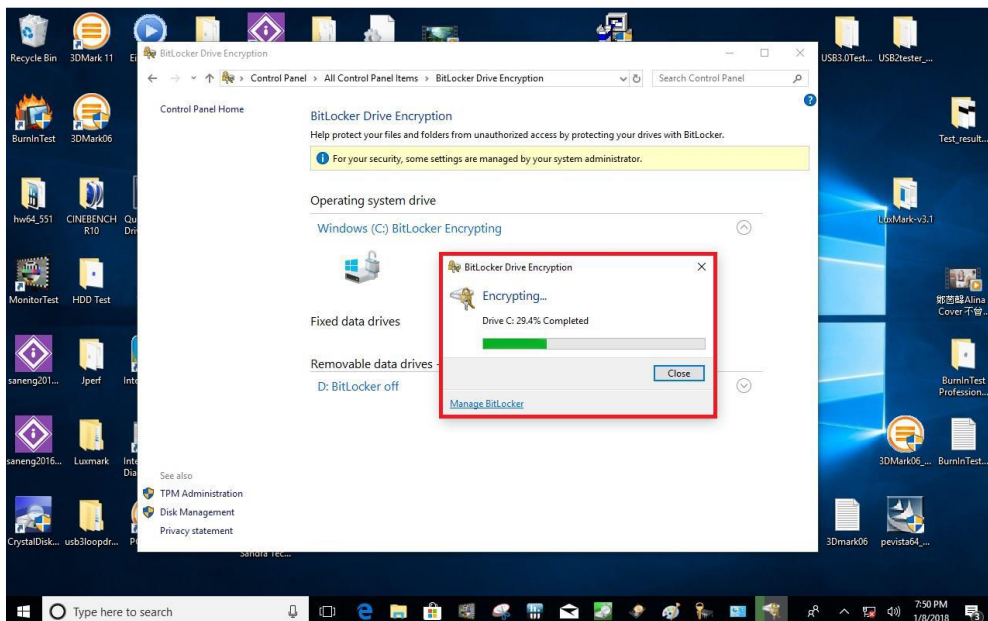
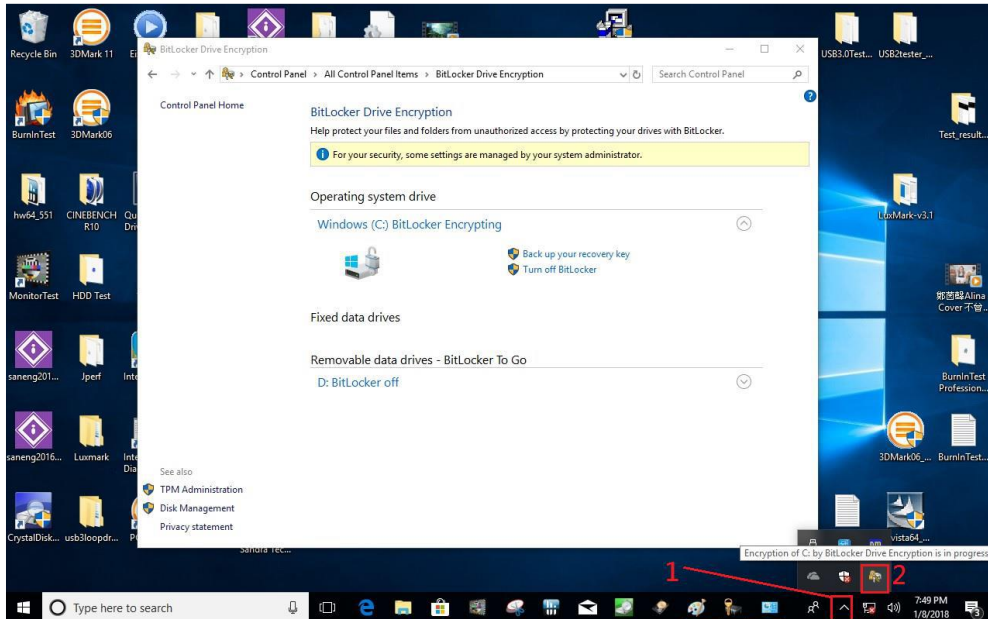

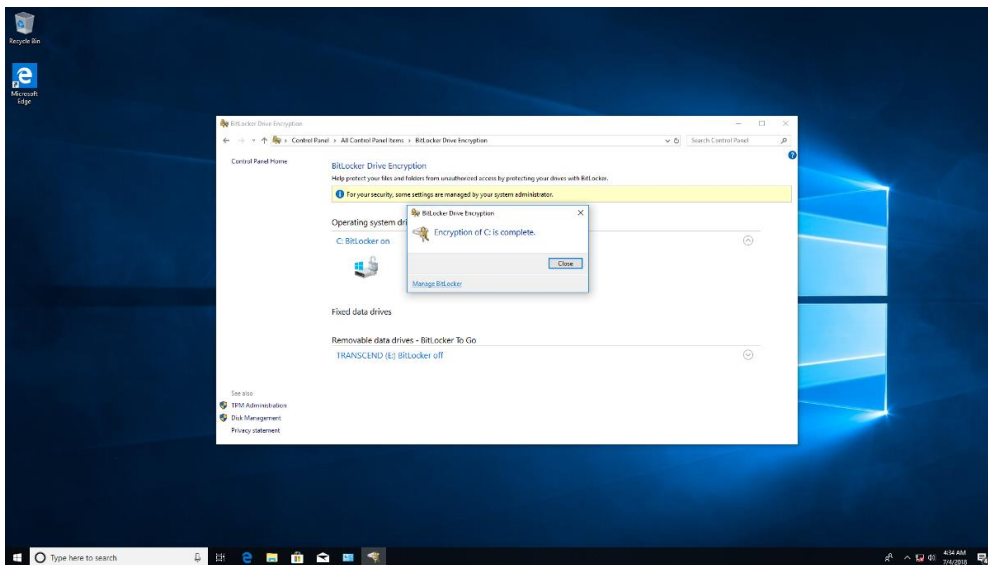

4. Confirm the completion of encryption.

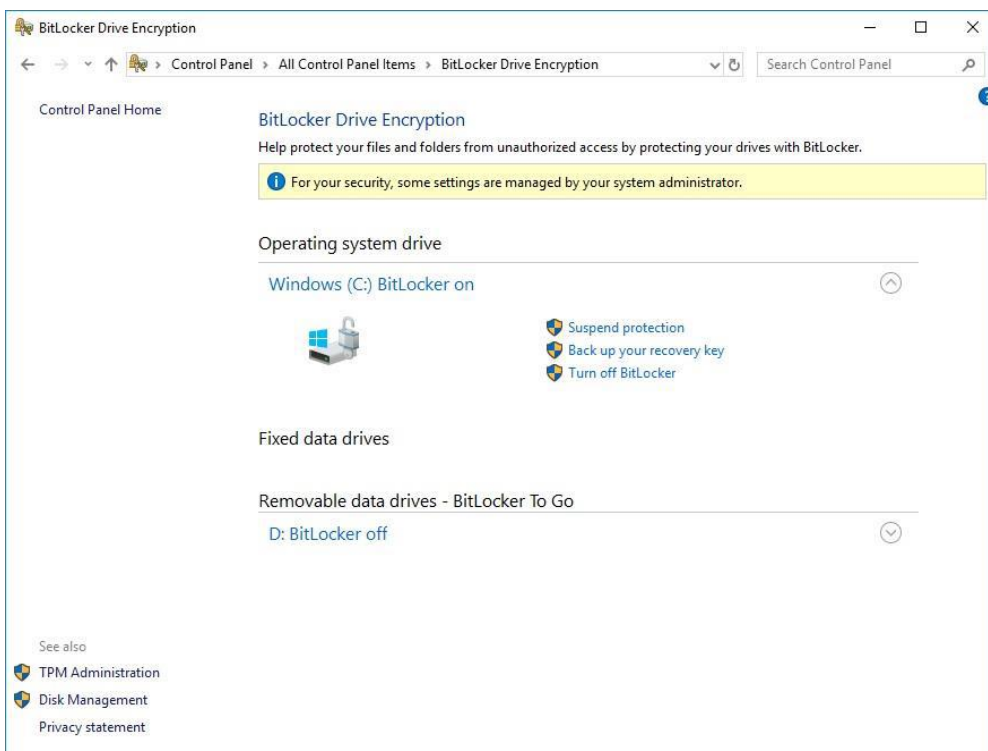

5. Disable TPM function in BIOS Setup Utility.

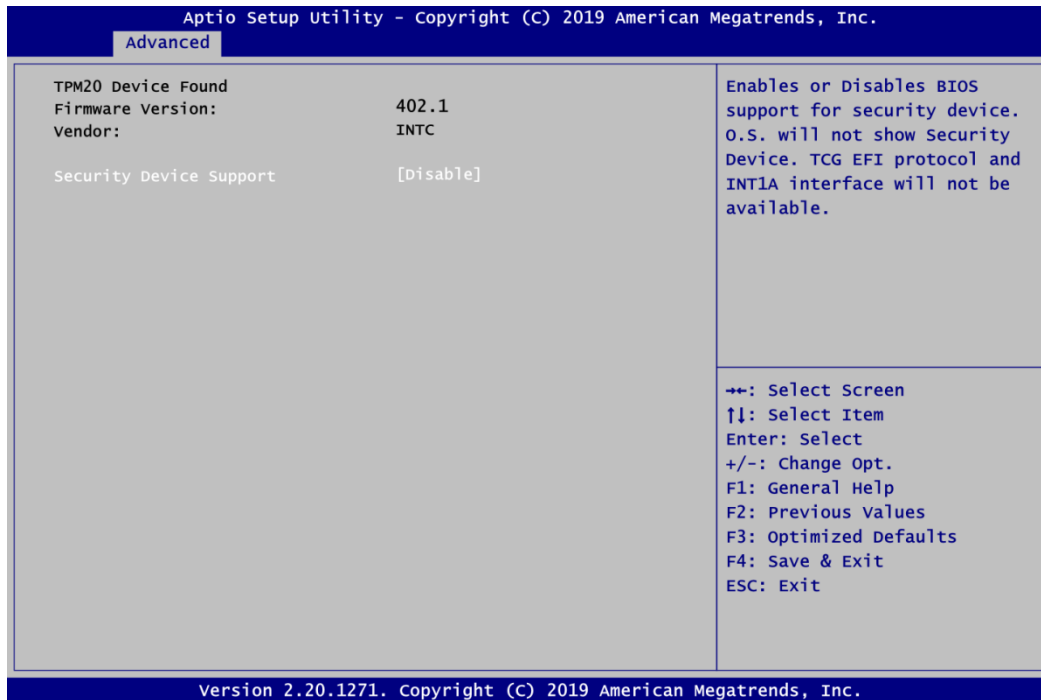

6. When the system is powered on and you see the following screen, it means the TPM module function is working fine. Note that BitLocker cannot be executed if your system does not have TPM function.

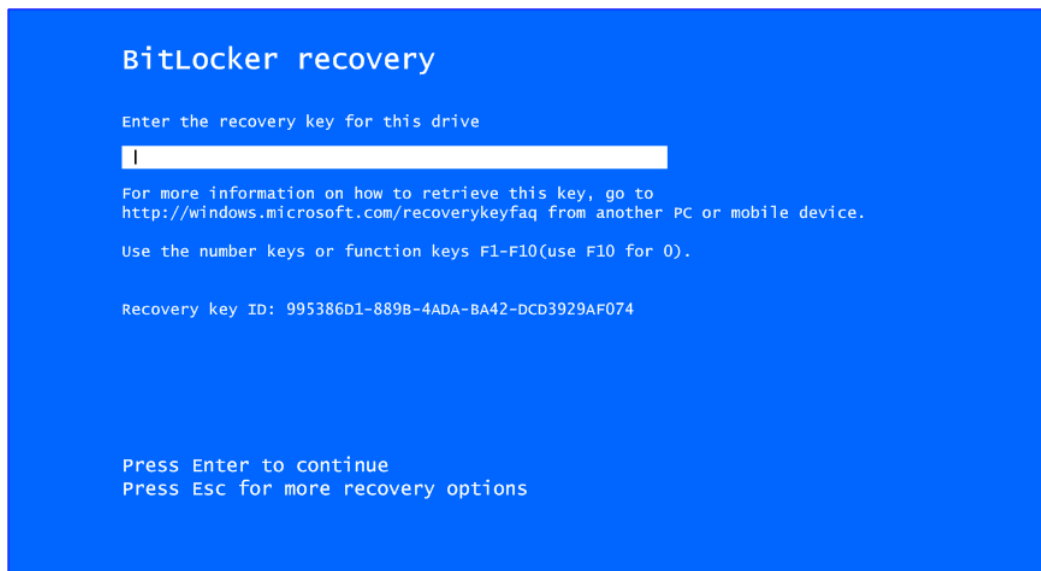



NOTE: System with no TPM function support is as below:

1. **TPM information is not found in Device Manager.**



2. **When trying to turn on BitLocker, the following error message shows up.**

