

USER'S MANUAL

IMB540

**Intel® Socket 1700 Core™ i9/i7/ i5/ i3
/Pentium®/ Celeron® and Xeon® E
Processors ATX Industrial
Motherboard**

User's Manual



www.axiomtek.com

Disclaimers

This manual has been carefully checked and is believed to contain accurate information. Axiomtek Co., Ltd. assumes no responsibility for any infringements of patents or any third party's rights, and any liability arising from such use.

Axiomtek does not warrant or assume any legal liability or responsibility for the accuracy, completeness or usefulness of any information in this document. Axiomtek does not make any commitment to update the information in this manual.

Axiomtek reserves the right to change or revise this document and/or product at any time without notice.

No part of this document may be reproduced, stored in a retrieval system, or transmitted, in any form or by any means, electronic, mechanical, photocopying, recording, or otherwise, without the prior written permission of Axiomtek Co., Ltd.

CAUTION

Wrong type of batteries may cause explosion. It is recommended that users only replace with the same or equivalent type of batteries as suggested by the manufacturer once properly disposing of any used ones.

©Copyright 2023 Axiomtek Co., Ltd.

All Rights Reserved

October 2023, Version A2

Printed in Taiwan

ESD Precautions

Computer boards have integrated circuits sensitive to static electricity. To prevent chipsets from electrostatic discharge damage, please take care of the following jobs with precautions:

- Do not remove boards or integrated circuits from their anti-static packaging until you are ready to install them.
- Before holding the board or integrated circuit, touch an unpainted portion of the system unit chassis for a few seconds. To discharge static electricity from your body.
- Wear a grounding wrist strap, available from most electronic component stores, when handling boards and components.

Trademarks Acknowledgments

Axiomtek is a trademark of Axiomtek Co., Ltd.

Intel® and Celeron® are trademarks of Intel Corporation.

Windows® is a trademark of Microsoft Corporation.

AMI is a trademark of American Megatrend Inc.

IBM, PC/AT, PS/2, and VGA are trademarks of International Business Machines Corporation.

Other brand names and trademarks are the properties and registered brands of their respective owners.

Table of Contents

Disclaimers	ii
ESD Precautions.....	iii
Section 1 Introduction.....	1
1.1 Features.....	2
1.2 Specifications.....	2
1.3 Packing list.....	4
Section 2 Board and Pin Assignments.....	5
2.1 Board Layout.....	5
2.2 Block Diagram.....	6
2.3 Jumper Settings	7
2.3.1 PCIe x16 slot bifurcation (JP1 / JP6)	8
2.3.2 AT/ATX Mode Select (JP3).....	8
2.3.3 Clear CMOS (SW1).....	8
2.3.4 COM1 Connector (CN1).....	10
2.3.5 DisplayPort++ and HDMI Connector (CN2)	10
2.3.6 VGA and DVI-D Connector (CN3).....	11
2.3.7 Audio Jack (CN4)	11
2.3.8 LAN and USB 3.2 Connectors (CN5 and CN6)	12
2.3.9 GPIO Header (CN7)	13
2.3.10 Internal Keyboard Connector (CN8).....	13
2.3.11 Internal Mouse Connector (CN9).....	13
2.3.12 M.2 2280 Key M NVMe SSD (CN10)	14
2.3.13 SMBus Header (CN12)	14
2.3.14 Internal USB Headers (CN13, CN15)	15
2.3.15 PCI-Express Mini Card Connector (CN16)	15
2.3.16 TPM Pin Header (CN19)	16
2.3.17 Front Panel Header (CN17)	16
2.3.18 Power Input Connectors (ATX1 and CN18)	17
2.3.19 Internal USB 3.2 Gen1 (5Gbps) Connector (CN20 and CN21)	17
2.3.20 COM Headers (COM3, COM4, COM5, COM6)	18
2.3.21 Fan Connectors (FAN1, FAN2, FAN3)	18
2.3.22 PCI-Express x4 Slots (PCIe2, PCIe3, PCIe5).....	19
2.3.23 SATA 3.0 Connectors (SATA1 , SATA2).....	20
Section 3 Hardware Description	21
3.1 Microprocessors.....	21
3.2 BIOS.....	21
3.3 System Memory	21

Section 4	AMI BIOS Setup Utility	23
4.1	Starting.....	23
4.2	Navigation Keys	23
4.3	Main Menu	25
4.4	Advanced Menu	26
4.5	Chipset Menu	39
4.6	Security Menu	47
4.7	Boot Menu.....	48
4.8	Save & Exit Menu.....	49
Appendix A	TPM Module Installation.....	51
Appendix B	iAMT Settings	55
	Entering Management Engine BIOS Extension (MEBx)	55
	Set and Change Password	55
	iAMT Settings.....	56
	iAMT Web Console	58
Appendix C	Digital I/O	61
	Digital I/O Software Programming.....	61

This page is intentionally left blank.

Section 1

Introduction

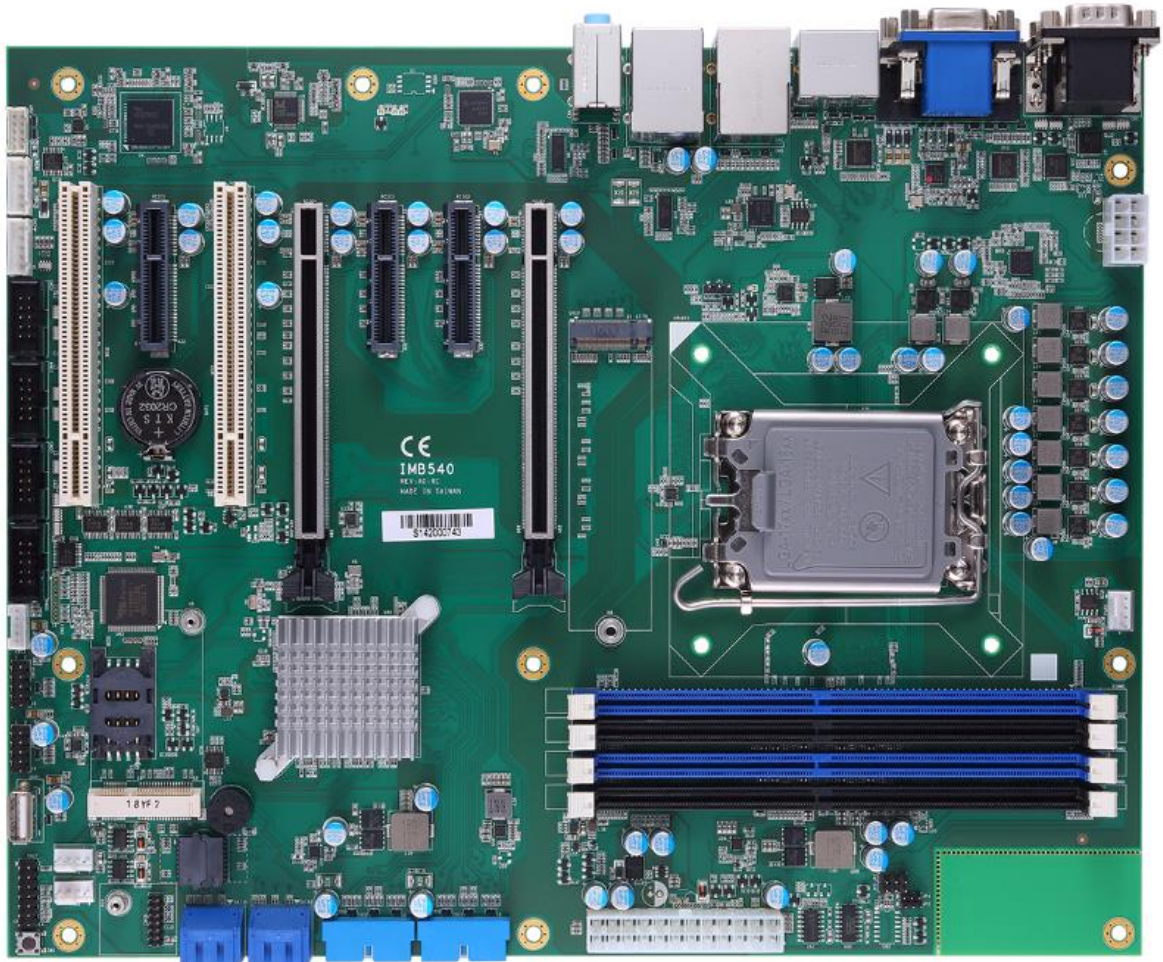

The IMB540 is an advanced ATX industrial motherboard based on the 12th Generation Intel® Core™ i9 / i7 / i5 / i3 / Pentium®, Celeron® processors (Alder lake S) in an LGA1700 socket and comes with an Intel® R680E chipset. Specially designed for optimal computing and visual performance, the IMB540 motherboard is an ideal solution for major industry applications ranging from financial modeling to designing complex buildings and vehicles. With its built-in Intel® HD Graphics GFX, this industrial grade motherboard delivers superb 3D visual performance and supports triple display through DisplayPort++, DVI-D, HDMI and VGA ports to meet professional-grade CAD and media/entertainment needs.

In addition, the IMB540 supports Intel® Turbo Boost 2.0 technology, Intel® Hyper-Threading technology, Intel® UHD Graphics with DX12, 128GB DDR4-3200 ECC/non-ECC un-buffered Long-DIMM, and 2 PCI-Express 4.0 x16 slots. It also features Intel® Active Management Technology 12 (iAMT), SATA RAID, as well as PCI Express expansion interfaces, making it specifically suited for applications with added security features.

1.1 Features

- LGA1700 socket 12th Generation Intel® Core™ i9 / i7/ i5/ i3/ Pentium®, Celeron® processors (Alder lake S) up to 125W
- 4 x 288-pin DDR4-3200 ECC/non-ECC un-buffered Long-DIMM with maximum memory capacity up to 128GB (max. 32GB per slot)
- DVI-D, HDMI, Displayport++ and VGA with four-view support
- 4 x SATA-600 w/ RAID 0/1/5/10
- 4 x USB3.2 Gen2x1 (10Gbps), 2 x Dual USB 3.2 Gen1x1(5Gbps) and 4 x USB 2.0 ports and 1 x USB 2.0 with 180D type A

1.2 Specifications

- **CPU**
- LGA1700 Socket 12th Generation Intel® Core™ i9 / i7/ i5/ i3/ Pentium®, Celeron® processors (Alder lake S) up to 125W

Model	Core	Therad	TDP
i9-12900K	16	24	125W
i9-12900E	16	24	65W
i9-12900TE	16	24	35W
i7-12700E	12	20	65W
i7-12700TE	12	20	35W
i5-12500E	6	12	65W
i5-12500TE	6	12	35W
i3-12100E	4	8	60W
i3-12100TE	4	8	35W
G6900E	2	2	46W
G6900TE	2	2	35W

- **Chipset**
 - Intel® R680E
- **BIOS**
 - AMI BIOS
- **System Memory**
 - 4 x 288-pin ECC/non-ECC un-buffered Long-DIMM sockets
 - Maximum 128GB DDR4 memory (max. 32GB per slot)
 - Supports DDR4-3200Mhz
- **Onboard Multi I/O**
 - 1 x PS/2 keyboard (internal box headers)
 - 1 x PS/2 mouse (internal box headers)
 - 1 x SMBus
 - Four serial ports:
 - 4 x RS-232 (internal box headers).
 - 2 x RS-232/422/485 (rear I/O)

- **USB Interface**
 - 4 x USB3.2 Gen2x1 (10Gbps) ports.(rear I/O)
 - 2 x Dual USB 3.2 Gen1 (5Gbps) ports. (internal,box header)
 - 4 x USB 2.0 ports. (internal,pin header)
 - 1 x USB 2.0 ports. (internal x 180D type A)
- **Ethernet**
 - LAN1: 2500/1000/100/10Mbps Gigabit/Fast Ethernet supports Wake-on-LAN, PXE Boot ROM,TSN,vPRO® with Intel® i225LM
 - LAN2: 1000/100/10Mbps Gigabit/Fast Ethernet supports Wake-on-LAN, PXE Boot ROM with Intel® i211AT
- **Serial ATA**
 - 4 x SATAIII with RAID 0/1/5/10
- **Audio**
 - Realtek ALC888 HDA Codec
 - Supports MIC-in/line-in/line-out
- **Display**
 - 1 x 15-pin D-Sub as VGA connector. Resolution max. up to 1920x1200 @60Hz
 - 1 x HDMI 1.4b with max. resolution up to 4096x2160 @24Hz
 - 1 x Displayport++ (DP 1.2) with max. resolution up to 4096 x 2304 @60Hz
 - 1 x DVI-D with resolution max. up to 1920x1200 @60Hz
- **Expansion Interface**
 - 2 x PCIe x16 slot (signal: x16 + x0 or x8 + x8)
 - 2 x PCIe x4 slot open ended (PCIe 2,3)
 - 1 x PCIe x4 slot close ended (PCIe 5 with PCIe Gen3 Signal)
 - 2 x PCI
- **Power Input**
 - 1 x ATX power input connector
 - 1 x 12V ATX power input connector for CPU Power
- **Operating Temperature**
 - 0°C ~ 60°C
- **Storage Temperature**
 - -20°C ~ 75°C
- **Form Factor**
 - 305 x 244mm



Note

All specifications and images are subject to change without notice.

1.3 Packing list

- **Bulk packing**
 - 1 x Motherboard
 - 1 x I/O bracket

- **Gift box**
 - 1 x Motherboard
 - 1 x I/O bracket

Section 2

Board and Pin Assignments

2.1 Board Layout

Top side

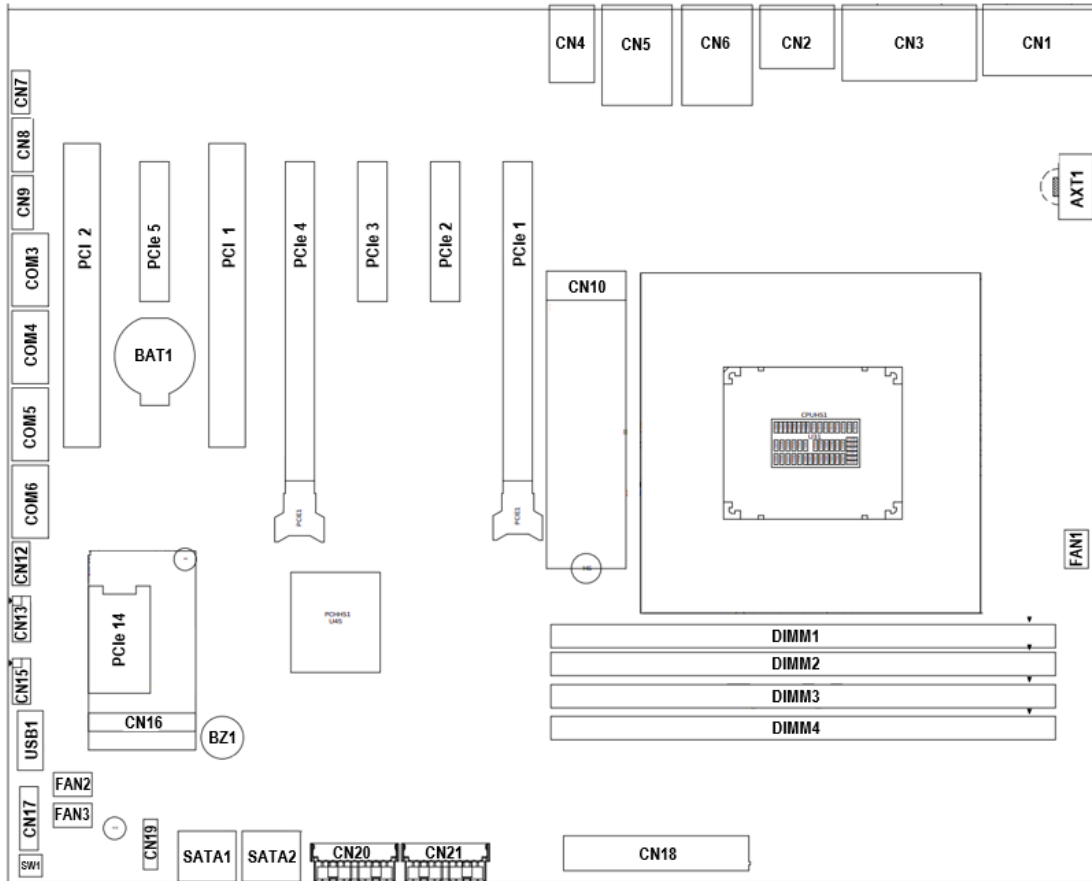

2.2 Block Diagram

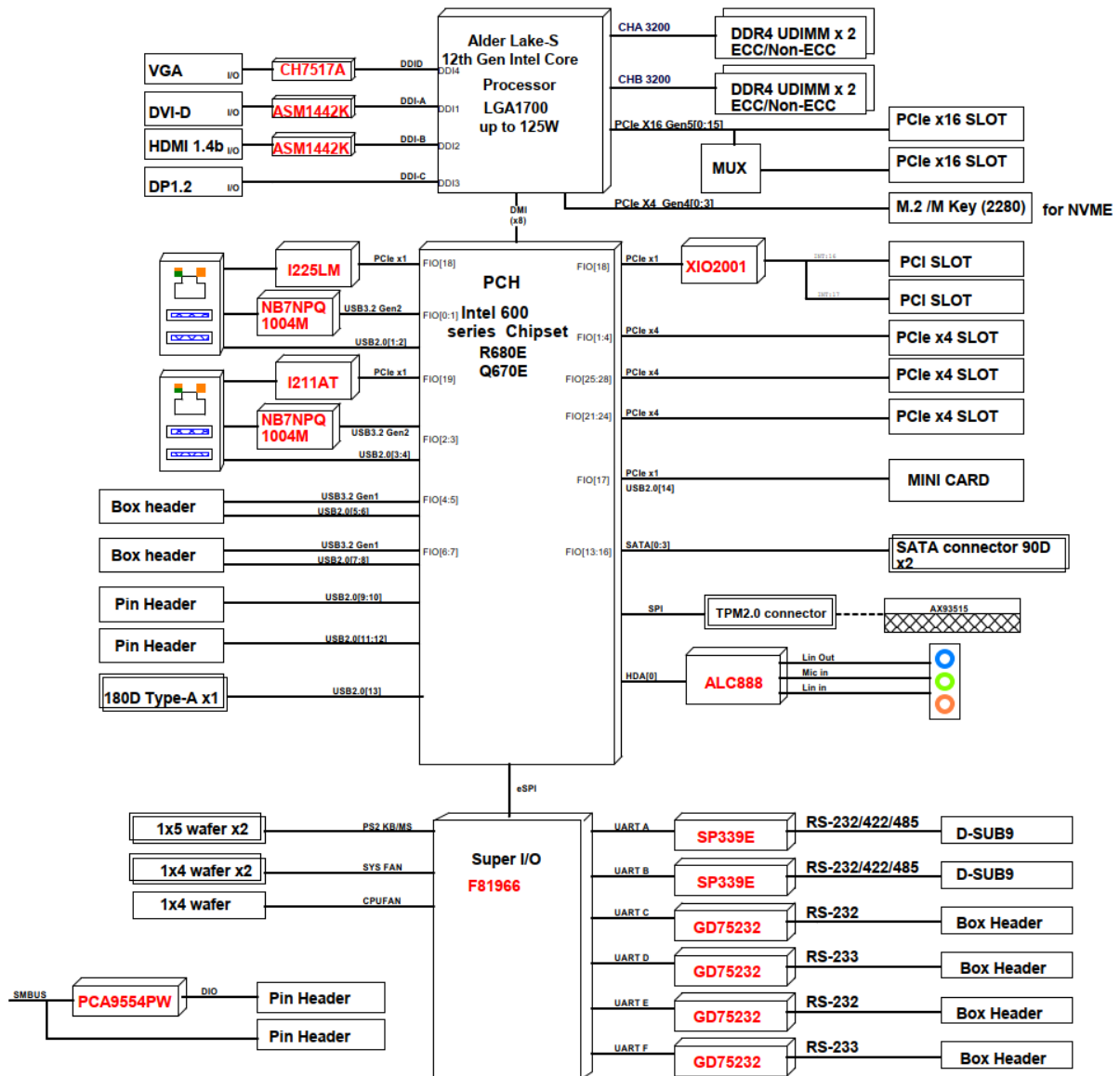

2.3 Jumper Settings

Pin description

A jumper is a small component consisting of a jumper clip and jumper pins. Install a jumper clip on two jumper pins to close the jumper pins. Remove the jumper clip from two jumper pins to open the jumper pins. The following illustration shows how to set up a jumper.

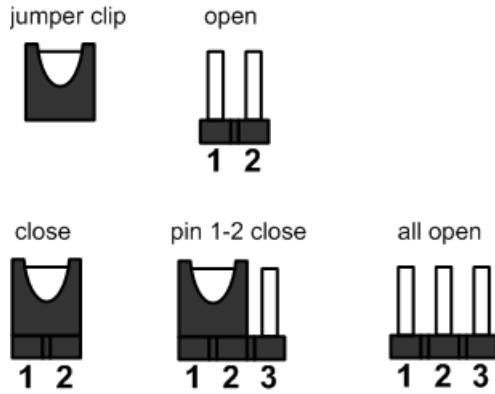

Note

To identify the first pin of a header or jumper, please refer to the following information:

- There is a thick line or a triangle near the header or jumper pin 1.

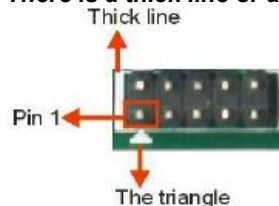

- A square pad, which you can find on the back of the motherboard, is usually used for pin 1.



Before applying power to the IMB540 series motherboard, make sure all of the jumpers are in factory default position. Below you can find a summary table of all jumpers and onboard default settings.

Jumper	Description	Setting
JP1/JP6	PCIe x16 slot Default: x16	1-2 Close
JP3	AT/ATX Power Mode Select Default: AT Mode	1-2 Close

2.3.1 PCIe x16 slot bifurcation (JP1 / JP6)

Use these jumpers (3x1-pin p=2.54mm) to set signal of PCIe x16 slot.

CN14	JP1	JP6
PCIe 1 x16 PCIe 4 x0	1-2 (Default)	1-2 (Default)
PCIe 1 x8 PCIe 4 x8	2-3	2-3



2.3.2 AT/ATX Mode Select (JP3)

This 3x1-pin p=2.54mm jumper allows you to select AT or ATX power mode.

Function	Setting
AT mode (Default)	1-2 close
ATX mode	2-3 close



2.3.3 Clear CMOS (SW1)

Pressing the tact switch can restore BIOS optimal defaults.
(The button is next to the Front Panel Header connector)

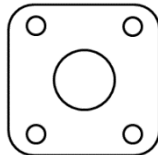

Signals go to other parts of the system through connectors. Loose or improper connection might cause problems. Make sure all connectors are properly and firmly connected. Here is a summary table showing the connectors on the motherboard.

Connector	Description
CN1	Com port Connector
CN2	DP/HDMI Connector
CN3	DVI-D/ VGA Connector
CN4	Audio Jack
CN5	GbE RJ45 + USB3.2 Gen2x1 (10Gbps) Connector
CN6	2.5 GbE RJ45 (iAMT)+ USB3.2 Gen2x1 (10Gbps) Connector
CN7	DIO Connector
CN8	Internal PS/2 KB Connector
CN9	Internal PS/2 MS Connector
CN10	M.2 Connector
CN13, CN15	Internal USB2.0 Headers
CN16	PCI Express Mini Card
CN17	Front Panel Header
CN18	24-pin Power Input Connector
CN19	TPM 2.0 Connector (Optional)
CN20,CN21	Internal USB3.2 Gen1 (5Gbps) Connector
ATX1	CPU Power Input Connector
COM3, COM4, COM5, COM6	Comport Box Header
FAN1	CPU Fan Connector
FAN2, FAN3	System Fan Connectors
PCIe1, PCIe4	PCI-Express x16 Slots
PCIe2, PCIe3, PCIe5	PCI-Express x4 Slots
PCI1,PCI2	PCI Slots
SATA1, SATA2, SATA3, SATA4	SATA III Connector

2.3.4 COM1 Connector (CN1)

This is a high rise 9-pin D-Sub connector for COM1 serial port interface. The pin assignments of RS-232/422/485 are listed in the table below.

Pin	RS-232 [1]	RS-422 [1]	RS-485 [1]
1	DCD#	TX-	485-
2	RXD	TX+	485+
3	TXD	RX+	N/C
4	DTR#	RX-	N/C
5	GND	GND	GND
6	DSR#	N/C	N/C
7	RTS#	N/C	N/C
8	CTS#	N/C	N/C
9	RI#	N/C	N/C

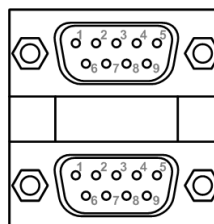

Note

[1]: Signals of COM1, COM2 can be RS-232/422/485 by BIOS setting.

2.3.5 DisplayPort++ and HDMI Connector (CN2)

CN2 is a double-deck connector comprised of an upper connector for DisplayPort++ (CN2A) and a lower connector for HDMI (CN2B).

Pin	Signal	Pin	Signal
1	LANE 0	21	DATA2
2	GND	22	GND
3	LANE 0#	23	DATA2#
4	LANE 1	24	DATA1
5	GND	25	GND
6	LANE 1#	26	DATA1#
7	LANE 2	27	DATA0
8	GND	28	GND
9	LANE 2#	29	DATA1#
10	LANE 3	30	Clock
11	GND	31	GND
12	LANE 3#	32	Clock#
13	Detect Pin	33	NC
14	GND	34	NC
15	AUX CH	35	SCL
16	GND	36	SDA
17	AUX CH#	37	GND
18	Hot Plug Detect	38	+5V POWER
19	GND	39	Hot Plug Detect
20	DP_PWR(3.3V)		

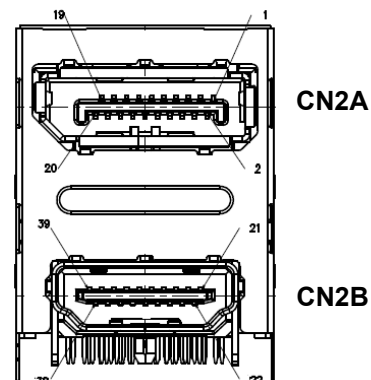

2.3.6 VGA and DVI-D Connector (CN3)

CN3 is a double-deck connector comprising a lower connector for DVI-D port and an upper connector for VGA port.

The high rise DVI-D connector provides transmission of fast and high quality video signals between a source device (graphic card) and a display device (monitor).

Pin	Signal	Pin	Signal
1	TX2-	2	TX2+
3	Ground	4	NC
5	NC	6	DVI_SPD_CLK
7	DVI_SPD DATA	8	NC
9	TX1-	10	TX1+
11	Ground	12	NC
13	NC	14	VGAVCC
15	Ground	16	HPDETECT
17	TX0-	18	TX0+
19	Ground	20	NC
21	NC	22	Ground
23	TXC+	24	TXC-

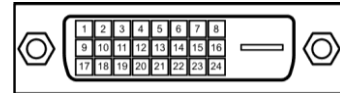

The 15-pin D-Sub connector is commonly used for VGA display.

Pin	Signal	Pin	Signal
1	Red	2	Green
3	Blue	4	NC
5	GND	6	GND
7	GND	8	GND
9	VCC	10	GND
11	NC	12	DDC DATA
13	Horizontal Sync	14	Vertical Sync
15	DDC CLK		

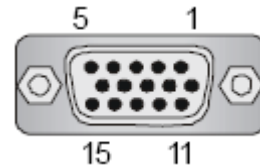

2.3.7 Audio Jack (CN4)

Install an audio driver, and then attach audio devices to CN4.

Pin Color	Signal
Blue	Line-in
Green	Line-out
Pink	MIC-in



2.3.8 LAN and USB 3.2 Connectors (CN5 and CN6)

The motherboard comes with two high performance plug and play Ethernet interfaces (RJ-45) which are fully compliant with the IEEE 802.3 standard. Connection can be established by plugging one end of the Ethernet cable into this RJ-45 connector and the other end to a (LAN2/CN5)1000/100/10 (LAN1/CN6)2500/1000/100/10 Base-T hub.

The Universal Serial Bus Compliant with USB 3.2 Gen2x1 (10Gbps) (CN6) or USB3.2 Gen2x1 (10Gbps) (CN5) connectors on the rear I/O are for connecting USB peripherals such as a keyboard, mouse, scanner, etc.

Pin	LAN Signal	Pin	LAN Signal
L1	Tx+ (Data transmission positive)	L2	Tx- (Data transmission negative)
L3	Rx+ (Data reception positive)	L4	RJ-1 (For 1000 Base-T only)
L5	RJ-1 (For 1000 Base-T only)	L6	Rx- (Data reception negative)
L7	RJ-1 (For 1000 Base-T only)	L8	RJ-1 (For 1000 Base-T only)
A	100 LAN LED (Green) / 1000 LAN LED (Orange)	B	Active LED

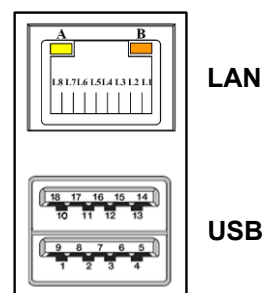

Note

- **GbE Speed LED turns orange for 1000Mbps or green for 100Mbps. The light is off for 10Mbps.**
- **2.5GbE Speed LED turns orange for 2500Mbps or green for 1000Mbps and 100Mbps. The light is off for 10Mbps.**
- **CN6 supports AMT and USB3.2 Gen 2x1 (10Gbps). Both CN5 and CN6 support Wake-on-LAN.**

Pin	USB Signal	Pin	USB Signal
1	USB3_POWER	2	USB1 -
3	USB1 +	4	GND
5	USB3_SSRX1-	6	USB3_SSRX1+
7	GND	8	USB3_SSTX1-
9	USB3_SSTX1+	10	USB3_POWER
11	USB2 -	12	USB2 +
13	GND	14	USB3_SSRX2-
15	USB3_SSRX2+	16	GND
17	USB3_SSTX2-	18	USB3_SSTX2+

2.3.9 GPIO Header (CN7)

This header (5x2-pin p=2.00mm) is for digital I/O interface.

Pin	Signal	Pin	Signal
1	DIO1	2	DIO8
3	DIO2	4	DIO7
5	DIO3	6	DIO6
7	DIO4	8	DIO5
9	NC	10	GND

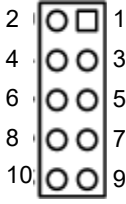



The default value of DIO1 to DIO8 is set as GPI with high level.

Note

2.3.10 Internal Keyboard Connector (CN8)

The internal keyboard (PS/2 type) interface is available through a 5-pin connector.

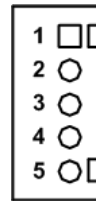
Pin	Signal
1	Keyboard Clock
2	Keyboard Data
3	NC
4	GND
5	+5V level



2.3.11 Internal Mouse Connector (CN9)

The internal mouse (PS/2 type) interface is available through a 5-pin connector.

Pin	Signal
1	Mouse Clock
2	Mouse Data
3	NC
4	GND
5	+5V level

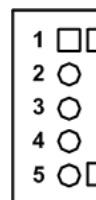

2.3.12 M.2 2280 Key M NVMe SSD (CN10)

The CN10 (5x1-pin p=2.00mm) is for SMBus (System Management Bus) interface.

Pin	Signal	Pin	Signal	Pin	Signal	Pin	Signal
1	GND	2	+3.3V	3	GND	4	+3.3V
5	PERn3	6	NC	7	PERp3	8	NC
9	GND	10	LED_1#	11	PETn3	12	+3.3V
13	PETp3	14	+3.3V	15	GND	16	+3.3V
17	PERn2	18	+3.3V	19	PERp2	20	NC
21	GND	22	NC	23	PETn2	24	NC
25	PETp2	26	NC	27	GND	28	NC
29	PERn1	30	NC	31	PERp1	32	NC
33	GND	34	NC	35	PETn1	36	NC
37	PETp1	38	NC	39	GND	40	NC
41	PERn0	42	NC	43	PERp0	44	NC
45	GND	46	NC	47	PETn0	48	NC
49	PETp0	50	PERST#	51	GND	52	CLKREQ#
53	REFCLKn	54	PEWAKE#	55	REFCLKp	56	NC
57	GND	58	NC	59	CONNECTOR Key M	60	CONNECTOR Key M
61	CONNECTOR Key M	62	CONNECTOR Key M	63	CONNECTOR Key M	64	CONNECTOR Key M
65	CONNECTOR Key M	66	CONNECTOR Key M	67	NC	68	NC
69	NC	70	+3.3V	71	GND	72	+3.3V
73	GND	74	+3.3V	75	GND		

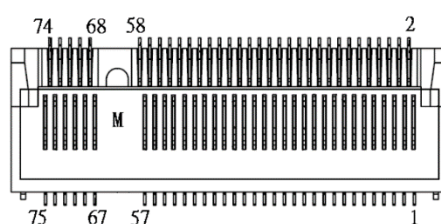

2.3.13 SMBus Header (CN12)

The CN12 (5x1-pin p=2.00mm) is for SMBus (System Management Bus) interface.

Pin	Signal	Pin	Signal
1	SMB_SCL	2	N/C
3	GND	4	SMB_SDA
5	+5V		

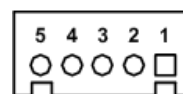

2.3.14 Internal USB Headers (CN13, CN15)

These are 5x2-pin p=2.54mm headers for USB 2.0 interface.

Pin	Signal	Pin	Signal
1	+5 V_DUAL	2	+5 V_DUAL
3	USB -	4	USB -
5	USB +	6	USB +
7	GND	8	GND
		10	GND

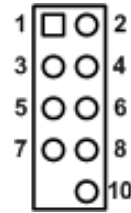

2.3.15 PCI-Express Mini Card Connector (CN16)

The CN16 complies with PCI-Express Mini Card Spec. V1.2.

Pin	Signal	Pin	Signal
1	PCH_WAKE_N	2	+3.3V_DUAL
3	N/C	4	GND
5	N/C	6	+1.5V
7	+3.3V_DUAL	8	UIM_PWR
9	GND	10	UIM_DAT
11	CLKOUT_PCIE_N3	12	UIM_CLK
13	CLKOUT_PCIE_P3	14	UIM_RST
15	GND	16	UIM_VPP
17	N/C	18	GND
19	N/C	20	RF_KILL#_WIFI
21	GND	22	BUF_PLT_RST_N
23	PCIE7_RX_DN	24	+3.3V_DUAL
25	PCIE7_RX_DP	26	GND
27	GND	28	+1.5V
29	GND	30	SMB_CLK_RESUME
31	PCIE7_TX_DN	32	SMB_DATA_RESUME
33	PCIE7_TX_DP	34	GND
35	GND	36	USB10-
37	GND	38	USB10+
39	+3.3V_DUAL	40	GND
41	+3.3V_DUAL	42	N/C
43	GND	44	N/C
45	CL_CLK	46	N/C
47	CL_DATA	48	+1.5V
49	CL_RST_N	50	GND
51	N/C	52	+3.3V_DUAL

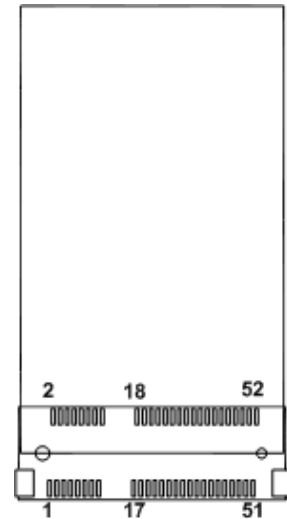

Screw type is M2*0.4.

Note

2.3.16 TPM Pin Header (CN19)

These are 7x2-pin p=2.0mm headers for SPI interface with an AX93515 TPM module.

Pin	Signal	Pin	Signal
1	VCC3P3	2	GND
3	MOSI	4	MISO
5	CLK	6	CS2
7	RST	8	PIRQ
9	PP	10	NC
11	NC	12	NC
13	NC	14	MC

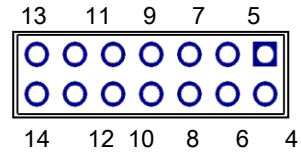

Note

The screw type is M2*0.4.

2.3.17 Front Panel Header (CN17)

This is a front panel header (7x2-pin p=2.54mm).

Pin	Signal
1	Power LED+
2	SPK- [*]
3	GND
4	BUZZER
5	Power LED-
6	N/C
7	N/C
8	SPK+ [*]
9	PWR-
10	PWR+
11	RESET-
12	RESET+
13	HD LED-
14	HD LED+

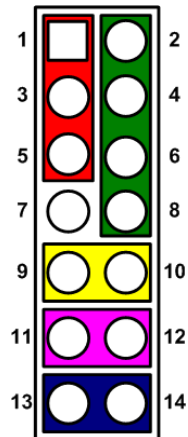

Note

[*]: The buzzer on the motherboard will be active when pin 2 and pin 4 are connected; the external speaker on the chassis will be active when pin 2 and pin 4 are open.

2.3.18 Power Input Connectors (ATX1 and CN18)

Steady and sufficient power can be supplied to all components on the motherboard by connecting the power connector. Please make sure all components and devices are properly installed before connecting the power connector.

An external power supply plug fits into ATX1 and CN18 in only one orientation. Properly press down power supply plug until it completely and firmly fits into the connector. Loose connection may cause system instability.

ATX1 CPU power input connector:

Pin	ATX1 Signal	Pin	ATX1 Signal
1	GND	5	+12V
2	GND	6	+12V
3	GND	7	+12V
4	GND	8	+12V

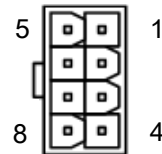

CN18 24-pin power input connector:

Pin	CN19 Signal	Pin	CN19 Signal
1	3.3V	13	3.3V
2	3.3V	14	-12V
3	GND	15	GND
4	+5V	16	PS_ON
5	GND	17	GND
6	+5V	18	GND
7	GND	19	GND
8	PWR OK	20	-5V
9	5VSB	21	+5V
10	+12V	22	+5V
11	+12V	23	+5V
12	3.3V	24	GND

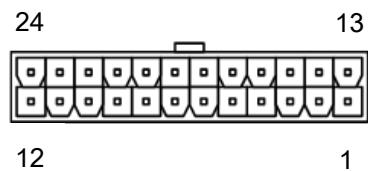

2.3.19 Internal USB 3.2 Gen1 (5Gbps) Connector (CN20 and CN21)

The CN20 & CN21 is a 19-pin internal connector for installing various USB 3.2 Gen1(5Gbps) compliant peripherals.

Pin	Signal	Pin	Signal
1	VBUS0		
2	SSRX5-	19	VBUS1
3	SSRX5+	18	SSRX6-
4	GND	17	SSRX6+
5	SSTX5-	16	GND
6	SSTX5+	15	SSTX6-
7	GND	14	SSTX6+
8	USB10-	13	GND
9	USB10+	12	USB11-
10	ID	11	USB11+

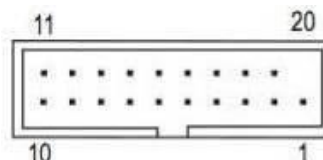

2.3.20 COM Headers (COM3, COM4, COM5, COM6)

The motherboard comes with 5x2-pin p=2.54mm headers for COM serial port interfaces.

COM3, COM4, COM5, COM6:

Pin	Signal		Pin	Signal
1	DCD#		2	DSR#
3	RXD#		4	RTS#
5	TXD#		6	CTS#
7	DTR#		8	RI#
9	GND		10	N/C

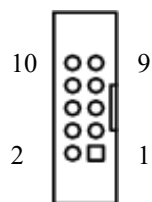

2.3.21 Fan Connectors (FAN1, FAN2, FAN3)

This motherboard has three fan connectors. Find fan speed option(s) at BIOS Setup Utility: Advanced\HW Monitor\PC Health Status.

The FAN1 (4x1-pin p=2.54mm) is for the CPU fan connector.

Pin	Signal
1	GND
2	+12V
3	FAN Speed Detection
4	FAN Speed Control



The FAN2 and FAN3 (4x1-pin p=2.54mm) are for system fan connectors.

Pin	Signal
1	GND
2	+12V
3	FAN Speed Detection
4	FAN Speed Control

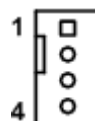

2.3.22 PCI-Express x4 Slots (PCIe2, PCIe3, PCIe5)

This motherboard has three PCI-Express x4 slots

Pin	Signal	Pin	Signal
B1	+12V_PS	A1	GND
B2	+12V_PS	A2	+12V_PS
B3	+12V_PS	A3	+12V_PS
B4	GND	A4	GND
B5	SMB_CLK_RESUME	A5	N/C
B6	SMB_DATA_RESUME	A6	N/C
B7	GND	A7	N/C
B8	+3.3V_PS	A8	N/C
B9	N/C	A9	+3.3V_PS
B10	+3.3V_SB	A10	+3.3V_PS
B11	PCH_WAKE_N	A11	PWRGD
B12	N/C	A12	GND
B13	GND	A13	CLKOUT_PCIE_P5
B14	PCIE1_SLOT1_TX_DP_C	A14	CLKOUT_PCIE_N5
B15	PCIE1_SLOT1_TX_DN_C	A15	GND
B16	GND	A16	PCIE1_SLOT1_RX_DP_C
B17	PCIEX4_SLOT1_PRSENT2_N	A17	PCIE1_SLOT1_RX_DN_C
B18	GND	A18	GND
B19	PCIE2_TX_DP	A19	N/C
B20	PCIE2_TX_DN	A20	GND
B21	GND	A21	PCIE2_RX_DP
B22	GND	A22	PCIE2_RX_DN
B23	PCIE3_TX_DP	A23	GND
B24	PCIE3_TX_DN	A24	GND
B25	GND	A25	PCIE3_RX_DP
B26	GND	A26	PCIE3_RX_DN
B27	PCIE4_TX_DP	A27	GND
B28	PCIE4_TX_DN	A28	GND
B29	GND	A29	PCIE4_RX_DP
B30	N/C	A30	PCIE4_RX_DN
B31	N/C	A31	GND
B32	GND	A32	N/C

2.3.23 SATA 3.0 Connectors (SATA1 , SATA2)

These Serial Advanced Technology Attachment (Serial ATA or SATA) connectors are for SATA 3.0 interface allowing up to 6.0Gb/s data transfer rate. It is a computer bus interface for connecting to devices such as hard disk drive.

Pin	Signal
1	GND
2	SATA_TX+
3	SATA_TX-
4	GND
5	SATA_RX-
6	SATA_RX+
7	GND

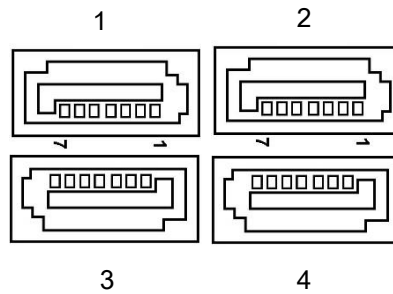

Section 3

Hardware Description

3.1 Microprocessors

The IMB540 series supports Intel® Core™ i9 / i7/ i5/ i3/ Pentium®, Celeron® processors (Alder lake S), which enable your system to operate under Windows® 10 and Linux environments. The system performance depends on the microprocessor. Make sure all correct settings are arranged for your installed microprocessor to prevent the CPU from damages.



Note

Caution: Make sure turnoff the power before you install the processor into the CPU socket.

3.2 BIOS

The IMB540 series uses AMI Plug and Play BIOS.

3.3 System Memory

The IMB540 supports four 288-pin DDR4 DIMM sockets for maximum memory capacity up to 128GB DDR4 SDRAMs. The memory module comes in sizes of 2GB, 4GB, 8GB, 16GB and 32GB.

This page is intentionally left blank.

Section 4

AMI BIOS Setup Utility

The AMI UEFI BIOS provides users with a built-in setup program to modify basic system configuration. All configured parameters are stored in a flash chip to save the setup information whenever the power is turned off. This chapter provides users with detailed description about how to set up basic system configuration through the AMI BIOS setup utility.

4.1 Starting

To enter the setup screens, follow the steps below:

1. Turn on the computer and press during the Power On Self Test (POST) to enter BIOS setup, otherwise, POST will continue with its test routines.
2. Once you enter the BIOS, the main BIOS setup menu displays. You can access the other setup screens from the main BIOS setup menu, such as the Advanced and Chipset menus.



Note

If your computer cannot boot after making and saving system changes with BIOS setup, you can restore BIOS optimal defaults by setting press the tact switch "SW1" for 5 seconds (see section 2.3.3).

It is strongly recommended that you should avoid changing the chipset's defaults. Both AMI and your system manufacturer have carefully set up these defaults that provide the best performance and reliability.

4.2 Navigation Keys

The BIOS setup/utility uses a key-based navigation system called hot keys. Most of the BIOS setup utility hot keys can be used at any time during the setup navigation process. These keys include <F1>, <F2>, <Enter>, <ESC>, <Arrow> keys, and so on.



Note

Some of the navigation keys differ from one screen to another.

Hot Keys	Description
←→ Left/Right	The Left and Right <Arrow> keys allow you to select a setup screen.
↑↓ Up/Down	The Up and Down <Arrow> keys allow you to select a setup screen or sub screen.
Enter	The <Enter> key allows you to display or change the setup option listed for a particular setup item. The <Enter> key can also allow you to display the setup sub screens.
+– Plus/Minus	The Plus and Minus <Arrow> keys allow you to change the field value of a particular setup item.
F1	The <F1> key allows you to display the General Help screen.
F2	The <F2> key allows you to Load Previous Values.
F3	The <F3> key allows you to Load Optimized Defaults.
F4	The <F4> key allows you to save any changes you have made and exit Setup. Press the <F4> key to save your changes.
Esc	The <Esc> key allows you to discard any changes you have made and exit the Setup. Press the <Esc> key to exit the setup without saving your changes.

4.3 Main Menu

When you first enter the setup utility, you will enter the Main setup screen. You can always return to the Main setup screen by selecting the Main tab. System Time/Date can be set up as described below. The Main BIOS setup screen is shown below.

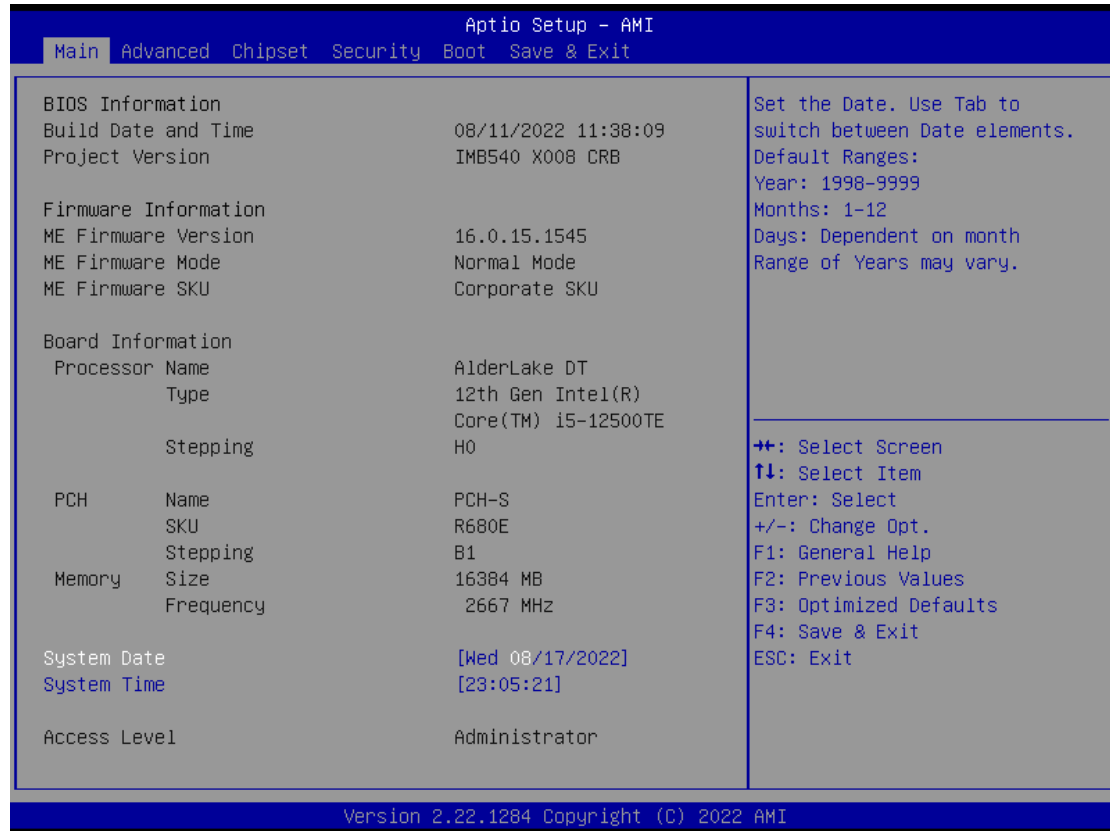

BIOS Information

Display the BIOS information.

System Date/Time

Use this option to change the system time and date. Highlight System Time or System Date using the <Arrow> keys. Enter new values through the keyboard. Press the <Tab> key or the <Arrow> keys to move between fields. The date must be entered in MM/DD/YY format. The time is entered in HH:MM:SS format.

Access Level

Display the access level of current user.

4.4 Advanced Menu

The Advanced menu also allows users to set configuration of the CPU and other system devices. You can select any of the items in the left frame of the screen to go to the sub menus:

- ▶ Trusted Computing
- ▶ Platform Misc Configuration
- ▶ CPU Configuration
- ▶ Storage Configuration
- ▶ NVMe Configuration
- ▶ AMT configuration
- ▶ F81966 Super IO Configuration
- ▶ Hardware Monitor
- ▶ USB Configuration
- ▶ PCI Subsystem Settings
- ▶ CSM Configuration

For items marked with “▶”, please press <Enter> for more options.

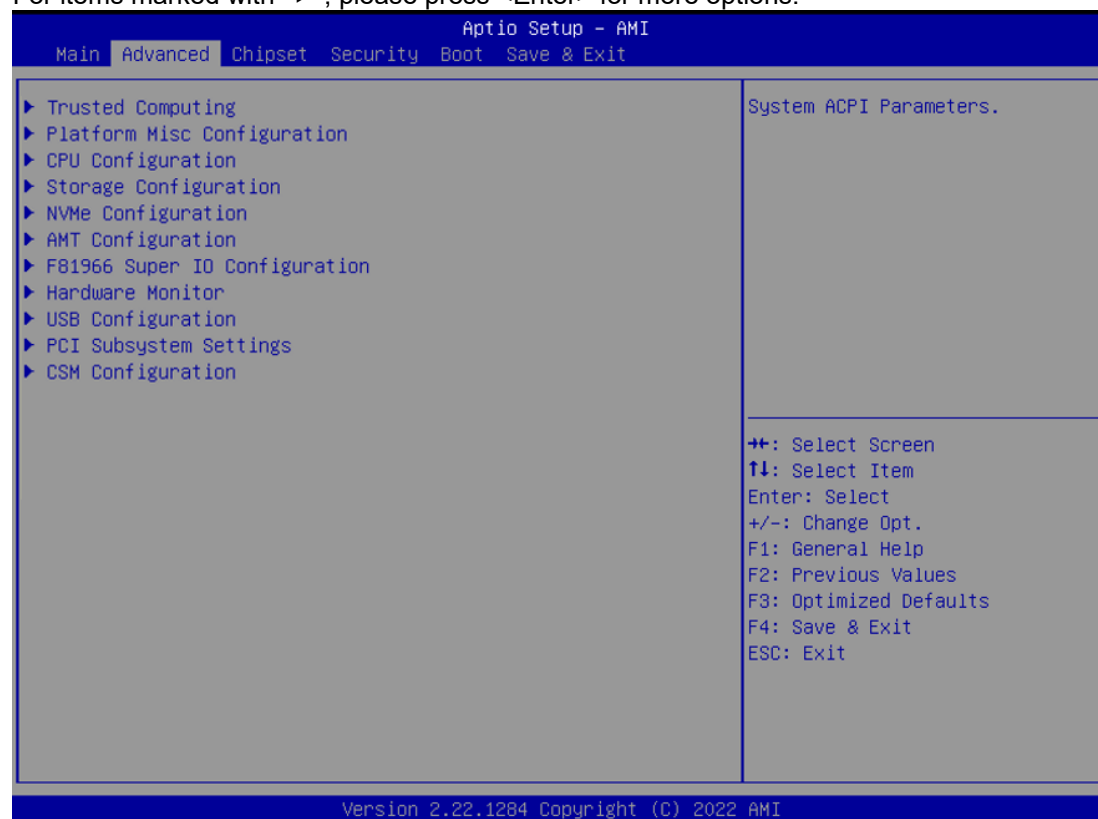

- **Trusted Computing**

Enable or disable security device support.

Advanced		Aptio Setup - AMI
TPM 2.0 Device Found Firmware Version: Vendor: Security Device Support [Enable] Active PCR banks N/A, reset required Available PCR banks N/A, reset required	Enables or Disables BIOS support for security device. O.S. will not show Security Device. TCG EFI protocol and INT1A interface will not be available.	
		++: Select Screen ↑↓: Select Item Enter: Select +/-: Change Opt. F1: General Help F2: Previous Values F3: Optimized Defaults F4: Save & Exit ESC: Exit
Version 2.22.1284 Copyright (C) 2022 AMI		

● **Platform Misc Configuration**

This screen allows you to set Platform Misc Configuration.



Native PCIE Enable

Bit - PCIe Native * control
 0 - ~ Hot Plug
 1 - SHPC Native Hot Plug control
 2 - ~ Power Management Events
 3 - PCIe Advanced Error Reporting control
 4 - PCIe Capability Structure control
 5 - Latency Tolerance Reporting control.

Native ASPM

Enabled - OS Controlled ASPM, Disabled - BIOS Controlled ASPM.

- **CPU Configuration**

This screen shows CPU information, and you can change the value of the selected option.

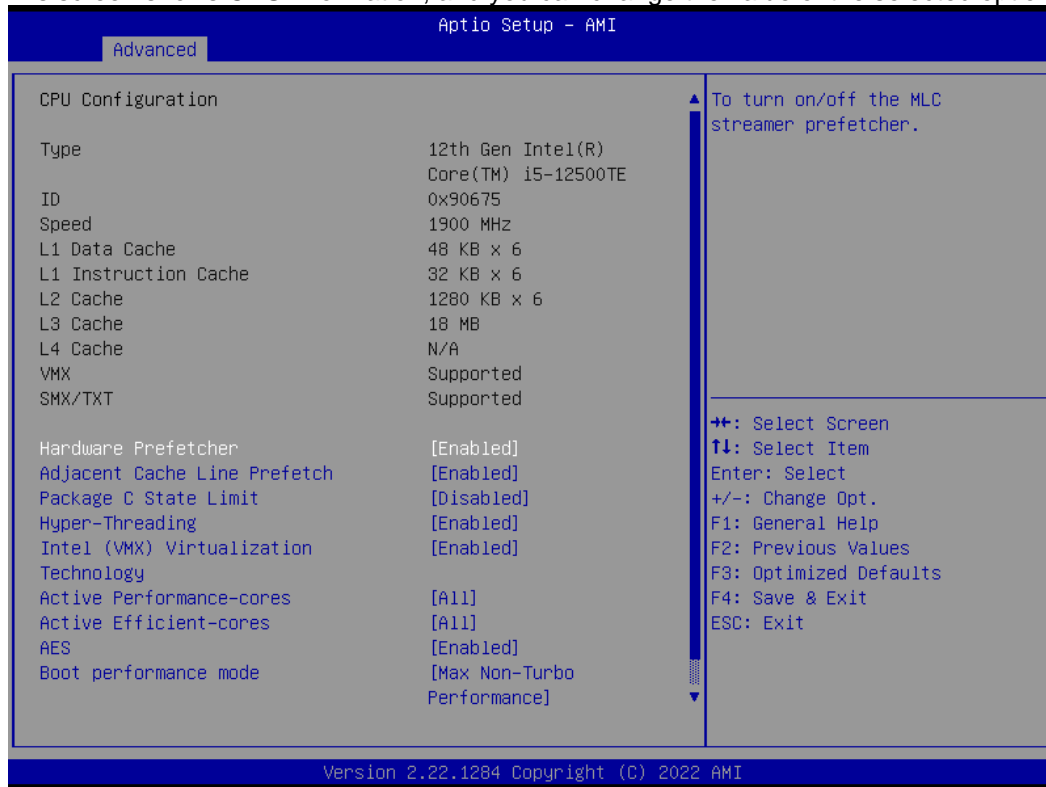

Hardware Prefetcher

Turn on/off the MLC streamer prefetcher.

Adjacent Cache Line Prefetch

Turn on/off prefetching of adjacent cache lines.

Package C State Limit

Maximum Package C State Limit Setting. CPU Default: Sets to Factory default value. Auto: Initializes to deepest available Package C State Limit.

Hyper-Threading

Enable or disable Hyper-threading Technology, which allows a single physical processor to multitask as multiple logical processors. When disabled, only one thread per enabled core is enabled.

Intel Virtualization Technology

Enable or disable Intel Virtualization Technology. When enabled, a VMM (Virtual Machine Mode) can utilize the additional hardware capabilities. It allows a platform to run multiple operating systems and applications independently, hence enabling a single computer system to work as several virtual systems.

Active Performance Cores

Number of cores to enable in each processor package.

Active Efficient Cores

Number of E-cores to enable in each processor package. Note: Number of P-Cores and E-cores are counted together. When both are {0,0}, P-code will enable all cores.

AES

Enable / Disable AES (Advanced Encryption Standard)

Boot performance mode

Select the performance mode that the BIOS will run after the reset.

Intel (R) SpeedStep(tm)

Allows more than two frequency ranges to be supported.

Turbo Mode

Allows to enable processor cores to raise the operating frequency.

- **Storage Configuration**

This screen shows storage information.

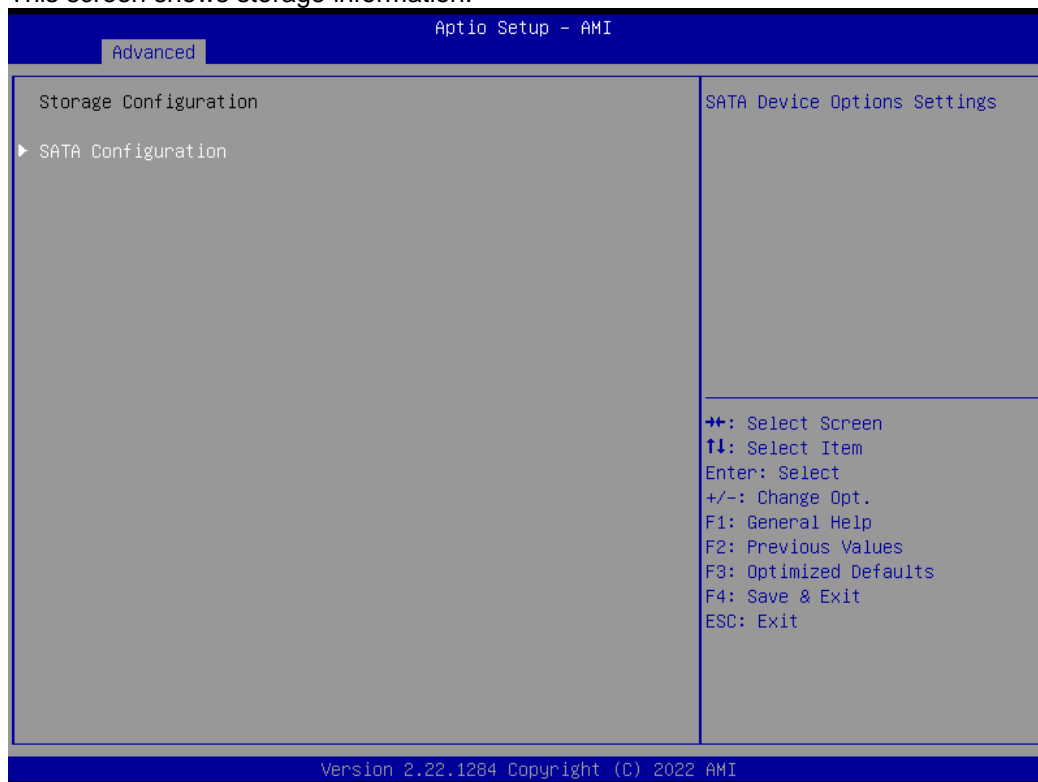

- **SATA Configuration**

During system boot up, the BIOS automatically detects the presence of SATA devices. In the SATA Configuration menu, you can see the hardware currently installed in the SATA ports.



SATA Controller(s)

Enable or disable the SATA Controller feature. The default is Enabled.

VMD Setup Menu

VMD Configuration settings. The default is Disabled.

Hot Plug

Designates this port as Hot Pluggable.

Spin Up Device

Staggered Spin Up will be performed when any of the drive is enabled for the performance strategy. Otherwise, all drives spin up at boot. Only HDD supports this function.

SATA Device Type

Identify the SATA port is connected to a solid-state drive (SSD) or hard disk drive (HDD).

- **NVMe Configuration**

This screen shows NVMe device information.

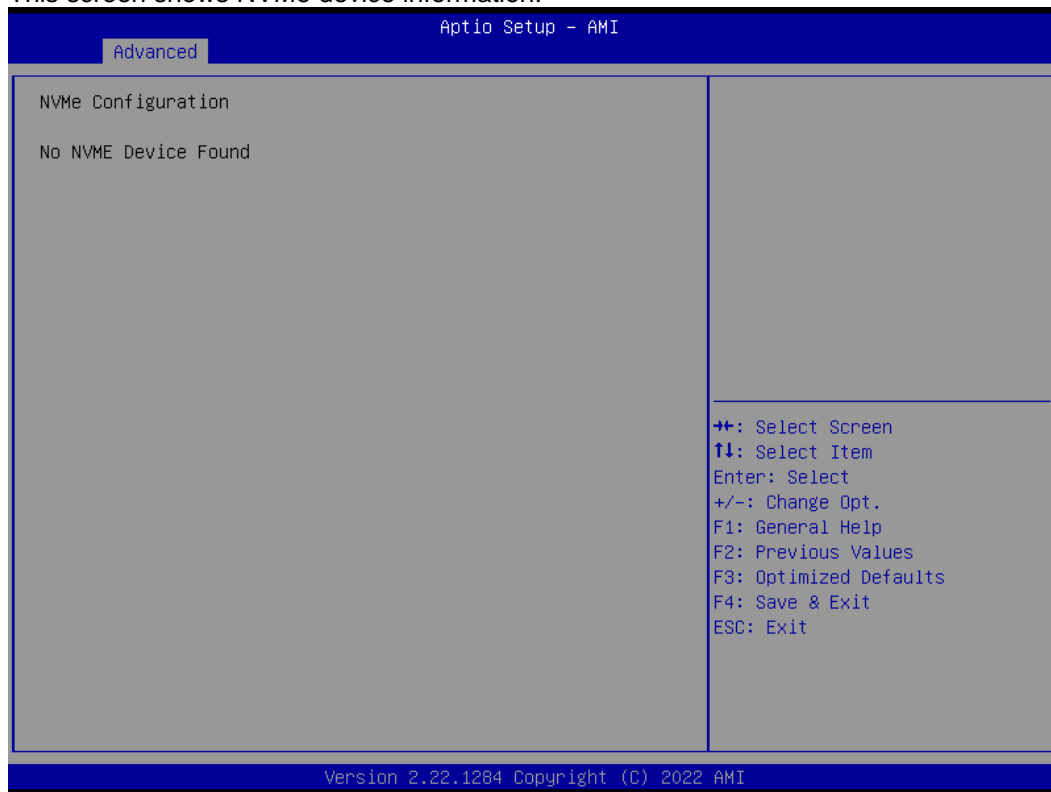

- **AMT Configuration**

This screen displays Active Management Technology information.

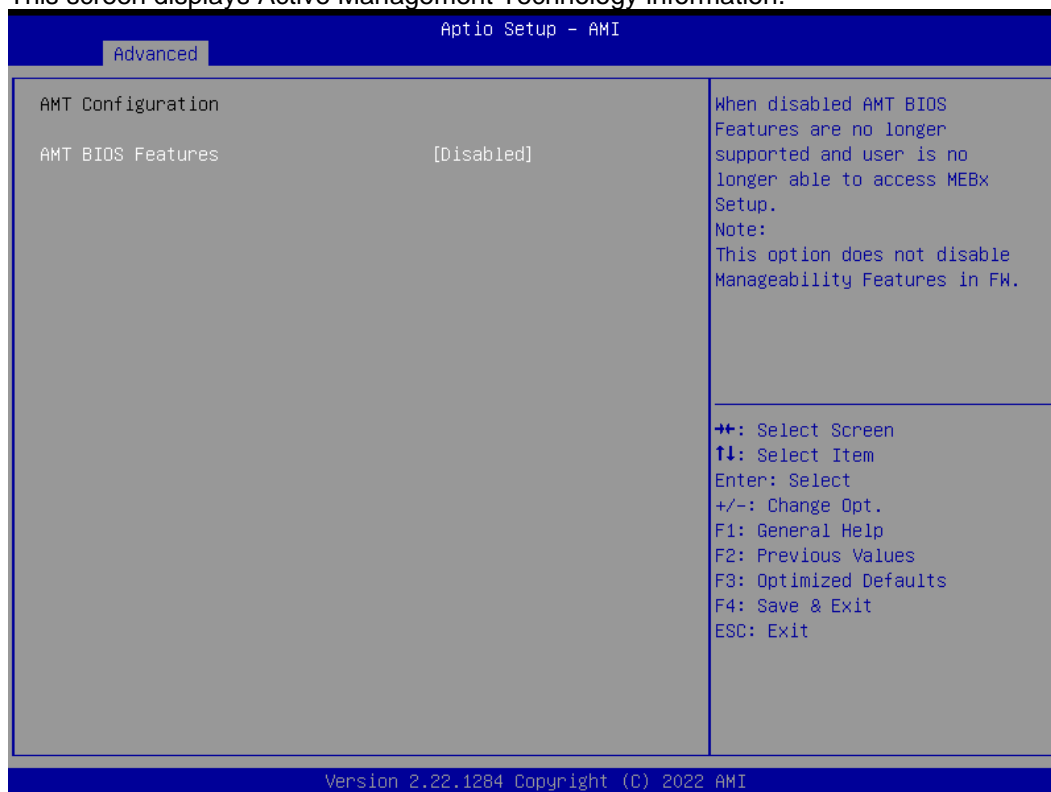

AMT BIOS Features

Enable or disable Active Management Technology BIOS features. The default is Enabled.

- **F81966 Super IO Configuration**

You can use this screen to select options for the Super IO Configuration, and change the value of the selected option. A description of the selected item appears on the right side of the screen. For items marked with “▶”, please press <Enter> for more options.

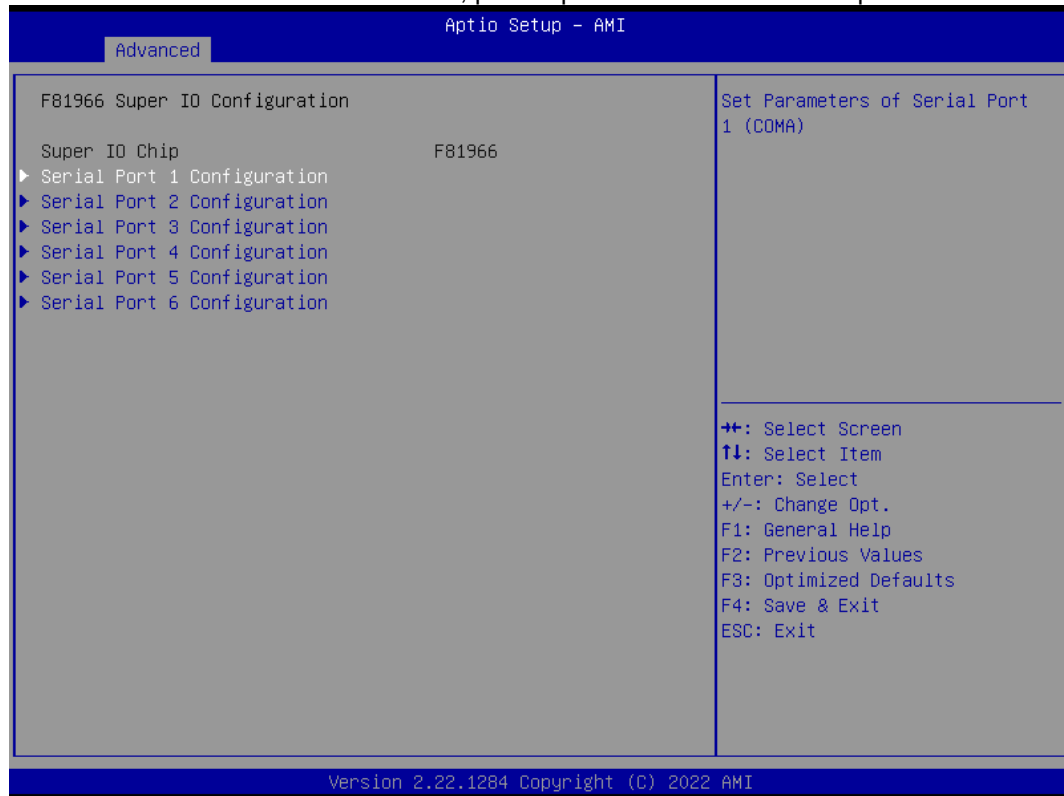

Serial Port 1

This item allows you to use it as RS232/422/485. The default is RS232.

Serial Port 2

This item allows you to use it as RS232/422/485. The default is RS232.

Serial Port 3~6

This item allows you to use RS232 only .

- **Serial Port 1 Configuration**

Use these items to set parameters related to serial port 1 and 2.

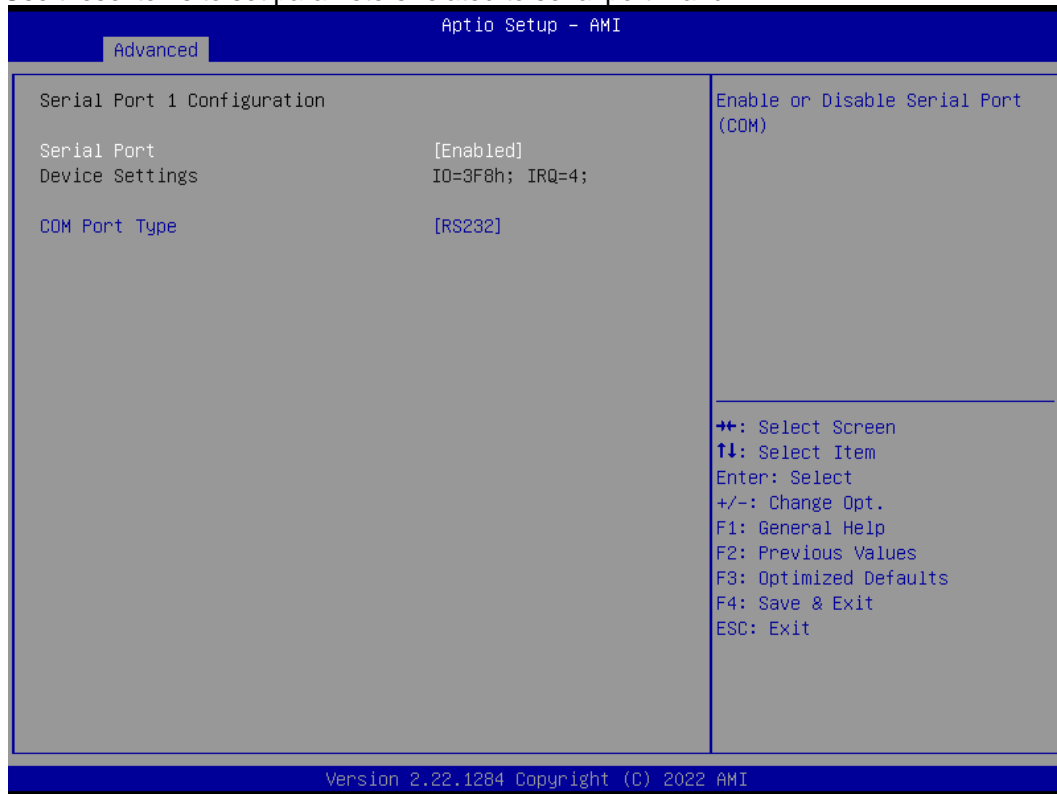

Serial Port 1

This item allows you to use it as RS232/422/485. The default is RS232.

Serial Port 2

This item allows you to use it as RS232/422/485. The default is RS232.

Serial Port 3~6

This item allows you to use RS232 only .

- **Hardware Monitor**

This screen monitors hardware health status.

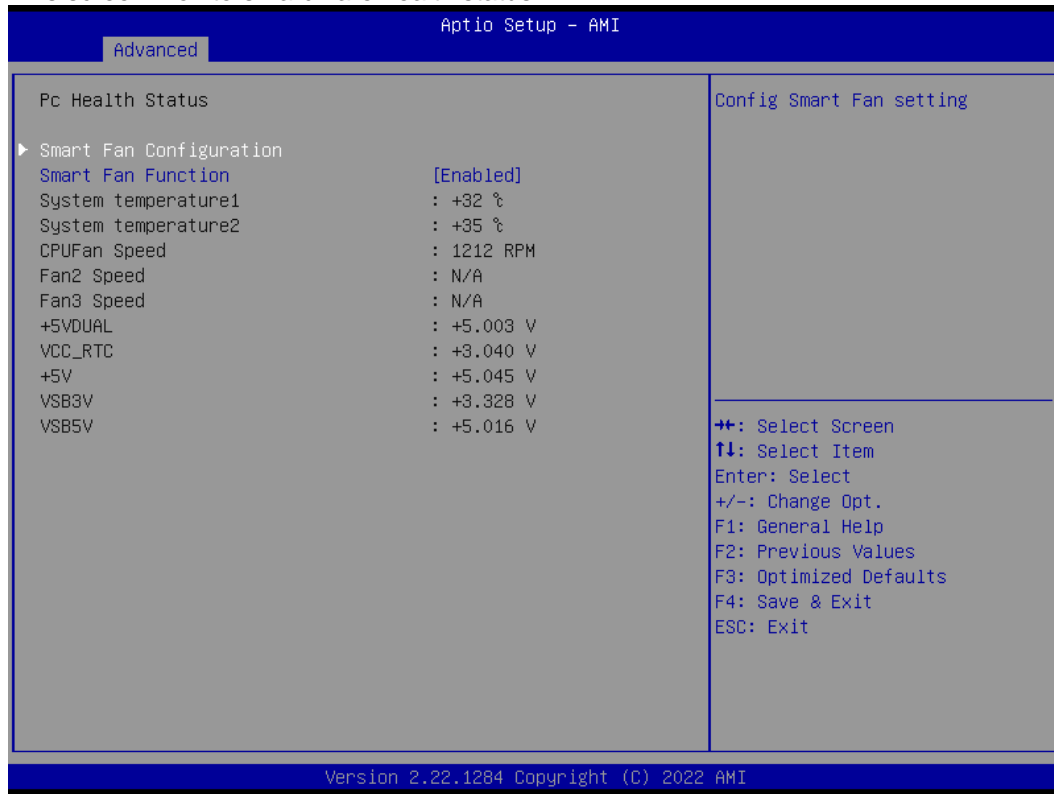

This screen displays the temperature of system and CPU, cooling fans speed in RPM and system voltages (VCC_CPU, DDR, +12V, +5V and +3.3V).



Note

CPU FAN = FAN1; SYS FA = FAN2; AUX FAN = FAN3.

- **USB Configuration**

This screen shows USB configuration.



- **PCI Subsystem Settings**

This screen allows you to set PCI Subsystem mode.

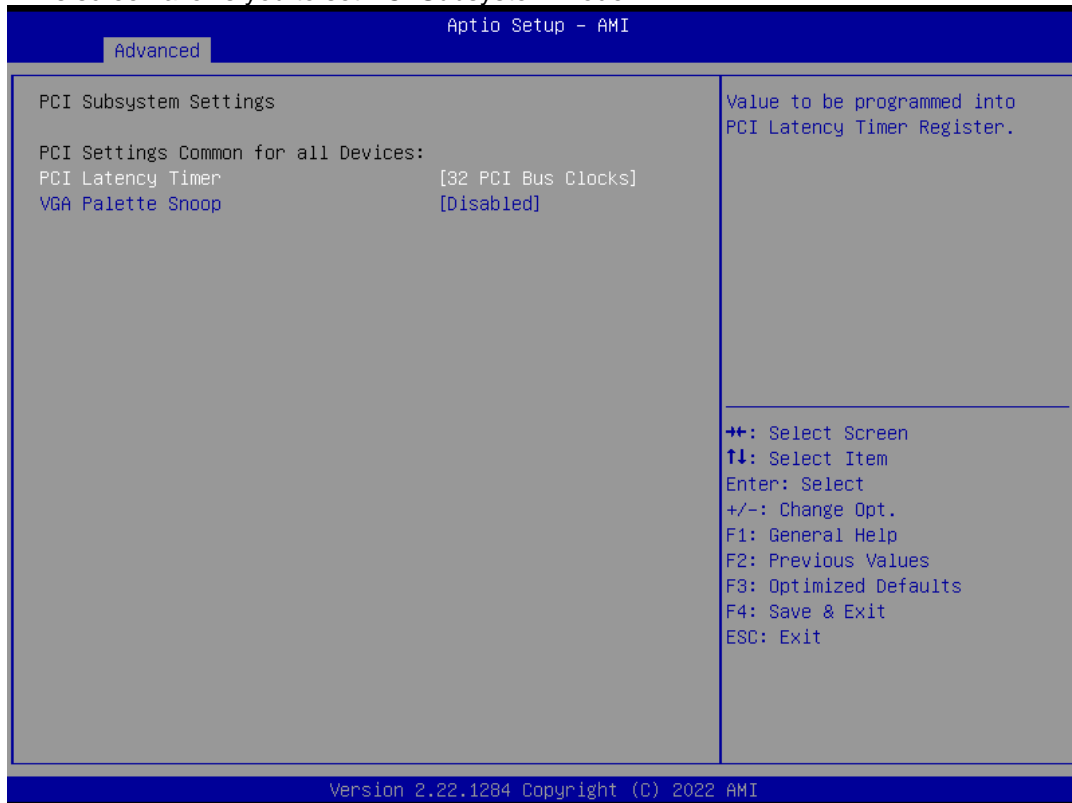

PCI Latency Timer

Set the value to be programmed into PCI Latency Timer Register.

VGA Palette Snoop

Enables or Disables VGA Palette Registers Snooping.

- **Compatibility Support Module (CSM) Configuration**

This screen displays CSM information.

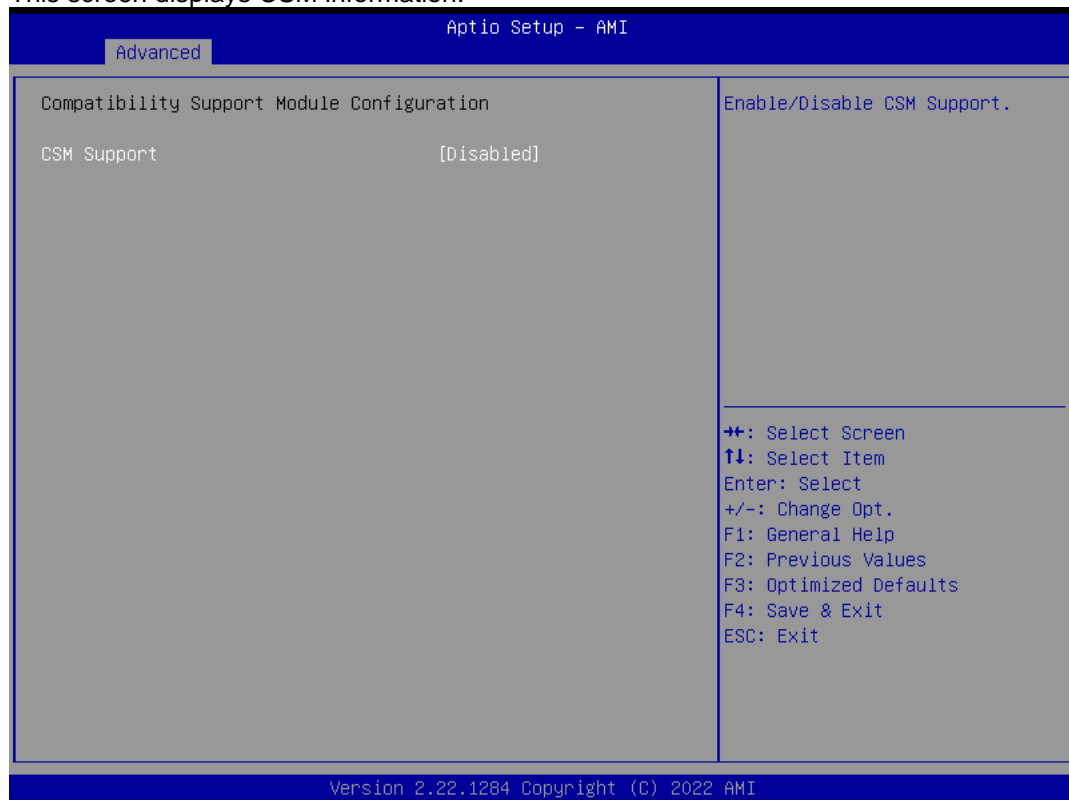

CSM Support

Enabled / Disable CSM Support.

GateA20 Active

UPON REQUEST - GA20 can be disabled using BIOS services. ALWAYS - do not allow to disable GA20. This option is useful when any RT code is executed above 1MB.

Option ROM Messages

Set display mode for Option ROM.

INT19 Trap Response

BIOS reaction on INT19 trapping by Option ROM: IMMEDIATE - execute the trap right away; POSTPONED - execute the trap during legacy boot.

Boot option filter

This option controls Legacy/UEFI ROMs priority.

Storage

Controls the execution of UEFI and Legacy Storage OpROM.

Video

Controls the execution of UEFI and Legacy Video OpROM.

Other PCI devices

Determines OpROM execution policy for devices other than Network, Storage, or Video.

4.5 Chipset Menu

The Chipset menu allows users to change the advanced chipset settings. You can select any of the items in the left frame of the screen to go to the sub menus:

- ▶ System Agent (SA) Configuration
- ▶ PCH-IO Configuration

For items marked with “▶”, please press <Enter> for more options.



- **System Agent (SA) Configuration**

This screen allows users to configure System Agent (SA) parameters. For items marked with “▶”, please press <Enter> for more options.



VT-d

Check to enable VT-d function on MCH.

Above 4GB MMIO BIOS assignment

Enable/Disable above 4GB Memory Mapped IO BIOS assignment \n\n. This is enabled automatically when Aperture Size is set to 2048MB.

Graphics Configuration

Open the sub menu for parameters related to graphics configuration.

CPU PCI Express Root Port

Set the ASPM Level and PCI Express Speed.

- **Graphics Configuration**

This screen shows graphics configuration.

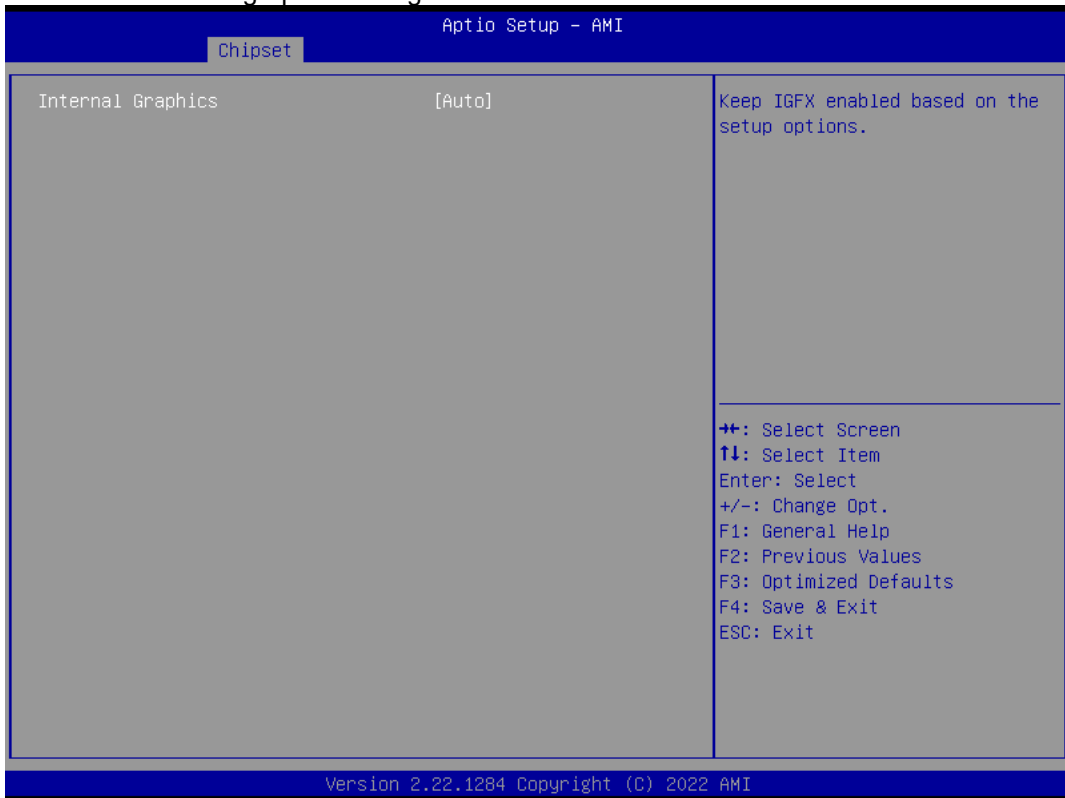

Internal Graphics

Keep IGFX enabled based on the setup options.

- **CPU PCI Express Root Port**

This screen shows CPU PCI Express root port information.

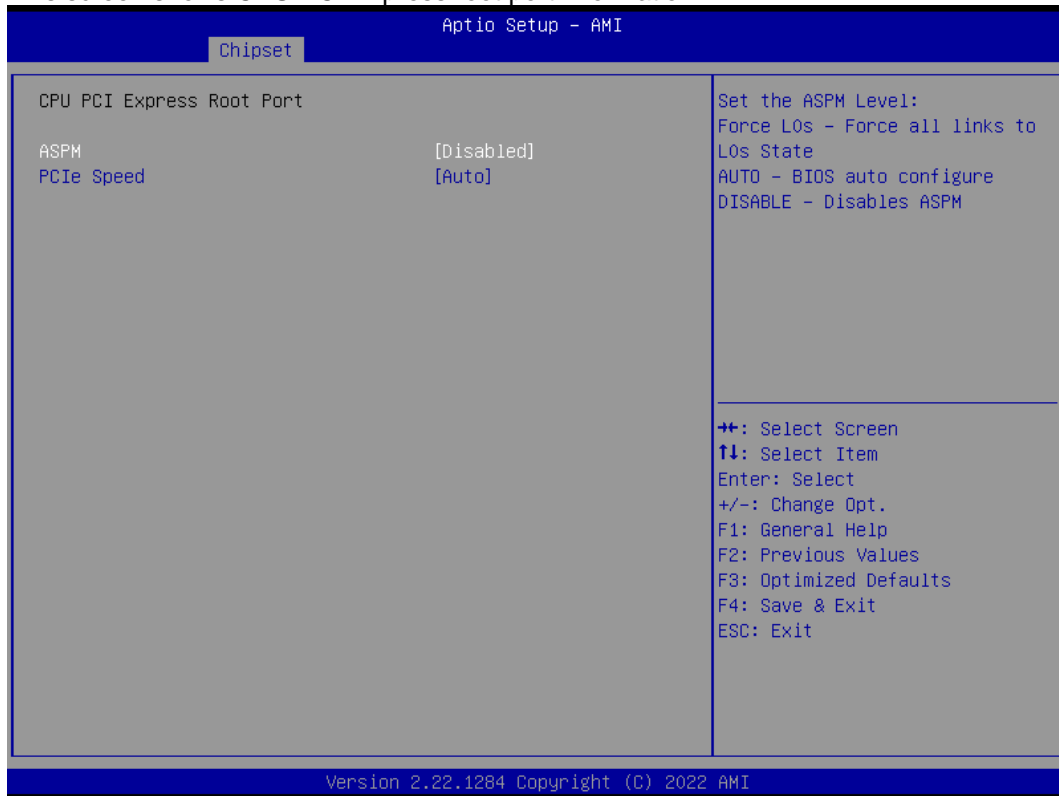

ASPM

Set the ASPM Level:\nForce L0s - Force all links to L0s State\nForce L1 - Force all links to L1 State\nForce L0sL1 - Force all links to L0SL1 State\nDISABLE - Disables ASPM.

PCIe Speed

Configure PCIe Speed.

- **PCH-IO Configuration**

This screen allows you to set PCH parameters.

**PCI Express Configuration**

Configure PCIe Speed.

HD Audio Configuration

Enable or disable HD Audio.

Wake on LAN Enable

Enable or disable integrated LAN to wake the system.

- **PCI Express Configuration**

This screen shows PCI Express configuration.

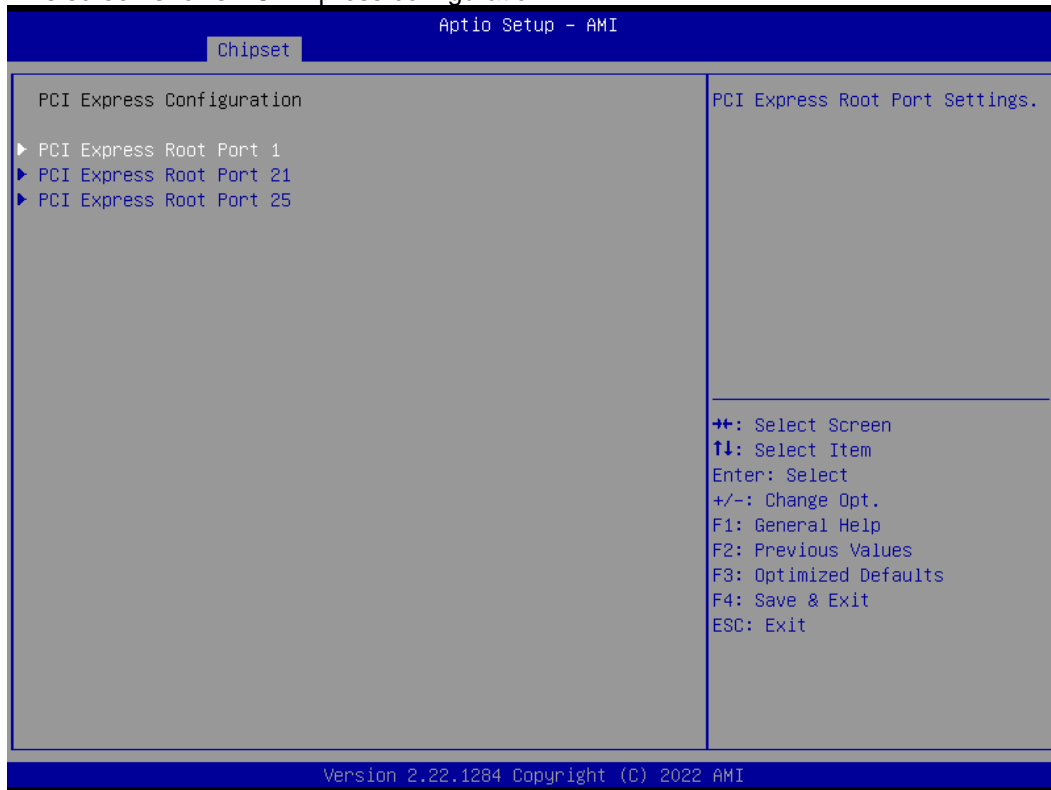

Note

***PCIE 1 -> PCIE5
PCIE 21-> PCIE3
PCIE 25-> PCIE2***

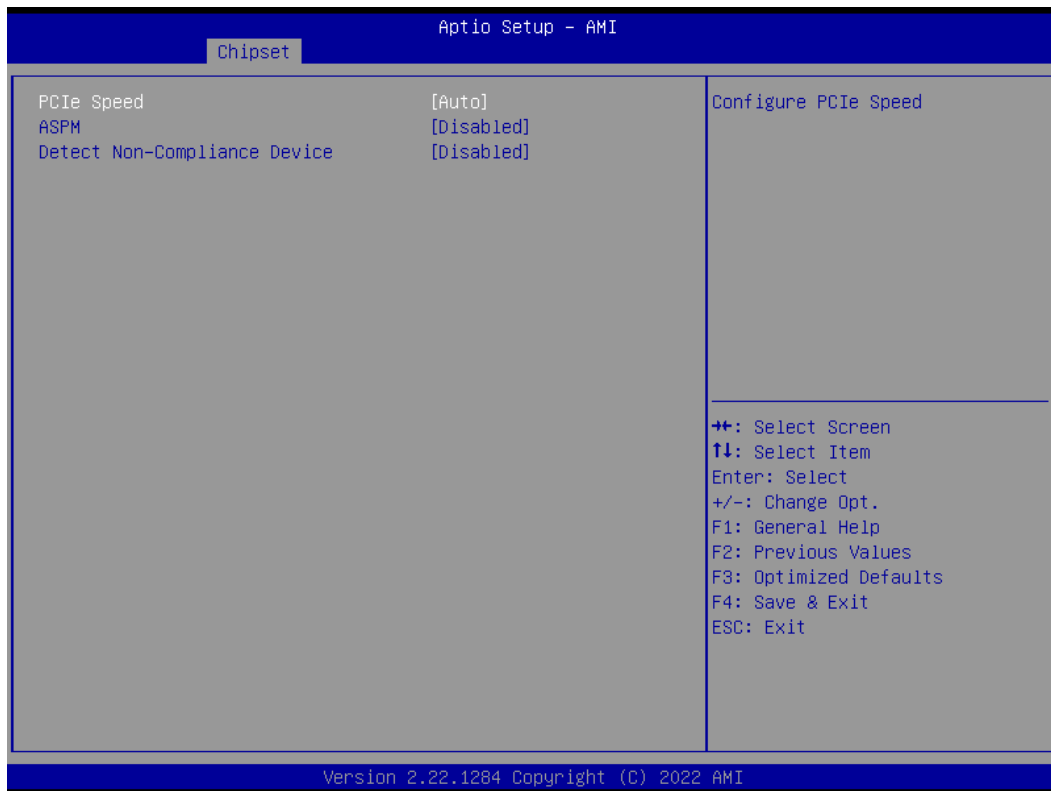
**PCIe Speed**

Configure PCIe Speed.

ASPM

Set the ASPM Level:\nForce L1 - Force all links to L1 State\nAUTO - BIOS auto configure\nDISABLE - Disables ASPM.

Detect Non-Compliance Device

Detect Non-Compliance PCI Express Device. If enabled, it will take more time at POST time.

- **HD Audio Configuration**

This screen shows HD Audio information

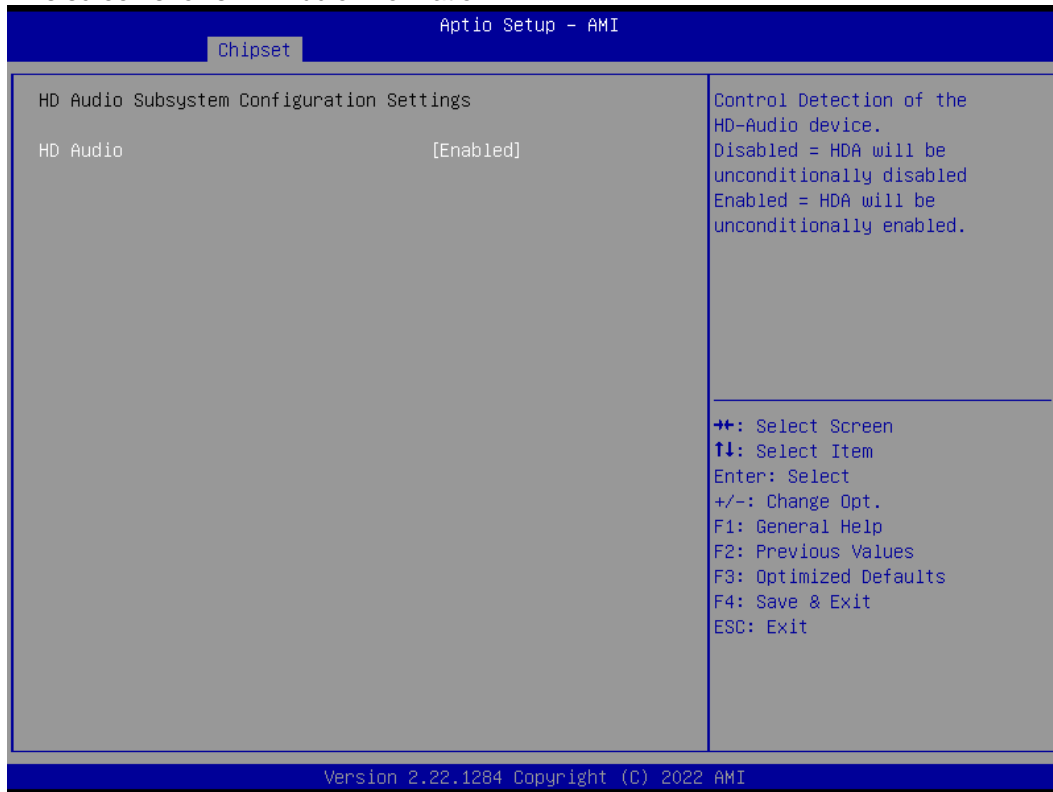

4.6 Security Menu

The Security menu allows users to change the security settings for the system.

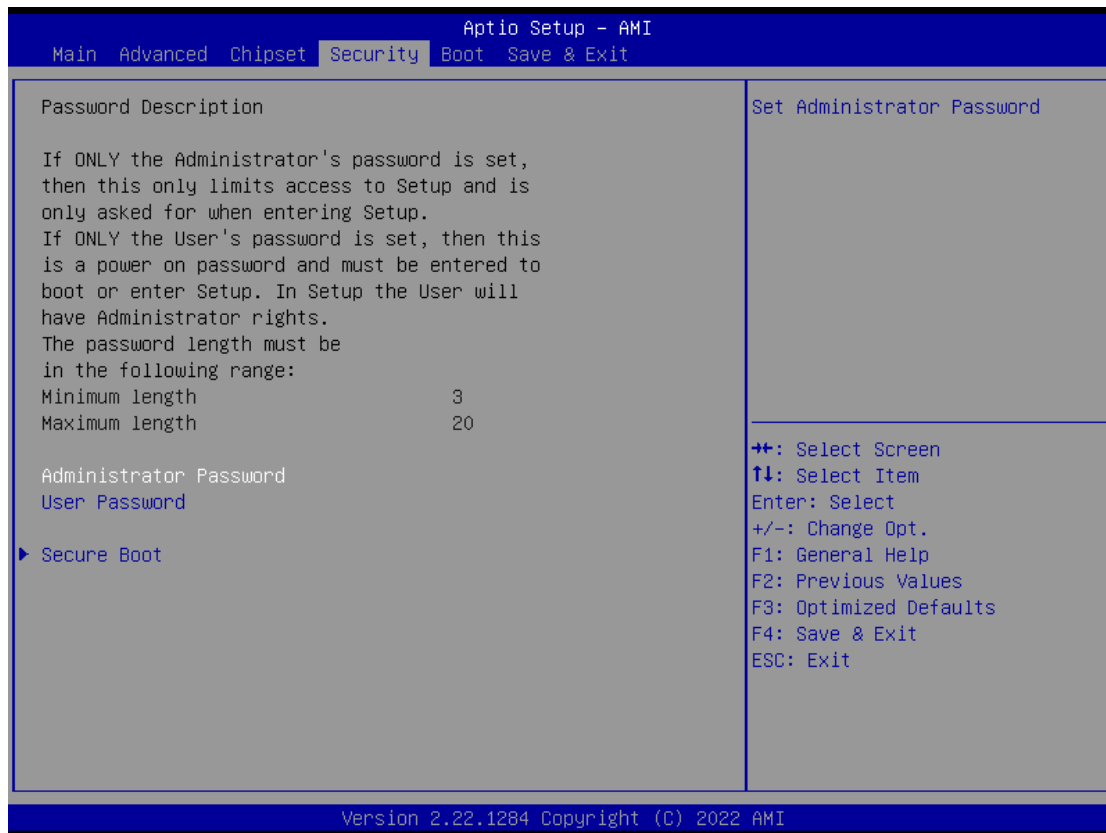

- **Administrator Password**
This item indicates whether an administrator password has been set (installed or uninstalled).
- **User Password**
This item indicates whether a user password has been set (installed or uninstalled).
- **Secure Boot**
This item is available on the UEFI firmware to provide a secure environment.

4.7 Boot Menu

The Boot menu allows users to change boot options of the system.

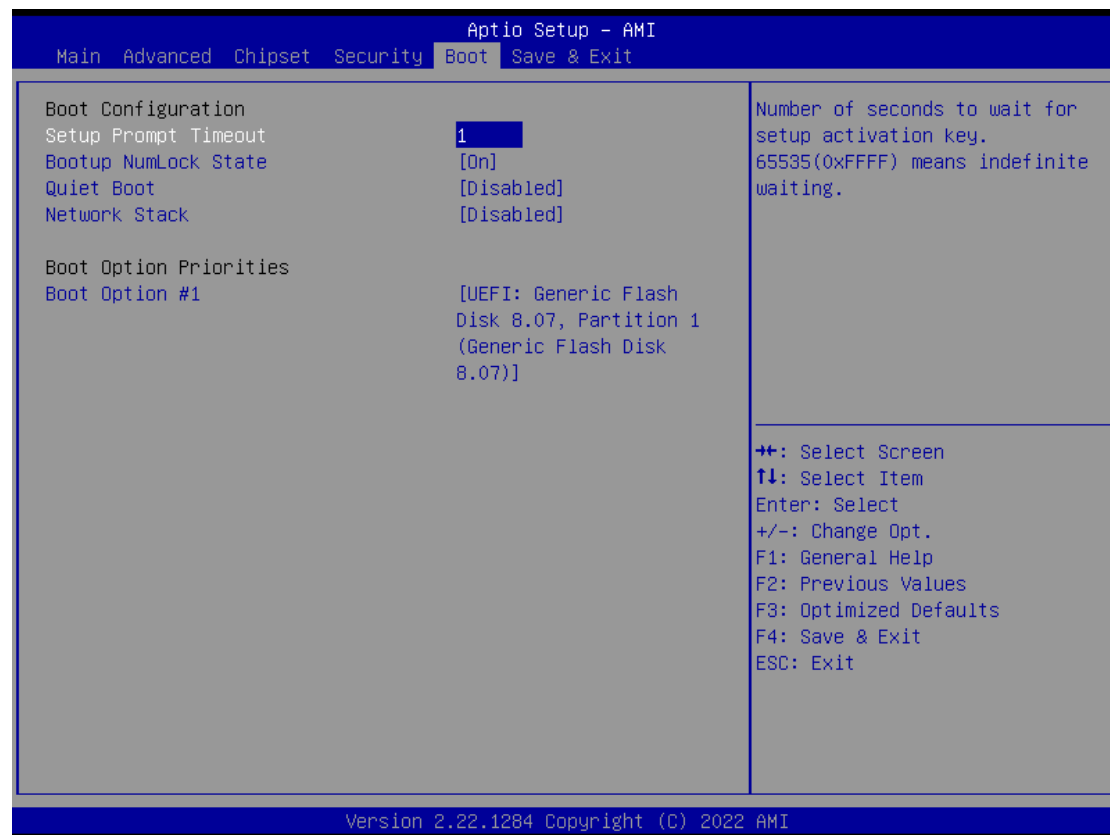

- Setup Prompt Timeout**
 Number of seconds to wait for setup activation key. 65535(0xFFFF) means indefinite waiting.
- Bootup NumLock State**
 Use this item to select the power-on state for the keyboard NumLock.
- Quiet Boot**
 Select to display either POST output messages or a splash screen during boot-up.
- Network Stack**
 Use this item to run the BIOS of your device through the internet instead of Hard Drives
- Boot Option Priorities**
 These are settings for boot priority. Specify the boot device priority sequence from the available devices.

4.8 Save & Exit Menu

The Save & Exit menu allows users to load your system configuration with optimal or fail-safe default values.

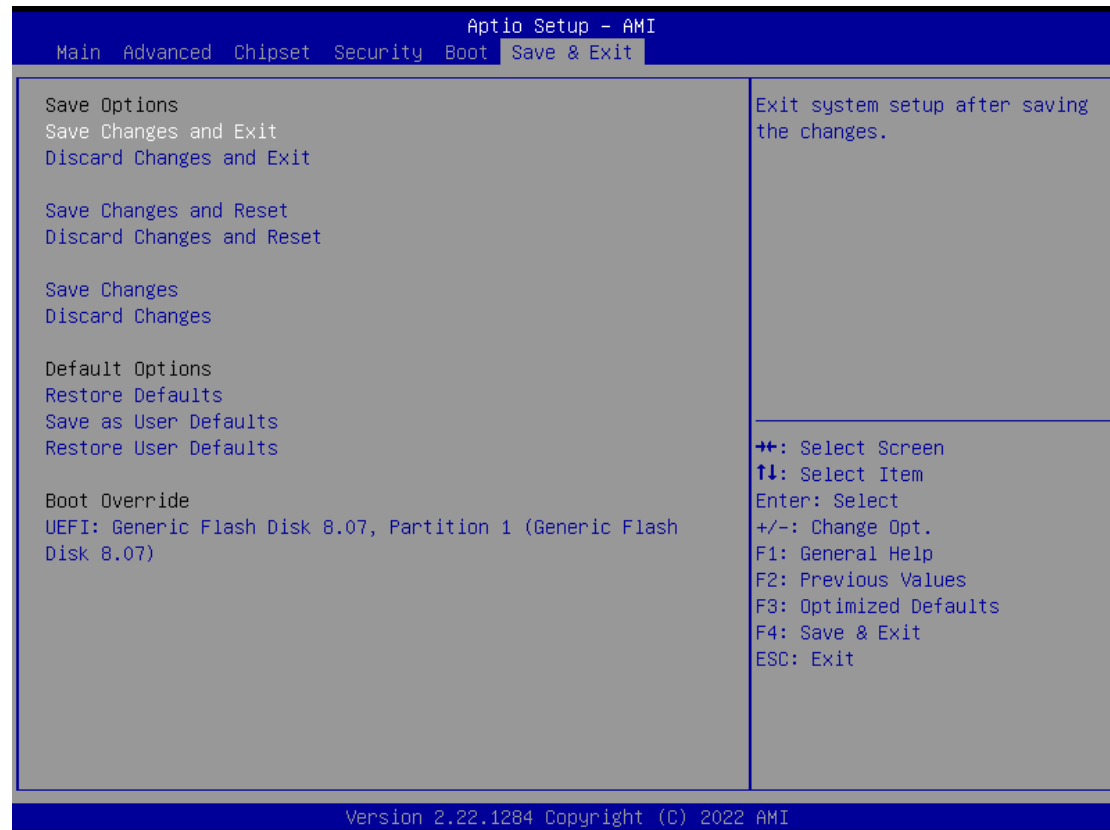

- Save Changes and Exit**
 When you have completed the system configuration changes, select this option to leave Setup and return to Main Menu. Select Save Changes and Exit from the Save & Exit menu and press <Enter>. Select Yes to save changes and exit.
- Discard Changes and Exit**
 Select this option to quit Setup without making any permanent changes to the system configuration and return to Main Menu. Select Discard Changes and Exit from the Save & Exit menu and press <Enter>. Select Yes to discard changes and exit.
- Save Changes and Reset**
 When you have completed the system configuration changes, select this option to leave Setup and reboot the computer so the new system configuration parameters can take effect. Select Save Changes and Reset from the Save & Exit menu and press <Enter>. Select Yes to save changes and reset.
- Discard Changes and Reset**
 Select this option to quit Setup without making any permanent changes to the system configuration and reboot the computer. Select Discard Changes and Reset from the Save & Exit menu and press <Enter>. Select Yes to discard changes and reset.

- **Save Changes**
When you have completed the system configuration changes, select this option to save changes. Select Save Changes from the Save & Exit menu and press <Enter>. Select Yes to save changes.
- **Discard Changes**
Select this option to quit Setup without making any permanent changes to the system configuration. Select Discard Changes from the Save & Exit menu and press <Enter>. Select Yes to discard changes.
- **Restore Defaults**
It automatically sets all Setup options to a complete set of default settings when you select this option. Select Restore Defaults from the Save & Exit menu and press <Enter>.
- **Save as User Defaults**
Select this option to save system configuration changes done so far as User Defaults. Select Save as User Defaults from the Save & Exit menu and press <Enter>.
- **Restore User Defaults**
It automatically sets all Setup options to a complete set of User Defaults when you select this option. Select Restore User Defaults from the Save & Exit menu and press <Enter>.
- **Boot Override**
Select a drive to immediately boot that device regardless of the current boot order.

Appendix A

TPM Module Installation

The TPM 2.0 (Trusted Platform Module 2.0) module is a modularized design applying to the IMB540 and provides enhanced hardware security for the computer. In this appendix you will learn how to install the TPM 2.0 module into the IMB540. Please read and follow the instructions below carefully.

1. Insert TPM module into the SPI interface of motherboard, as illustrated below.

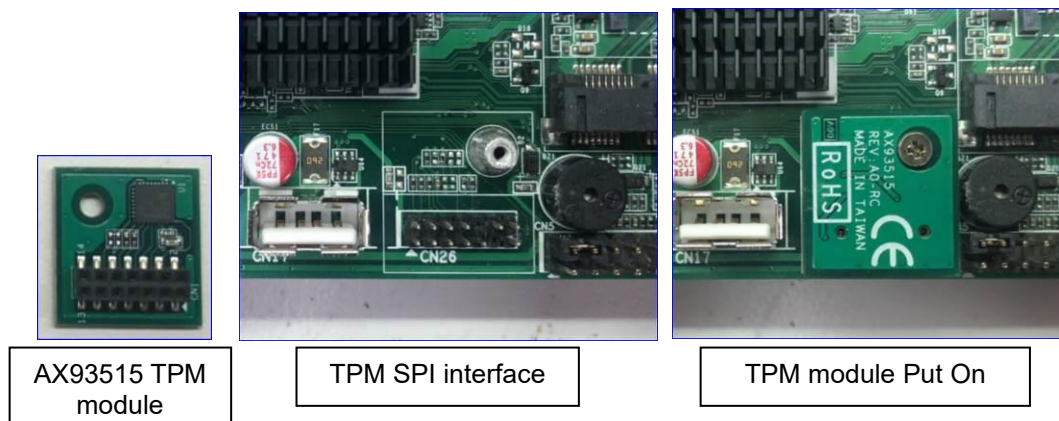

2. There are two ways to confirm whether the TPM Module is installed successfully or not:
 - a. Enter the BIOS setup menu and go to Trusted Computing. On the first line it will show "TPM2.0 Device Found".



(In the Advance menu, go to Trusted Computing)



(In the Trusted Computing section, on the first of line it will show “TPM2.0 Device Found”, if installation is successful.)

- b. In the Windows 10 OS environment, enter Device Manager, and select Security devices. The screen will show “Trusted Platform Module 2.0” if installation is successful.

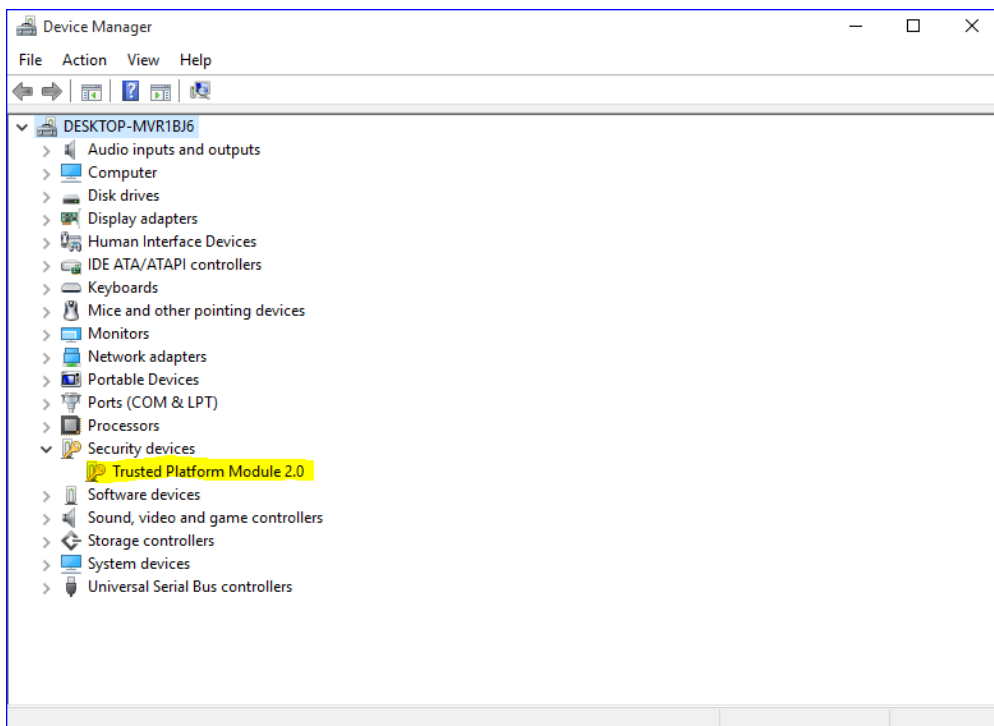

- c. In the Windows 10 OS environment, enter Control Panel, select BitLocker Drive Encryption, and enter TPM Administration. The screen will show the information below if installation is successful.

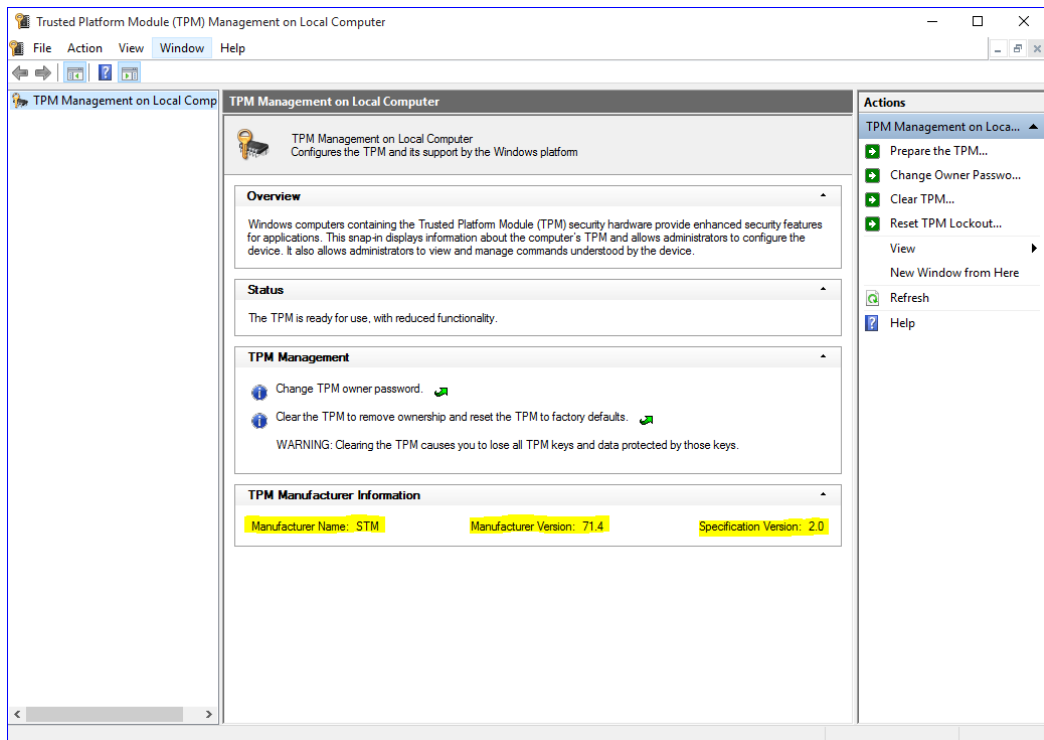

This page is intentionally left blank.

Appendix B

iAMT Settings

The Intel® Active Management Technology (Intel® AMT) utilizes built-in platform capabilities and popular third-party management and security applications to allow IT administrators to remotely discover, repair and better protect their networked computing assets, thus significantly improving IT management efficiency.

In order to use Intel® AMT you must enter the ME BIOS (<Ctrl + Alt + F1> during system startup), change the ME BIOS password, and then select “Intel® iAMT” as the manageability feature.

Entering Management Engine BIOS Extension (MEBx)

1. Go to BIOS to enable the iAMT function.
2. After restarting BIOS, exit and enter MEBx Setting.

Set and Change Password

1. You will be asked to set a password at first login. The default password is “admin”.
2. You will be asked to change the password before setting ME.
3. Confirm your new password while revising. The new password must consist of eight characters, including at least:
 - One upper case letter
 - One lower case letter
 - One number
 - One special symbol, such as '!', '\$', ';' (except: ':', ',', '"')

The default demonstrates an example of a valid password: **!!11qqQQ**

Underline and space are valid characters for the password.

iAMT Settings

1. Select Intel® AMT configuration and press <Enter>.

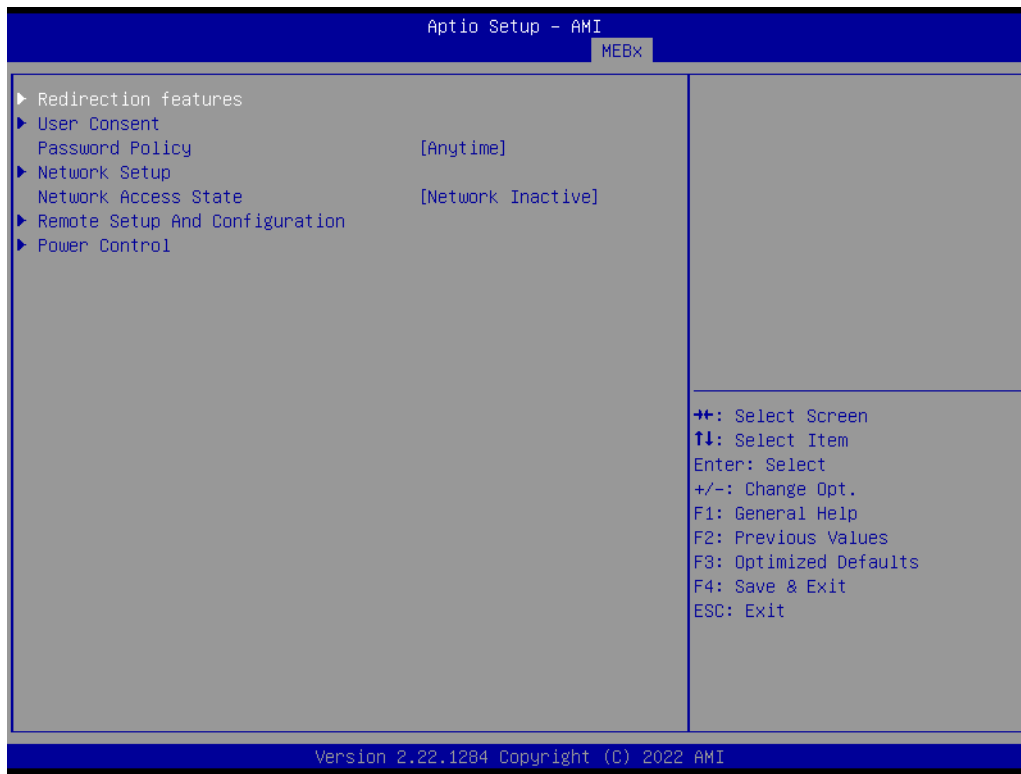

2. Select Network Setup to configure iAMT.

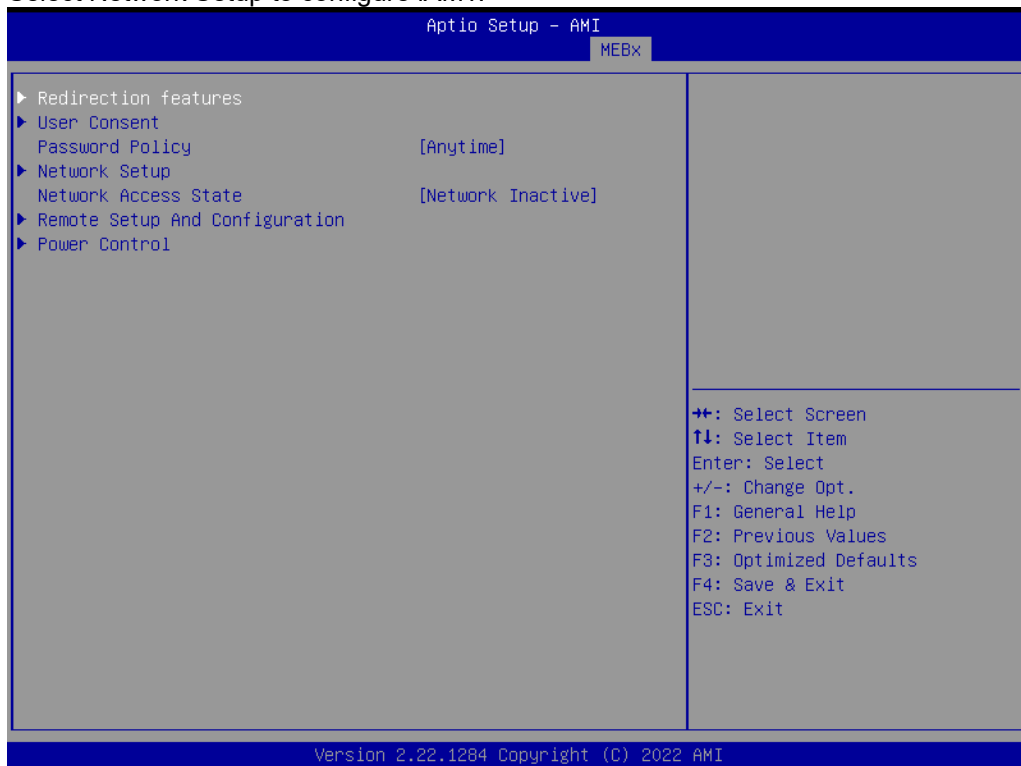

- Go back to Intel® AMT Configuration, then select Activate Network Access and press <Enter>.

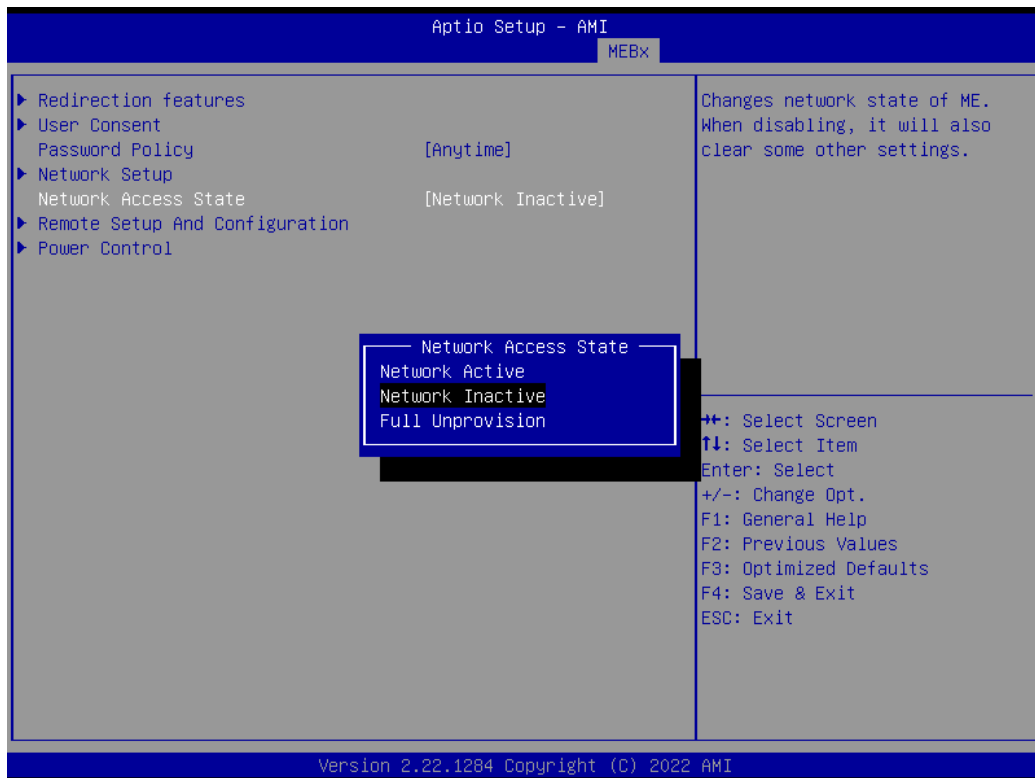

- Exit from MEBx after completing the iAMT settings.

iAMT Web Console

1. On a web browser, type [http://\(IP ADDRESS\):16992](http://(IP ADDRESS):16992), which connects to iAMT Web.

Example: <http://10.1.40.214:16992>

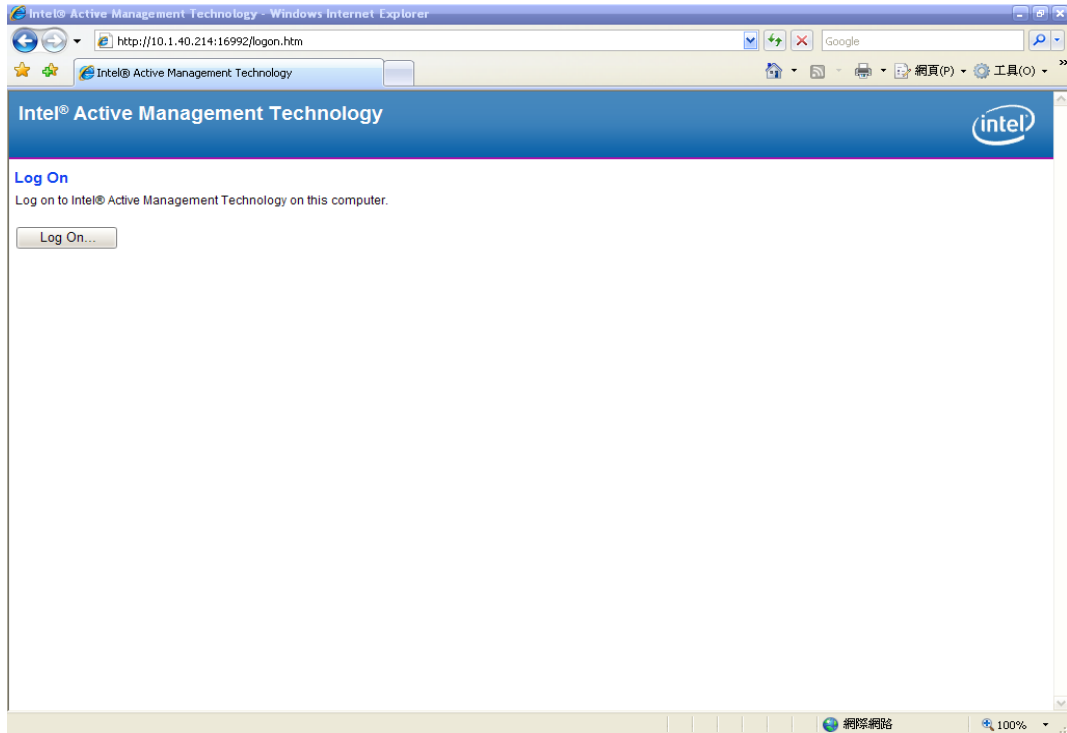

2. To log on, you will be required to type in your username and password for access to the Web.

USER: admin (default)
PASS: (MEBx password)

3. Enter the iAMT Web.

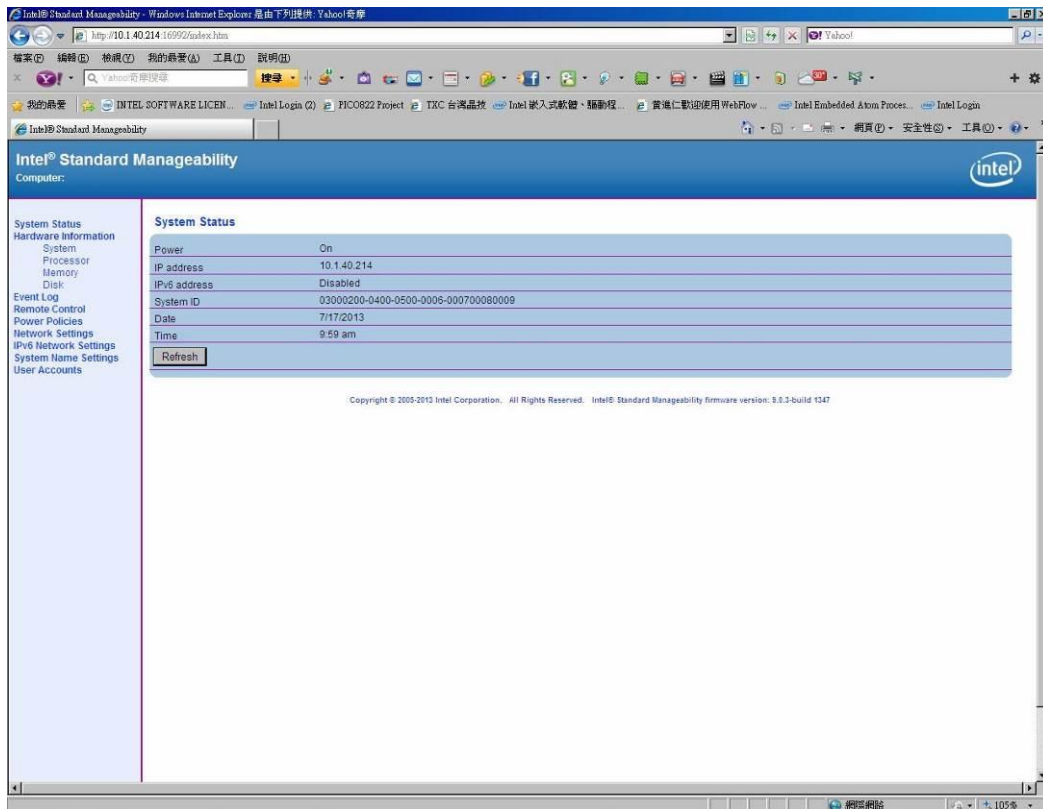

4. Click Remote Control, and select commands on the right side.

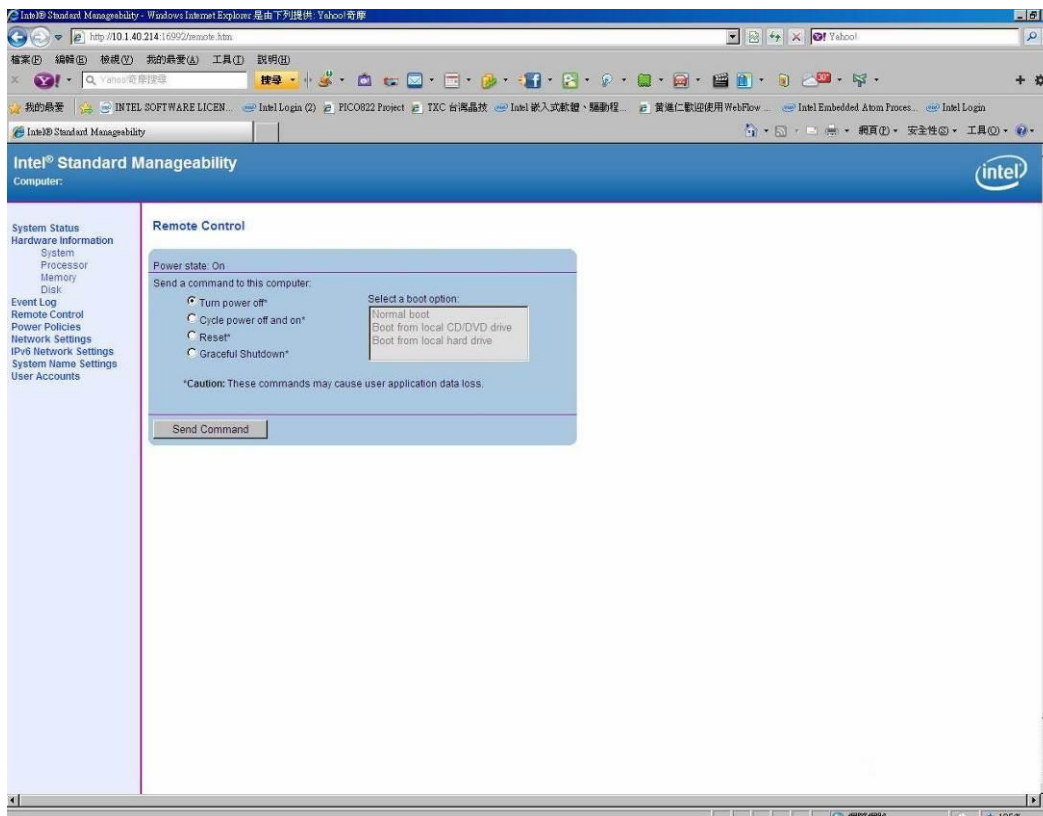

5. When you have finished using the iAMT Web console, close the Web browser.

Appendix C

Digital I/O

Digital I/O Software Programming

- I2C to GPIO PCA9554PW GPIO[3:0] is Output, GPIO[7:4] is Input.
- I2C address: 0b0100100x.
- IOBASE: 0xF040
- Registers:

Command byte

Command	Protocol	Function
0	Read byte	Input port register
1	Read/write byte	Output port register
2	Read/write byte	Polarity inversion register
3	Read/write byte	Configuration register

The command byte is the first byte to follow the address byte during a write transmission. It is used as a pointer to determine which of the following registers will be written or read.

Register 0: Input port register.

This register is a read-only port. It reflects the incoming logic levels of the pins, regardless of whether the pin is defined as an input or an output by Register 3. Writes to this register have no effect.

The default 'X' is determined by the externally applied logic level, normally '1' when no external signal is externally applied because of the internal pull-up resistors.

Bit	Symbol	Access	Value	Description
7	I7	Read only	X	Determined by externally applied logic level.
6	I6	Read only	X	
5	I5	Read only	X	
4	I4	Read only	X	
3	I3	Read only	X	
2	I2	Read only	X	
1	I1	Read only	X	
0	I0	Read only	X	

Register 1: Output port register.

This register reflects the outgoing logic levels of the pins defined as outputs by Register 3. Bit values in this register have no effect on pins defined as inputs. Reads from this register return the value that is in the flip-flop controlling the output selection, not the actual pin value.

Bit	Symbol	Access	Value	Description
7	O7	R	1*	Reflects outgoing logic levels of pins defined as outputs by Register 3.
6	O6	R	1*	
5	O5	R	1*	
4	O4	R	1*	
3	O3	R	1*	
2	O2	R	1*	
1	O1	R	1*	
0	O0	R	1*	

* : Default value

Register 2: Configuration register.

This register configures the directions of the I/O pins. If a bit in this register is set, the corresponding port pin is enabled as an input with a high-impedance output driver. If a bit in this register is cleared, the corresponding port pin is enabled as an output. At reset, the I/Os are configured as inputs with a weak pull-up to VDD.

Bit	Symbol	Access	Value	Description
7	C7	R/W	1*	Configure the directions of the I/O pins. 0 = Corresponding port pin enabled as an output. 1 = Corresponding port pin configured as input (default value).
6	C6	R/W	1*	
5	C5	R/W	1*	
4	C4	R/W	1*	
3	C3	R/W	1*	
2	C2	R/W	1*	
1	C1	R/W	1*	
0	C0	R/W	1*	

* : Default value