

USER'S MANUAL

CAPA322

**Intel® Atom® x6413E and Intel®
Celeron® Processor J6412 and
Celeron® Processor N6210
3.5" Board**

User's Manual



www.axiomtek.com

Disclaimers

This manual has been carefully checked and believed to contain accurate information. Axiomtek Co., Ltd. assumes no responsibility for any infringements of patents or any third party's rights, and any liability arising from such use.

Axiomtek does not warrant or assume any legal liability or responsibility for the accuracy, completeness or usefulness of any information in this document. Axiomtek does not make any commitment to update the information in this manual.

Axiomtek reserves the right to change or revise this document and/or product at any time without notice.

No part of this document may be reproduced, stored in a retrieval system, or transmitted, in any form or by any means, electronic, mechanical, photocopying, recording, or otherwise, without the prior written permission of Axiomtek Co., Ltd.

CAUTION

If you replace wrong batteries, it causes the danger of explosion. It is recommended by the manufacturer that you follow the manufacturer's instructions to only replace the same or equivalent type of battery, and dispose of used ones.

©Copyright 2023 Axiomtek Co., Ltd.

All Rights Reserved

November 2023, Version A3

Printed in Taiwan

ESD Precautions

Computer boards have integrated circuits sensitive to static electricity. To prevent chipsets from electrostatic discharge damage, please take care of the following jobs with precautions:

- Do not remove boards or integrated circuits from their anti-static packaging until you are ready to install them.
- Before holding the board or integrated circuit, touch an unpainted portion of the system unit chassis for a few seconds. It discharges static electricity from your body.
- Wear a wrist-grounding strap, available from most electronic component stores, when handling boards and components.

Trademarks Acknowledgments

Axiomtek is a trademark of Axiomtek Co., Ltd.

Intel® and Celeron® are trademarks of Intel Corporation.

Windows® is a trademark of Microsoft Corporation.

AMI is a trademark of American Megatrend Inc.

IBM, PC/AT, PS/2, VGA are trademarks of International Business Machines Corporation.

Other brand names and trademarks are the properties and registered brands of their respective owners.

Table of Contents

Disclaimers.....	ii
ESD Precautions.....	iii
Section 1 Introduction.....	1
1.1 Features.....	2
1.2 Specifications.....	2
1.3 Utilities Supported.....	3
Section 2 Board and Pin Assignments.....	5
2.1 Board Dimensions and Fixing Holes.....	5
2.2 Board Layout.....	7
2.3 Jumper and Switch Settings.....	9
2.3.1 LVDS/eDP +3.3V/+5V/+12V Voltage Selection (JP1).....	10
2.3.2 Restore BIOS Optimal Defaults (SW1).....	10
2.3.3 Auto Power On (SSW1).....	10
2.4 Connectors.....	11
2.4.1 I ² C Connector (CN1).....	12
2.4.2 Fan Connector (CN2).....	12
2.4.3 Front Panel Connector (CN3).....	13
2.4.4 LVDS Connector (CN4).....	14
2.4.5 HD Audio Wafer Connector (CN5).....	16
2.4.6 Inverter Connector (CN6).....	16
2.4.7 Digital I/O Wafer Connector (CN7).....	17
2.4.8 SATA Power Connector (CN8).....	17
2.4.9 eDP Connector (CN9) (Optional).....	18
2.4.10 SIM Card Wafer Connector (CN10).....	18
2.4.11 DisplayPort++ Connector (CN11).....	19
2.4.12 HDMI Connector (CN12).....	19
2.4.13 ATX Power Connector (ATX1/ATX2).....	20
2.4.14 CMOS Battery Connector (BAT1).....	20
2.4.15 COM Wafer Connectors (COM1~COM4).....	21
2.4.16 Ethernet Ports (LAN1 and LAN2).....	22
2.4.17 SATA Connector (SATA1).....	23
2.4.18 USB 2.0 Wafer Connector (USB1).....	23
2.4.19 USB 3.2 Gen2 Type A Port (USB2).....	23
2.4.20 USB 2.0 Type A Port (USB3).....	24
2.4.21 M.2 Key E Connector (SCN2).....	25
2.4.22 Full-size PCI-Express Mini Card Connector (SCN3).....	26
2.4.23 M.2 Key B Connector (SCN4).....	27

Section 3	Hardware Description	29
3.1	Microprocessors	29
3.2	BIOS	29
3.3	System Memory.....	29
3.4	I/O Port Address Map.....	30
3.5	Interrupt Controller (IRQ) Map	31
3.6	Memory Map	36
Section 4	AMI BIOS Setup Utility	37
4.1	Starting.....	37
4.2	Navigation Keys	37
4.3	Main Menu.....	39
4.4	Advanced Menu.....	40
4.5	Chipset Menu.....	52
4.6	Security Menu.....	54
4.7	Boot Menu.....	56
4.8	Save & Exit Menu	57
Appendix A	Watchdog Timer.....	59
A.1	About Watchdog Timer	59
A.2	How to Use Watchdog Timer.....	59
Appendix B	Digital I/O	61
B.1	About Digital I/O	61
B.2	Digital I/O Programming	61

This page is intentionally left blank.

Section 1

Introduction

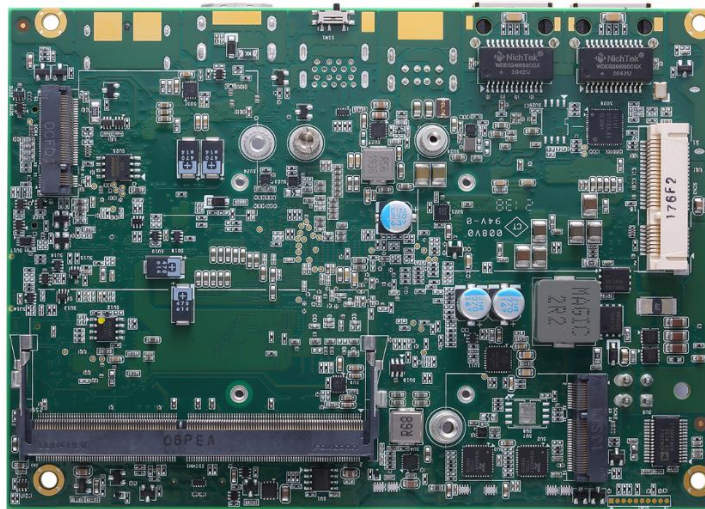
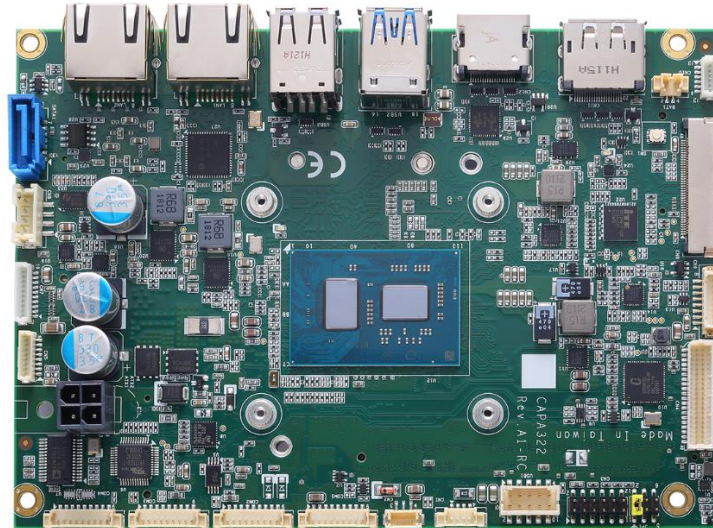

The CAPA322 is a 3.5" embedded board with Intel® Celeron® processor J6412 and N6210 & Atom® x6413E processor that deliver outstanding system performance through high-bandwidth interfaces, multiple I/O functions for interactive applications and various embedded computing solutions.

It has one 260-pin unbuffered SO-DIMM socket for single channel DDR4 3200MHz memory with maximum memory capacity up to 32GB. There are two 2.5 Gigabit Ethernet, one SATA port with transfer rate up to 6Gb/s, two USB 3.2 Gen2 ports, and four USB 2.0 ports that can achieve the best stability and reliability for industrial applications. Additionally, it provides you with unique embedded features, such as four serial ports (two RS-232/422/485 and two RS-232) and 3.5" form factor that applies an extensive array of PC peripherals.

1.1 Features

- Intel® Celeron® quad core J6412 processor (2.0GHz) and Celeron® dual core N6210 processor (1.2GHz)
- Intel® Atom® quad core x6413E processor (1.5GHz)
- 1 DDR4 SO-DIMM supports up to 32GB memory capacity
- 2 USB 3.2 Gen2 ports and 4 USB 2.0 ports
- 1 PCI-Express Mini Cards or mSATA
- 1 M.2 Key E and 1 M.2 Key B

1.2 Specifications

- **CPU**
 - Intel® Celeron® quad core J6412 2.0GHz.
 - Intel® Celeron® dual core N6210 1.2GHz.
 - Intel® Atom® quad core x6413E 1.5GHz
- **Thermal Solution**
 - Passive.
- **Operating Temperature**
 - -20°C~+70°C (Celeron processor SKU).
 - -40°C~+80°C (Atom processor SKU).
- **BIOS**
 - American Megatrends Inc. UEFI (Unified Extensible Firmware Interface) BIOS.
 - 256Mbit SPI Flash, DMI, Plug and Play.
 - PXE Ethernet Boot ROM.
- **System Memory**
 - One 260-pin unbuffered DDR4 SO-DIMM socket.
 - Maximum up to 32GB DDR4 3200MHz memory capacity.
- **Onboard Multi I/O**
 - Serial Ports: Two RS-232/422/485 and two RS-232.
- **Storage**
 - One SATA-600 connector.
 - One mSATA.(Please refer to section 2.4.22)
 - One M.2 Key B connector in 22x42 with NVMe supported by PCIe Gen3x2(Please refer to section 2.4.23)
- **USB Interface**
 - Two USB 3.2 Gen2 ports on the rear I/O.
 - Two USB 2.0 ports on the rear I/O.
 - Two USB 2.0 ports in 2x5-pin internal wafer connector.
- **Display**
 - One 2x20-pin connector for 18/24-bit single/dual channel LVDS and one 8-pin inverter connector. LVDS resolution is up to 1920x1200 in 24-bit dual channels.
 - One HDMI. The resolution is up to 4096x2160 @60Hz.
 - One DisplayPort. The resolution is up to 4096x2160 @60Hz.
 - (Optional, Co-layout with LVDS) One eDP. The resolution is up to 4096x2160 @60Hz.

- **Trusted Platform Module (TPM)**
 - Controller: ST ST33HTPH2X32AHD8 via SPI bus interface.
 - Complies with TPM2.0 main and PC client specification.
- **Watchdog Timer**
 - Timeout value range is 1~65535 seconds.
- **Ethernet**
 - Two RJ-45 LAN port: Intel® I225-V supports 2500/1000/100/10Mbps Gigabit/Fast Ethernet with Wake-on-LAN and PXE Boot ROM.
- **Audio**
 - HD audio link without codec.
- **Expansion Interface**
 - One full-size PCI-Express Mini Card complies with PCI-Express Mini Card Spec. V1.2. (Please refer to section 2.4.22)
 - One M.2 Key E connector in 22x30.
 - One M.2 Key B connector in 30x42 and 30x52. (Please refer to section 2.4.23)
- **Power Input**
 - One 2x2-pin connector.
 - +12V to +24V DC-in only.
 - Auto power on function supported.
- **Power Management**
 - ACPI (Advanced Configuration and Power Interface).
- **Form Factor**
 - 3.5" form factor.



All specifications and images are subject to change without notice.

Note

1.3 Utilities Supported

- Chipset and graphics driver
- Ethernet driver
- Management Engine

This page is intentionally left blank.

Section 2

Board and Pin Assignments

2.1 Board Dimensions and Fixing Holes

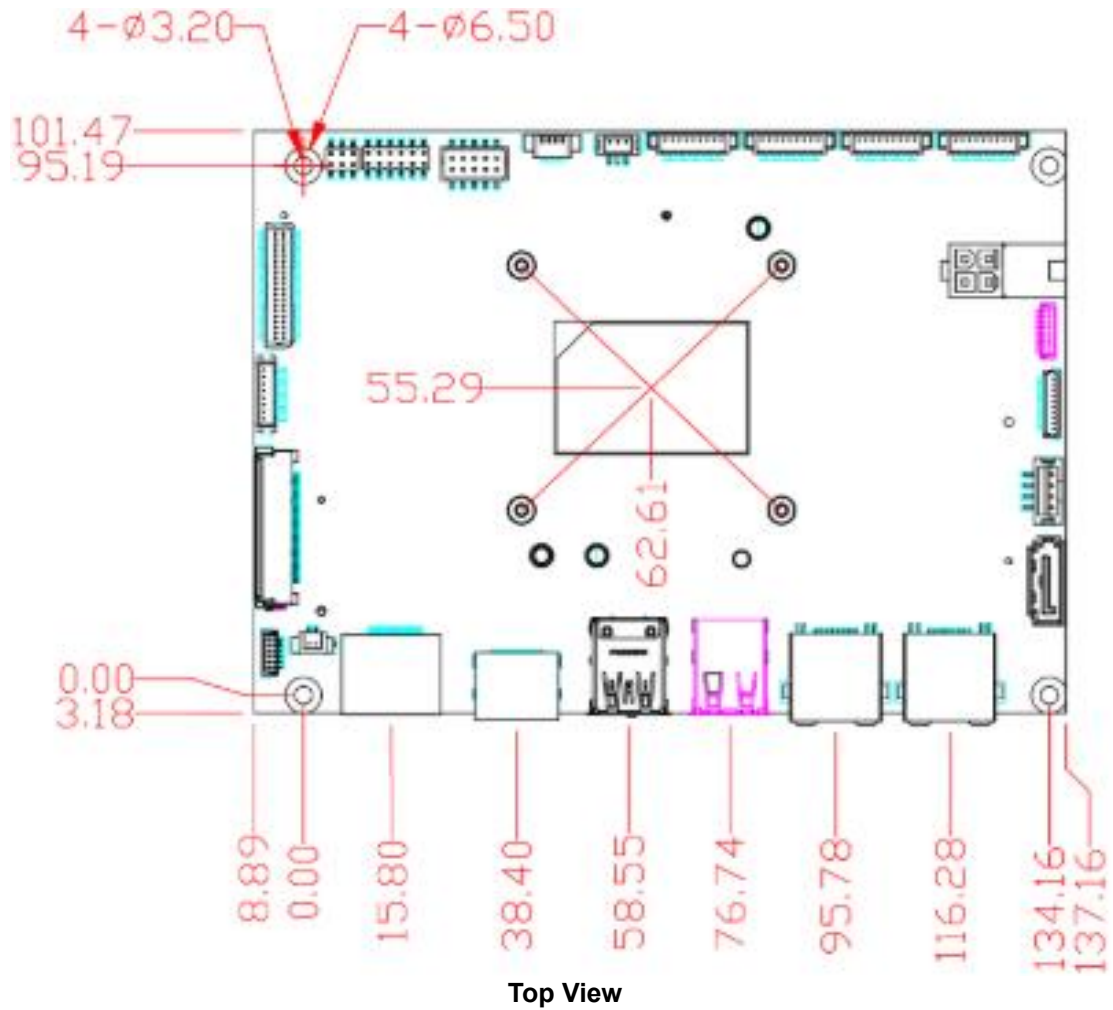

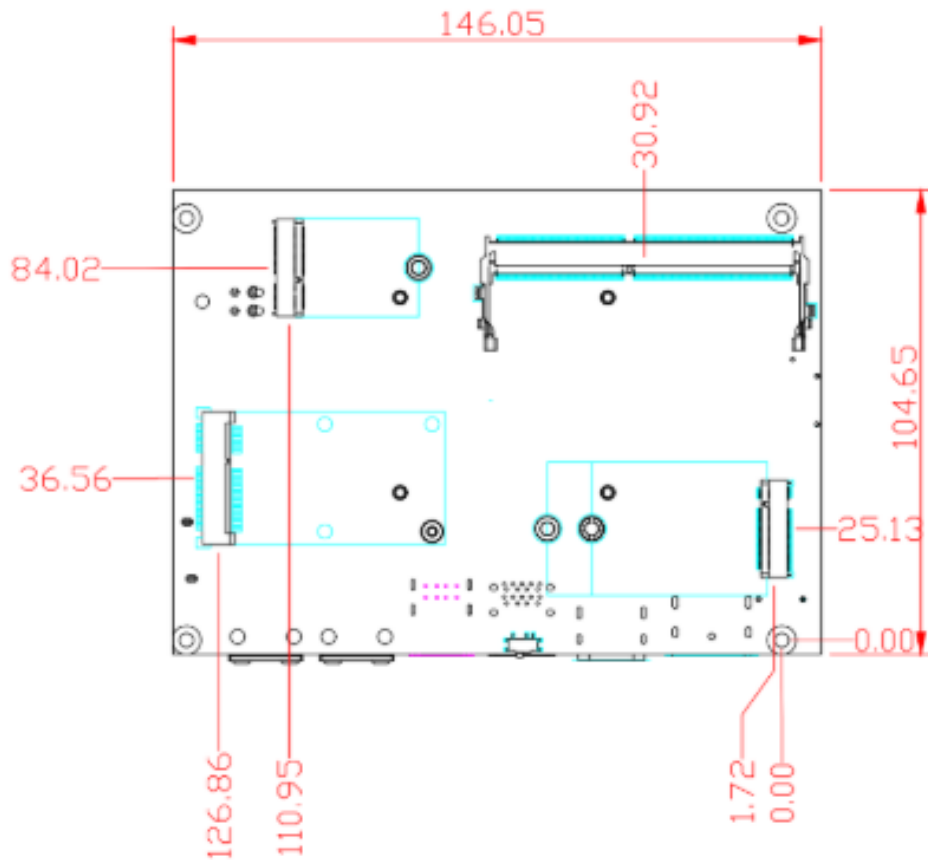

Bottom View

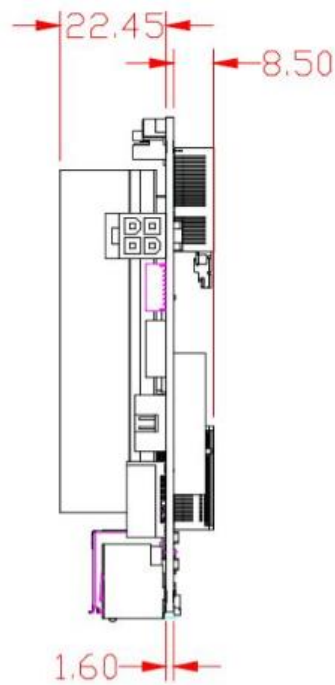

Side View

2.2 Board Layout

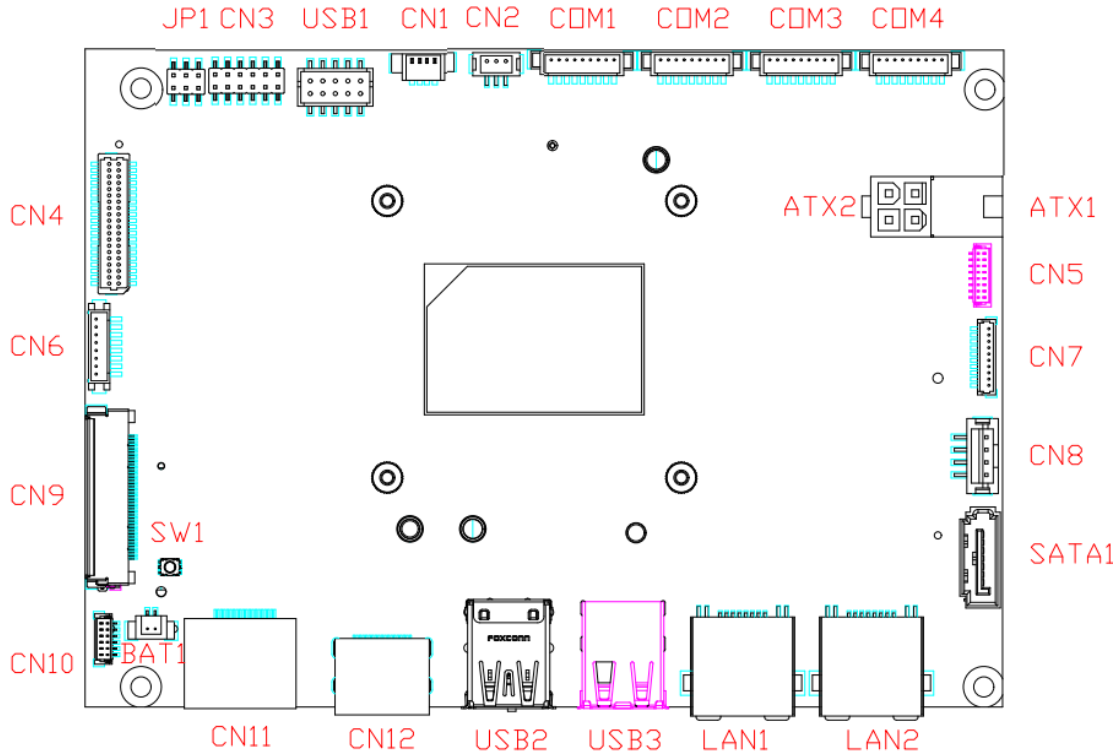

Top View

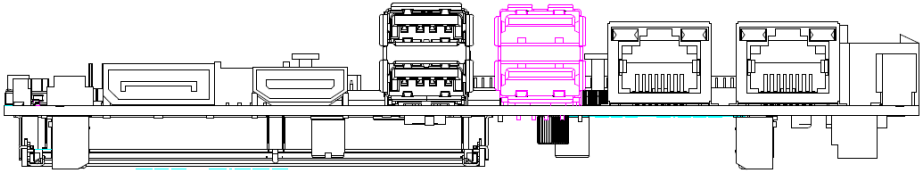

Side View

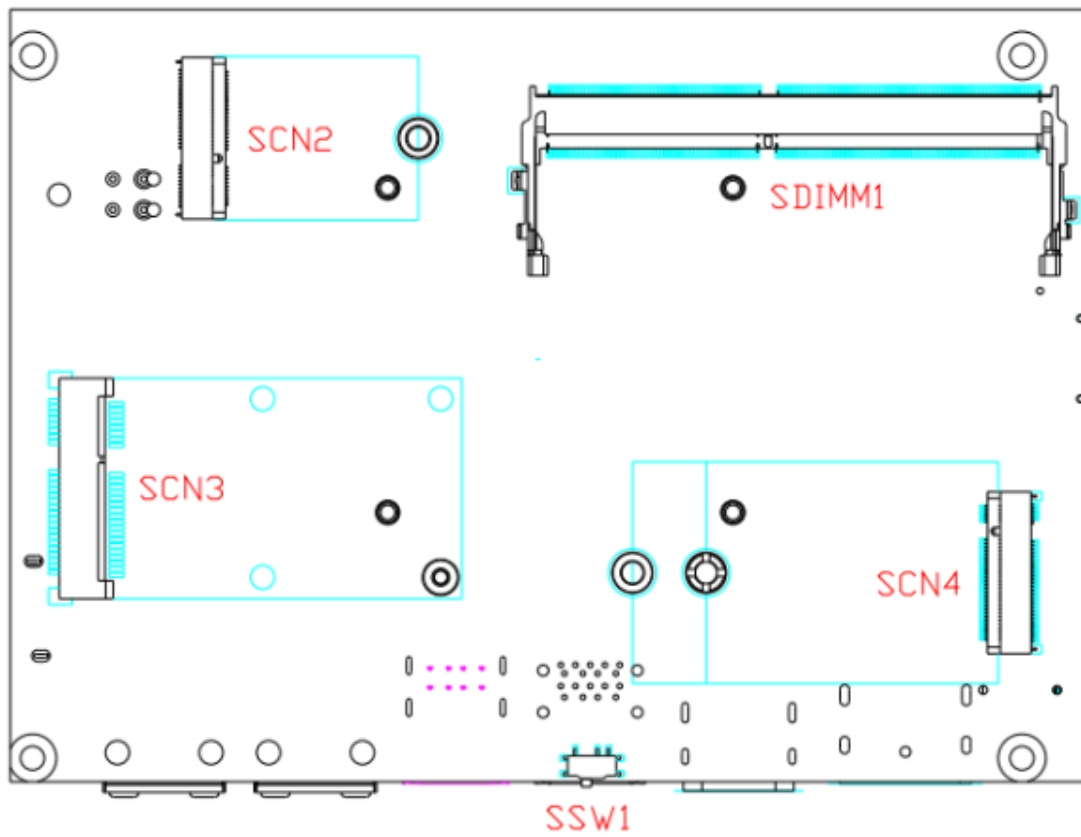

Bottom View

2.3 Jumper and Switch Settings

Jumper is a small component consisting of jumper clip and jumper pins. Install jumper clip on 2 jumper pins to close. And remove jumper clip from 2 jumper pins to open. Below illustration shows how to set up jumper.

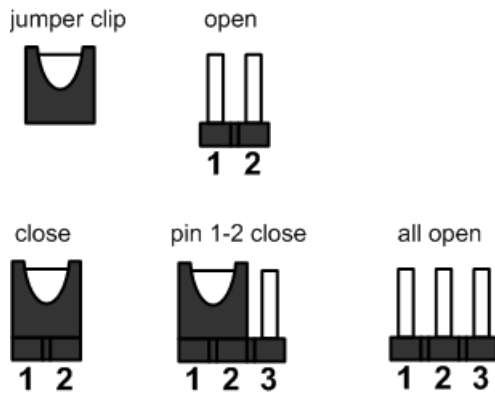

Properly configure jumper and switch settings on the CAPA322 to meet your application purpose. Below you can find a summary table of jumpers, switch and onboard default settings.



Note

Once the default jumper or switch setting needs to be changed, please do it under power-off condition.

Jumper and Switch	Description	Setting
JP1	LVDS/eDP +3.3V/+5V/+12V Voltage Selection Default: +3.3V	1-2 Close
SW1	Restore BIOS Optimal Defaults Default: Normal Operation	Release
SSW1	Auto Power On Default: Disable	1-2 Close

2.3.1 LVDS/eDP +3.3V/+5V/+12V Voltage Selection (JP1)

The board supports voltage selection for flat panel displays. Use this jumper to set LVDS connector (CN4) pin 1~6 VCCM / eDP connector (CN9) pin 1~4 LCD_VCC to +3.3V, +5V or +12V level. To prevent hardware damage, before connecting please make sure that the input voltage of flat panel is correct.

Function	Setting
+12V level	5-6 close
+5V level	2-4 close or 4-6 close
+3.3V level (Default)	1-2 close



2.3.2 Restore BIOS Optimal Defaults (SW1)

Use SW1 to restore CMOS. To restore BIOS optimal defaults, press the tact switch for at least 3 seconds, then release.

Function	Setting
Normal (Default)	Release
Restore BIOS optimal defaults	Press

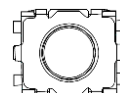

2.3.3 Auto Power On (SSW1)

If SSW1 is enabled for power input, the system will be automatically power on without pressing soft power button. If SSW1 is disabled for power input, it is necessary to manually press soft power button to power on the system.

Function	Setting
Disable auto power on (Default)	1-2 close
Enable auto power on	2-3 close

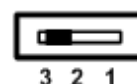

2.4 Connectors

Signals go to other parts of the system through connectors. Loose or improper connection might cause problems, please make sure all connectors are properly and firmly connected. Here is a summary table of connectors on the hardware.

Connector	Description
CN1	I ² C Connector
CN2	Fan Connector
CN3	Front Panel Connector
CN4	LVDS Connector
CN5	HD Audio Wafer Connector (Compatible with AX93A22)
CN6	Inverter Connector
CN7	Digital I/O Wafer Connector
CN8	SATA Power Connector
CN9 (Optional)	eDP Connector
CN10	SIM Card Wafer Connector (Compatible with AX93A19)
CN11	DisplayPort++ Connector
CN12	HDMI Connector
ATX1 (Optional)	ATX 90D Power Connector (Co-lay)
ATX2	ATX 180D Power Connector
BAT1	CMOS Battery Connector
COM1~COM2	COM1~COM2 Wafer Connectors (Support RS232/422/485)
COM3~COM4	COM3~COM4 Wafer Connectors (Support RS232)
LAN1~2	Ethernet Port
SATA1	SATA Connector
USB1	USB 2.0 Wafer Port 4 and 5
USB2	USB 3.2 Gen2 Type A Port
USB3	USB 2.0 Type A Port
SCN2	M.2 Key E Connector
SCN3	Full-size PCI-Express Mini Card Connector
SCN4	M.2 Key B Connector
SDIMM1	DDR4 SO-DIMM Connector

2.4.1 I²C Connector (CN1)

This is a 4-pin (pitch=1.25mm) connector for I²C interface which is compatible with SMBus.

Pin	Signal
1	I ² C _CLK
2	I ² C _DATD
3	I ² C _ALERT_N
4	GND



2.4.2 Fan Connector (CN2)

Cooling fan interface is available through this connector. You can find fan speed within BIOS Setup Utility if fan is installed. For further information, see BIOS Setup Utility: Advanced\Hardware Monitor\PC Health Status (see section 4.4).

Pin	Signal
1	GND
2	+12V level
3	Fan speed feedback

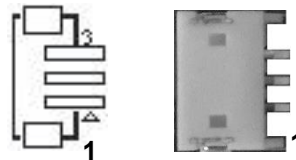

2.4.3 Front Panel Connector (CN3)

This is a 2x6-pin header (pitch=2.0mm) for front panel interface.

Pin	Signal	Pin	Signal
1	BUZZER-	2	BUZZER+
3	GND	4	PWR_PSON
5	PWRLED-	6	PWRLED+
7	PWRSW-	8	PWRSW+
9	HW RST-	10	HW RST+
11	HDDLED-	12	HDDLED+

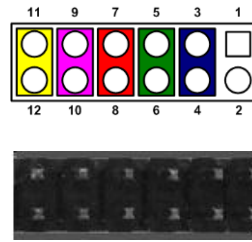

Internal Buzzer

Pin 1(-) and 2(+) connect the internal buzzer cable.

Power Status (PS-ON)

Pin 4 and pin 3 are PS-ON signal which are connected for knowing the power status of this board.

Power LED

Pin 6 connects anode (+) of LED and pin 5 connects cathode(-) of LED. The power LED lights up when the system is powered on.

Power On/Off Button

Pin 7 and 8 connect the power button on front panel to CPU board, which allows users to turn on or off power supply.

System Reset Switch

Pin 9 and 10 connect the case-mounted reset switch that reboots your computer without turning off the power switch. It is a better way to reboot your system for a longer life of system power supply.

HDD Activity LED

This connection is linked to hard drive activity LED on the control panel. LED flashes when HDD is being accessed. Pin 11 and 12 connect the hard disk drive to the front panel HDD LED, pin 11 is assigned as cathode(-) and pin 12 is assigned as anode(+).

2.4.4 LVDS Connector (CN4)

This board has a 2x20-pin connector which is compliant with JST SM40B-SRDS-G-TF for LVDS LCD interface. It is strongly recommended to use the matching connector JST SHDR-40VS-B. Pin 1~6 VCCM can be set to +3.3V, +5V or +12V by setting JP1 (see section 2.3.1).



Note

!: When making LVDS cable, pin 2 of JST SHDR-40VS-B connector should match pin 1 of CN4.

18-bit single channel

Pin	Signal	Pin	Signal
1	VCCM	2	VCCM
3	VCCM	4	VCCM
5	VCCM	6	VCCM
7	N.C.	8	N.C.
9	GND	10	GND
11	N.C.	12	N.C.
13	N.C.	14	N.C.
15	GND	16	GND
17	N.C.	18	N.C.
19	N.C.	20	N.C.
21	GND	22	GND
23	Channel A D0-	24	N.C.
25	Channel A D0+	26	N.C.
27	GND	28	GND
29	Channel A D1-	30	N.C.
31	Channel A D1+	32	N.C.
33	GND	34	GND
35	Channel A D2-	36	Channel A CLK-
37	Channel A D2+	38	Channel A CLK+
39	GND	40	GND

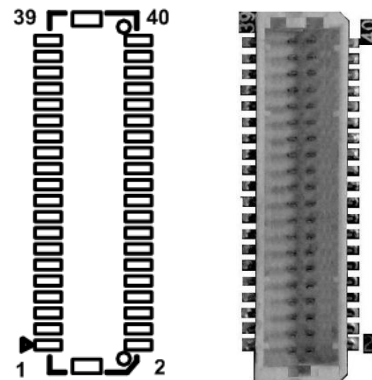

24-bit single channel

Pin	Signal	Pin	Signal
1	VCCM	2	VCCM
3	VCCM	4	VCCM
5	VCCM	6	VCCM
7	N.C	8	N.C
9	GND	10	GND
11	N.C	12	N.C
13	N.C	14	N.C
15	GND	16	GND
17	N.C	18	N.C
19	N.C	20	N.C
21	GND	22	GND
23	Channel A D0-	24	N.C
25	Channel A D0+	26	N.C
27	GND	28	GND
29	Channel A D1-	30	Channel A D3-
31	Channel A D1+	32	Channel A D3+
33	GND	34	GND
35	Channel A D2-	36	Channel A CLK-
37	Channel A D2+	38	Channel A CLK+
39	GND	40	GND

18-bit dual channel

Pin	Signal	Pin	Signal
1	VCCM	2	VCCM
3	VCCM	4	VCCM
5	VCCM	6	VCCM
7	N.C	8	N.C
9	GND	10	GND
11	N.C	12	Channel B D0-
13	N.C	14	Channel B D0+
15	GND	16	GND
17	Channel B CLK-	18	Channel B D1-
19	Channel B CLK+	20	Channel B D1+
21	GND	22	GND
23	Channel A D0-	24	Channel B D2-
25	Channel A D0+	26	Channel B D2+
27	GND	28	GND
29	Channel A D1-	30	N.C
31	Channel A D1+	32	N.C
33	GND	34	GND
35	Channel A D2-	36	Channel A CLK-
37	Channel A D2+	38	Channel A CLK+
39	GND	40	GND

24-bit dual channel

Pin	Signal	Pin	Signal
1	VCCM	2	VCCM
3	VCCM	4	VCCM
5	VCCM	6	VCCM
7	N.C	8	N.C
9	GND	10	GND
11	Channel B D3-	12	Channel B D0-
13	Channel B D3+	14	Channel B D0+
15	GND	16	GND
17	Channel B CLK-	18	Channel B D1-
19	Channel B CLK+	20	Channel B D1+
21	GND	22	GND
23	Channel A D0-	24	Channel B D2-
25	Channel A D0+	26	Channel B D2+
27	GND	28	GND
29	Channel A D1-	30	Channel A D3-
31	Channel A D1+	32	Channel A D3+
33	GND	34	GND
35	Channel A D2-	36	Channel A CLK-
37	Channel A D2+	38	Channel A CLK+
39	GND	40	GND

2.4.5 HD Audio Wafer Connector (CN5)

HD audio interface is available in an 8-pin (pitch=1.0mm) wafer connector fully compliant with JST BM08B-SRSS-TB.

AX93A22 board is suggested to use in order to have Mic in/Line in and Line out.

Pin	Signal
1	+5V_SBY
2	HD_BIT_CLK
3	HD_DATA_IN
4	HD_DATA_OUT
5	HD_SYNC
6	HD_RST#
7	SLP_S3#
8	GND

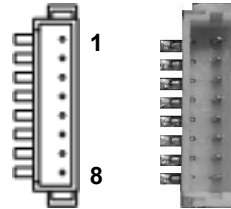

2.4.6 Inverter Connector (CN6)

This is an 8-pin connector fully compliant with Hirose DF13-8P-1.25V for inverter. To avoid malfunction, please use the matching connector DF13-8S-1.25C.

Pin	Signal
1	VBL1 (+12V level)
2	VBL1 (+12V level)
3	VBL2 (+5V level)
4	VBL_ENABLE
5	GND
6	GND
7	GND
8	VBL Brightness Control

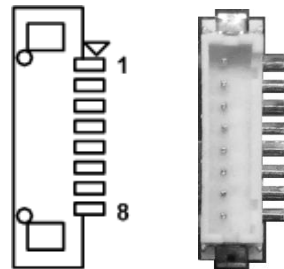

2.4.7 Digital I/O Wafer Connector (CN7)

This is a 1x10-pin (pitch=1.0mm) wafer connector for digital interface which are fully compliant with JST BM10B-SRSS-TB. This 8-bit digital I/O meets requirements for a system customary automation control and can be configured to control cash drawers and sense warning signals from an Uninterrupted Power System (UPS), or perform store security control. You may use software programming to control these digital signals, please refer to Appendix B.

Pin	Signal	Pin	Signal
1	Digital Input 0	2	Digital Output 7
3	Digital Input 1	4	Digital Output 6
5	Digital Input 2	6	Digital Output 5
7	Digital Input 3	8	Digital Output 4
9	+5V	10	GND

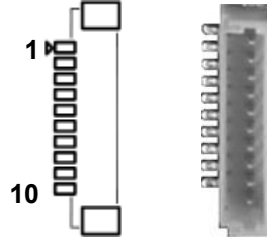

2.4.8 SATA Power Connector (CN8)

This is a 4-pin (pitch=2.0mm) wafer connector fully compliant with JST B4B-PH-K-S.

Pin	Signal
1	+12V level
2	GND
3	GND
4	+5V level

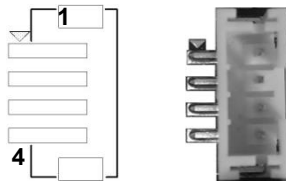

2.4.9 eDP Connector (CN9) (Optional)

The eDP interface is available through 40-pin connector (CN9), which is compliant with IPEX-20143. Pin 1~4 LCD_VCC can be set to +3.3V, +5V or +12V with JP1 (see section 2.3.1).

Pin	Signal	Pin	Signal
1	LCD_VCC	21	TXN0
2	LCD_VCC	22	TXP0
3	LCD_VCC	23	High Speed_GND
4	LCD_VCC	24	AUXP
5	NC	25	AUXN
6	LCD_GND	26	High Speed_GND
7	LCD_GND	27	BKLT_GND
8	LCD_GND	28	BKLT_GND
9	LCD_GND	29	BKLT_GND
10	HPD	30	BKLT_GND
11	High Speed_GND	31	NC
12	TXN3	32	BKLT_CTRL
13	TXP3	33	BKLT_EN
14	High Speed_GND	34	NC
15	TXN2	35	NC
16	TXP2	36	BKLT_VCC_12V
17	High Speed_GND	37	BKLT_VCC_12V
18	TXN1	38	BKLT_VCC_12V
19	TXP1	39	BKLT_VCC_12V
20	High Speed_GND	40	NC

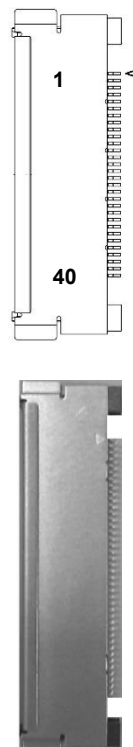

2.4.10 SIM Card Wafer Connector (CN10)

The CN10 is a 6-pin (pitch=1.0mm) wafer connector fully compliant with JST B6B-PH-K-S. AX93A19 SIM I/O board is suggested to use for CN10 to have SIM card slot.

In order to work properly, the SIM card must be used together with 3G/4G/LTE/5G module in either PCI Express Mini card (SCN3) or M.2 Key B connector (SCN4).

Pin	Signal
1	PWR
2	RST
3	CLK
4	I/O
5	VPP
6	GND

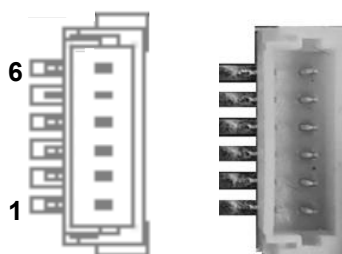

2.4.11 DisplayPort++ Connector (CN11)

The DisplayPort++ interface is available through connector CN15.

Pin	Signal
1	DP_LANE0P
2	GND
3	DP_LANE0_N
4	DP_LANE1_P
5	GND
6	DP_LANE1_N
7	DP_LANE2_P
8	GND
9	DP_LANE2_N
10	DP_LANE3_P
11	GND
12	DP_LANE3_N
13	Detect Pin
14	GND
15	DP_AUX_P
16	GND
17	DP_AUX_N
18	DP_HPDE
19	GND
20	+3.3V

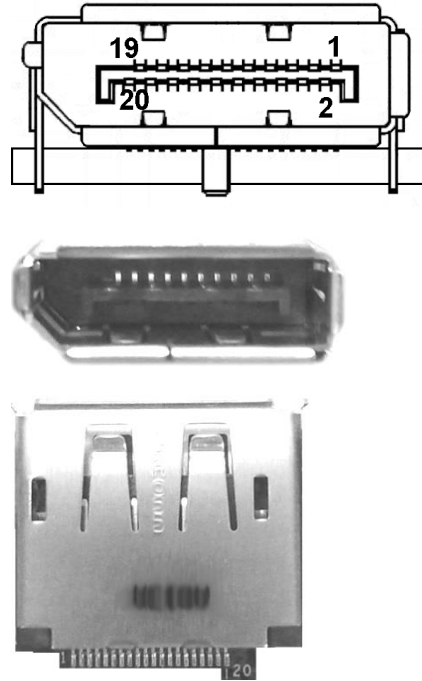

2.4.12 HDMI Connector (CN12)

The HDMI (High-Definition Multimedia Interface) is a compact digital interface which is capable of transmitting high-definition video and high-resolution audio over a single cable.

Pin	Signal	Pin	Signal
1	HDMI OUT_DATA2+	2	GND
3	HDMI OUT_DATA2-	4	HDMI OUT_DATA1+
5	GND	6	HDMI OUT_DATA1-
7	HDMI OUT_DATA0+	8	GND
9	HDMI OUT_DATA0-	10	HDMI OUT_Clock+
11	GND	12	HDMI OUT_Clock-
13	N.C.	14	N.C.
15	HDMI OUT_SCL	16	HDMI OUT_SDA
17	GND	18	+5V
19	HDMI_HTPLG		

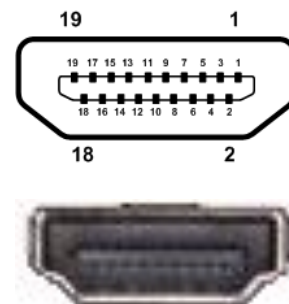

2.4.13 ATX Power Connector (ATX1/ATX2)

Steady and sufficient power can be supplied to all components on the board by connecting the power connector. Please make sure all components and devices are properly installed before connecting the power connector.

The ATX1 is a 90D 4-pin power connector and ATX2 is a 180D 4-pin power connector. Follow the connector orientation to plug the external power supply. Properly press down power supply plug until it completely and firmly fits into this connector. Loose connection may cause system instability. Note that ATX1 is co-lay and BOM optional.

Pin	Signal
1	GND
2	GND
3	DC-In
4	DC-In

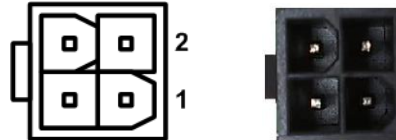

2.4.14 CMOS Battery Connector (BAT1)

This is a 2-pin (pitch=1.25mm) connector for CMOS battery interface.

Pin	Signal
1	BAT1(+3.3V level)
2	GND



2.4.15 COM Wafer Connectors (COM1~COM4)

These are 9-pin (pitch=1.25mm) connectors, compliant with Molex 53047-0910. Use the matching cable 59380880250E is strongly recommended.

- COM1 and COM2 support RS-232/422/485 by BIOS selecting (see section 4.4).
- COM3 and COM4 support RS-232 only

For COM1 and COM2:

Pin	RS-232	RS-422	RS-485
1	DCD	TX-	Data-
2	DSR	No use	No use
3	RXD	TX+	Data+
4	RTS	No use	No use
5	TXD	RX+	No use
6	CTS	No use	No use
7	DTR	RX-	No use
8	RI	No use	No use
9	GND	No use	No use

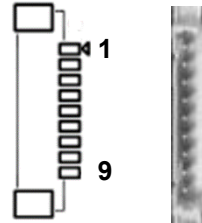

For COM3 and COM4:

Pin	Signal	Pin	Signal
1	DCD	2	DSR
3	RXD	4	RTS
5	TXD	6	CTS
7	DTR	8	RI
9	GND		

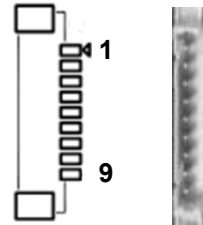

2.4.16 Ethernet Ports (LAN1 and LAN2)

The board has two RJ-45 connectors: LAN1 and LAN2. Connection can be established by plugging one end of the Ethernet cable into

Pin	1000 Base-T	100/10 Base-T	Description
L1	BI_DA+	TX+	Bidirectional or Transmit Data+
L2	BI_DA-	TX-	Bidirectional or Transmit Data-
L3	BI_DB+	RX+	Bidirectional or Receive Data+
L4	BI_DC+	N.C.	Bidirectional or Not Connected
L5	BI_DC-	N.C.	Bidirectional or Not Connected
L6	BI_DB-	RX-	Bidirectional or Receive Data-
L7	BI_DD+	N.C.	Bidirectional or Not Connected
L8	BI_DD-	N.C.	Bidirectional or Not Connected
A	Active Link LED Off: No link Blinking: Data activity detected		
B	Speed LED Green: 2500 Orange: 1000 OFF: 100/10		

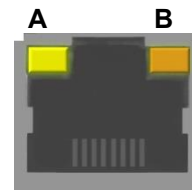
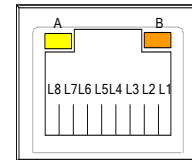

2.4.17 SATA Connector (SATA1)

This is a high-speed SATA (Serial Advanced Technology Attachment or Serial ATA) connector. It is a computer bus interface for connecting to devices such as hard disk drive.

Pin	Signal
1	GND
2	SATA_TX1_P
3	SATA_TX1_N
4	GND
5	SATA_RX1_N
6	SATA_RX1_P
7	GND

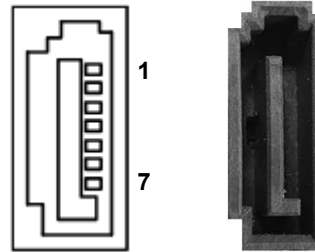

2.4.18 USB 2.0 Wafer Connector (USB1)

The board comes with a Universal Serial Bus (USB) wafer connector for installing versatile USB 2.0 compliant interface peripherals. The USB1 a 2x5-pin (pitch=2.0mm) wafer connector compliant with Hirose DF11-10DP-2DSA.

Pin	Signal	Pin	Signal
1	USB VCC (+5VSB)	2	USB VCC (+5VSB)
3	DN4	4	DN5
5	DP4	6	DP5
7	GND	8	GND
9	GND	10	GND

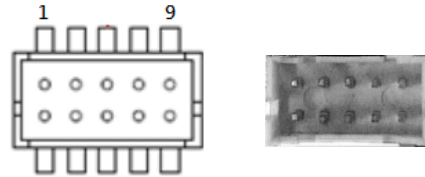

2.4.19 USB 3.2 Gen2 Type A Port (USB2)

The board comes with one Universal Serial Bus (compliant with USB 3.2 Gen 2 (10Gb/s)) ports on the rear I/O for installing USB peripherals such as keyboard, mouse, scanner, etc.

Pin	Signal	Pin	Signal
1	USB_VCC (+5V)	10	USB_VCC (+5V)
2	USB_DN0	11	USB_DN1
3	USB_DP0	12	USB_DP1
4	GND	13	GND
5	USB3_RXN0	14	USB3_RXN1
6	USB3_RXP0	15	USB3_RXP1
7	GND	16	GND
8	USB3_TXN0	17	USB3_TXN1
9	USB3_TXP0	18	USB3_TXP1

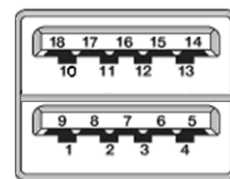

2.4.20 USB 2.0 Type A Port (USB3)

This connector is compliant with a Universal Serial Bus type-A connector for installing versatile USB 2.0 compliant interface peripherals.

Pin	Signal	Pin	Signal
1	USB VCC (+5V)	5	USB VCC (+5V)
2	DN2	6	DN3
3	DP2	7	DP3
4	GND	8	GND

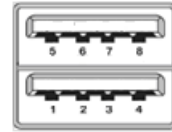

2.4.21 M.2 Key E Connector (SCN2)

The SCN2 is a M.2 2230 Key E connector. It is suggested to install the M.2 wireless module via PCIe x1 and USB 2.0 with 22mm width and 30mm length.

Pin	Signal	Pin	Signal
1	GND	2	+3.3V_SBY
3	USB_DP7	4	+3.3V_SBY
5	USB_DN7	6	NC
7	GND	8	NC
9	NC	10	NC
11	NC	12	NC
13	NC	14	NC
15	NC	16	NC
17	NC	18	GND
19	NC	20	NC
21	NC	22	NC
23	NC	24	Key E
25	Key E	26	
27		28	
29		30	
31		32	
33	GND	34	NC
35	PCIE_TX_P	36	NC
37	PCIE_TX_N	38	NC
39	GND	40	NC
41	PCIE_RX_P	42	NC
43	PCIE_RX_N	44	NC
45	GND	46	NC
47	PCIE_CLK_P	48	NC
49	PCIE_CLK_N	50	M_2_E_SUSCLK
51	GND	52	PERST#(+3.3V)
53	CLK_REQ2	54	W_DIS2#(+3.3V)
55	PEWAKE0#	56	W_DI12#(+3.3V)
57	GND	58	NC
59	NC	60	NC
61	NC	62	NC
63	GND	64	NC
65	NC	66	NC
67	NC	68	NC
69	GND	70	NC
71	NC	72	+3.3V_SBY
73	NC	74	+3.3V_SBY
75	GND		

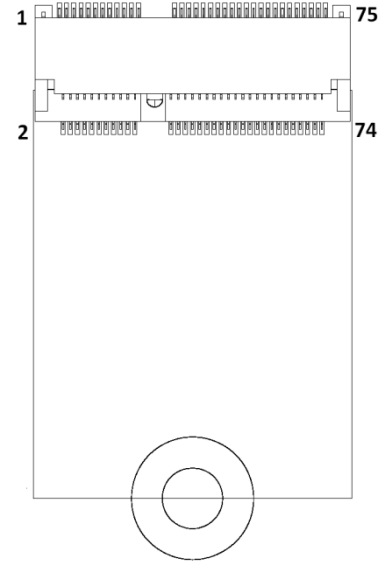

2.4.22 Full-size PCI-Express Mini Card Connector (SCN3)

This is a full-size PCI-Express Mini Card connector complying with PCI-Express Mini Card Spec. V1.2. Located on the bottom side of the board and supports either PCI-Express, USB or mSATA. Note that the factory default is mSATA, you can change to PCI Express by BIOS select (see BIOS Setup Utility: Advanced\Storage Configuration\PCIE Mini Card Function in section 4.4).

Pin	Signal	Pin	Signal
1	WAKE#	2	+3.3VSB
3	No use	4	GND
5	No use	6	+1.5V
7	CLKREQ#	8	SIM_PWR
9	GND	10	SIM_I/O
11	REFCLK-	12	SIM_CLK
13	REFCLK+	14	SIM_RST
15	GND	16	SIM_VPP
17	No use	18	GND
19	No use	20	No use
21	GND	22	PERST#
23	PCIE_RX1_N/SATA_RX0_P	24	+3.3VSB
25	PCIE_RX1_P/SATA_RX0_N	26	GND
27	GND	28	+1.5V
29	GND	30	SMB_CLK
31	PCIE_TX1_N/SATA_TX0_N	32	SMB_DATA
33	PCIE_TX1_P/SATA_TX0_P	34	GND
35	GND	36	USB_DN8
37	GND	38	USB_DP8
39	+3.3VSB	40	GND
41	+3.3VSB	42	No use
43	GND	44	No use
45	No use	46	No use
47	No use	48	+1.5V
49	No use	50	GND
51	No use	52	+3.3VSB

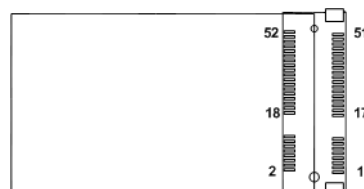

2.4.23 M.2 Key B Connector (SCN4)

The SCN2 is a M.2 Key B connector. It is suggested to install the M.2 cellular module with 30mm width and 42mm length or 30mm width and 50/52mm length.



Note: If NVMe storage card with 22mm width and 42mm length is needed to install, the BIOS needs to be changed.

Note

Pin	Signal	Pin	Signal
1	CONFIG_3	2	+3.3V_SBY
3	GND	4	+3.3V_SBY
5	GND	6	+1.8V_SBY
7	USB_DP9	8	N/C
9	USB_DN9	10	NC
11	GND	12	Key B
13	Key B	14	
15		16	
17		18	
19		20	NC
21	CONFIG_0	22	NC
23	GPIO11(+1.8V)	24	NC
25	NC	26	NC
27	GND	28	NC
29	PCIE_1_RXN / USB3_3_RXN	30	SIM_RESET
31	PCIE_1_RXP / USB3_3_RXP	32	SIM_CLK
33	GND	34	SIM_DATA
35	PCIE_1_TXN / USB3_3_TXN	36	SIM_PWR
37	PCIE_1_TXP / USB3_3_TXP	38	DEVSHP1
39	GND	40	NC
41	PCIE_0_RXN	42	NC
43	PCIE_0_RXP	44	NC
45	GND	46	NC
47	PCIE_0_TXN	48	NC
49	PCIE_0_TXP	50	PERST#
51	GND	52	CLK_REQ4
53	PCIE_CLK_N	54	PEWAKE#
55	PCIE_CLK_P	56	NC
57	GND	58	NC
59	NC	60	NC
61	NC	62	NC
63	NC	64	NC
65	NC	66	NC
67	PLTRST(+1.8V)	68	SUSCLK
69	CONFIG_1	70	+3.3V_SBY
71	GND	72	+3.3V_SBY
73	GND	74	+3.3V_SBY
75	CONFIG_2		

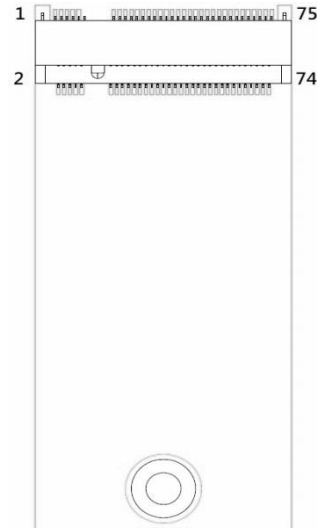

This page is intentionally left blank.

Section 3

Hardware Description

3.1 Microprocessors

The CAPA322 supports Intel® Celeron® processor J6412 and N6210 & Atom® x6413E processor which enable your system to operate under Windows® 10 environments. The system performance depends on the microprocessor. Make sure all correct settings are arranged for the installed microprocessor to prevent the CPU from damages.



















































3.2 BIOS























The CAPA322 uses AMI Plug and Play BIOS with a single 256Mbit SPI Flash.

3.3 System Memory

The CAPA322 supports one 260-pin DDR4 SO-DIMM sockets. The memory module comes in sizes of 4GB, 8GB, 16GB and 32GB.











































3.4 I/O Port Address Map

▼		Input/output (IO)	
		[0000000000000000 - 000000000000CF7]	PCI Express Root Complex
		[0000000000000020 - 0000000000000021]	Programmable interrupt controller
		[0000000000000024 - 0000000000000025]	Programmable interrupt controller
		[0000000000000028 - 0000000000000029]	Programmable interrupt controller
		[000000000000002C - 000000000000002D]	Programmable interrupt controller
		[000000000000002E - 000000000000002F]	Motherboard resources
		[0000000000000030 - 0000000000000031]	Programmable interrupt controller
		[0000000000000034 - 0000000000000035]	Programmable interrupt controller
		[0000000000000038 - 0000000000000039]	Programmable interrupt controller
		[000000000000003C - 000000000000003D]	Programmable interrupt controller
		[0000000000000040 - 0000000000000043]	System timer
		[000000000000004E - 000000000000004F]	Motherboard resources
		[0000000000000050 - 0000000000000053]	System timer
		[0000000000000061 - 0000000000000061]	Motherboard resources
		[0000000000000062 - 0000000000000062]	Microsoft ACPI-Compliant Embedded Controller
		[0000000000000063 - 0000000000000063]	Motherboard resources
		[0000000000000065 - 0000000000000065]	Motherboard resources
		[0000000000000066 - 0000000000000066]	Microsoft ACPI-Compliant Embedded Controller
		[0000000000000067 - 0000000000000067]	Motherboard resources
		[0000000000000070 - 0000000000000070]	Motherboard resources
		[0000000000000080 - 0000000000000080]	Motherboard resources
		[0000000000000092 - 0000000000000092]	Motherboard resources
		[00000000000000A0 - 00000000000000A1]	Programmable interrupt controller
		[00000000000000A4 - 00000000000000A5]	Programmable interrupt controller
		[00000000000000A8 - 00000000000000A9]	Programmable interrupt controller
		[00000000000000AC - 00000000000000AD]	Programmable interrupt controller
		[00000000000000B0 - 00000000000000B1]	Programmable interrupt controller
		[00000000000000B2 - 00000000000000B3]	Motherboard resources
		[00000000000000B4 - 00000000000000B5]	Programmable interrupt controller
		[00000000000000B8 - 00000000000000B9]	Programmable interrupt controller
		[00000000000000BC - 00000000000000BD]	Programmable interrupt controller
		[00000000000002E8 - 00000000000002EF]	Communications Port (COM4)
		[00000000000002F8 - 00000000000002FF]	Communications Port (COM2)
		[00000000000003E8 - 00000000000003EF]	Communications Port (COM1)
		[00000000000003F8 - 00000000000003FF]	Communications Port (COM1)
		[00000000000004D0 - 00000000000004D1]	Programmable interrupt controller
		[0000000000000680 - 000000000000069F]	Motherboard resources
		[0000000000000A00 - 0000000000000A0F]	Motherboard resources
		[0000000000000D00 - 0000000000000FFF]	PCI Express Root Complex
		[000000000000164E - 000000000000164F]	Motherboard resources
		[0000000000001800 - 00000000000018FE]	Motherboard resources
		[0000000000001854 - 0000000000001857]	Motherboard resources
		[0000000000002000 - 00000000000020FE]	Motherboard resources
		[0000000000003000 - 0000000000003FFF]	Intel(R) PCI Express Root Port #6 - 4B3E
		[0000000000004000 - 0000000000004FFF]	Intel(R) PCI Express Root Port #1 - 4B39
		[0000000000005000 - 000000000000503F]	Intel(R) UHD Graphics
		[0000000000005060 - 000000000000507F]	Standard SATA AHCI Controller
		[0000000000005080 - 0000000000005083]	Standard SATA AHCI Controller
		[0000000000005090 - 0000000000005097]	Standard SATA AHCI Controller
		[000000000000EFA0 - 000000000000EFBF]	Intel(R) SMBus Controller - 4B23

	(ISA) 0x000001FC (508)	Microsoft ACPI-Compliant System
	(ISA) 0x000001FD (509)	Microsoft ACPI-Compliant System
	(ISA) 0x000001FE (510)	Microsoft ACPI-Compliant System
	(ISA) 0x000001FF (511)	Microsoft ACPI-Compliant System
	(PCI) 0x00000010 (16)	High Definition Audio Controller
	(PCI) 0xFFFFFFFF (-19)	Intel(R) Management Engine Interface #1
	(PCI) 0xFFFFFFFFE (-18)	Intel(R) Ethernet Controller (3) I225-LM
	(PCI) 0xFFFFFFFFF (-17)	Intel(R) Ethernet Controller (3) I225-LM
	(PCI) 0xFFFFFFFF0 (-16)	Intel(R) Ethernet Controller (3) I225-LM
	(PCI) 0xFFFFFFFF1 (-15)	Intel(R) Ethernet Controller (3) I225-LM
	(PCI) 0xFFFFFFFF2 (-14)	Intel(R) Ethernet Controller (3) I225-LM
	(PCI) 0xFFFFFFFF3 (-13)	Intel(R) USB 3.10 eXtensible Host Controller - 1.20 (Microsoft)
	(PCI) 0xFFFFFFFF4 (-12)	Intel(R) UHD Graphics
	(PCI) 0xFFFFFFFF5 (-11)	Intel(R) I210 Gigabit Network Connection
	(PCI) 0xFFFFFFFF6 (-10)	Intel(R) I210 Gigabit Network Connection
	(PCI) 0xFFFFFFFF7 (-9)	Intel(R) I210 Gigabit Network Connection
	(PCI) 0xFFFFFFFF8 (-8)	Intel(R) I210 Gigabit Network Connection
	(PCI) 0xFFFFFFFF9 (-7)	Intel(R) I210 Gigabit Network Connection
	(PCI) 0xFFFFFFFFFA (-6)	Intel(R) I210 Gigabit Network Connection
	(PCI) 0xFFFFFFFFFB (-5)	Standard SATA AHCI Controller
	(PCI) 0xFFFFFFFFFC (-4)	Intel(R) PCI Express Root Port #6 - 4B3E
	(PCI) 0xFFFFFFFFFD (-3)	Intel(R) PCI Express Root Port #4 - 4B3C
	(PCI) 0xFFFFFFFFFE (-2)	Intel(R) PCI Express Root Port #1 - 4B39

3.6 Memory Map

The memory mapping list is shown as follows:

▼	 Memory	
		[0000000000A0000 - 0000000000BFFFF] PCI Express Root Complex
		[0000000000E0000 - 0000000000E3FFF] PCI Express Root Complex
		[0000000000E4000 - 0000000000E7FFF] PCI Express Root Complex
		[0000000000E8000 - 0000000000EBFFF] PCI Express Root Complex
		[0000000000EC000 - 0000000000EFFFF] PCI Express Root Complex
		[0000000000F0000 - 0000000000FFFFFF] PCI Express Root Complex
		[00000007FC00000 - 0000000805FFFFFF] Intel(R) PCI Express Root Port #1 - 4B39
		[00000007FC00000 - 0000000BFFFFFF] PCI Express Root Complex
		[000000080600000 - 0000000808FFFFFF] Intel(R) PCI Express Root Port #4 - 4B3C
		[000000080700000 - 0000000807FFFFFF] Intel(R) Ethernet Controller (3) I225-LM
		[000000080800000 - 000000080803FFF] Intel(R) Ethernet Controller (3) I225-LM
		[000000080900000 - 00000008097FFFF] Intel(R) I210 Gigabit Network Connection
		[000000080900000 - 0000000809FFFFFF] Intel(R) PCI Express Root Port #6 - 4B3E
		[000000080980000 - 000000080983FFF] Intel(R) I210 Gigabit Network Connection
		[000000080A00000 - 000000080A01FFF] Standard SATA AHCI Controller
		[000000080A02000 - 000000080A027FF] Standard SATA AHCI Controller
		[000000080A03000 - 000000080A030FF] Standard SATA AHCI Controller
		[0000000C0000000 - 0000000CFFFFFF] Motherboard resources
		[0000000FD000000 - 0000000FD68FFFF] Motherboard resources
		[0000000FD6B0000 - 0000000FD6CFFFF] Motherboard resources
		[0000000FD6F0000 - 0000000FDFFFFFF] Motherboard resources
		[0000000FE000000 - 0000000FE01FFFF] Motherboard resources
		[0000000FE010000 - 0000000FE010FFF] Intel(R) SPI (flash) Controller - 4B24
		[0000000FE200000 - 0000000FE7FFFFF] Motherboard resources
		[0000000FEC80000 - 0000000FECFFFFFF] Motherboard resources
		[0000000FED00000 - 0000000FED003FF] High precision event timer
		[0000000FED20000 - 0000000FED7FFFF] Motherboard resources
		[0000000FED40000 - 0000000FED44FFF] Trusted Platform Module 2.0
		[0000000FED45000 - 0000000FED8FFFF] Motherboard resources
		[0000000FED90000 - 0000000FED93FFF] Motherboard resources
		[0000000FEDA0000 - 0000000FEDA0FFF] Motherboard resources
		[0000000FEDA1000 - 0000000FEDA1FFF] Motherboard resources
		[0000000FEE00000 - 0000000FEEFFFFFF] Motherboard resources
		[0000000FF000000 - 0000000FFFFFFF] Motherboard resources
		[0000004000000000 - 000000400FFFFFFF] Intel(R) UHD Graphics
		[0000006000000000 - 00000060009FFFFFF] Intel(R) PCI Express Root Port #1 - 4B39
		[0000006001000000 - 0000006001FFFFFF] Intel(R) UHD Graphics
		[0000006002100000 - 000000600210FFFF] Intel(R) USB 3.10 eXtensible Host Controller - 1.20 (Microsoft)
		[0000006002118000 - 00000060021180FF] Intel(R) SMBus Controller - 4B23
		[00000077FFEFB000 - 00000077FFEFBFFF] Intel(R) Management Engine Interface #1
		[00000077FFEF0000 - 00000077FFEFFFFF] High Definition Audio Controller
		[00000077FFF00000 - 00000077FFF0FFFF] High Definition Audio Controller

Section 4

AMI BIOS Setup Utility

The AMI UEFI BIOS provides users with a built-in setup program to modify basic system configuration. All configured parameters are stored in a flash chip to save the setup information whenever the power is turned off. This section provides users with detailed description about how to set up basic system configuration through the AMI BIOS setup utility.

4.1 Starting

To enter the setup screens, follow the steps below:

1. Turn on the computer and press the key immediately.
2. After you press the key, the main BIOS setup menu displays. You can access the other setup screens from the main BIOS setup menu, such as the Advanced and Chipset menus.



Note

If your computer cannot boot after making and saving system changes with BIOS setup, you can restore BIOS optimal defaults by setting SW1 (see section 2.3.2).

It is strongly recommended that you should avoid changing the chipset's defaults. Both AMI and your system manufacturer have carefully set up these defaults that provide the best performance and reliability.

4.2 Navigation Keys

The BIOS setup/utility uses a key-based navigation system called hot keys. Most of the BIOS setup utility hot keys can be used at any time during the setup navigation process. These keys include <F1>, <F2>, <Enter>, <ESC>, <Arrow> keys, and so on.



Note

Some of the navigation keys differ from one screen to another.

Hot Keys	Description
→← Left/Right	The Left and Right <Arrow> keys allow you to select a setup screen.
↑↓ Up/Down	The Up and Down <Arrow> keys allow you to select a setup screen or sub-screen.
Enter	The <Enter> key allows you to display or change the setup option listed for a particular setup item. The <Enter> key can also allow you to display the setup sub- screens.
+– Plus/Minus	The Plus and Minus <Arrow> keys allow you to change the field value of a particular setup item.
Tab	The <Tab> key allows you to select setup fields.
F1	The <F1> key allows you to display the General Help screen.
F2	The <F2> key allows you to Load Previous Values.
F3	The <F3> key allows you to Load Optimized Defaults.
F4	The <F4> key allows you to save any changes you have made and exit Setup. Press the <F4> key to save your changes.
Esc	The <Esc> key allows you to discard any changes you have made and exit the Setup. Press the <Esc> key to exit the setup without saving your changes.

4.3 Main Menu

When you first enter the setup utility, you will enter the Main setup screen. You can always return to the Main setup screen by selecting the Main tab. System Time/Date can be set up as described below. The Main BIOS setup screen is shown below.

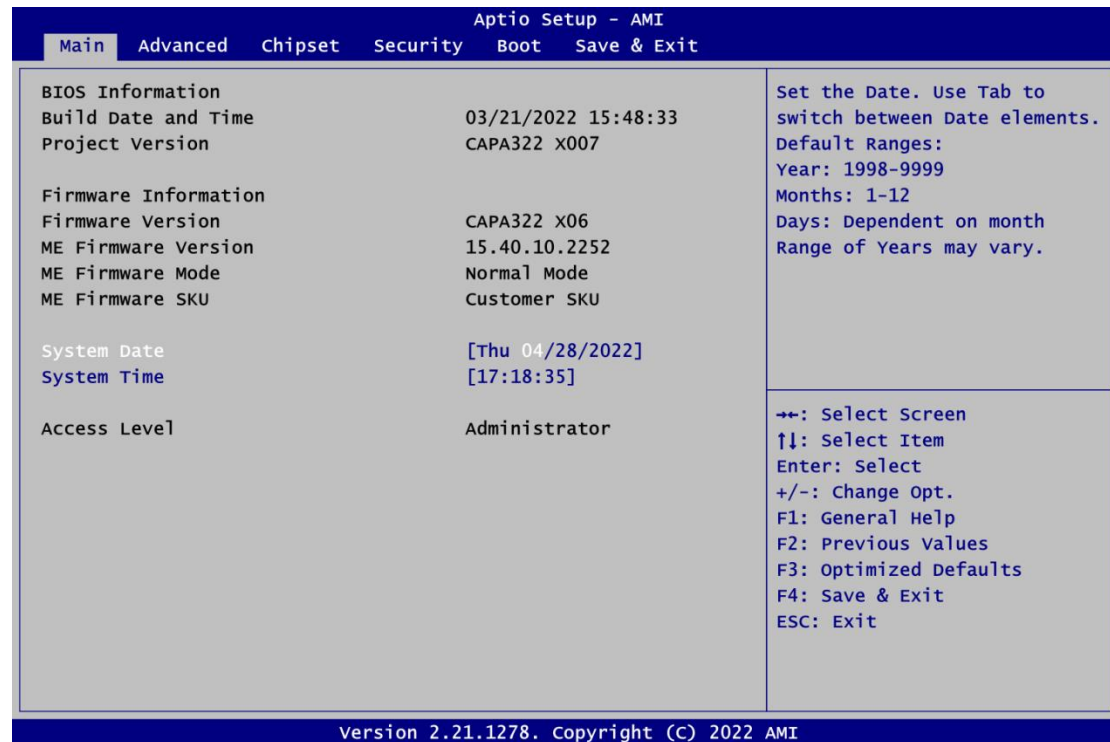

- BIOS and Firmware Information**
 Display BIOS and firmware information.
- System Date/Time**
 Use this option to change the system time and date. Highlight System Time or System Date using the <Arrow> keys. Enter new values through the keyboard. Press the <Tab> key or the <Arrow> keys to move between fields. The date must be entered in MM/DD/YY format. The time is entered in HH:MM:SS format.
- Access Level**
 Display the access level of current user.

4.4 Advanced Menu

The Advanced menu also allows users to set configuration of the CPU and other system devices. You can select any of the items in the left frame of the screen to go to the sub menus:

- ▶ F81216 Super IO Configuration
- ▶ Ec DIO Configuration
- ▶ Hardware Monitor
- ▶ Trusted Computing
- ▶ CPU Configuration
- ▶ Storage Configuration
- ▶ USB Configuration

For items marked with “▶”, please press <Enter> for more options.

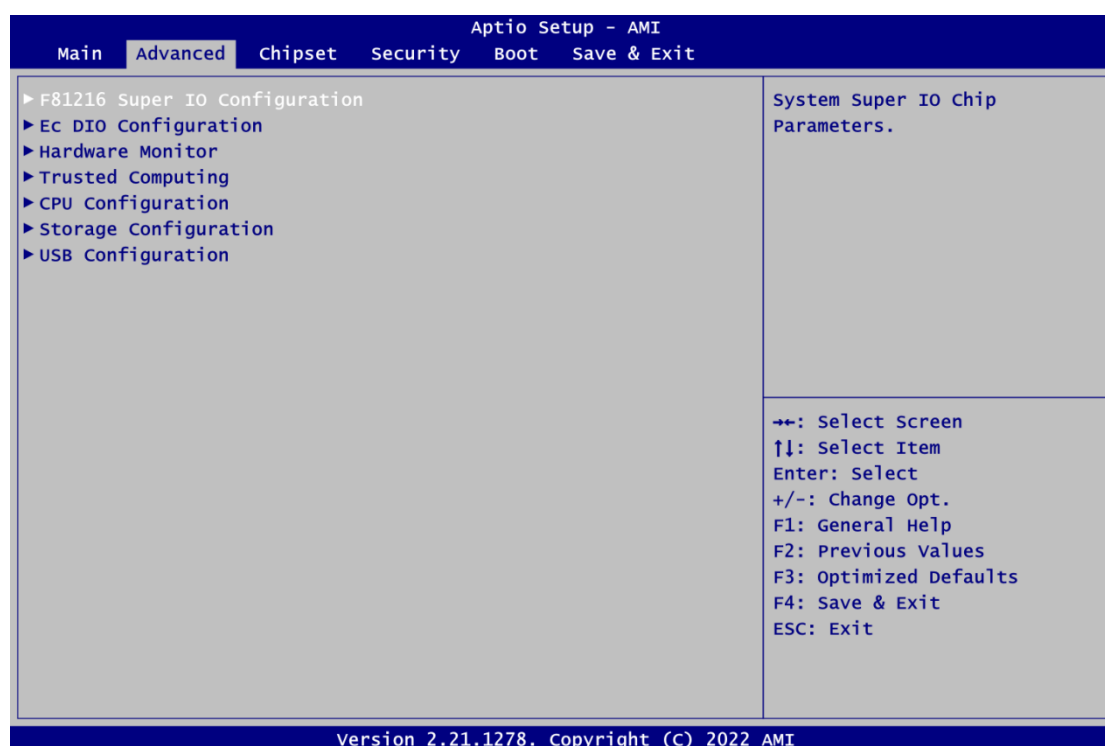

- **F81216 Super IO Configuration**

You can use this screen to select options for Super IO Configuration, and change the value of the selected option. A description of the selected item appears on the right side of the screen. For items marked with "▶", please press <Enter> for more options.

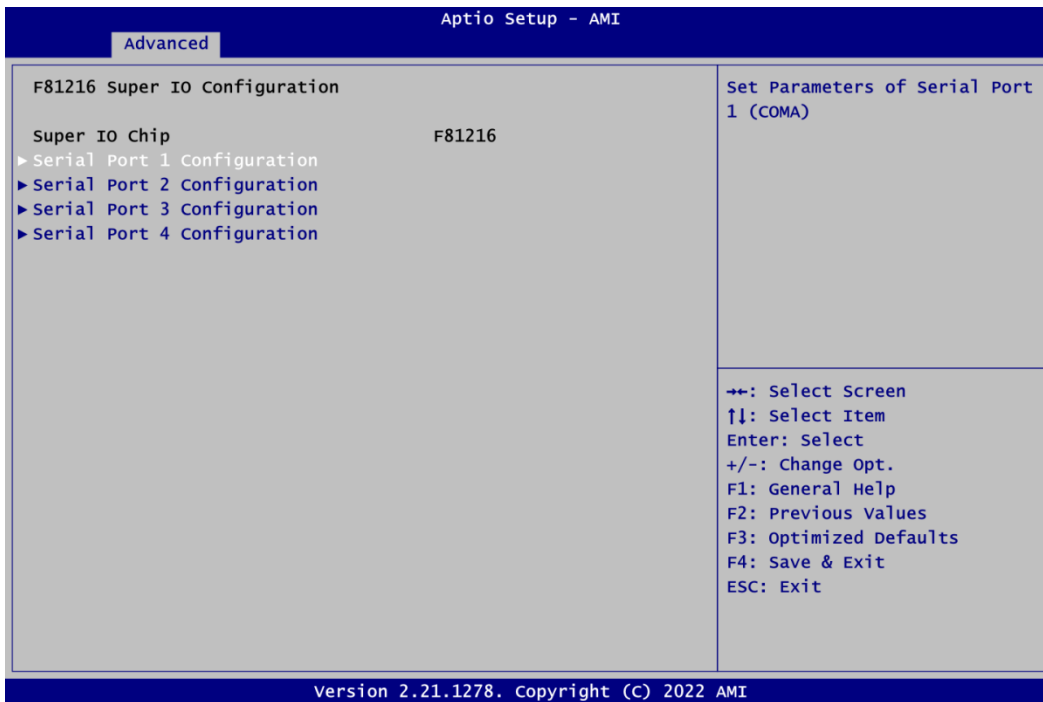

Serial Port 1~4 Configuration

Use these items to set parameters related to serial port 1~4.

● **Serial Port 1~2 Configuration**

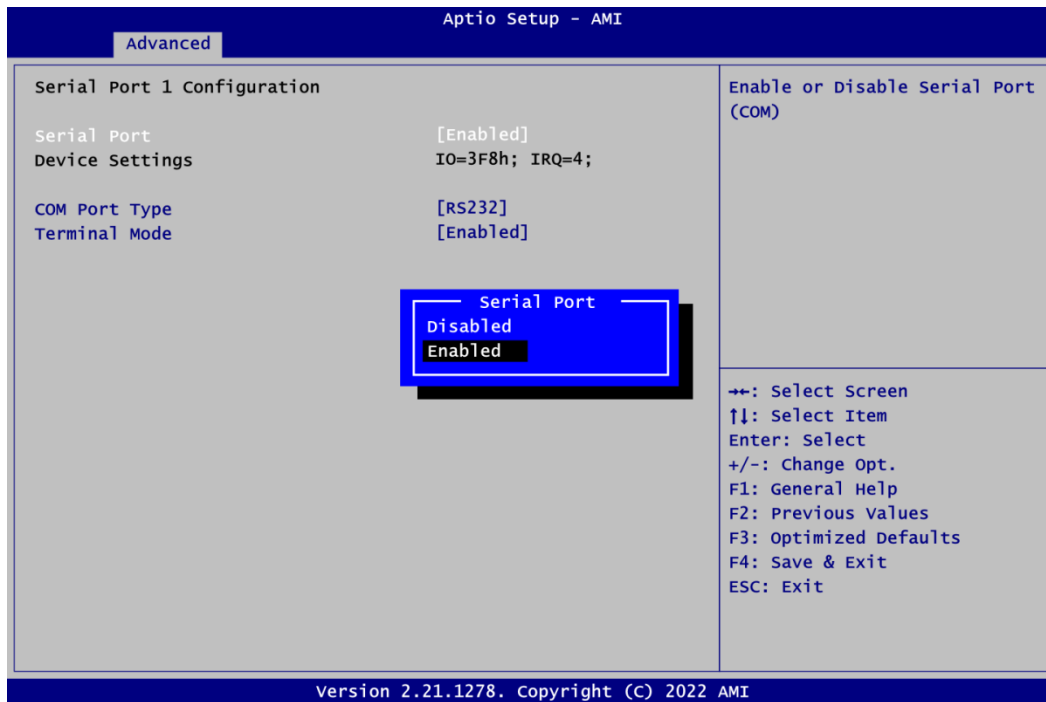

Serial Port 1~2

Enable or disable serial port 1~2. The optimal settings for base I/O address and for interrupt request address are:

- Serial port 1: 3F8h, IRQ4
- Serial port 2: 3E8h, IRQ3

COM Port Type

Use this item to set RS-232/422/485 communication mode.

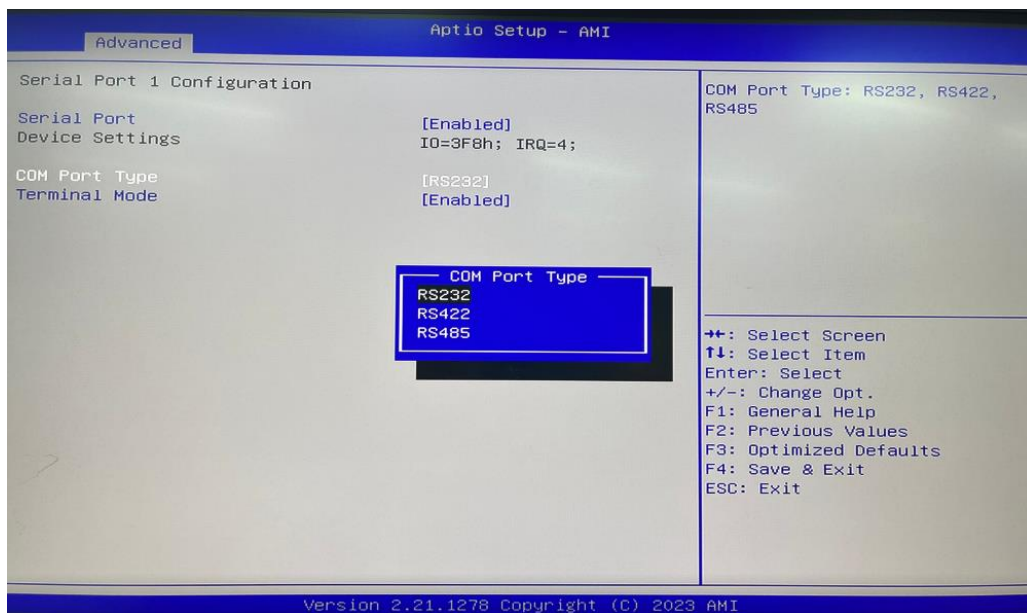

Terminal Mode

Enable terminal mode to enable the RS-422/485 termination resistor to enhance the signal.

- **Serial Port 3~4 Configuration**

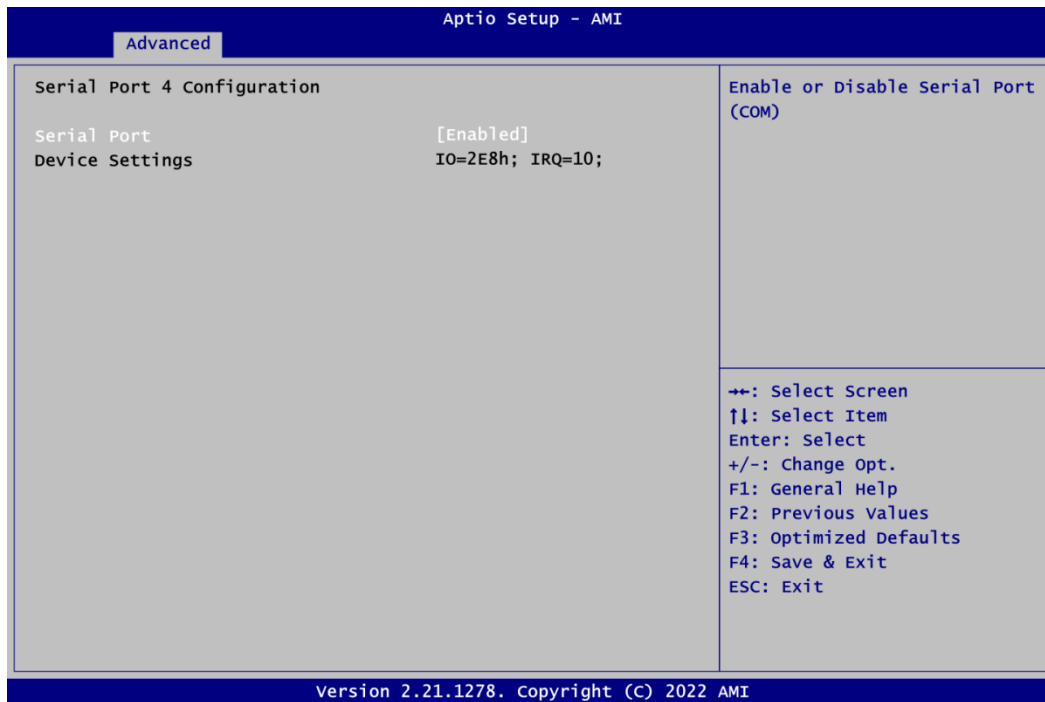
**Serial Port 3~4**

Enable or disable serial port 3~4. The optimal settings for base I/O address and for interrupt request address are:

- Serial port 3: 2F8h, IRQ11
- Serial port 4: 2E8h, IRQ10

- **Ec DIO Configuration**

You can use this screen to select options for the 8-bit Digital I/O Configuration. A description of the selected item appears on the right side of the screen. For items marked with "►", please press <Enter> for more options.

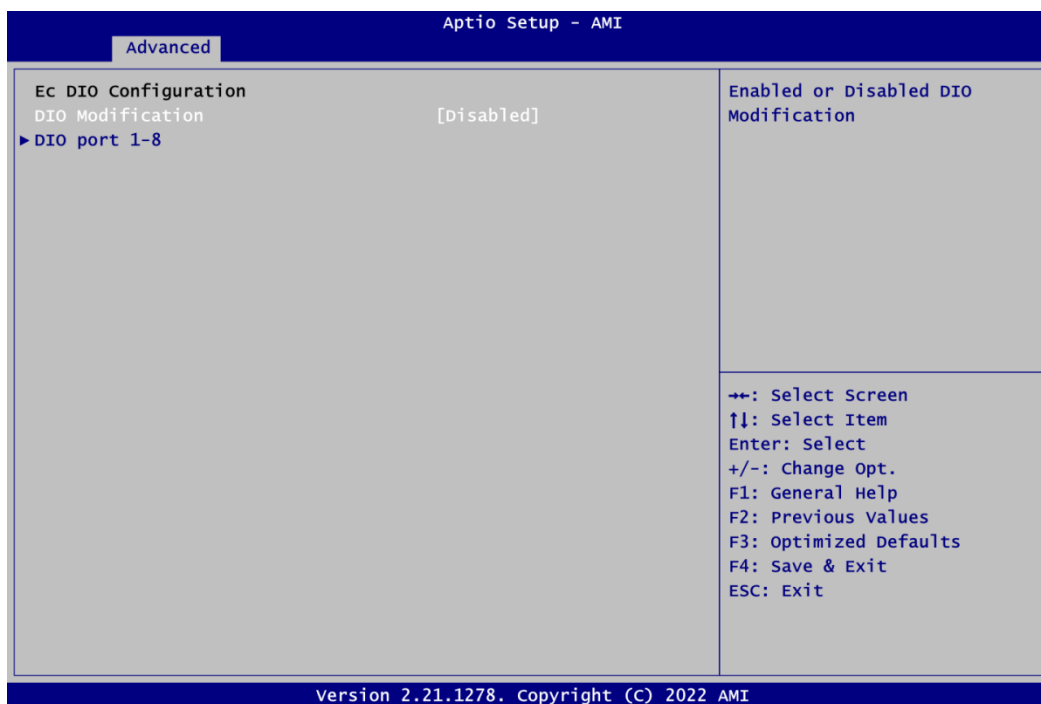

DIO Modification

Enable or disable digital I/O modification. If modification is disabled, the DIO status sub screen is as follows:

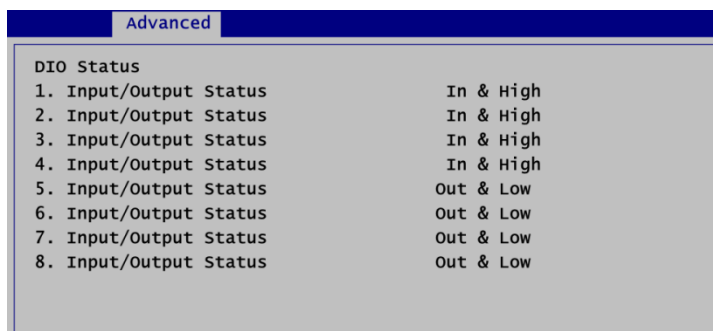

Once it is enabled, you can load manufacture default and access to the DIO status sub screen to set output or input, see image below.

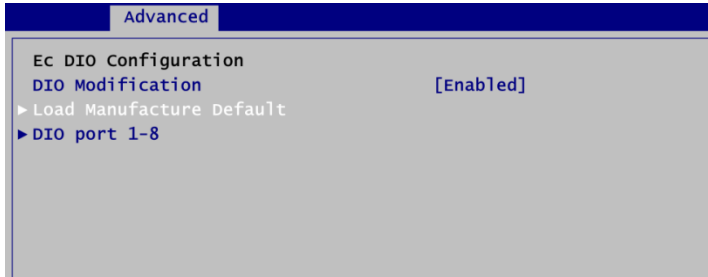

DIO port 1-8

Select this option to open DIO status sub-screen.

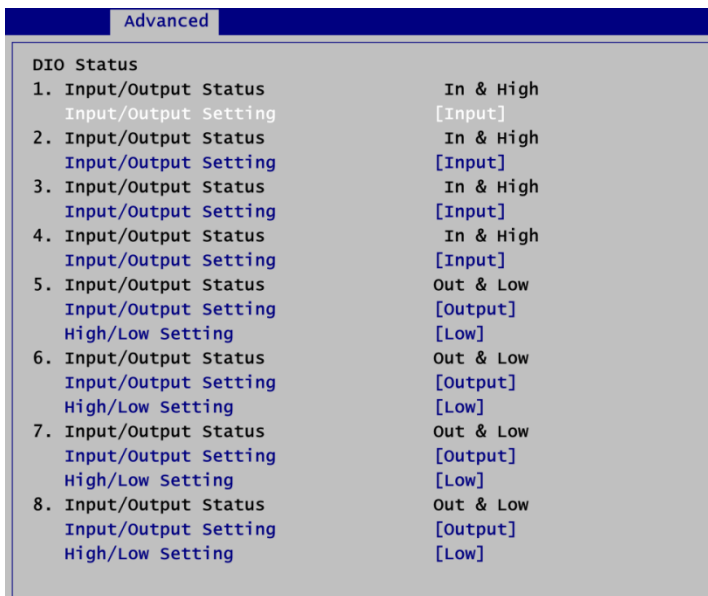

- **Hardware Monitor**

This screen displays hardware health status.

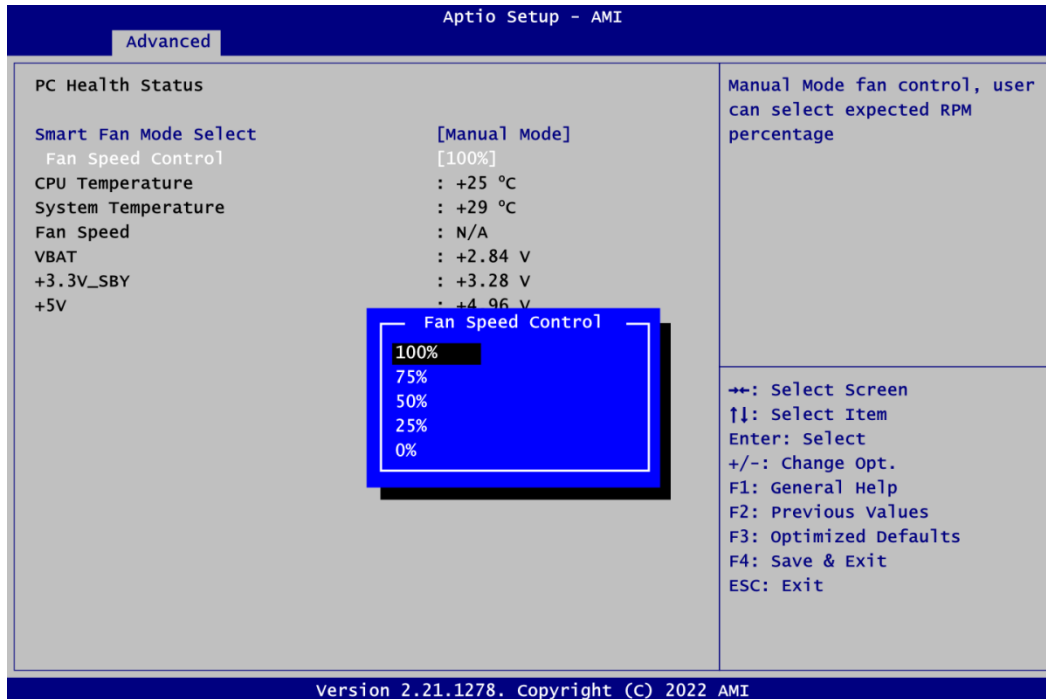

This screen displays the temperature of system and CPU, fan speed in RPM and system voltages (VBAT, +3.3V_SBY and +5V).

Smart Fan Mode Select

If a fan is installed in CN2, Smart Fan mode can be set. The default is Auto Mode. In Auto Mode, the fan spins at different speed depending on system temperature; the higher the temperature is, the faster the system fan spins. In Manual Mode; select fan speed control item, then user can manually change system fan speed to 100%, 75%, 50% or 0% (see image below).



Note

The fan speed to 100%, 75%, 50% or 0% is to adjust the PWM voltage of CPU FAN. It does not directly adjust the FAN speed.

- **Trusted Computing**

This screen provides function for specifying the TPM settings.

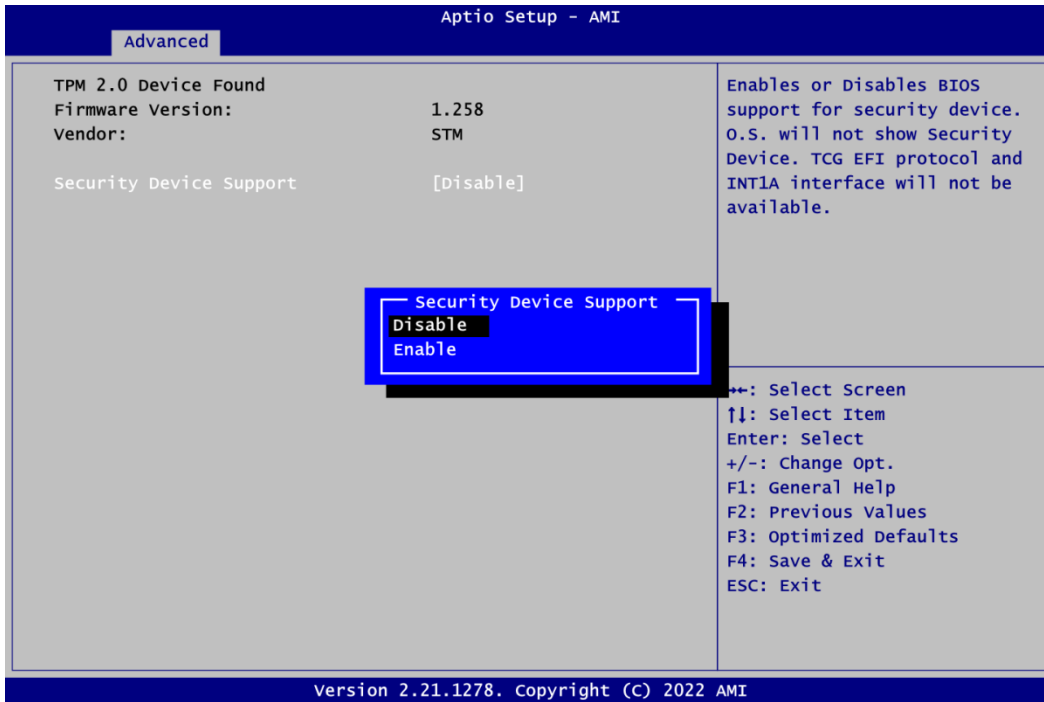

Security Device Support

Enable or disable BIOS support for security device. Once the Security Device Support is enabled, you will see the following screen.

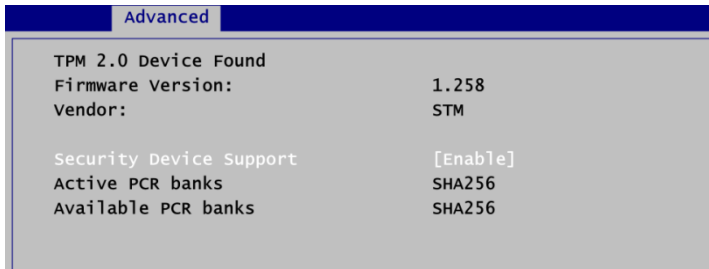

- **CPU Configuration**

This screen shows the CPU Configuration.

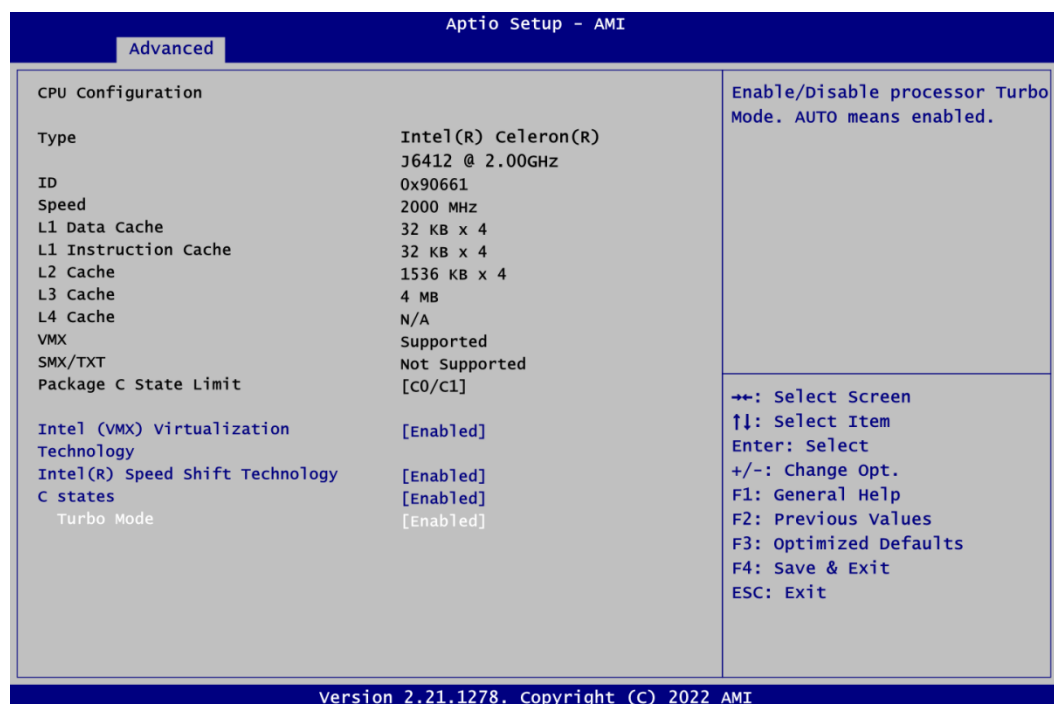

Intel Virtualization Technology

Enable or disable Intel Virtualization Technology. When enabled, a VMM (Virtual Machine Mode) can utilize the additional hardware capabilities. It allows a platform to run multiple operating systems and applications independently, hence enabling a computer system to work as several virtual systems.

Intel(R) Speed Shift Technology

Enable or disable Intel Speed Shift Technology support. Enabling will expose the CPPC v2 interface to allow for hardware controlled P-states.

Turbo Mode

Enable or disable processor Turbo Mode.

- **Storage Configuration**

During system boot up, the BIOS automatically detects the presence of SATA devices. In the SATA Configuration menu, you can see all hardware currently installed in SATA ports.

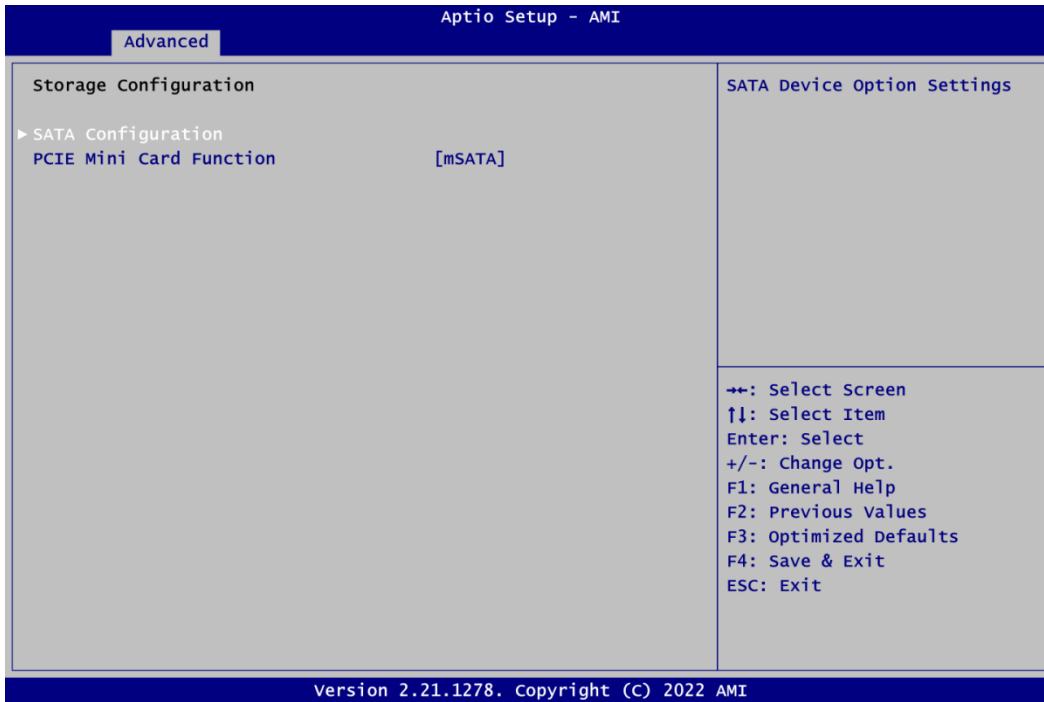
**SATA Configuration**

Select to open SATA device setting sub-screen.

PCIe Mini Card Function

Set PCI-Express Mini Card (SCN3) to work as PCI-Express or mSATA. The default is mSATA.

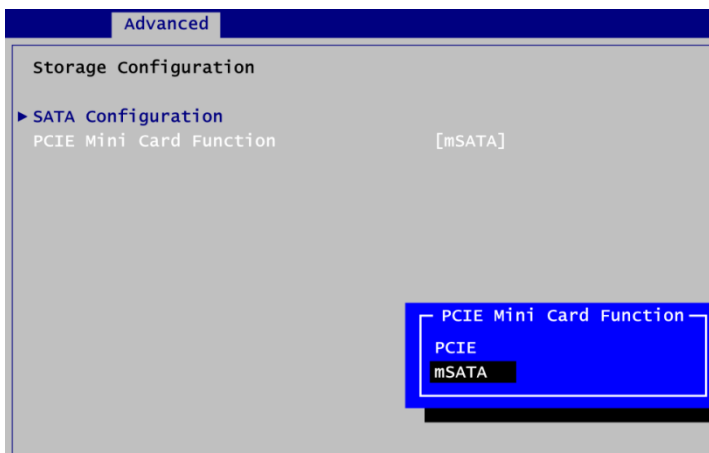

SATA Configuration

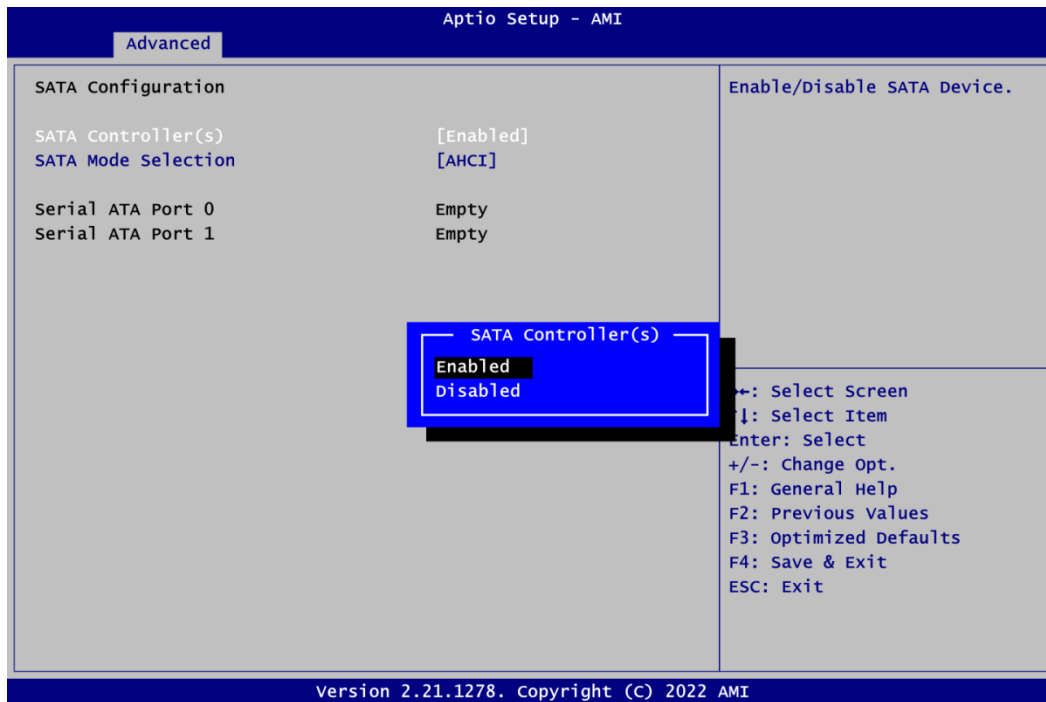

SATA Controller(s)

Enable or disable SATA device.

SATA Mode Selection

Determine how SATA controller(s) operate.

- AHCI (Advanced Host Controller Interface)

- **USB Configuration**

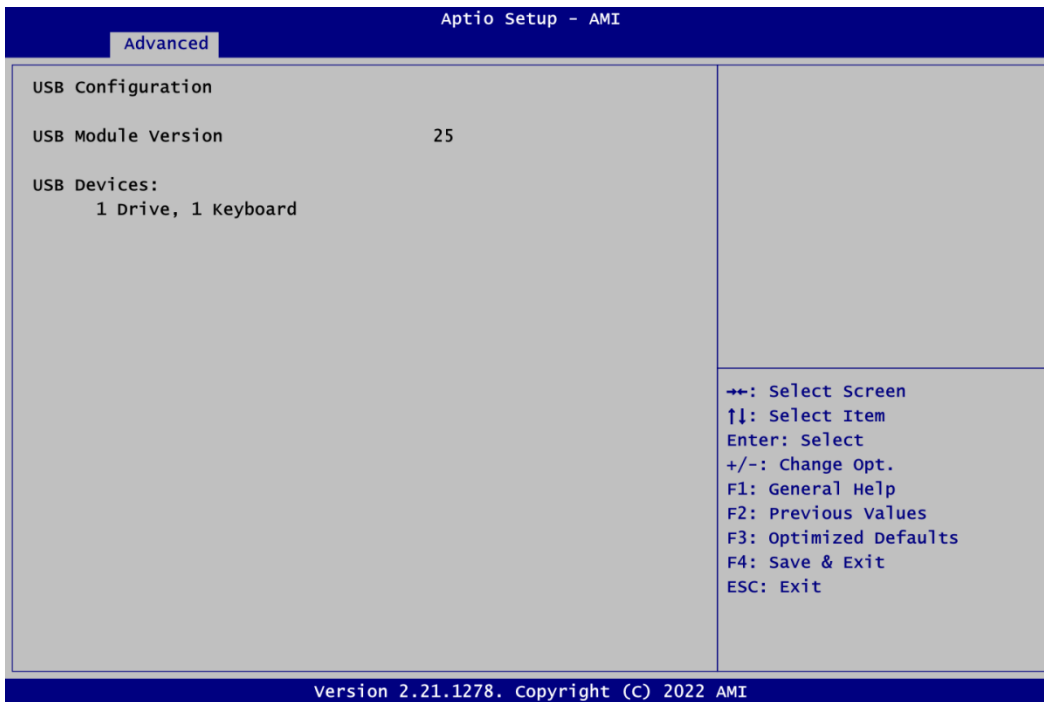
**USB Devices**

Display all detected USB devices.

4.5 Chipset Menu

The Chipset menu allows users to change the advanced chipset settings.

- **System Agent (SA) Configuration**

This screen allows users to configure System Agent (SA) parameters.

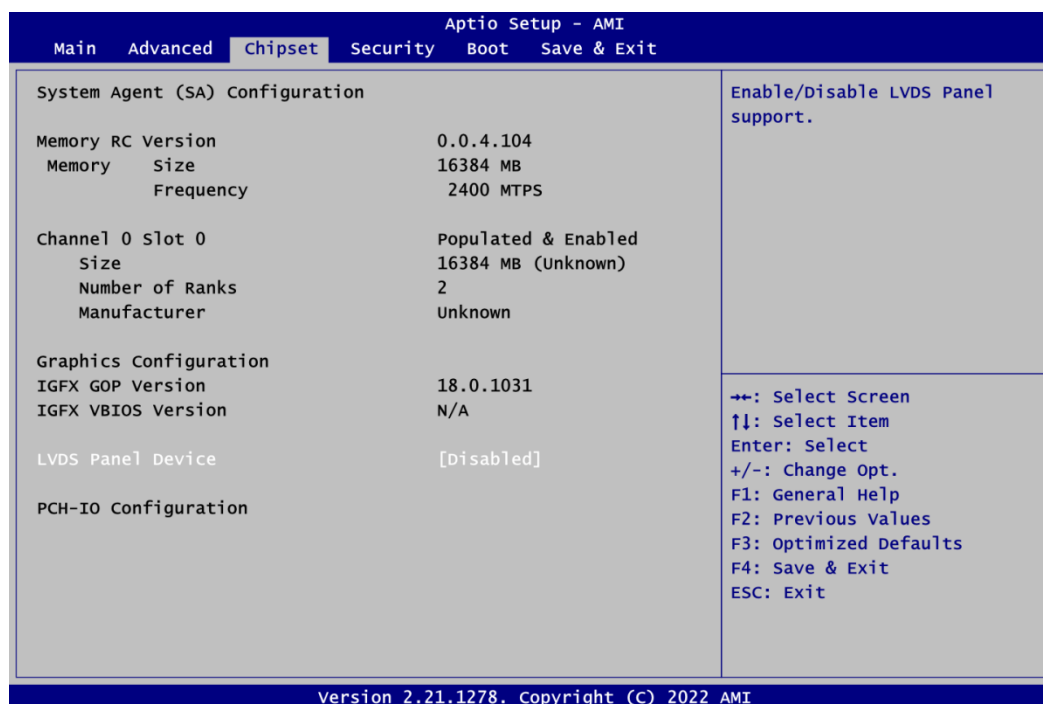

LVDS Panel Device

Enable or disable LVDS panel support. If enabled, you will see:

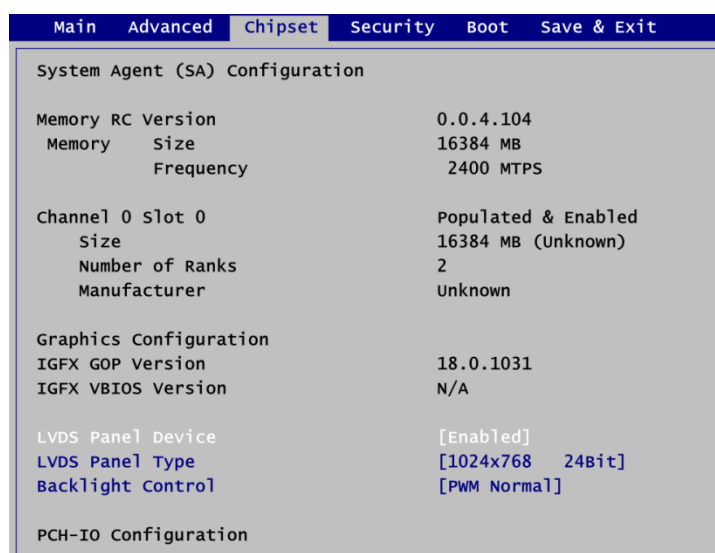

LVDS Panel Type

Select the appropriate LVDS panel resolution, see image below.

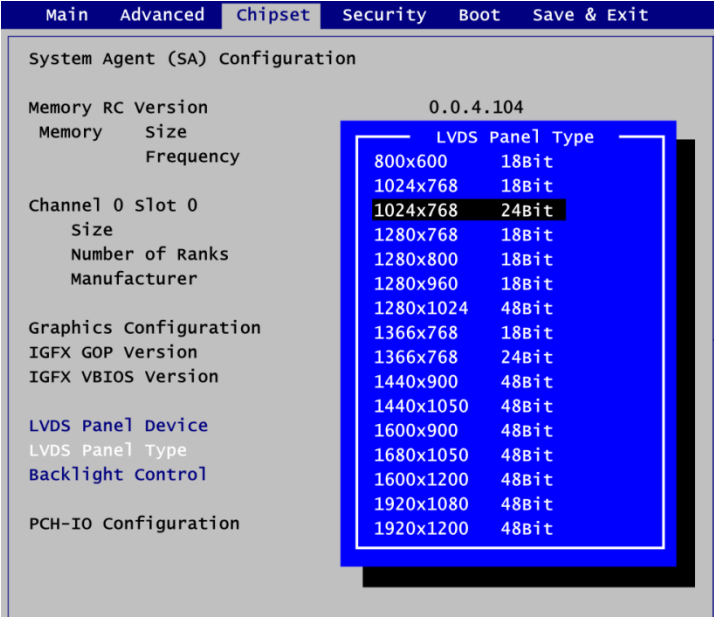

Backlight Control

Backlight control options:

- PWM Inverted (backlight 100 to 0)
- PWM Normal (backlight 0 to 100)

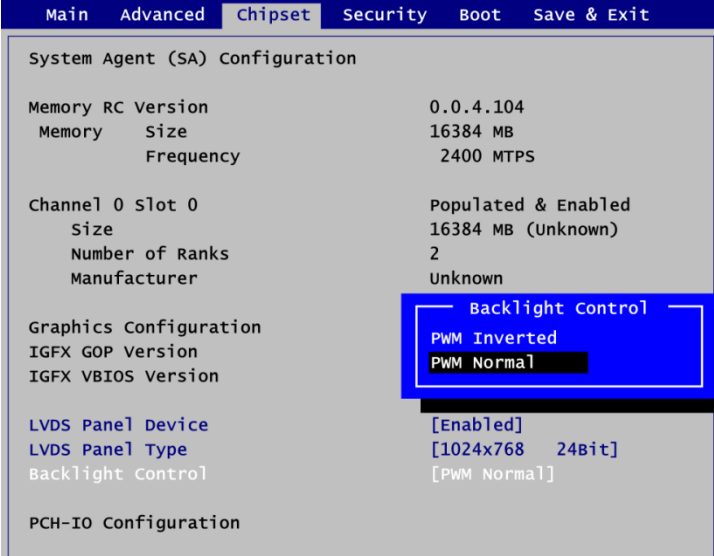

4.6 Security Menu

The Security menu allows users to change the security settings for the system.

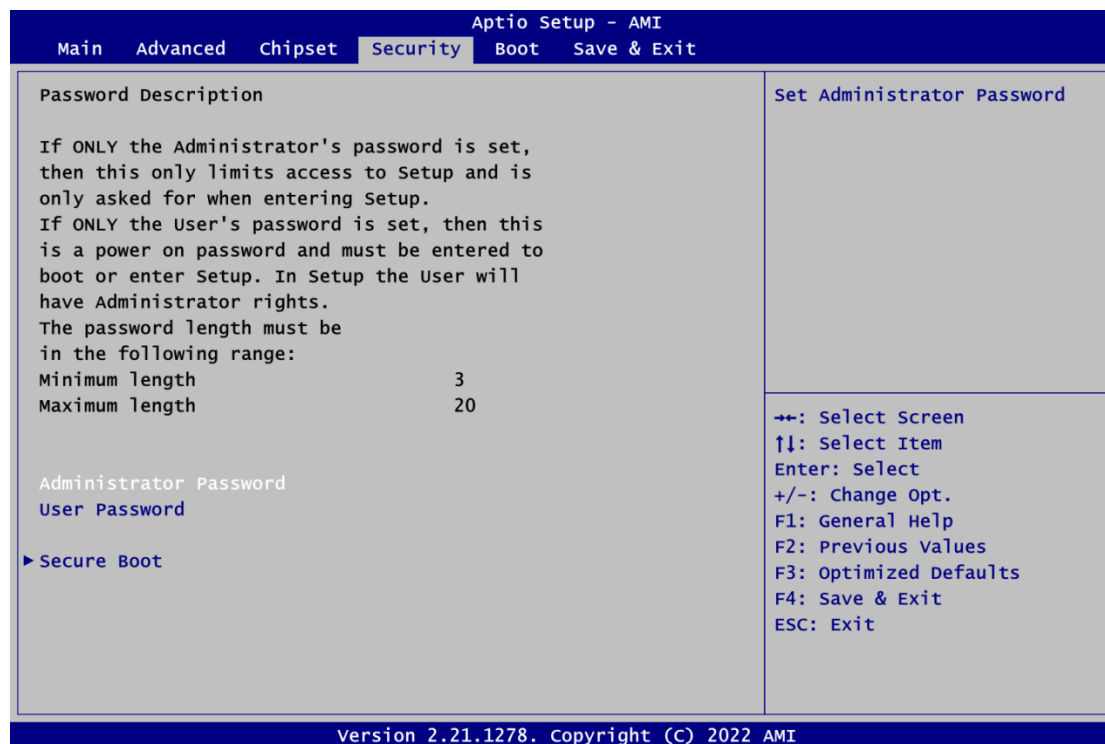

- **Administrator Password.**
Set administrator password.
- **User Password**
Set user password.

Secure Boot

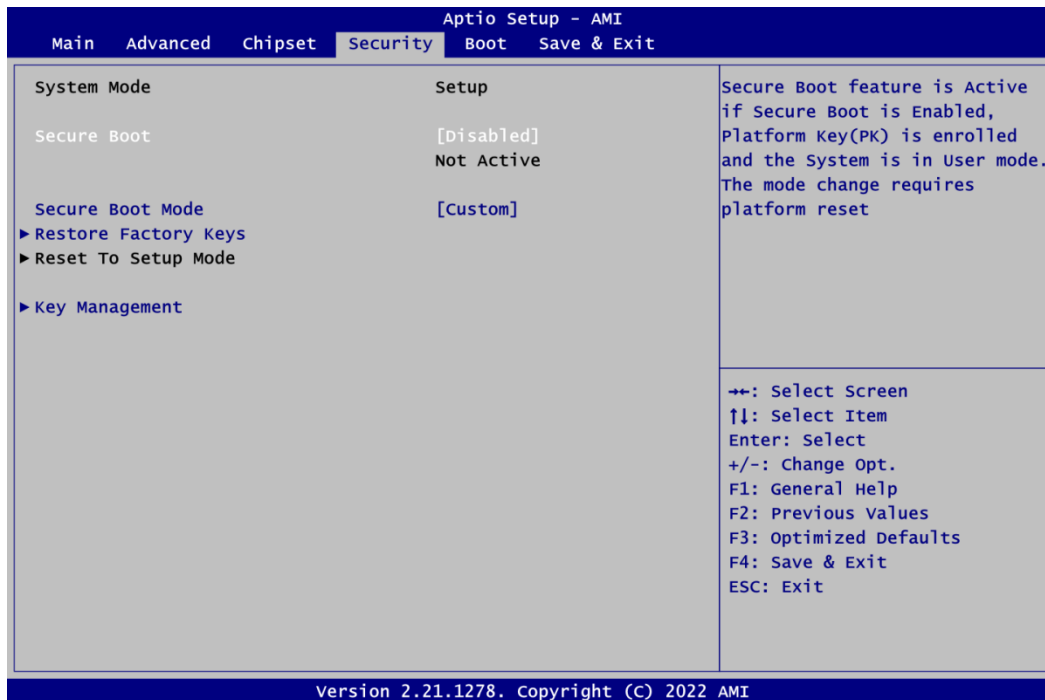

Secure Boot feature is Active if Secure Boot is Enabled, Platform Key (PK) is enrolled and the System is in User mode. The mode change requires platform reset.

Secure Boot Mode

Secure Boot mode options : Standard or Custom. In Custom mode, Secure Boot Policy variables can be configured by a physically present user without full authentication.

Restore Factory Keys

Force the system into User Mode. Install factory default Secure Boot key databases.

Key Management

Enables expert users to modify Secure Boot Policy variables without full authentication.

4.7 Boot Menu

The Boot menu allows users to change boot options of the system.

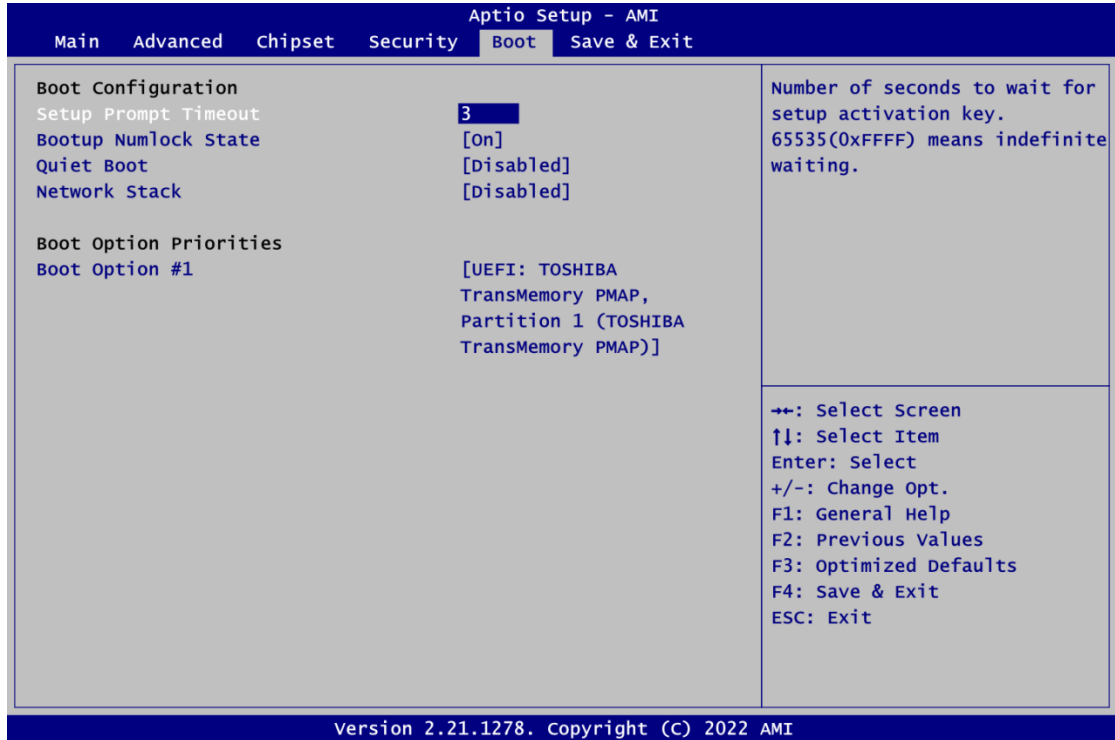

- Setup Prompt Timeout**
 Number of seconds to wait for setup activation key. 65535(0xFFFF) means indefinite waiting.
- Bootup NumLock State**
 Use this item to select the power-on state for the keyboard NumLock.
- Quiet Boot**
 Select to display either POST output messages or a splash screen during boot-up.
- Network Stack**
 Enable or disable UEFI Network stack.
- Boot Option Priorities**
 These are settings for boot priority. Specify the boot device priority sequence from the available devices.

4.8 Save & Exit Menu

The Save & Exit menu allows users to load your system configuration with optimal or fail-safe default values.

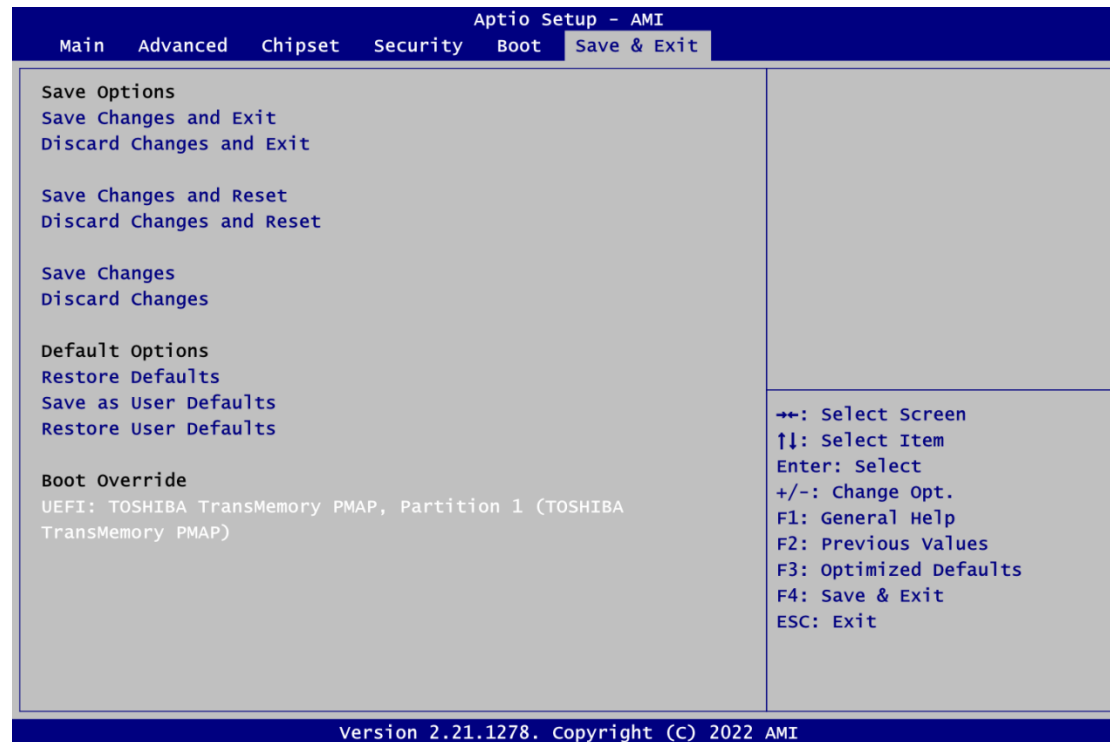

- Save Changes and Exit**
 When you have completed the system configuration changes, select this option to leave Setup and return to Main Menu. Select Save Changes and Exit from the Save & Exit menu and press <Enter>. Select Yes to save changes and exit.
- Discard Changes and Exit**
 Select this option to quit Setup without making any permanent changes to the system configuration and return to Main Menu. Select Discard Changes and Exit from the Save & Exit menu and press <Enter>. Select Yes to discard changes and exit.
- Save Changes and Reset**
 When you have completed the system configuration changes, select this option to leave Setup and reboot the computer so the new system configuration parameters can take effect. Select Save Changes and Reset from the Save & Exit menu and press <Enter>. Select Yes to save changes and reset.
- Discard Changes and Reset**
 Select this option to quit Setup without making any permanent changes to the system configuration and reboot the computer. Select Discard Changes and Reset from the Save & Exit menu and press <Enter>. Select Yes to discard changes and reset.
- Save Changes**
 When you have completed the system configuration changes, select this option to save changes. Select Save Changes from the Save & Exit menu and press <Enter>. Select Yes to save changes.

- **Discard Changes**
Select this option to quit Setup without making any permanent changes to the system configuration. Select Discard Changes from the Save & Exit menu and press <Enter>. Select Yes to discard changes.
- **Restore Defaults**
It automatically sets all Setup options to a complete set of default settings when you select this option. Select Restore Defaults from the Save & Exit menu and press <Enter>.
- **Save as User Defaults**
Select this option to save system configuration changes done so far as User Defaults. Select Save as User Defaults from the Save & Exit menu and press <Enter>.
- **Restore User Defaults**
It automatically sets all Setup options to a complete set of User Defaults when you select this option. Select Restore User Defaults from the Save & Exit menu and press <Enter>.
- **Boot Override**
Select a drive to immediately boot that device regardless of the current boot order.

Appendix A

Watchdog Timer

A.1 About Watchdog Timer

After the system stops working for a while, it can be auto-reset by the watchdog timer. The integrated watchdog timer can be set up in the system reset mode by program.

A.2 How to Use Watchdog Timer

Assembly sample code :

```
mov     dx,fa10           ; 5 seconds (Maximum is 65535 seconds; fill in
                        ; 0xFA10 and 0xFA11 register, ex: 0xFA11=0x01,
                        ; 0xFA10=0x68 means 360 seconds)
mov     al,05
out     dx,al

mov     dx,fa12           ; Enable WDT
mov     al,01
out     dx,al
```

This page is intentionally left blank.

Appendix B

Digital I/O

B.1 About Digital I/O

The onboard GPIO or digital I/O has 8 bits (DIO0~7). Each bit can be set to function as input or output by software programming. In default, all pins are pulled high with +5V level (according to main power). The BIOS default settings are 4 inputs and 4 outputs.

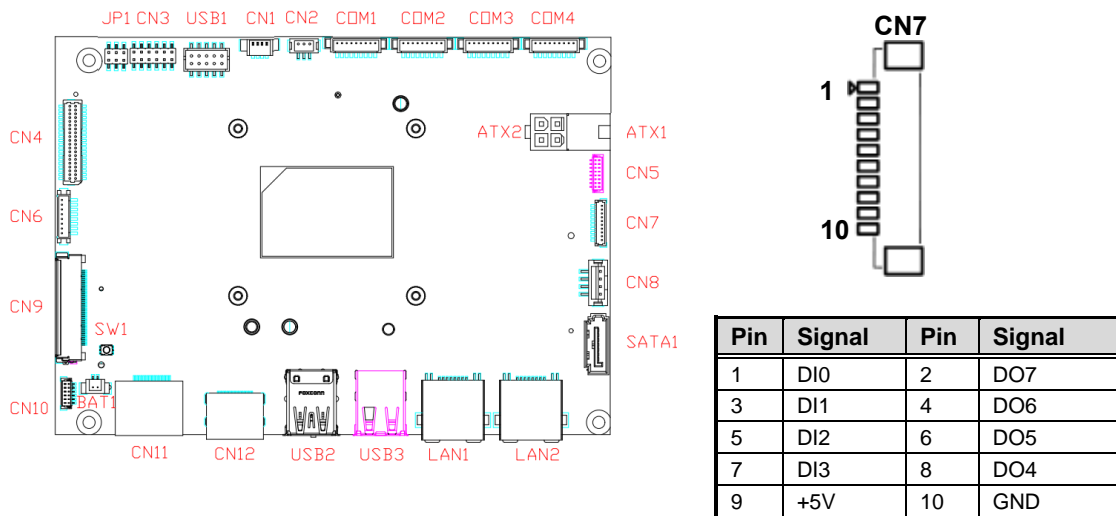

B.2 Digital I/O Programming

Assembly sample code :

```

mov    dx,fa18          ; Set DIO 0-7 to Output
mov    al,00
out    dx,al

mov    dx,fa19          ; Set DIO 4-7 to High
mov    al,f0
out    dx,al

mov    dx,fa18          ; Set DIO 0-7 to Input
mov    al,ff
out    dx,al

mov    dx,fa19          ; Get DIO 0-7 status
in     al,dx

mov    dx,fa18          ; Set DIO 0-4 to Input, 5-7 to Output
mov    al,1f            ; al = 1F => 00011111
out    dx,al

mov    dx,fa19          ; Set DIO 6 to High
mov    al,40            ; al = 40 => 01000000
out    dx,al

in     al,dx            ; Get DIO 0-7 status

```