

# Lantech

---

## T(P)GS-0008CB

8 10/100/1000T Unmanaged (PoE at/af) Ethernet Switch

## T(P)ES-0008CB

8 10/100TX Unmanaged (PoE at/af) Ethernet Switch

### User Manual



V1.01

Feb. 2024

### Notice

Only 24VDC input system is applicable for E-mark approval.

The unmanaged PoE Ethernet switch is equipped with P.S.E capacity. It is designed for data communication within vehicles, to facilitate data transfer and Ethernet connectivity as well as expandability. It's important to note that these features have no impact on the safety of driving and passenger well-being and the device does not possess any immunity-related functionalities.

## Approval Information

<b>Version 1.01</b>	<b>Name</b>	<b>Title</b>	<b>Date</b>
<b>Author</b>	Greg Tsai	Marketing	2024.02.29
<b>Verifier</b>	Jacky Chou	HW QA	2024.02.29
<b>Approver</b>	Thomas Lee	RD head	2024.02.29

<b>Version</b>	<b>Date</b>	<b>Content of Modification</b>	<b>Author(s)</b>
<b>V1.00</b>	2023.10.31		Greg Tsai
<b>V1.01</b>	2024.02.29	Update the spec of PoE budget.	Greg Tsai

## Recommendation for Shielded network cables

STP cables have additional shielding material that is used to reduce external interference. The shield also reduces the emission at any point in the path of the cable. Our recommendation is to deploy an STP network cable in demanding electrical environments. Examples of demanding indoor environments are where the network cable is located in parallel with electrical mains supply cables or where large inductive loads such as motors or contactors are in close vicinity to the camera or its cable. It is also mandatory to use an STP cable where the power device (like IP camera) is used outdoors or where the network cable is routed outdoors.



## **Important Notice**

Lantech Communications Global, Inc. reserves the right to modify the equipment, its specification or this manual without prior notice, in the interest of improving performance, reliability, or servicing. At the time of publication all data is correct for the operation of the equipment at the voltage and/or temperature referred to. Performance *data* indicates typical values related to the particular product.

No part of this documentation or information supplied may be divulged to any third party without the express written consent of Lantech Communications Global Inc. Products offered may contain software which is proprietary to Lantech Communications Global Inc. The offer or supply of these products and services does not include or infer any transfer of ownership.

## **Interference Issues**

This Equipment has been tested and found to comply with the limits for a Class A digital device, pursuant to Part 15 of the FCC rules. These limits are designed to provide reasonable protection against harmful interference in a commercial or industrial installation. This equipment generates, uses, and can radiate radio frequency energy. It may cause harmful interference to radio communications if the equipment is not installed and used in accordance with the instructions.

## **FCC Warning**

This Equipment has been tested and found to comply with the limits for a Class-A digital device, pursuant to Part 15 of the FCC rules. These limits are designed to provide reasonable protection against harmful interference in a residential installation. This equipment generates, uses, and can radiate radio frequency energy. It may cause harmful interference to radio communications if the equipment is not installed and used in accordance with the instructions. However, there is no guarantee that interference will not occur in a particular installation. If this equipment does cause harmful interference to radio or television reception, which can be determined by turning the equipment off and on, the user is encouraged to try to correct the interference by one or more of the following measures:

- Reorient or relocate the receiving antenna.
- Increase the separation between the equipment and receiver.
- Connect the equipment into an outlet on a circuit different from that to which the receiver is connected.
- Consult the dealer or an experienced radio/TV technician for help.

## **CE Mark Warning**

This is a Class-A product. In a domestic environment this product may cause radio interference in which case the user may be required to take adequate measures.

## **Content**

<b>Chapter 1</b>	<b>Introduction.....</b>	<b>6</b>
<b>Chapter 2</b>	<b>Hardware Description .....</b>	<b>7</b>
2.1	Physical Dimension .....	7
2.2	Package Content:.....	9
2.3	IP Protection .....	10
2.4	Front Panel .....	13
2.5	LED Indicators.....	14
<b>Chapter 3</b>	<b>Hardware Installation .....</b>	<b>15</b>
3.1	Wall mount installation.....	15
<b>Chapter 4</b>	<b>Connect Cable .....</b>	<b>17</b>
4.1	Power input M12 connector. ....	17
4.2	10/100TX interface M12 connector .....	21
4.3	10/100/1000T interface M12 connector ....	23
4.4	Ground interface M6 connector.....	25

# Chapter 1 Introduction

---

Lantech T(P)GS/ T(P)ES-0008CB Series are 8 10/100/1000T or 10/100 Base-TX with M12-connector unmanaged industrial switches for IP41 or IP54 rated protection, which meet the high reliability requirements demanded by industrial applications.

For latest product specifications, please refer to [Lantech official site](#).

# Chapter 2 Hardware Description

In this paragraph, it will describe the Industrial switch's hardware spec, port, cabling information, and wiring installation.

## 2.1 Physical Dimension

**T(P)GS-0008CB-54**

Aluminum case. IP-54, 135mm(W)x165mm(H)x76.5mm(D)

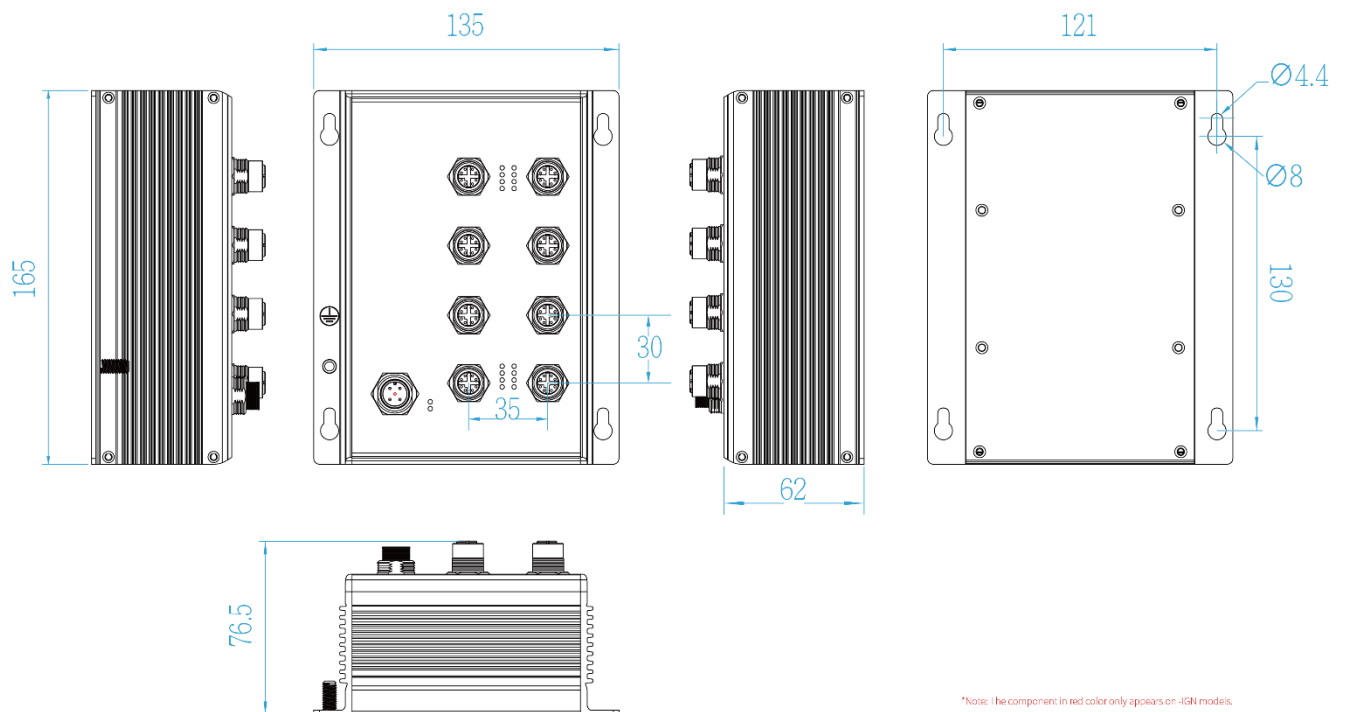

\*Note: The component in red color only appears on -IGN models.



**T(P)GS-0008CB-41**

Aluminum case. IP-41, 135mm(W)x165mm(H)x76mm(D)

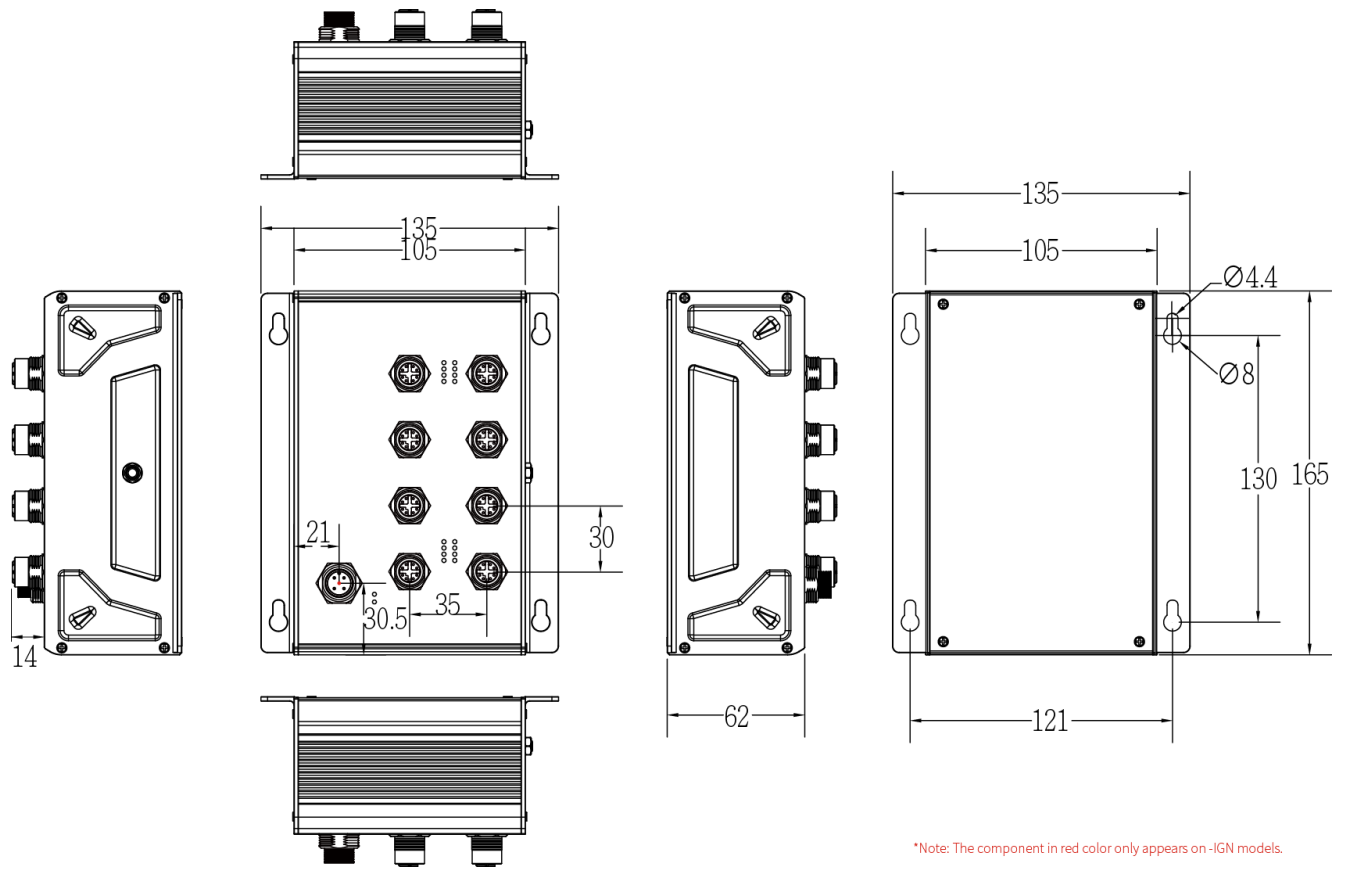

\*Note: The component in red color only appears on -IGN models.

**T(P)ES-0008CB-54**

Aluminum case. IP-54, 135mm(W)x165mm(H)x76.5mm(D)

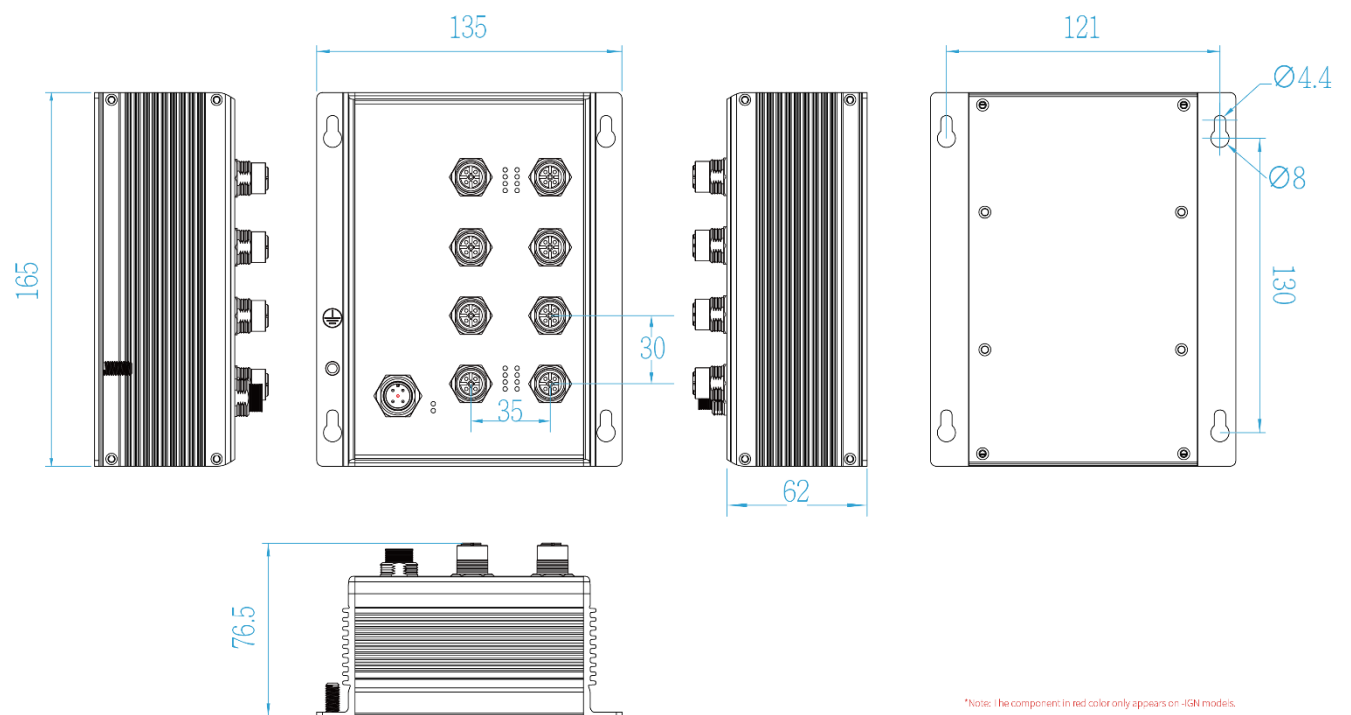

\*Note: The component in red color only appears on -IGN models.

## T(P)ES-0008CB-41

Aluminum case. IP-41, 135mm(W)x165mm(H)x76mm(D)

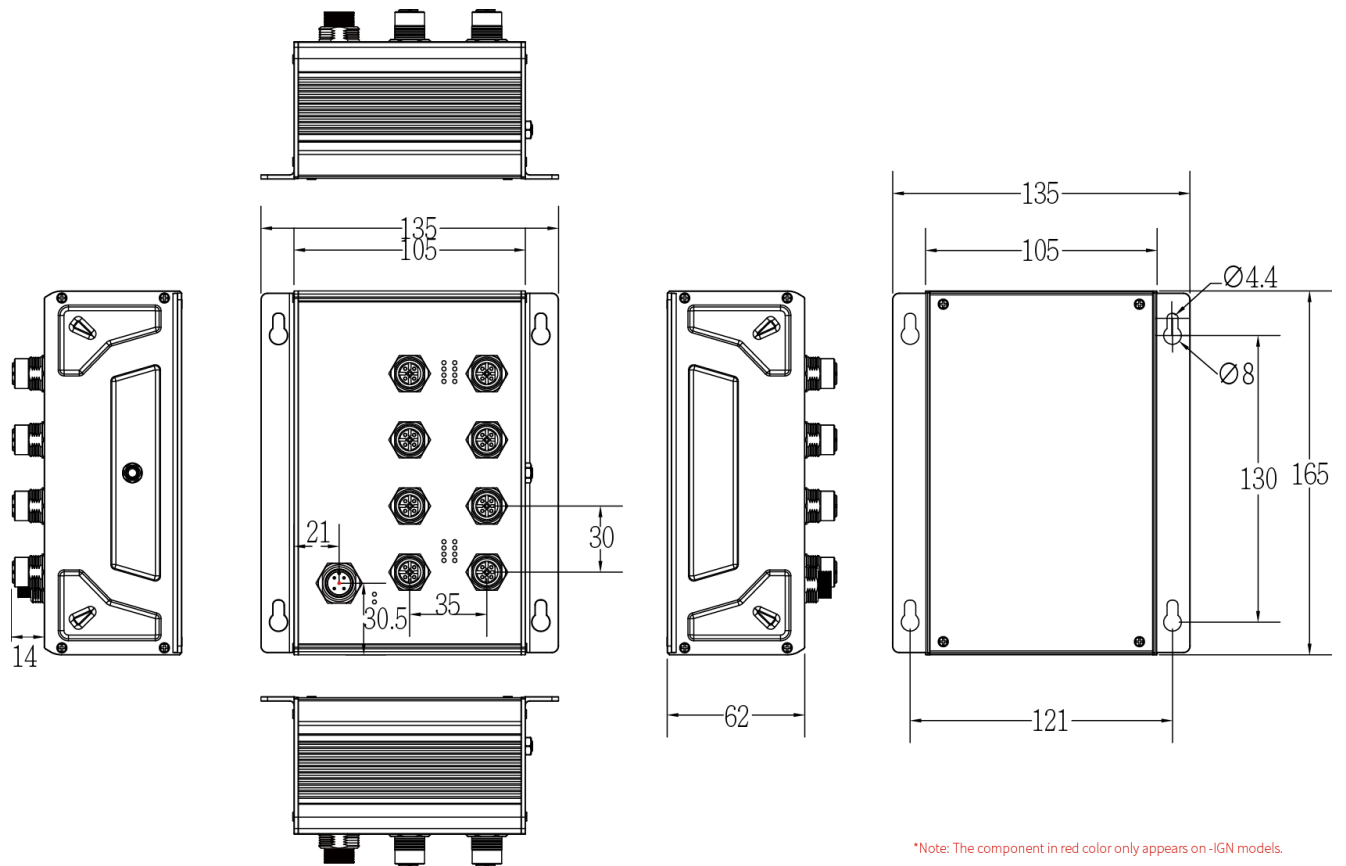

## 2.2 Package Content:

- Ethernet Switch
- Manual CD\*

\*By request

## 2.3 IP Protection

The **IP Code, Ingress Protection Rating**, sometimes also interpreted as **International Protection Rating**, classifies and rates the degree of protection provided against the intrusion (including body parts such as hands and fingers), dust, accidental contact, and water in *mechanical casings* and with electrical enclosures. It is published by the International Electrotechnical Commission (IEC)

Solid particle protection

The first digit indicates the level of protection that the enclosure provides against access to hazardous parts (e.g., electrical conductors, moving parts) and the ingress of solid foreign objects.

Level	Object size protected against	Effective against
0	—	No protection against contact and ingress of objects
1	>50 mm	Any large surface of the body, such as the back of a hand, but no protection against deliberate contact with a body part
2	>12.5 mm	Fingers or similar objects
3	>2.5 mm	Tools, thick wires, etc.
4	>1 mm	Most wires, screws, etc.
5	Dust protected	Ingress of dust is not entirely prevented, but it must not enter in sufficient quantity to interfere with the satisfactory operation of the equipment; complete protection against contact
6	Dust tight	No ingress of dust; complete protection against contact

## Liquid ingress protection

The second digit indicates the level of protection that the enclosure provides against harmful ingress of water.

<b>Level</b>	<b>Protected against</b>	<b>Testing for</b>	<b>Details</b>
<b>0</b>	Not protected	—	—
<b>1</b>	Dripping water	Dripping water (vertically falling drops) shall have no harmful effect.	Test duration: 10 minutes Water equivalent to 1 mm rainfall per minute
<b>2</b>	Dripping water when tilted up to 15°	Vertically dripping water shall have no harmful effect when the enclosure is tilted at an angle up to 15° from its normal position.	Test duration: 10 minutes Water equivalent to 3 mm rainfall per minute
<b>3</b>	Spraying water	Water falling as a spray at any angle up to 60° from the vertical shall have no harmful effect.	Test duration: 5 minutes Water volume: 0.7 litres per minute Pressure: 80–100 kPa
<b>4</b>	Splashing of water	Water splashing against the enclosure from any direction shall have no harmful effect.	Test duration: 5 minutes Water volume: 10 litres per minute Pressure: 80–100 kPa
<b>5</b>	Water jets	Water projected by a nozzle (6.3 mm) against enclosure from any direction shall have no harmful effects.	Test duration: at least 15 minutes Water volume: 12.5 litres per minute Pressure: 30 kPa at distance of 3 m

6	Powerful water jets	Water projected in powerful jets (12.5 mm nozzle) against the enclosure from any direction shall have no harmful effects.	Test duration: at least 3 minutes Water volume: 100 litres per minute Pressure: 100 kPa at distance of 3 m
7	Immersion up to 1 m	Ingress of water in harmful quantity shall not be possible when the enclosure is immersed in water under defined conditions of pressure and time (up to 1 m of submersion).	Test duration: 30 minutes Immersion at depth of at least 1 m measured at bottom of device, and at least 15 cm measured at top of device
8	Immersion beyond 1 m	The equipment is suitable for continuous immersion in water under conditions which shall be specified by the manufacturer. Normally, this will mean that the equipment is hermetically sealed. However, with certain types of equipment, it can mean that water can enter but only in such a manner that it produces no harmful effects.	Test duration: continuous immersion in water Depth specified by manufacturer
9	Powerful high temperature water jets	Protected against close-range high pressure, high temperature spray downs.	—

## 2.4 Front Panel

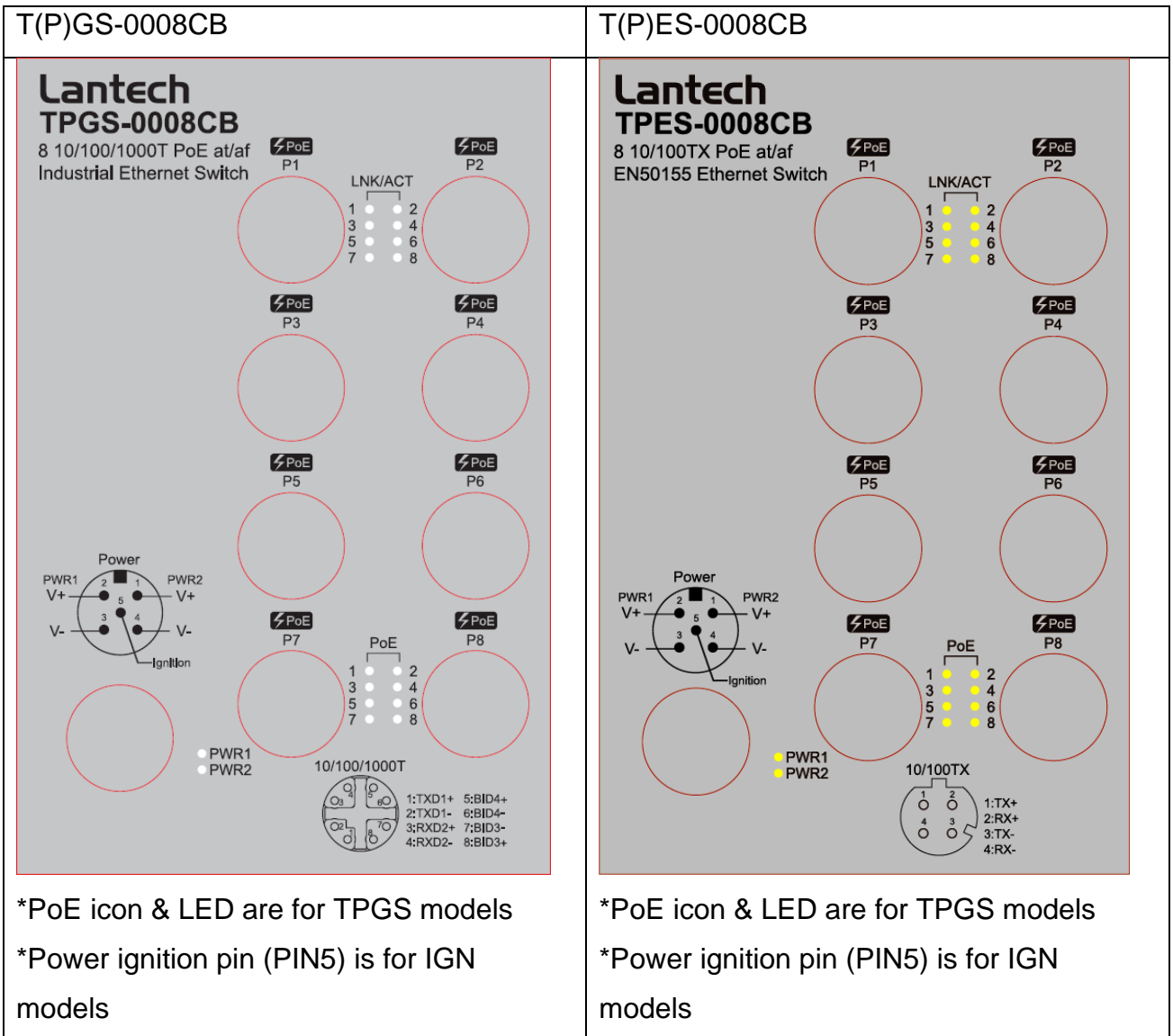

## 2.5 LED Indicators

The diagnostic LEDs that provide real-time information of system and optional status are located on the front panel of the industrial switch. The following table provides the description of the LED status and their meanings for the switch.

LED	Color	Status	Meaning
PWR1	Green	On	Power 1 is active
		Off	Power 1 is inactive
PWR2	Green	On	Power 2 is active
		Off	Power 2 is inactive
P1 ~ P8 LNK/ACT	Green	On	A network device is detected.
		Blinking	The port is transmitting or receiving packets from the TX device.
		Off	No device attached
P1 ~ P8 PoE (PoE model)	Green	On	The port is operating in PoE mode. (PoE model)
		Off	The port is not operating in PoE mode. (PoE model)

# Chapter 3 Hardware Installation

---

There are no mechanically active moving parts in the switch, to fix the switch into an installation position, please use M4 size screw and corresponding nut and standard M4 screwdriver to install switch in the field.

## 3.1 Wall mount installation

Please make sure the screw diameter is M4.

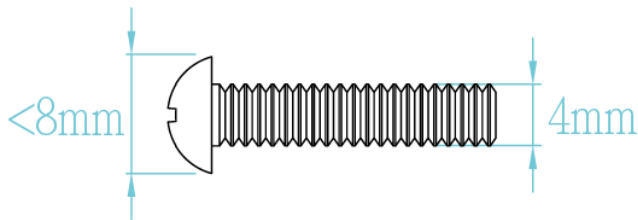

Check all 4 fix holes on the switch and find corresponding position in the wall .Use the appropriate tool to drill 4 holes onto the corresponding position, make sure the diameter of holes is compatible with the M4 screws, fix the 4 screws into these 4 holes but don't screw tightly, in order to have enough space to mount the switch.

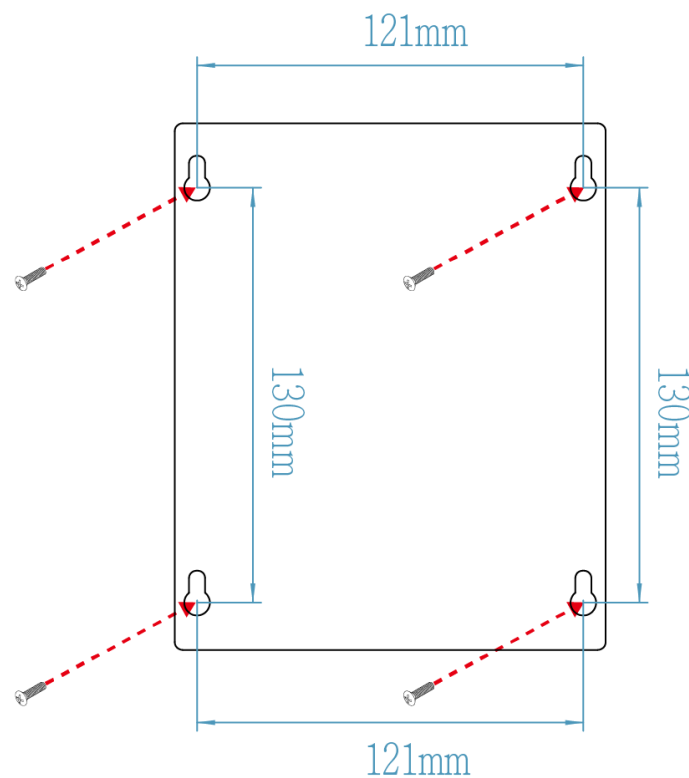



Mount switch in wall with 4 fixed screws.

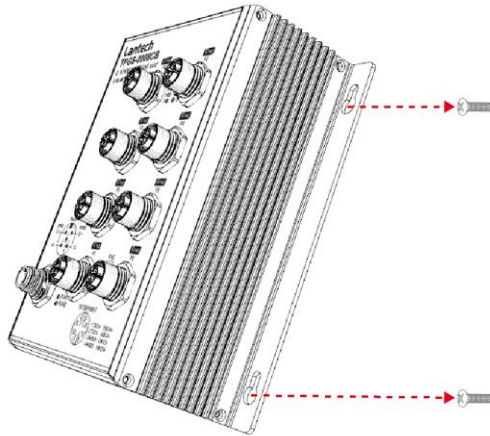

Attach switch in wall with 4 screws

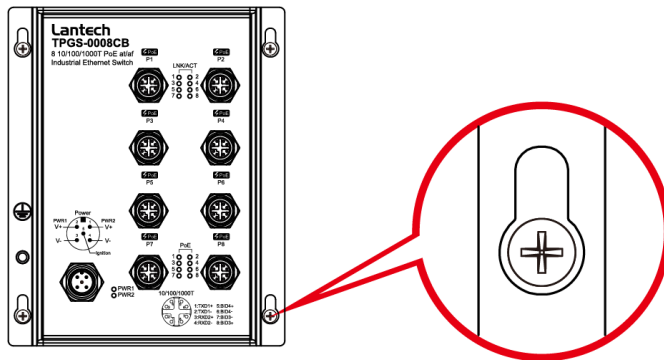

Move down

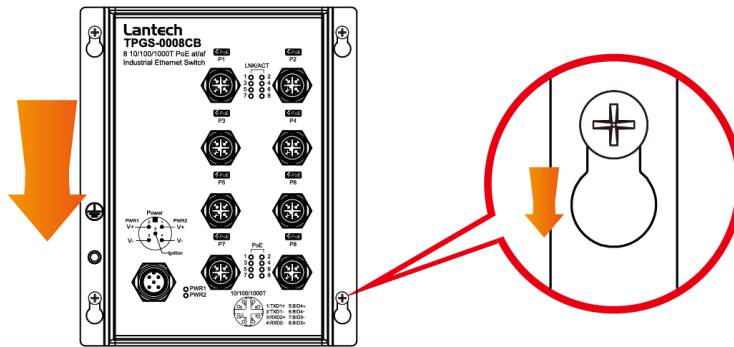

Tighten 4 screws

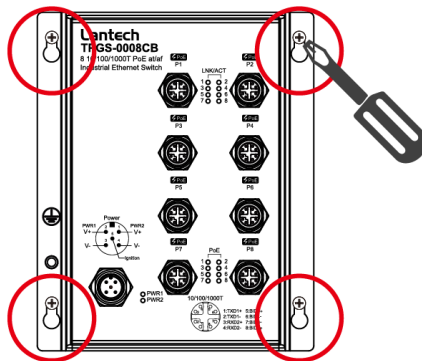

# Chapter 4 Connect Cable

---

 **Notice**  
Correctly connecting the grounding cable is crucial to lightning protection and EMI protection. To avoid damages caused by surge or EFT, using STP cable is highly suggested.

After the hardware installation is complete, please connect the cable to the switch. All the external interfaces use M12 connector design and follow IEC 61076 standard.

## 4.1 Power input M12 connector.

**Note:** Please check the power connector has been connected to the switch correctly before you turn on the power resource.

Connect the M12 connector of power input. The power supply for the series is connected via a 5-pole M12 male connector or a 4-pole M12 male connector.

■ Voltage of Power Input & PoE budget

Model	Power input	PoE budget
24TVI models	Dual 16.8~56VDC	80W@24V (For PoE models)
24VI models	Dual 9~36VDC	

Please make sure that the external power supply unit you use to provide the PoE voltage meet the following criteria:

- The power consumption can satisfy the total power request from all PD devices required.

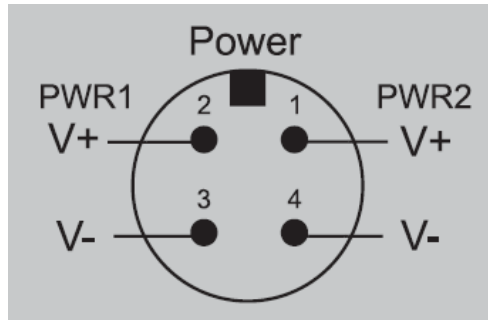

Pin assignment of Power input (Standard models)

- Pin assignment of optional power cable ECONM12-4P(F)1.5M

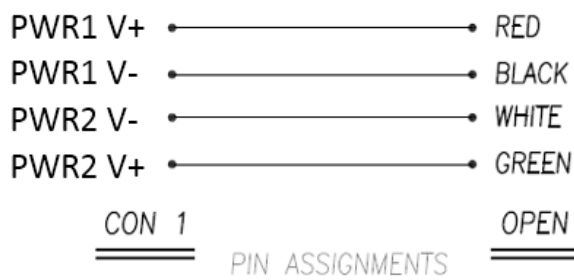

\*The color is based on the optional power cable of Lantech.

- Make sure the direction of connector is correct before you connect it.

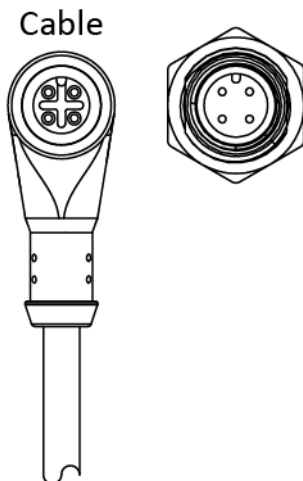

- Plug power connector and screw in clockwise direction to fix it.

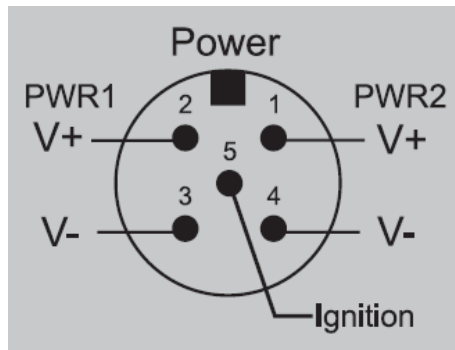
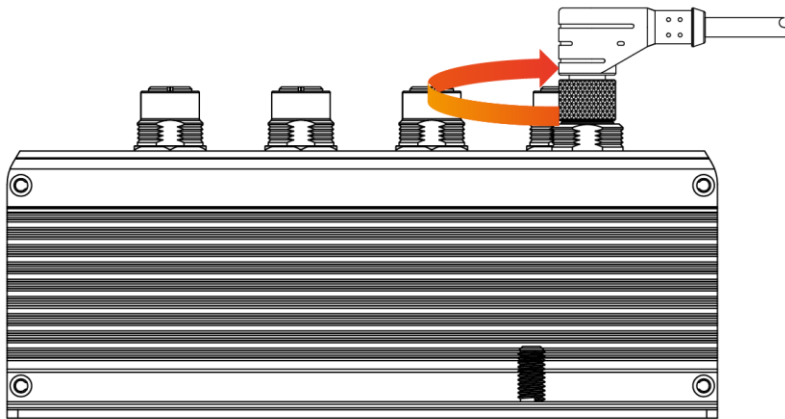
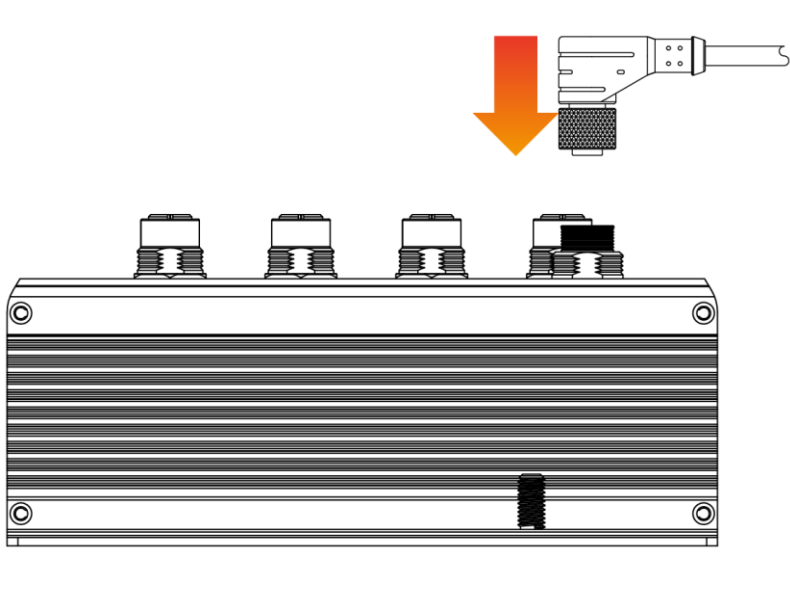

Pin assignment of Power input (IGN models)

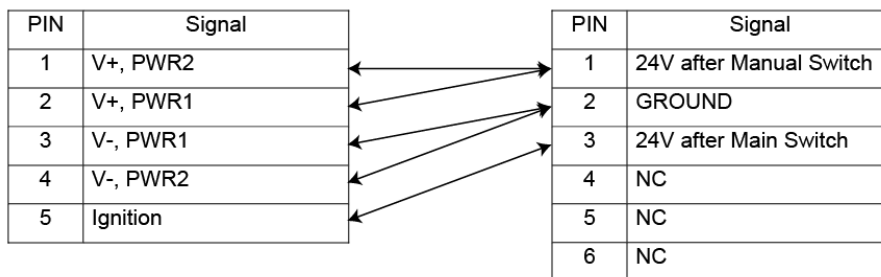

ECONM12-05A(F) to MCP 6P-20CM CABLE  
(Optional power cable for IGN models)

- This male connector installed at vehicle side is MCP type connector with 6 pins, TYCO reference: 8-968970-1 Blue Code A.
  - Ignition

When the vehicle has been stalled by the driver, some equipment in the car may still need to run for a while. With Lantech ignition switch, even if the engine of the vehicle has been turned off by driver, the switch can still offer power to the equipment via PoE connection from the battery.

The ignition pin must connect to driver power / main key with voltage 9~36VDC before you turn on the power resource. The switch will not turn on without proper voltage range with the ignition model.

- Redundant Power Input

The power input can be supported redundantly. The supply voltage is electrically isolated from the housing.

**Note:** With single power supply of the mains voltage, the device will report a power failure. You can disable this power fail event via web browser.

## 4.2 10/100TX interface M12 connector

- Pin assignment of the 10/100Tx port

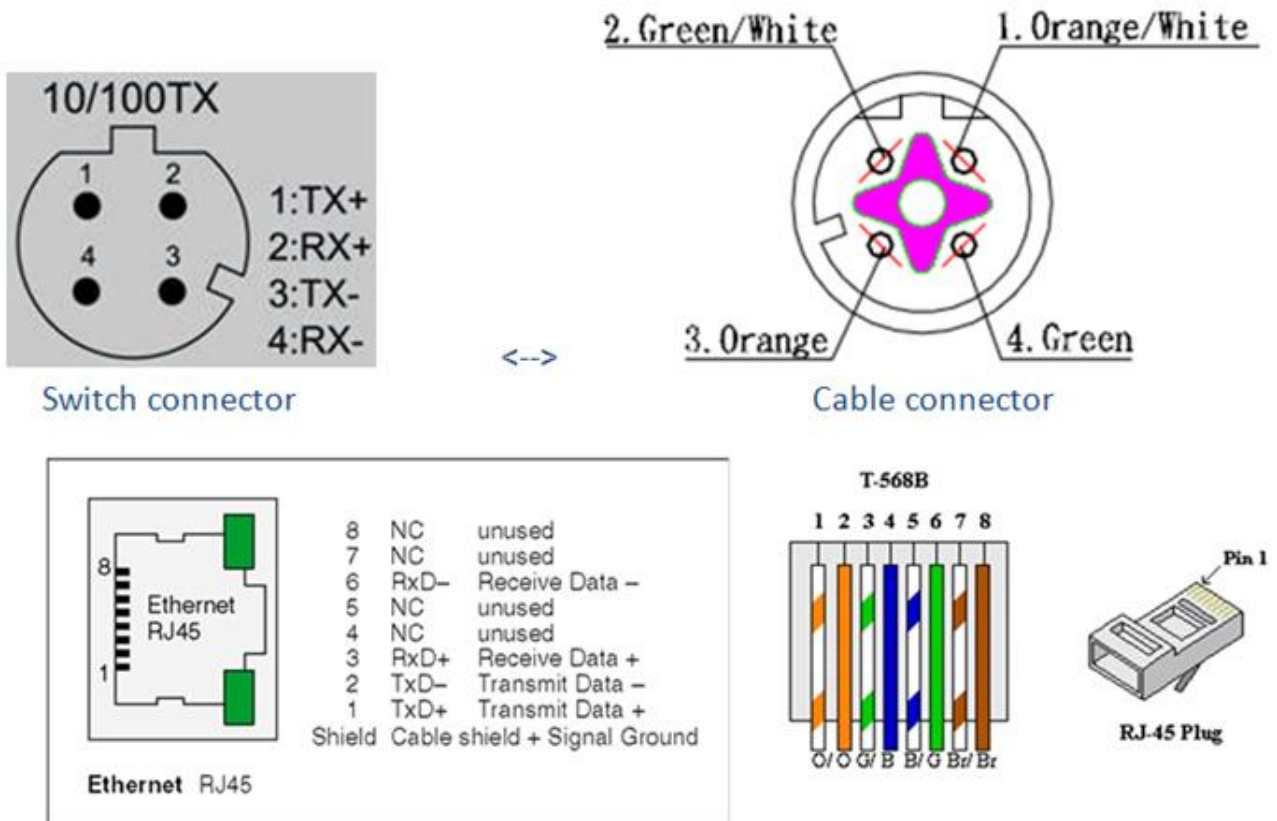

- Make sure the direction of connector is correct before you connect it.

### Cable

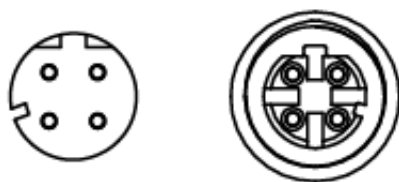

- Plug the 10/100Tx connector and screw in clockwise direction to fix it.

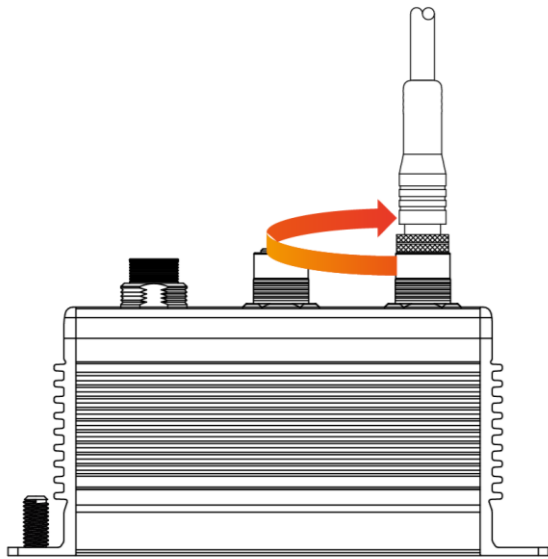
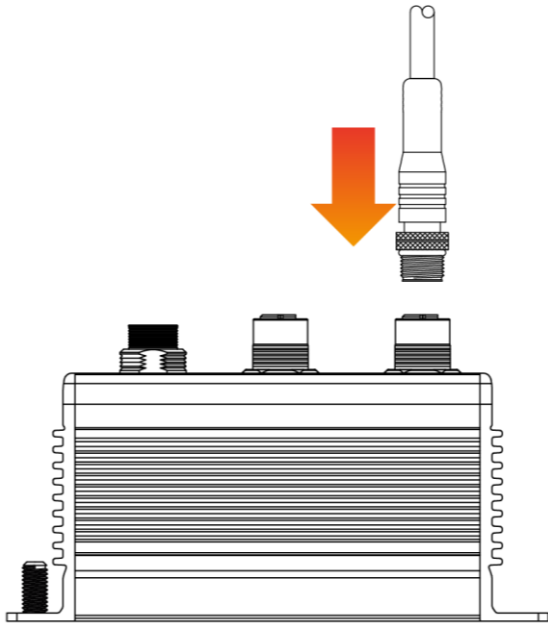

### 4.3 10/100/1000T interface M12 connector

- Pin assignment of the 10/100/1000T port

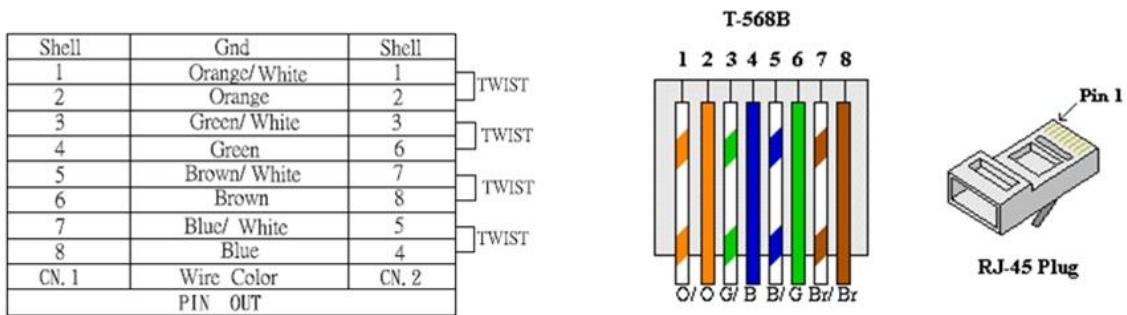
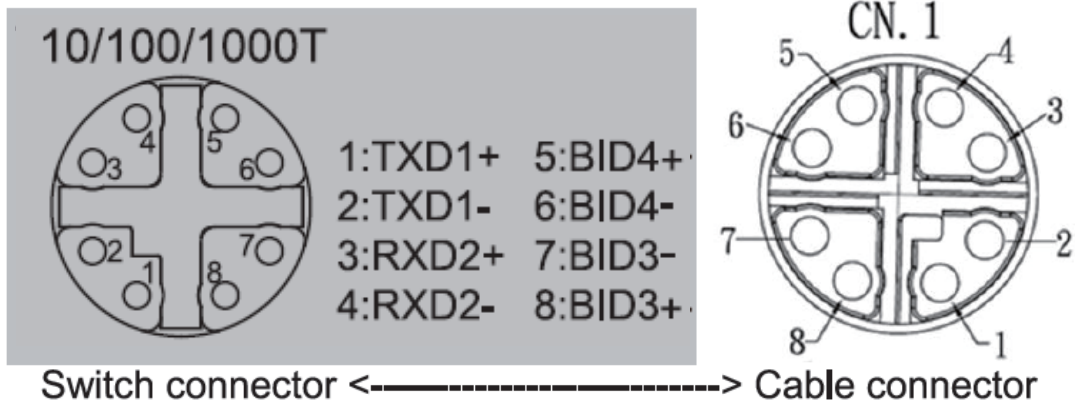

- Make sure the direction of connector is correct before you connect it.

### Cable





- Plug the connector and screw in clockwise direction to fix it.

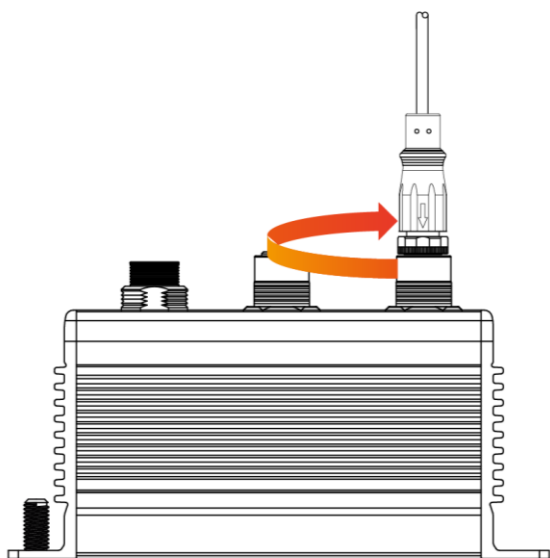
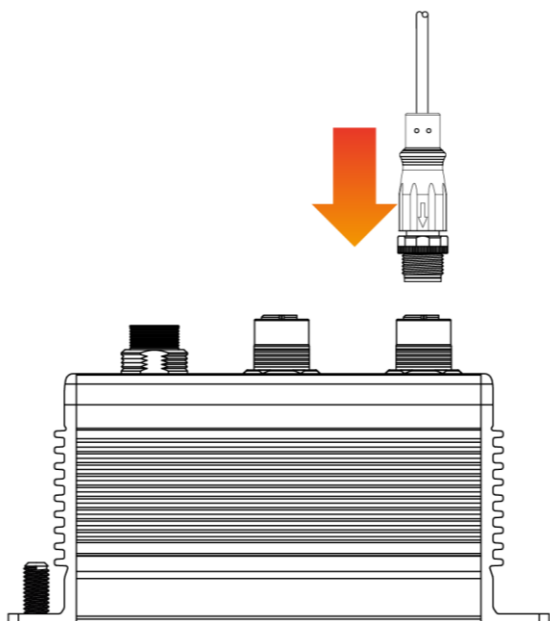

## 4.4 Ground interface M6 connector

### ■ Ground – IP54 model

The chassis is grounded via a separate ground nut (M6).

Use toothed locking washers for a good electrical connection.



Ground screw of IP54 model

### ■ Ground – IP41 model

The chassis is grounded via a separate ground nut (M3).

Use toothed locking washers for a good electrical connection.

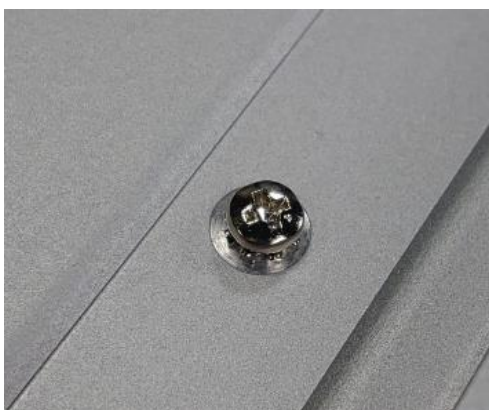

Ground screw of IP41 model

**\*Note:** The torque should not be over 14 kilogram-force centimeter (kgf-cm). Using torque over 14 kgf-cm may cause damage to the grounding parts.

**Note:**

- The protection class IP41/IP54 is only achieved when bolted together.
- The other components attaching to the system have to meet with the IP41/IP54 protection class in order to reach the whole system IP41/IP54 protection.
- Empty ports must be sealed with the protective caps supplied.

**=====Notice=====**

Please contact [support@lantechcom.tw](mailto:support@lantechcom.tw) for more information.