

# USER'S MANUAL

## **NA870 series**

**Network Appliance**

**User's Manual**



[www.axiomtek.com](http://www.axiomtek.com)

## **Disclaimers**

This manual has been carefully checked and believed to contain accurate information. Axiomtek Co., Ltd. assumes no responsibility for any infringements of patents or any third party's rights, and any liability arising from such use.

Axiomtek does not warrant or assume any legal liability or responsibility for the accuracy, completeness or usefulness of any information in this document. Axiomtek does not make any commitment to update the information in this manual.

Axiomtek reserves the right to change or revise this document and/or product at any time without notice.

No part of this document may be reproduced, stored in a retrieval system, or transmitted, in any form or by any means, electronic, mechanical, photocopying, recording, or otherwise, without the prior written permission of Axiomtek Co., Ltd.

## **CAUTION**

If you replace wrong batteries, it causes the danger of explosion. It is recommended by the manufacturer that you follow the manufacturer's instructions to only replace the same or equivalent type of battery, and dispose of used ones.

**©Copyright 2022 Axiomtek Co., Ltd.**

**All Rights Reserved**

**July 2022, Version A1**

**Printed in Taiwan**

## Safety Approvals

◆ CE Marking

◆ FCC Class A

### ◆ FCC Compliance

This equipment has been tested and complies with the limits for a Class A digital device, pursuant to Part 15 of the FCC Rules. These limits are designed to provide reasonable protection against harmful interference in a residential installation. If not installed and used in accordance with proper instructions, this equipment might generate or radiate radio frequency energy and cause harmful interference to radio communications. However, there is no guarantee that interference will not occur in a particular installation. If this equipment does cause harmful interference to radio or television reception, which can be determined by turning the equipment off and on, the user is encouraged to try to correct the interference by one or more of the following measures:

- Reorient or relocate the receiving antenna.
- Increase the separation between the equipment and receiver.
- Connect the equipment into an outlet on a circuit different from that to which the receiver is connected.
- Consult the dealer or an experienced radio/TV technician for help.
- Shielded interface cables must be used in order to comply with emission limits.

## Safety Precautions

Before getting started, read the following important cautions.

1. Be sure to ground yourself to prevent static charge when installing the internal components. Use a grounding wrist strap and place all electronic components in any static-shielded devices. Most electronic components are sensitive to static electrical charge.
2. Disconnect the power cords from the NA870 Series before making any installation. Be sure both the system and the external devices are turned OFF. Sudden surge of power could ruin sensitive components. Make sure the NA870 Series is properly grounded.
3. Do not open the system's top cover. If opening the cover for maintenance is a must, only a trained technician is allowed to do so. Integrated circuits on computer boards are sensitive to static electricity. To avoid damaging chips from electrostatic discharge, observe the following precautions:
  - Before handling a board or integrated circuit, touch an unpainted portion of the system unit chassis for a few seconds. This will help to discharge any static electricity on your body.
  - When handling boards and components, wear a wrist-grounding strap, available from most electronic component stores.

## Trademarks Acknowledgments

Axiomtek is a trademark of Axiomtek Co., Ltd.

Windows<sup>®</sup> is a trademark of Microsoft Corporation.

IBM, PC/AT, PS/2, VGA are trademarks of International Business Machines Corporation.

Intel<sup>®</sup> and Pentium<sup>®</sup> are trademarks of Intel Corporation.

AMI is trademark of American Megatrend Inc.

Other brand names and trademarks are the properties and registered brands of their respective owners.

# Table of Contents

---

<b>Disclaimers</b> .....	<b>ii</b>
<b>Safety Approvals</b> .....	<b>iii</b>
<b>Safety Precautions</b> .....	<b>iv</b>
<b>Section 1 Introduction</b> .....	<b>1</b>
<b>1.1 General Description</b> .....	<b>1</b>
<b>1.2 Features</b> .....	<b>1</b>
<b>1.3 Specifications</b> .....	<b>2</b>
<b>1.4 Dimensions and Outlines</b> .....	<b>5</b>
<b>1.5 I/O Outlets</b> .....	<b>6</b>
1.5.1 Front Panel.....	6
1.5.2 Rear Panel (N870) .....	8
<b>Section 2 Hardware and Installation</b> .....	<b>9</b>
<b>2.1 Check List</b> .....	<b>9</b>
<b>2.2 Board Layout</b> .....	<b>10</b>
<b>2.3 Jumper Settings for SBC8A870</b> .....	<b>13</b>
2.3.1 CMOS Clear Jumper (JP12) .....	13
2.3.2 BMC Config FAN Quantity Jumper (J5&J6&J7) for option .....	13
<b>2.4 Jumper Settings for AX93341</b> .....	<b>14</b>
2.4.1 TACT Switch Selection (JP1) .....	14
<b>2.5 Connectors</b> .....	<b>15</b>
2.5.1 ATX 2*4 pin +12V CPU Power Connector (CN11, CN12, CN13, CN14) ..	17
2.5.2 ATX 2*2 PIN ATX + +12V Power Connector (ATX1, ATX2) .....	17
2.5.3 Serial Port2 Connector (COM2) .....	17
2.5.4 M.2 M-key 2280 (CN23 ,CN18 default PCIe, SATA for option).....	18
2.5.5 ATX24 pin Power Connector (CN20) .....	19
2.5.6 LCM Connector (LCM1) .....	19
2.5.7 FIO Connector – USB3.0(CN21).....	20
2.5.8 FIO Connector – LAN1, LAN2 (CN26, CN28).....	20
2.5.9 Front Panel Bezel Connector (CN27) .....	21
2.5.10 Digital input/output Connector (CN29) .....	21
2.5.11 FAN Connectors (FAN1~FAN6) .....	22
2.5.12 PMBUS connector (PMBUS1).....	22
2.5.13 Serial ATA Connectors (SATA1-8) .....	22
2.5.14 USB2.0 Port Connector (USB1, USB2) .....	23
2.5.15 VGA pin header (VGA1).....	23
2.5.16 FIO Connector – COM/LED (COM1) .....	23
2.5.17 Serial Port1(For Console) Connector (COM1).....	24
2.5.18 Case open Connector (CN30).....	24
<b>2.6 Hardware Installation</b> .....	<b>25</b>

2.6.1	Install the CPU .....	25
2.6.2	Install the Memory .....	29
2.6.3	Install the Expansion Slot (optional).....	31
<b>Section 3</b>	<b>AMI BIOS Setup Utility .....</b>	<b>33</b>
<b>3.1</b>	<b>Starting .....</b>	<b>33</b>
<b>3.2</b>	<b>Navigation Keys.....</b>	<b>33</b>
<b>3.3</b>	<b>Main Menu .....</b>	<b>35</b>
<b>3.4</b>	<b>Advanced Menu .....</b>	<b>36</b>
<b>3.5</b>	<b>Platform Configuration .....</b>	<b>54</b>
<b>3.6</b>	<b>Socket Configuration .....</b>	<b>59</b>
<b>3.7</b>	<b>Security Menu .....</b>	<b>62</b>
<b>3.8</b>	<b>Boot Menu .....</b>	<b>63</b>
<b>3.9</b>	<b>Save &amp; Exit Menu.....</b>	<b>65</b>
<b>Appendix A</b>	<b>LAN Bypass Configuration .....</b>	<b>69</b>
<b>Appendix B</b>	<b>WDT Timer for System Reset .....</b>	<b>73</b>
<b>Appendix C</b>	<b>LAN Module Expansion.....</b>	<b>75</b>
<b>Appendix D</b>	<b>Warning .....</b>	<b>83</b>

# Section 1

## Introduction

This chapter contains general information and detailed specifications of the NA870 Series Network Appliance Server. It contains the following sections:

- General Description
- Features
- Specifications
- Dimensions and Outlines
- I/O Outlets

### 1.1 General Description

The NA870 is a 2U rack mountable network security hardware platform for VPN, firewall and other network security applications. It supports Dual LGA4189 socket 3rd gen Intel® Xeon scalable processors and Intel® C621A chipset with twenty DDR4-3200 RDIMM memory up to 1280GB.

For storing event log data, the NA870 utilizes two 2.5" SATA HDD. For greater flexibility and easier maintenance, the NA870 has eight front-accessible expansion slots that allow developers to configure different LAN modules based on their solution requirements.

The NA870 is designed especially for enterprise sized business. NA870 not only provides high performance processor, memory, storage interface and LAN connection, but also includes outstanding management capability.

### 1.2 Features

- 3rd gen Intel® Dual Xeon processor Scalable Family (Ice Lake-SP) Socket LGA4189
- Twenty DDR4-3200 R-DIMM for up to 1280GB of memory
- Supports eight LAN modules expansion
- Supports BIOS redirected to COM port
- Supports two 2.5" SATA HDD (hot swappable)
- Supports hot-swappable system Fan
- Suitable for VPN, network bandwidth controller, firewall applications
- Supports redundant power

## 1.3 Specifications

### System

- **System CPU**
  - Intel Dual LGA4189 socket 3rd gen Intel® Xeon scalable processors (Ice Lake-SP)
- **System Chipset**
  - Intel Dual LGA4189® C621 Intel® C621A in default /C627A by project
- **System Memory**
  - Twenty DIMM Socket support DDR4 RDIMM 3200 max up to 1280GB.
- **BIOS**
  - AMI 256Mbit PnP Flash BIOS with function of BIOS redirected to COM port
- **HDD Tray**
  - Two 2.5" Trays for SATA HDD, support hot swappable.
- **LAN**
  - Two GbE RJ-45 (2xIntel® i210AT, one port will be shared for IPMI for optional)
  - Single CPU: 4 x LAN module (optional), max. up to 34 LAN ports
  - Dual CPU: 8 x LAN module (optional), max. up to 66 LAN ports
- **LAN module**

	Module	LAN Chipset	Ports	LAN Bypass (Latch Relay)	Copper/Fiber
1G	AX93316-8GIL	Intel® i350	8	4	8/0
	AX93326-8GIL	Intel® i210	8	4	8/0
	AX93316-8GI	Intel® i350	8	0	8/0
	AX93322-8MIL	Intel® i350	8	2	4/4
	AX93322-8FI	Intel® i350	8	0	0/8
	AX93336-4GIL	Intel® i350	4	2	4/0
	AX93336-4FI	Intel® i350	4	0	0/4
10G	AX93327-4FI	Intel® XL710	4	0	0/4
	AX93307-2FI	Intel® 82599ES	2	0	0/2



	AX93307-2FIL	Intel® 82599ES	2	1	0/2
25G	AX93332-25FI	Intel® XXV710	2	0	0/2
40G	AX93331-2QFI	Intel® XL710	2	0	0/2
100G	AX93357- HFI((PCIex16)	Intel® E810	2	0	0/2
	AX93358-HFI (2xPCIex8 front)	Intel® E810	2	0	0/2

➤ **Limitation: Single CPU only supports 4 LAN modules (Slot 1~4)**



**Note:** NA870 can support total 8 slots of LAN module, but for the 100G LAN module, the maximum is limited to two modules, since the AX93358 occupies two slots.

- **SSD**
  - 2 x 2.5HDD hot swappable
  - One M.2 Key M 2242/2280 (PCIe)
  - One M.2 Key B 2242/2280 (SATA/PCIe)
  
- **I/O Interface**
  - One console connector (RJ-type)
  - Two USB3.0 connectors
  - Two RJ45 connectors
  - One VGA connector
  
- **Watchdog Timer**
  - 255 stepping for system reset
  - 8 stepping for LAN Bypass
  
- **Hardware Monitoring**
  - Controller Nuvoton NCT6102D+NCT7802Y
  - CPU temperature, system temperature, power and fan speed detection
  
- **Expansion Interface**
  - Two PCI Express\*16 Slots (Optional, 1 slot for each CPU) through riser card AX93350
  
- **Power Supply**
  - 1300W Redundant Power Supply
  
- **OS Compatibility**
  - Linux Kernel

## Mechanical/Environmental

- **Form Factor**
  - 2U rack mount
  
- **LED**
  - Power, HDD, GPIO LEDs and LAN bypass LEDs depend on LAN module.
  
- **Operation Temperature**
  - 0°C ~ 40°C (32°F ~ 104°F) for C621A
  - 5°C ~ 40°C (41°F ~ 104°F) for C627A
  
- **Humidity**
  - 10% - 95% RH, non-condensing
  
- **Chassis Material**
  - Steel
  
- **Dimensions**
  - 88mm (3.46") (H) x 430mm (16.92") (W) x 664mm (") (D)
  
- **Certificate**
  - FCC class A / CE class A



**Note:** All specifications and images are subject to change without notice.

### 1.4 Dimensions and Outlines

The following diagram shows you dimensions and outlines of the NA870 Series.

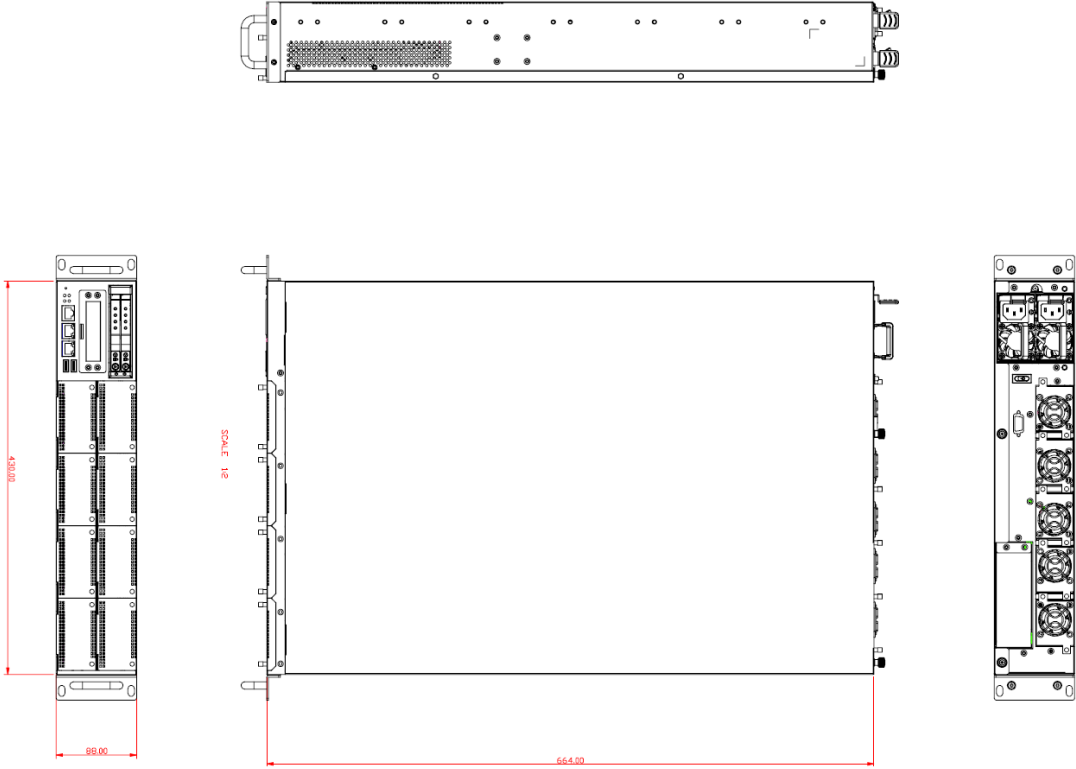

Default: 2 LAN ports / Expandable up to 66 LAN ports

## 1.5 I/O Outlets

Locate front and rear panel I/O outlets on the NA860 Series server to connect serial and Ethernet interface devices.

### 1.5.1 Front Panel

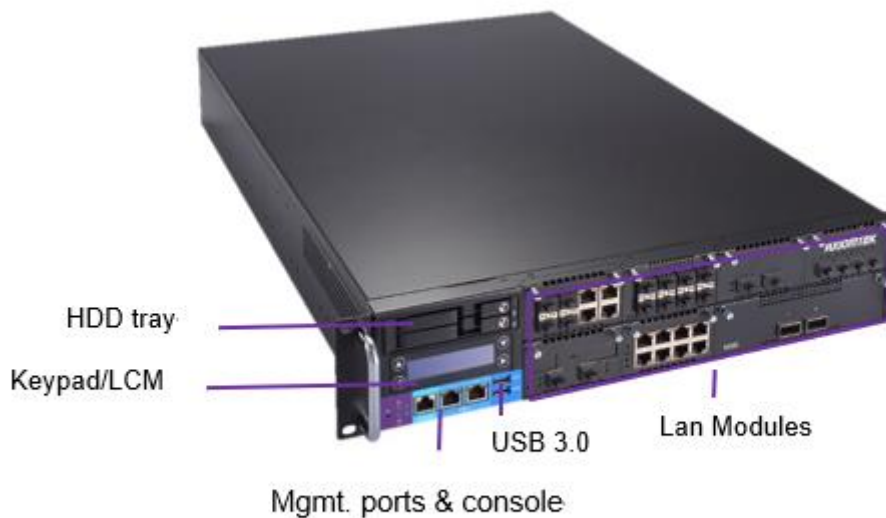

#### Front Side I/O

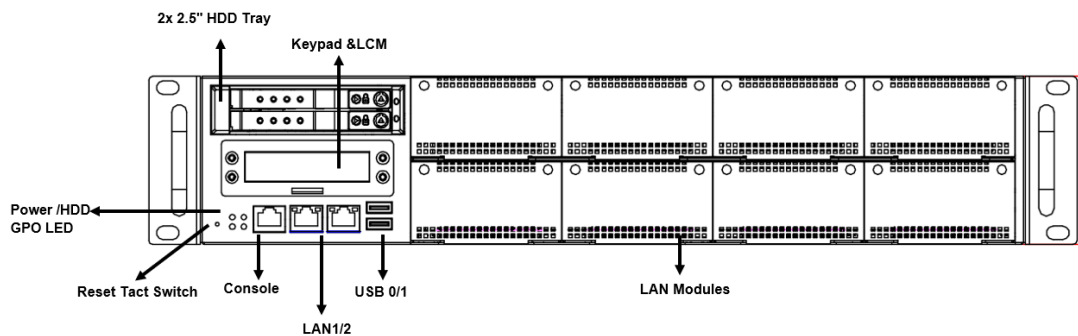

- **GPIO LEDs (Green)**  
The GPIO1 and GPIO2 LEDs are controlled by programmable GPIO. A sample code will be provided that allow users to define their own function.
- **HDD LED (Green)**  
LED flashes when HDD is transmitting or receiving data.
- **Power LED (Green)**  
LED flashes when the server is powered on to perform diagnostic tests and proper operation check.

- **Console Port**  
This is a RJ-type connector console port for command line interface and diagnostic support by P.O.S.T (Power On Self-Test).
- **USB Ports**  
Two USB 3.0 ports supported.
- **“Reset” Tact Switch (default)**  
It is for reset the system to reboot your computer instead of turning OFF the power switch. It is a better way to reboot your system for a longer life of the system's power supply, or GPI/power button by jumper setting.
- **Link LED for LAN port**  
The double-color LED light indicates 10/100/1000Mbps transfer rate.

LED Light Color	Transfer Rate
Dark	10Mbps
Green	100Mbps
Orange	1000Mbps

- If the LED is dark and Active/Link LED is lighting on flashing, the transfer rate should be 10Mbps.
  - When the green-color LED light is radiating, the transfer rate should be 100Mbps.
  - When the orange-color LED light is radiating, the transfer rate should be 1000Mbps.
  - When this LED and Link/Active LED both are dark, no networking devices are attached.
- **Active/Link LED for LAN Port**
    - The orange LED is on when the LAN port connection is working.
    - The LED flashes when transmitting or receiving any signals to or from the appliance.
    - The LED is dark when the appliance is off.



**Note:** *Optional LAN module LED definition in Appendix C.*

## 1.5.2 Rear Panel (N870)



### Rear Side I/O

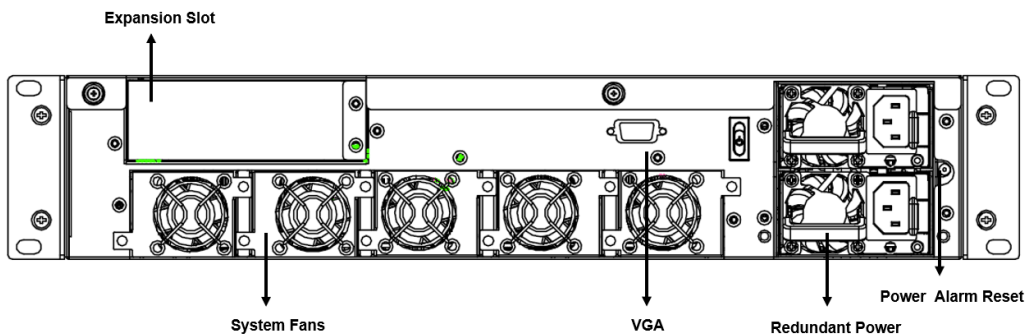

- **Power Supply**  
Redundant power supply; use power cord to connect this power supply to electrical outlet (AC) and also provide an alarm reset for power supply, when one of power has damage.
- **Power Alarm Reset**  
Alarm reset is used to clear fail status by shorting circuit activities. Buzzer should alarm if signal goes low.
- **VGA**  
This is a standard D-Sub connector commonly used for VGA display.
- **CPU & System Fan**  
These are fans for cooling down system & CPU temperature.
- **Expansion Slot (optional)**  
2 x PCIe x16 (Optional, 1 slot for each CPU) through riser card

## Section 2

# Hardware and Installation

The NA870 Series are convenient for your various hardware configurations. This chapter will help you get familiar with the hardware.

### 2.1 Check List

The package bundled with your NA870 Series should contain the following items:

- **The NA870 Series network appliance hardware platform**
- **Power cord x2 (redundant power 1+1)**
- **Mounting brackets for rack installation (left/right) x 2**
- **Screw for mounting bracket x4**
- **Plastic stand for stack-up x 4**
- **Console cable (RJ-type connector) x 1 for optional**
- **Passive CPU heat sink x2**
- **Processor Clip x2**

If you cannot find this package or any items are missing, please contact Axiomtek distributors immediately. If you order any optional components, the package might contain those additional hardware or documents accordingly.

## 2.2 Board Layout

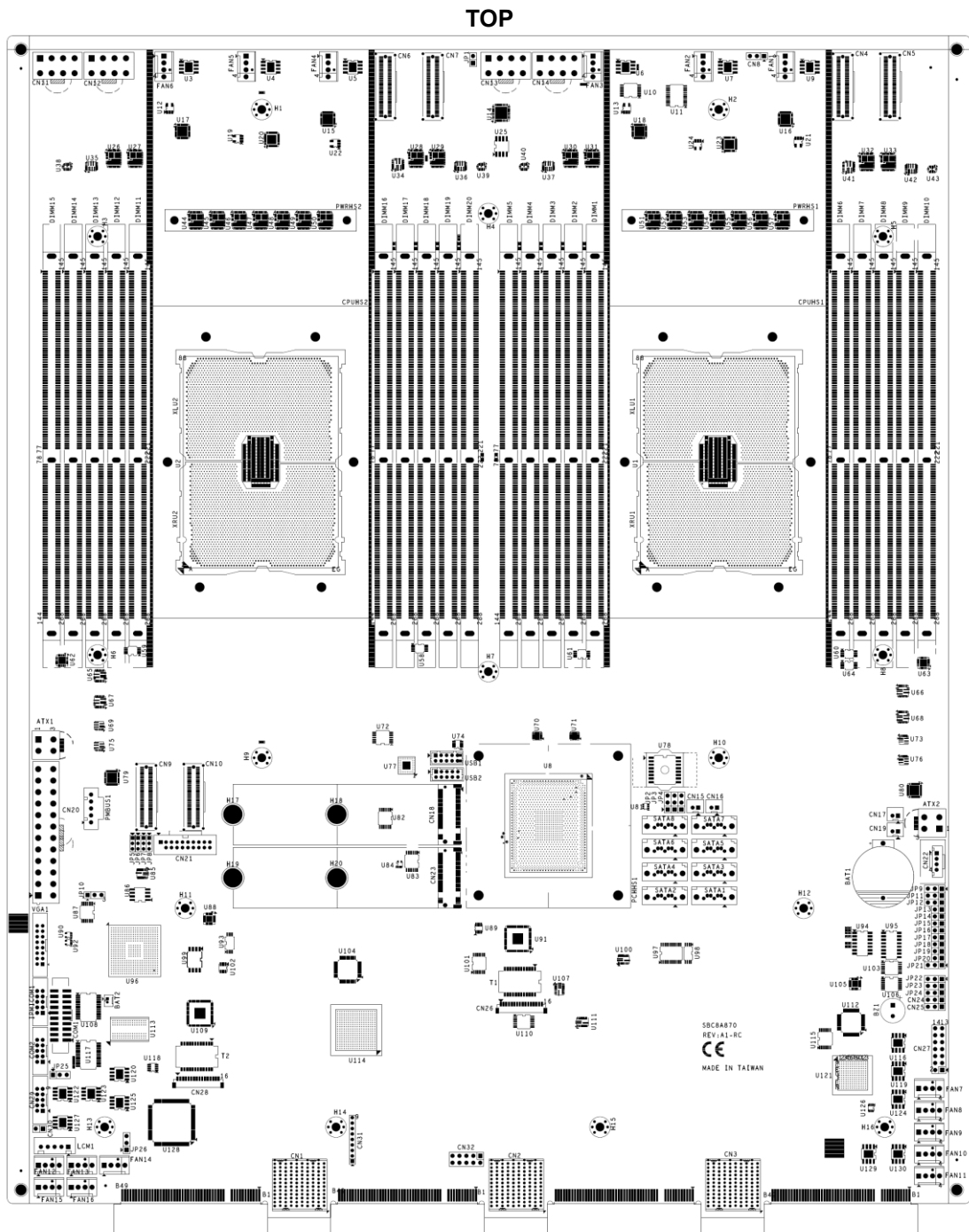



BOTTOM

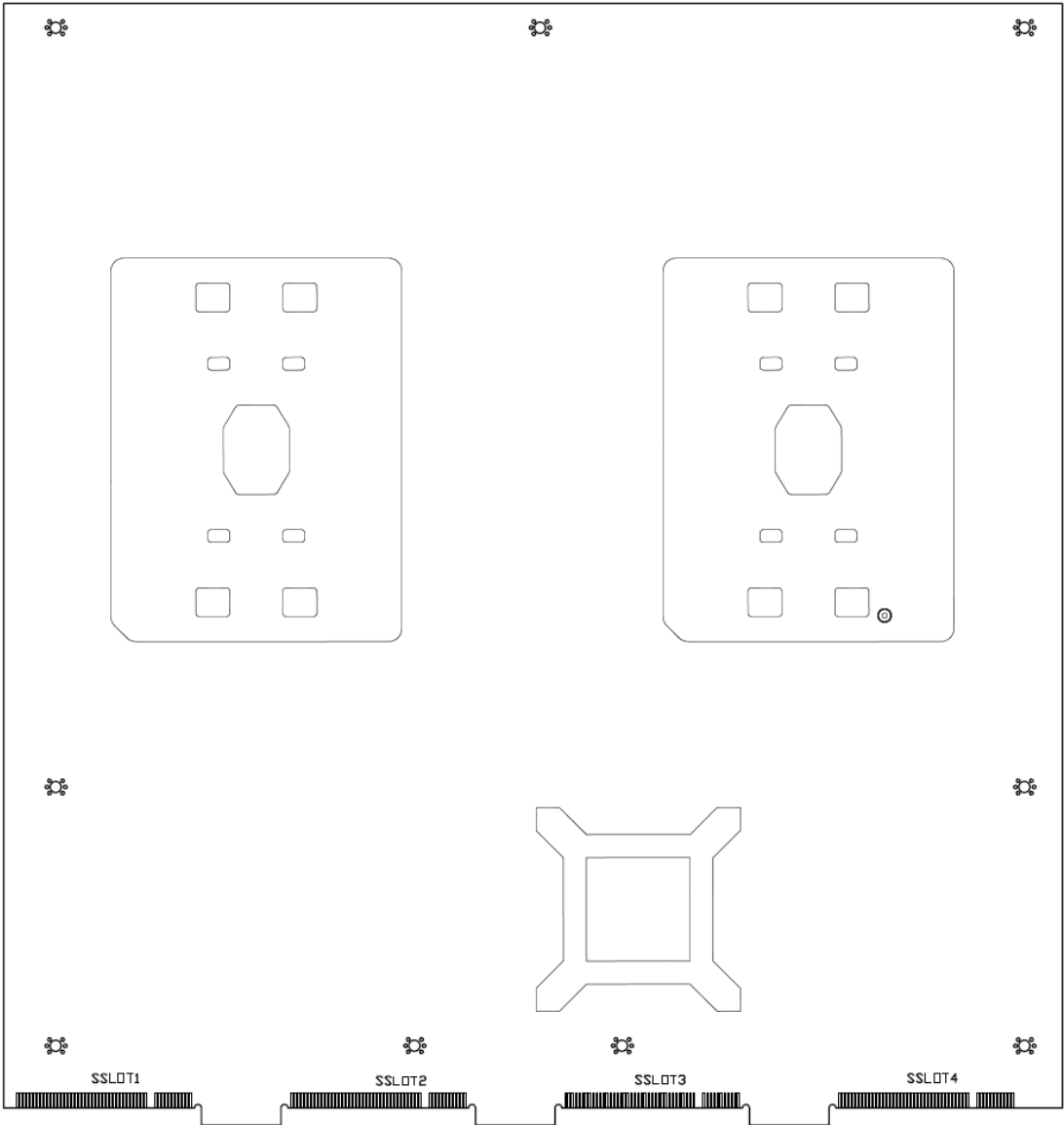

Block Diagram for SBC8A870

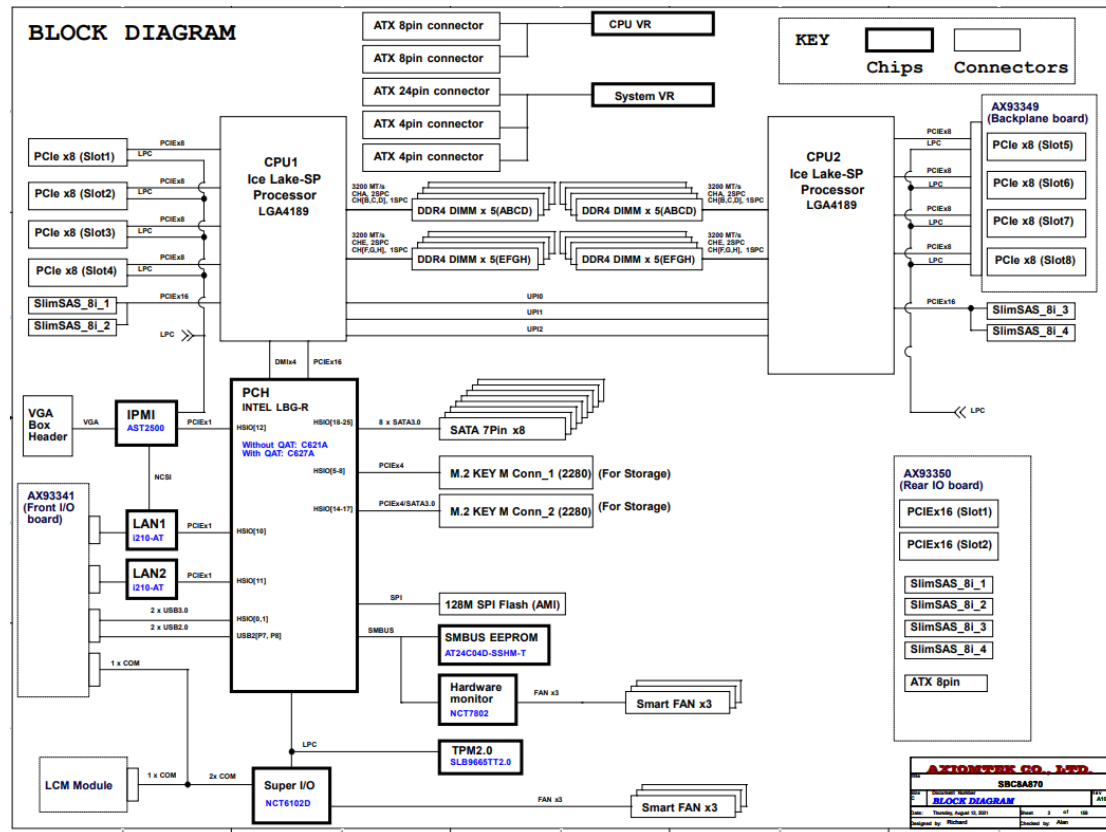

## 2.3 Jumper Settings for SBC8A870

Jumper is a small component consists of jumper clip and jumper pins. Install jumper clip on 2 jumper pins to close. And remove jumper clip from 2 jumper pins to open. Below illustration shows how to set up jumper.

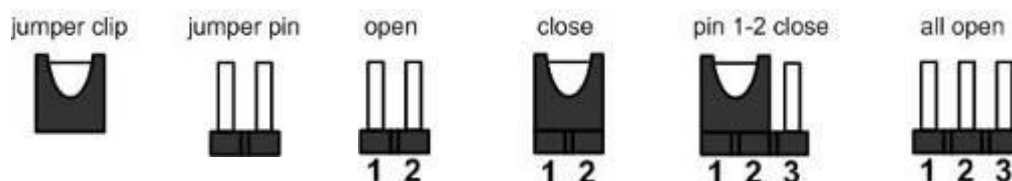

This section provides the information about jumpers and connectors of NA570 Series. Properly configure jumper settings on the main board in this appliance to meet your application purpose. Below we list a summary table of all jumpers and default settings for onboard devices.

Jumper	Definition	Jumper Setting
JP3	Clear CMOS Setting	1-2 : Normal (Default) 2-3 : Clear CMOS

### 2.3.1 CMOS Clear Jumper (JP12)

Use this jumper to erase and restore CMOS memory and BIOS setting. Put jumper clip to pin 2-3 for a few seconds then move it back to pin 1-2. By doing this procedure CMOS data resets to its safe default settings.

Description	Function	Jumper Setting
COMS Clear	Normal (Default)	
	Clear CMOS	

### 2.3.2 BMC Config FAN Quantity Jumper (J5&J6&J7) for option

Description	Function	Jumper Setting
BMC Config FAN Quantity Jumper	Jumper setting 1	
	Jumper setting 0	

JP7	JP6	JP5	FAN number
0	0	0	1
1	1	1	2
0	1	0	3
0	1	1	4
1	0	0	5
1	0	1	6
1	1	0	7
0	0	1	8

Note: Our default setting is 5 Fans.

## 2.4 Jumper Settings for AX93341

Jumper is a small component consists of jumper clip and jumper pins. Install jumper clip on 2 jumper pins to close. And remove jumper clip from 2 jumper pins to open. Below illustration shows how to set up jumper.

Jumper	Definition	Jumper Setting
JP1	TACT Switch(Down) Selection	1-2 : Power button 3-4 : Reset(Default) 5-6 : GPIO

### 2.4.1 TACT Switch Selection (JP1)

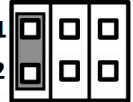
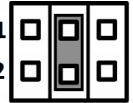
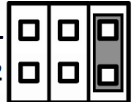
Description	Function	Jumper Setting
TACT Switch(Down) Selection	Power button	
	Reset(Default)	
	GPIO	

## 2.5 Connectors

Signals go to other parts of the system through connectors. Loose or improper connection might cause problems, please make sure all connectors are properly and firmly connected. Here is a summary table which shows all connectors on the hardware.

Connectors	Label
ATX 2*4 pin +12V CPU1 Power Connector	CN13
ATX 2*4 pin +12V CPU1 Power Connector	CN14
ATX 2*4 pin +12V CPU2 Power Connector	CN11
ATX 2*4 pin +12V CPU2 Power Connector	CN12
ATX 2*2 pin +12V Power Connector	ATX1
ATX 2*2 pin +12V Power Connector	ATX2
ATX 24 pin Power Connector	CN20
RTC coin battery Connector	BAT1
Serial Port2 Connector	COM2
M.2 M-key 2280 (PCIeX4 signal, SATA3 BOM option)	CN18
M.2 M-key 2280 (PCIeX4/SATA3 signal)	CN23
LCM Connector	LCM1
FIO Connector - USB3.0	CN21
FIO Connector – LAN1	CN26
FIO Connector – LAN2	CN28
FIO Connector – COM/LED/....	COM1
Front Panel Bezel Connector	CN27
DDR4 DIMM Socket (CPU1 Channel A DIMM0)	DIMM4
DDR4 DIMM Socket (CPU1 Channel A DIMM1)	DIMM3
DDR4 DIMM Socket (CPU1 Channel B DIMM0)	DIMM5
DDR4 DIMM Socket (CPU1 Channel C DIMM0)	DIMM1
DDR4 DIMM Socket (CPU1 Channel D DIMM0)	DIMM2
DDR4 DIMM Socket (CPU1 Channel E DIMM0)	DIMM9
DDR4 DIMM Socket (CPU1 Channel E DIMM1)	DIMM8
DDR4 DIMM Socket (CPU1 Channel F DIMM0)	DIMM10
DDR4 DIMM Socket (CPU1 Channel G DIMM0)	DIMM6
DDR4 DIMM Socket (CPU1 Channel H DIMM0)	DIMM7
DDR4 DIMM Socket (CPU2 Channel A DIMM0)	DIMM14
DDR4 DIMM Socket (CPU2 Channel A DIMM1)	DIMM13
DDR4 DIMM Socket (CPU2 Channel B DIMM0)	DIMM15

DDR4 DIMM Socket (CPU2 Channel C DIMM0)	DIMM11
DDR4 DIMM Socket (CPU2 Channel D DIMM0)	DIMM12
DDR4 DIMM Socket (CPU2 Channel E DIMM0)	DIMM19
DDR4 DIMM Socket (CPU2 Channel E DIMM1)	DIMM18
DDR4 DIMM Socket (CPU2 Channel F DIMM0)	DIMM20
DDR4 DIMM Socket (CPU2 Channel G DIMM0)	DIMM16
DDR4 DIMM Socket (CPU2 Channel H DIMM0)	DIMM17
System FAN	FAN1~6
PMBUS connector	PMBUS1
Serial ATA Connector	SATA1~8
USB2.0 Internal Connector (Reserved only)	USB1
USB2.0 Internal Connector (Reserved only)	USB2
VGA pin header	VGA1
Slim SAS connector (Connected to AX93350 CN1)	CN4
Slim SAS connector (Connected to AX93350 CN2)	CN5
Slim SAS connector (Connected to AX93350 CN3)	CN6
Slim SAS connector (Connected to AX93350 CN4)	CN7
CASE OPEN connector	CN30
DIO connector	CN29

### 2.5.1 ATX 2\*4 pin +12V CPU Power Connector (CN11, CN12, CN13, CN14)

+12V power supplied to CPU on the board by connecting the power connector. Please make sure all components and devices are properly installed before connecting the power connector.

Pin	Signal	Pin	Signal
1	Ground (GND)	2	Ground (GND)
3	Ground (GND)	4	Ground (GND)
5	+12V	6	+12V
7	+12V	8	+12V

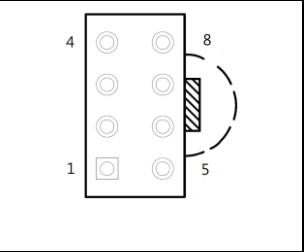

### 2.5.2 ATX 2\*2 PIN ATX + +12V Power Connector (ATX1, ATX2)

+12V power supplied to system on the board by connecting the power connector. Please make sure all components and devices are properly installed before connecting the power connector. We recommend connecting both ATX1 and ATX2 to board at the same time to adequately provide power.

### 2.5.3 Serial Port2 Connector (COM2)

Pin	Signal	Pin	Signal
1	Data Carrier Detect (DCD)	2	Data Set Ready (DSR)
3	Receive Date (RXD)	4	Request to Send (RTS)
5	Transmit Data (TXD)	6	Clear to Send (CTS)
7	Data Terminal Ready (DTR)	8	Ring Indicator (RI)
9	Ground (GND)	10	NC

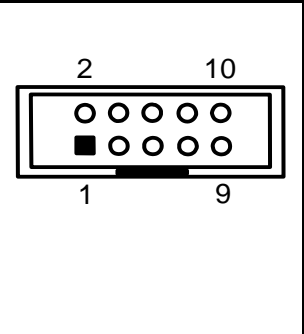

**2.5.4 M.2 M-key 2280 (CN23 ,CN18 default PCIe, SATA for option)**

Pin	Signal	Pin	Signal
1	Ground (GND)	2	+3.3V
3	Ground (GND)	4	+3.3V
5	PERN3	6	NC
7	PERP3	8	NC
9	Ground (GND)	10	LED1#
11	PETN3	12	+3.3V
13	PETP3	14	+3.3V
15	Ground (GND)	16	+3.3V
17	PERN2	18	+3.3V
19	PERP2	20	NC
21	Ground (GND)	22	NC
23	PETN2	24	NC
25	PETP2	26	NC
27	Ground (GND)	28	NC
29	PERN1	30	NC
31	PERP1	32	NC
33	Ground (GND)	34	NC
35	PETN1	36	NC
37	PETP1	38	DEVSL
39	Ground (GND)	40	SMB_CLK
41	PERN0/SATA-B+	42	SMB_DATA
43	PERP0/SATA-B-	44	ALERT#
45	Ground (GND)	46	NC
47	PETN0/ SATA-A-	48	NC
49	PETP0/ SATA-A+	50	PERST#
51	Ground (GND)	52	CLKREQ#
53	REFCLKN	54	PEWAKE#
55	REFCLKP	56	NC
57	Ground (GND)	58	NC
M Key			
67	NC	68	SUSCLK
69	PEDET	70	+3.3V
71	Ground (GND)	72	+3.3V
73	Ground (GND)	74	+3.3V
75	Ground (GND)		

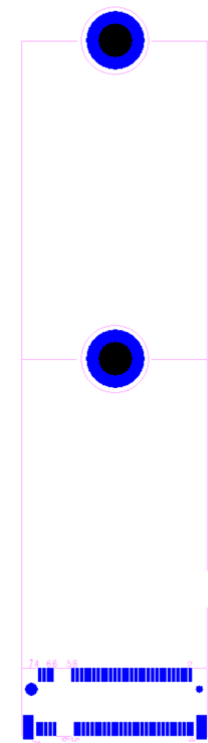



### 2.5.5 ATX24 pin Power Connector (CN20)

Steady and sufficient power can be supplied to all components on the board by connecting the power connector. Please make sure all components and devices are properly installed before connecting the power connector.

Pin	Signal	Pin	Signal
1	+3.3V	2	+3.3V
3	Ground (GND)	4	+5V
5	Ground (GND)	6	+5V
7	Ground (GND)	8	PWR_OK
9	5VSB	10	+12V
11	+12V	12	+3.3V
13	+3.3V	14	-12V
15	Ground (GND)	16	PS_ON
17	Ground (GND)	18	Ground (GND)
19	Ground (GND)	20	-5V
21	+5V	22	+5V
23	+5V	24	Ground (GND)

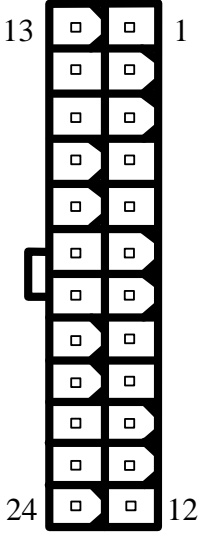

### 2.5.6 LCM Connector (LCM1)

This is a 5-pin connector for LCM.

Pin	Signal
1	+5V
2	RX Co-lay COM2)
3	NC
4	TX (Co-lay COM2)
5	Ground (GND)

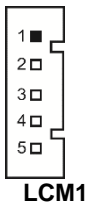

### 2.5.7 FIO Connector – USB3.0(CN21)

Pin	Signal	Pin	Signal
1	VBUS0	11	D1+
2	SSRX0-	12	D1-
3	SSRX0+	13	Ground (GND)
4	Ground (GND)	14	SSTX1+
5	SSTX0-	15	SSTX1-
6	SSTX0+	16	Ground (GND)
7	Ground (GND)	17	SSRX1+
8	D0-	18	SSRX1-
9	D0+	19	VBUS1
10	ID		

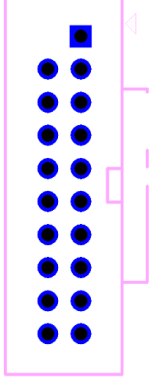

### 2.5.8 FIO Connector – LAN1, LAN2 (CN26, CN28)

Pin	Signal	Pin	Signal
1	LINK_1000#	9	MDI1+
2	LINK_100#	10	MDI0-
3	Ground (GND)	11	MDI0+
4	MDI3-	12	Ground (GND)
5	MDI3+	13	P3V3_AUX
6	MDI2-	14	LINK/ACT#
7	MDI2+	15	P3V3
8	MDI1-	16	Ground (GND)



### 2.5.9 Front Panel Bezel Connector (CN27)

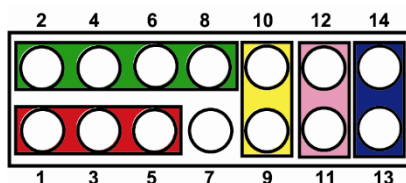

#### Power LED :

This 3-pin connector (Pin 1, 3, 5) connects a LED indicator to the system power switch on the case. Pin 1 is assigned as +, and Pin 3, Pin 5 as -. The Power LED lights up when the system is powered ON.

#### External Speaker and Internal Buzzer Connector :

This 4-pin connector (Pin 2, 4, 6, 8) can be connected to the case-mounted speaker unit or internal buzzer. While connecting the CPU card to an internal buzzer, please short pins 2-4; while connecting to an external speaker, you need to set pins 2-4 to Open and connect the speaker cable to pin 8 (+) and pin 2 (-).

#### ATX Power On/Off Button :

This 2-pin connector (Pin 9, 10) connects the front panel's ATX power button to the CPU card, which allows users to control ATX power supply to be power on/off.

#### System Reset Switch :

This 2-pin connector (Pin 11, 12) can be connected to the case-mounted reset switch that reboots your computer instead of turning OFF the power switch. It is a better way to reboot your system for a longer life of the system's power supply.

#### HDD Activity LED :

This connection is linked to hard drive activity LED on the control panel. LED flashes when HDD is being accessed. The 2-pin connector (Pin 13, 14) connects the hard disk drive to the front panel HDD LED, Pin 13 assigned as -, and Pin 14 as +.

### 2.5.10 Digital input/output Connector (CN29)

Pin	Signal	Pin	Signal
1	Ground (GND)	2	Ground (GND)
3	GPO3	4	GPI3
5	GPO2	6	GPI2
7	GPO1	8	GPI1
9	GPO0	10	GPI0

### 2.5.11 FAN Connectors (FAN1~FAN6)

System fans are always needed to cool down CPU and system temperature. FAN1~FAN6 connectors provide power to these system fan.

Pin	Signal
1	Ground (GND)
2	+12V
3	Rotation Detection In
4	PWM signal



### 2.5.12 PMBUS connector (PMBUS1)

Pin	Signal
1	SMBCLK
2	SMBDAT
3	SMB_ALERT_N
4	Ground (GND)
5	NC

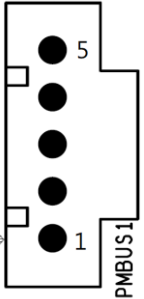

### 2.5.13 Serial ATA Connectors (SATA1-8)

These Serial Advanced Technology Attachment (SATA) connectors are for high-speed SATA interface ports. They are computer bus interfaces for connecting to devices such as serial ATA hard disk drives. Each SATA connector supports a single SATA device.

Pin	Signal	Pin	Signal
1	Ground (GND)	2	TX+
3	TX-	4	Ground (GND)
5	RX-	6	RX+
7	Ground (GND)		



### 2.5.14 USB2.0 Port Connector (USB1, USB2)

The 10-pin standard Universal Serial Bus 2.0(USB2.0) connector on this board is for installing versatile USB interface peripherals.

Pin	Signal	Pin	Signal
1	USB_POWER	2	USB_POWER
3	USB_P1_DN	4	USB_P2_DN
5	USB_P1_DP	6	USB_P2_DP
7	Ground (GND)	8	Ground (GND)
9	Ground (GND)	10	Ground (GND)

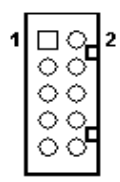

### 2.5.15 VGA pin header (VGA1)

Pin	Signal	Pin	Signal
1	RED	2	NC
3	GREEN	4	NC
5	BLUE	6	Ground (GND)
7	VCC (+5V Level)	8	DDC DATA
9	Ground (GND)	10	Ground (GND)
11	Ground (GND)	12	Horizontal Sync
13	Ground (GND)	14	Vertical Sync
15	DDC CLK	16	NC

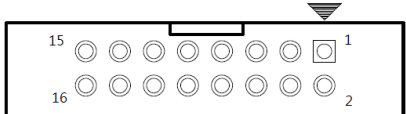

### 2.5.16 FIO Connector – COM/LED (COM1)

Pin	Signal	Pin	Signal
1	MDCD1	2	GPIO_LED1#
3	MRXD1	4	GPIO_LED2#
5	MTXD1	6	FM_SLPS3_N
7	MDTR1	8	P3V3
9	P5V_AUX	10	Ground (GND)
11	NDSR1	12	FP_HDD_LED_N
13	NRTS1	14	FP_PSIN_N
15	NCTS1	16	IOB_RST_N
17	MRI1	18	SL9_GPI_SW1_N
19	Ground (GND)	20	Ground (GND)

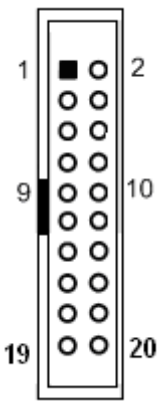

### 2.5.17 Serial Port1(For Console) Connector (COM1)

The COM1 Port connector is a RJ-type connector.

Pin	Signal	
1	Data Set Ready (DSR)	
2	Request to Send (RTS)	
3	Ground (GND)	
4	Transmit Data (TXD)	
5	Receive Data (RXD)	
6	Data Carrier Detect (DCD)	
7	Clear to Send (CTS)	
8	Data Terminal Ready (DTR)	

### 2.5.18 Case open Connector (CN30)

Pin	Signal	
1	CASEOPEN#	
2	GND	

## 2.6 Hardware Installation

This section provides information of how to install the NA870Series.

### 2.6.1 Install the CPU

Before installing the processor, please access Intel® website for more detailed information of the Processor Installation Manual (LGA4189):

[https://www.intel.com/content/dam/support/us/en/documents/processors/xeon/LGA4189\\_Boxed\\_Xeon.pdf](https://www.intel.com/content/dam/support/us/en/documents/processors/xeon/LGA4189_Boxed_Xeon.pdf).

The LGA4189 processor socket comes with a cover to protect the processor. Please install the processor into the CPU socket step by step as below:

Before installing the CPU, please loosen the 4 screws of the air ducts first.

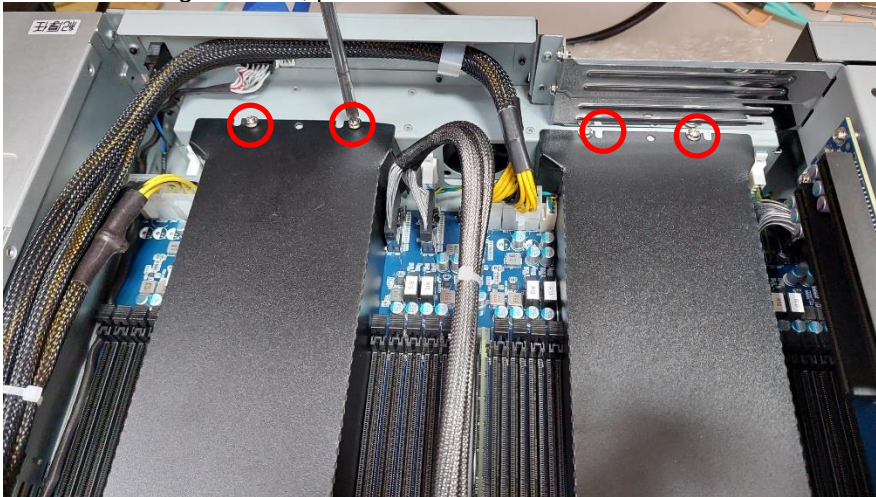

Remove the socket protective covers

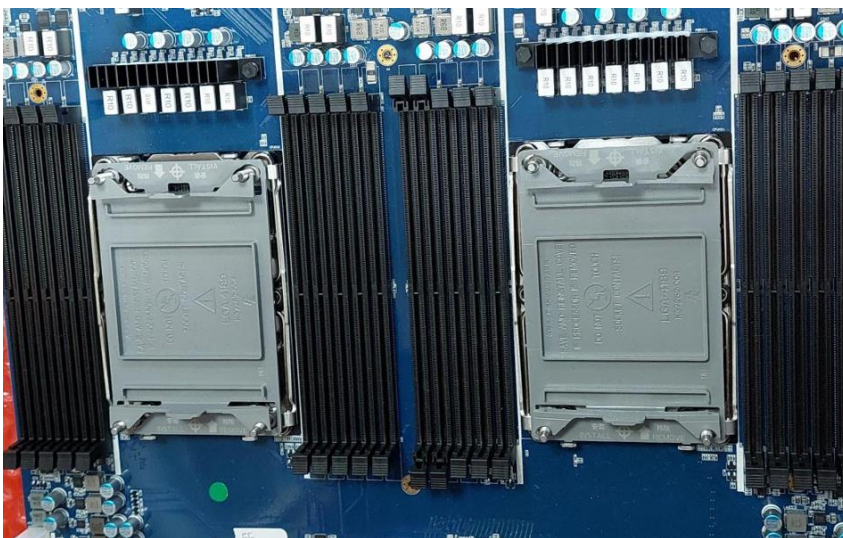

Insert the CPU onto the CPU clip and align notch A to D on the CPU clip, then latch pin 1 to 4

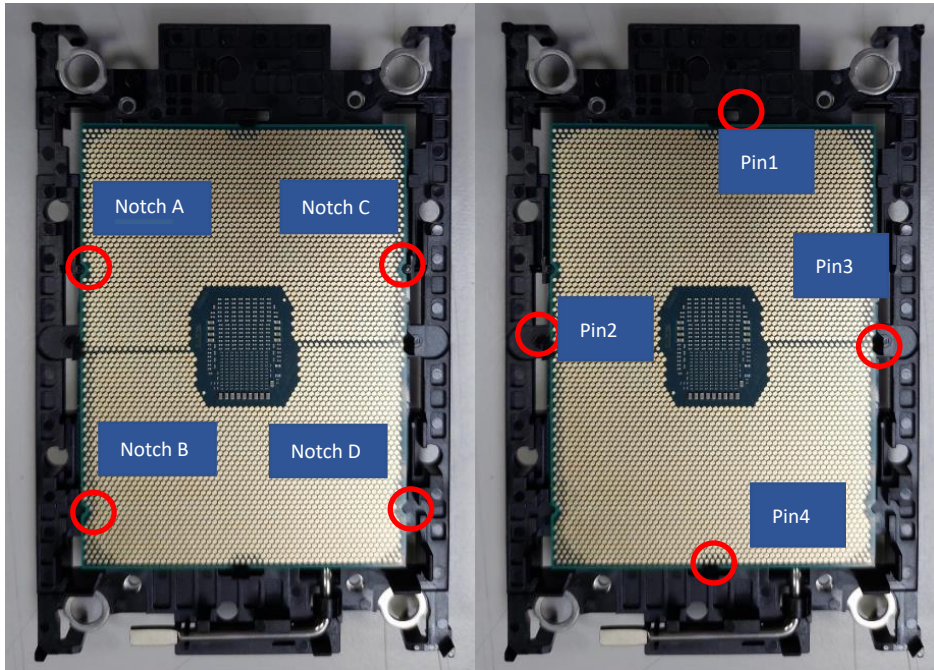

Lower the processor heatsink module to the locket. Align the pin 1 corner to the bolster plate pin 1 corner.

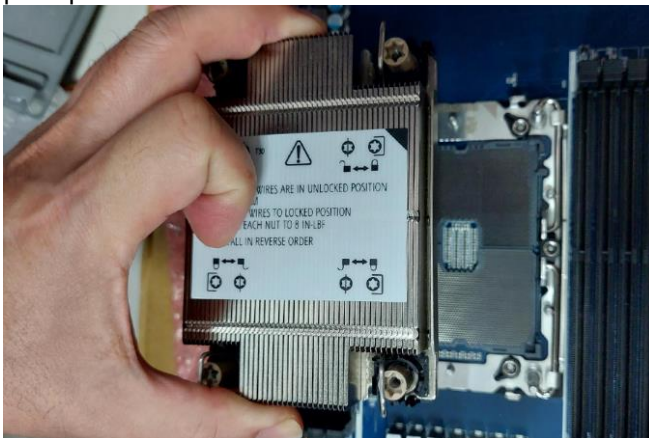



Push for anti-tilt wire lever outward to locked position. Confirm the anti-tilt wires engage anti-tilt flanges on the bolster plate.

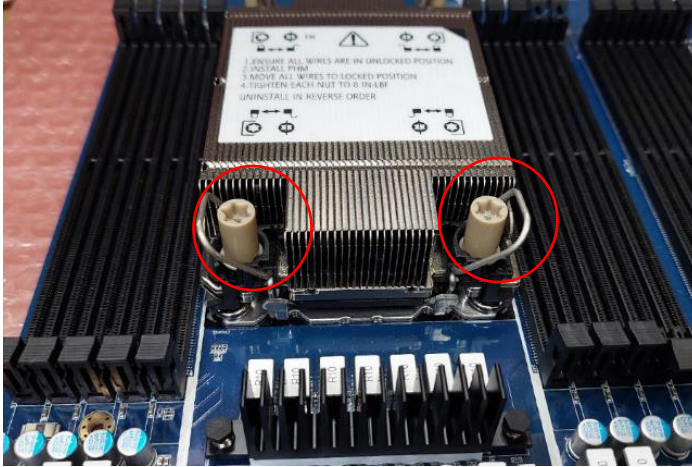

Use the T-30 Torx driver tighten the heatsink nuts.



After installing the CPU, please lock the screws of air ducts.

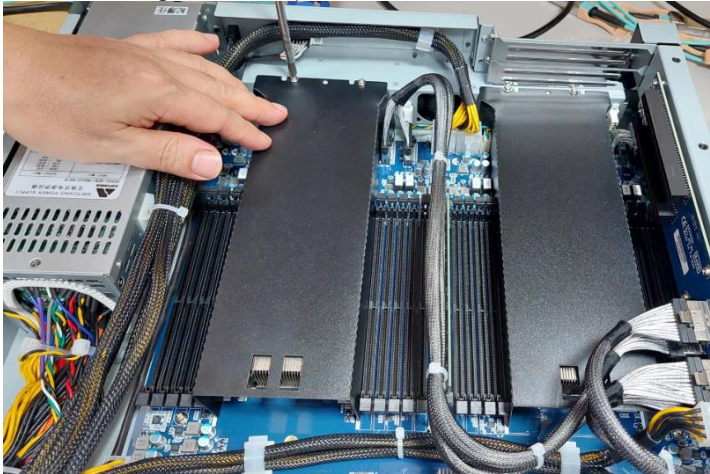

**Note:** To protect the CPU socket pins, do not remove the CPU cap when the CPU is not installed.

## 2.6.2 Install the Memory

The board supports twenty 288-pin DDR4 RDIMM memory sockets with maximum memory capacity up to 1280GB.

Please follow steps below to install the memory modules:

1. Push down latches on each side of the DIMM socket.
2. Align the memory module with the socket that notches of memory module must match the socket keys for a correct installation.
3. Install the memory module into the socket and push it firmly down until it is fully seated. The socket latches are levered upwards and clipped on to the edges of the DIMM.
4. Install any remaining DIMM modules.

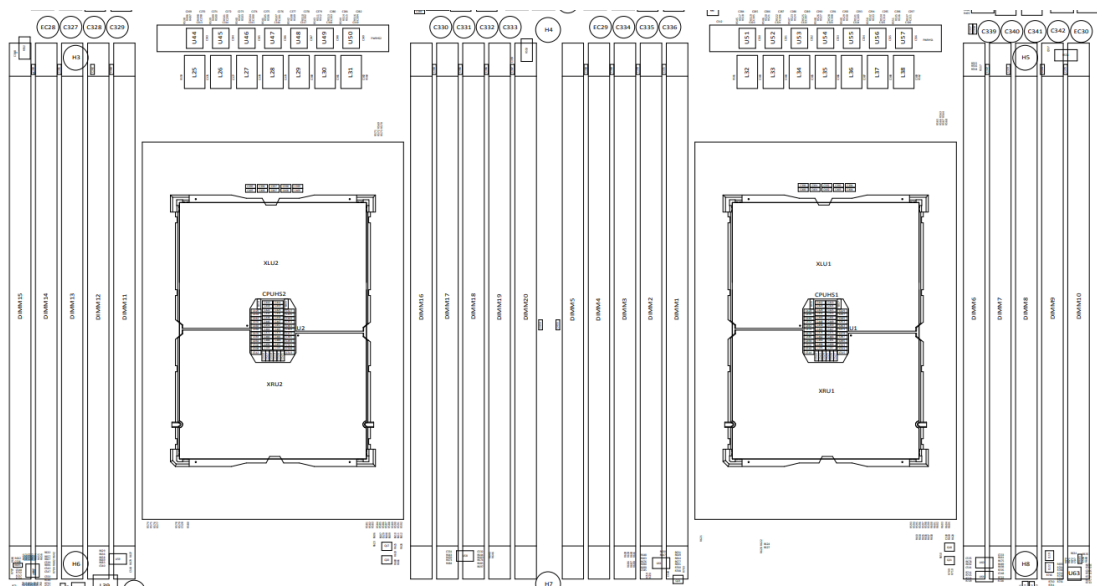
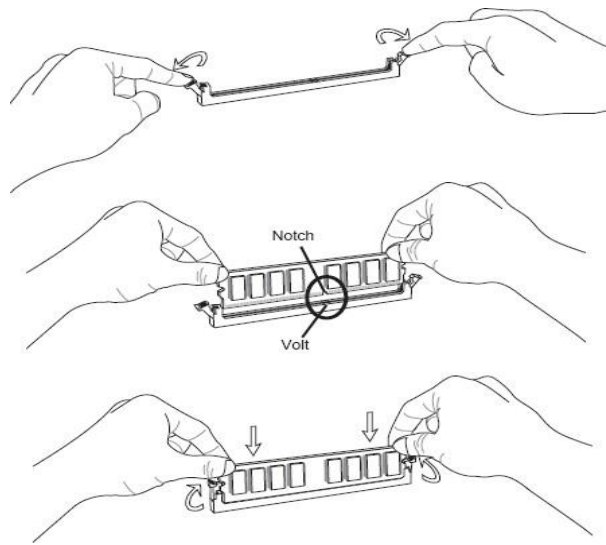

**DIMM Configuration with single CPU**

	Quantity of memory installed									
CPU1	1	2	3	4	5	6	7	8	9	10
DIMM1				•				•		•
DIMM2								•		•
DIMM3										•
DIMM4	•	•		•				•		•
DIMM5								•		•
DIMM6				•				•		•
DIMM7								•		•
DIMM8										•
DIMM9		•		•				•		•
DIMM10								•		•

Note: 3,5,6,7,9 DIMMs are not recommended DIMM population when single CPU were installed

**DIMM Configuration with dual CPU**

	Quantity of memory installed																			
CPU1&CPU2	1	2	3	4	5	6	7	8	9	10	11	12	13	14	15	16	17	18	19	20
<b>CPU1</b>																				
DIMM1								•								•				•
DIMM2																•				•
DIMM3																				•
DIMM4	•		•					•								•				•
DIMM5																•				•
DIMM6								•								•				•
DIMM7																•				•
DIMM8																				•
DIMM9			•					•								•				•
DIMM10																•				•
<b>CPU2</b>																				
DIMM11								•								•				•
DIMM12																•				•
DIMM13																				•
DIMM14	•		•					•								•				•
DIMM15																•				•
DIMM16								•								•				•
DIMM17																•				•
DIMM18																				•



**This page is intentionally left blank.**

# Section 3

## AMI BIOS Setup Utility

The AMI BIOS provides users with a built-in setup program to modify basic system configuration. All configured parameters are stored in a battery-backed-up RAM (CMOS RAM) to save the setup information whenever the power is turned off. This chapter provides users with detailed description about how to set up basic system configuration through the AMI BIOS setup utility.

### 3.1 Starting

To enter the setup screens, follow the steps below:

Turn on the computer and press the <DEL> or <ESC> key immediately. After you press the <DEL> or <ESC> key, the main BIOS setup menu displays. You can access the other setup screens from the main BIOS setup menu, such as the Advanced and Chipset menus.

It is strongly recommended that you should avoid changing the chipset's defaults. Both AMI and your system manufacturer have carefully set up these defaults that provide the best performance and reliability.

### 3.2 Navigation Keys

The BIOS setup/utility uses a key-based navigation system called hot keys. Most of the BIOS setup utility hot keys can be used at any time during the setup navigation process. These keys include <F1>, <F2>, <Enter>, <ESC>, <Arrow> keys, and so on.



**Note:** *Some of the navigation keys differ from one screen to another.*

Hot Keys	Description
→← Left/Right	The Left and Right <Arrow> keys allow you to select a setup screen.
↑↓ Up/Down	The Up and Down <Arrow> keys allow you to select a setup screen or sub-screen.
+– Plus/Minus	The Plus and Minus <Arrow> keys allow you to change the field value of a particular setup item.
Tab	The <Tab> key allows you to select setup fields.
F1	The <F1> key allows you to display the general help screen.
F2	The <F2> key allows you to load previous values.
F3	The <F3> key allows you to load optimized defaults.
F4	The <F4> key allows you to save any changes you have made and exit setup. Press the <F4> key to save your changes.
Esc	The <Esc> key allows you to discard any changes you have made and exit the setup. Press the <Esc> key to exit the setup without saving your changes.
Enter	The <Enter> key allows you to display or change the setup option listed for a particular setup item. The <Enter> key can also allow you to display the setup sub- screens.



### 3.3 Main Menu

When you first enter the setup utility, you will enter the Main setup screen. You can always return to the Main setup screen by selecting the Main tab. System Time/Date can be set up as described below. The Main BIOS setup screen is shown below.

```

Aptio Setup - AMI
Main  Advanced  Platform Configuration  Socket Configuration  Security
-----
| BIOS Information                                     |Set the Date. Use Tab
| BIOS Vendor           American Megatrends          |to switch between Date
| Core Version          5.21                          |elements.
| Compliancy            UEFI 2.8; PI 1.7              |Default Ranges:
| Project Version       8A870 X006                    |Year: 1998-9999
| Build Date and Time   07/29/2021 16:00:46          |Months: 1-12
| Access Level          Administrator                 |Days: Dependent on month
|                                     |Range of Years may vary.
| Platform Information
| Processor             606A6 - ICX D0
| PCH                  LBG QS/PRQ - C621A -...
| RC Revision          20.P35
|                                     |<<: Select Screen
| Memory Information
| Total Memory         8192 MB
|                                     |^v: Select Item
| System Date          [Mon 01/10/2022]
| System Time          [05:58:43]
|                                     |Enter: Select
|                                     |+/-: Change Opt.
|                                     |F1: General Help
|                                     |F2: Previous Values
|                                     |F3: Optimized Defaults
|                                     |F4: Save & Exit
|                                     |ESC: Exit

```

#### System Date/Time

Use this option to change the system time and date. Highlight System Time or System Date using the <Arrow> keys. Enter new values through the keyboard. Press the <Tab> key or the <Arrow> keys to move between fields. The date must be entered in MM/DD/YY format. The time is entered in HH:MM:SS format.

### 3.4 Advanced Menu

The Advanced menu also allows users to set configuration of the CPU and other system devices. You can select any of the items in the left frame of the screen to go to the sub menus:

- ▶ Trusted Computing
- ▶ AST2500SEC Super IO Configuration
- ▶ NCT6102D Super IO Configuration
- ▶ HW Monitor
- ▶ Serial Port Console Redirection
- ▶ CSM Configuration
- ▶ USB Configuration

For items marked with “▶”, please press <Enter> for more options.

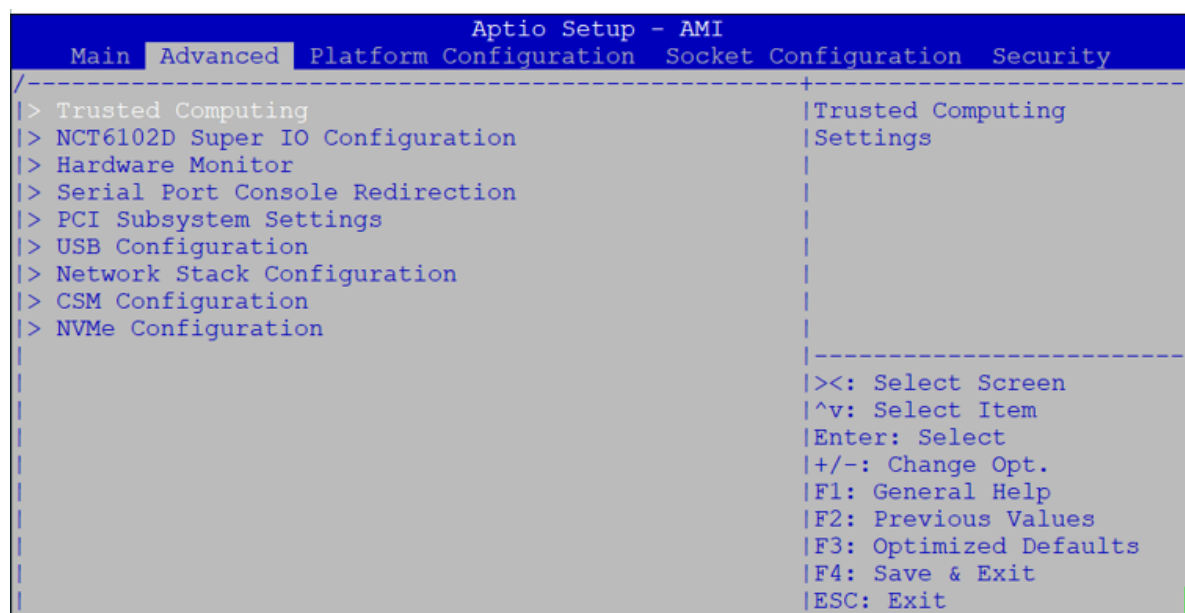

#### Trusted Computing

This screen provides a menu for specifying the TPM settings.

**Security Device Support**

This item allows you to select the security device support. Configuration options: Enabled or Disabled.

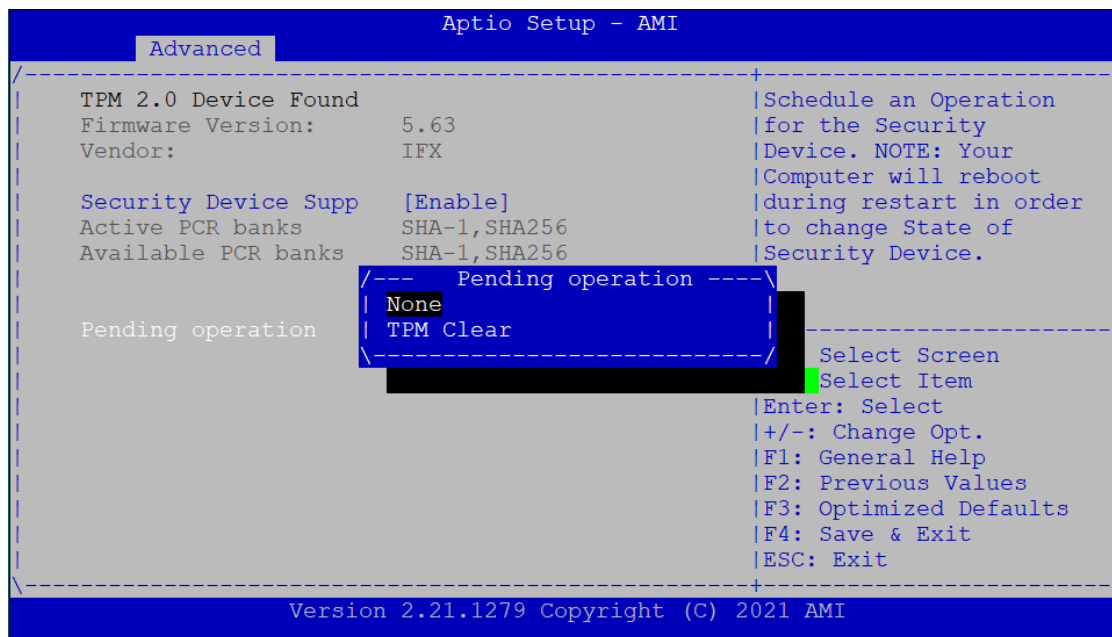
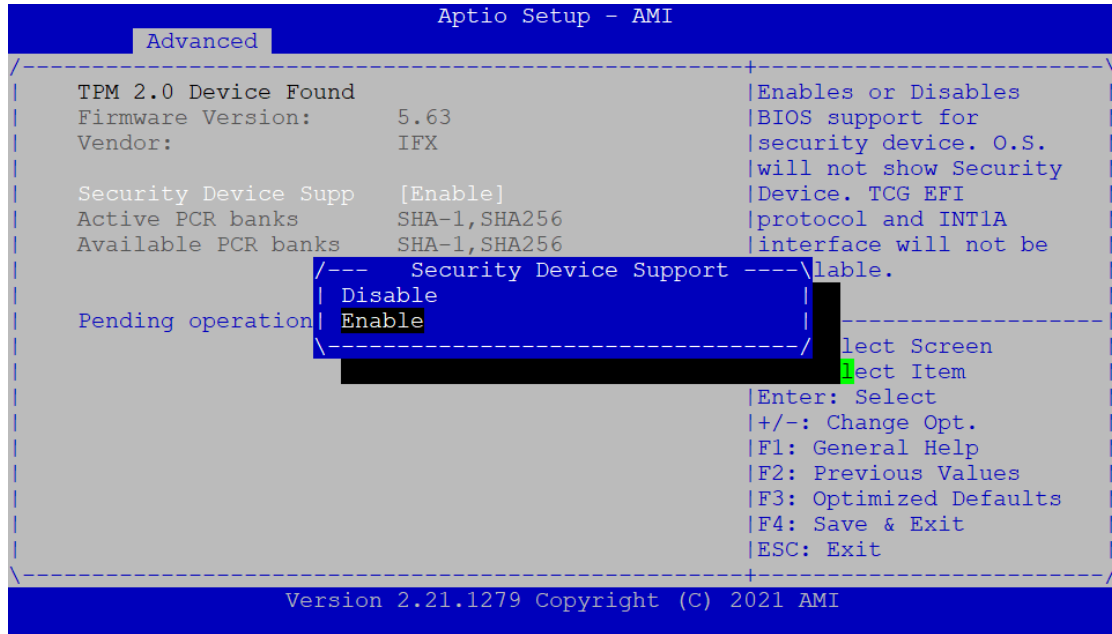

### AST2500SEC Super IO Configuration

You can select options for the Super IO Configuration and change the value of the selected option. Descriptions of the selected item appears on the right side of the screen.



### Serial Port 1 Configuration

This option specifies the base I/O port address and Interrupt Request address of serial port 1. The Optimal setting is 240h/IRQ4.

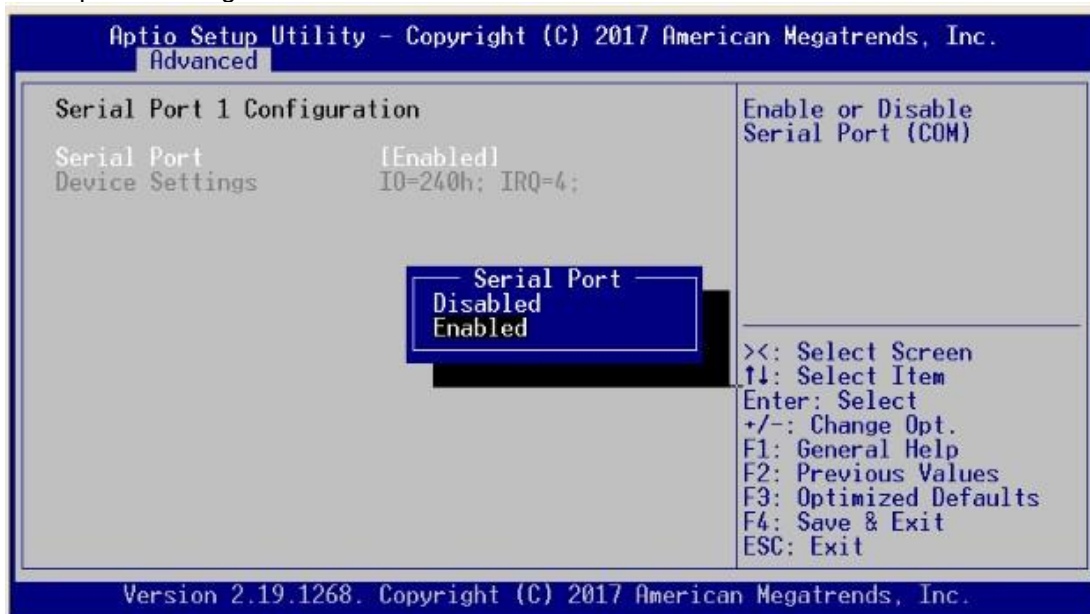

### Serial Port 2 Configuration

This option specifies the base I/O port address and Interrupt Request address of serial port 2. The Optimal setting is 248h/IRQ10

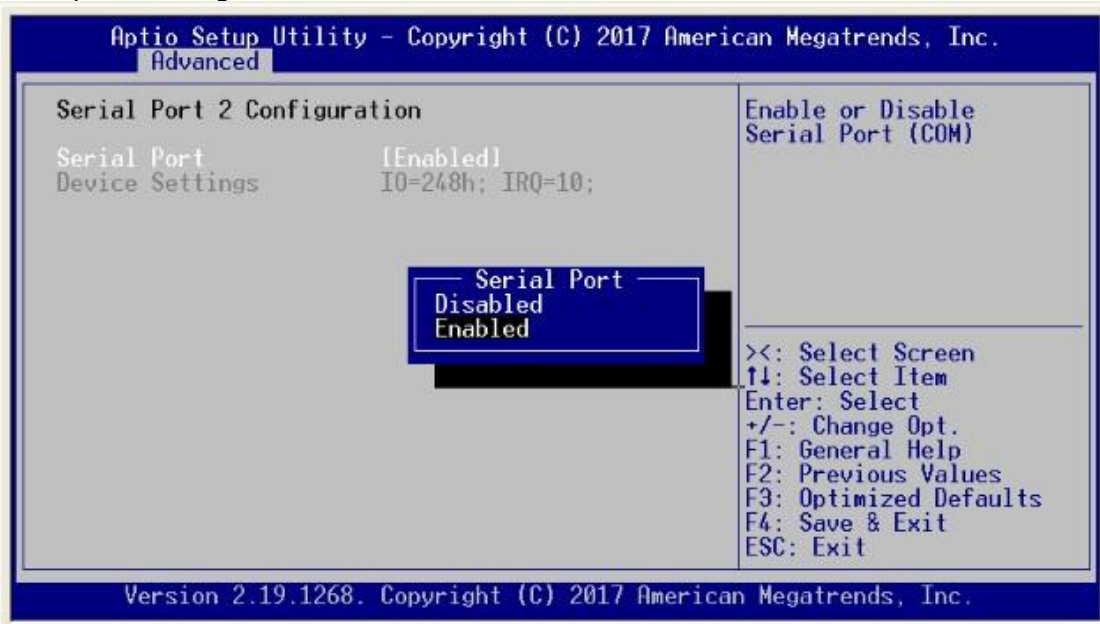

### NCT6102 Super IO Configuration

This screen to select options for the Super IO Configuration

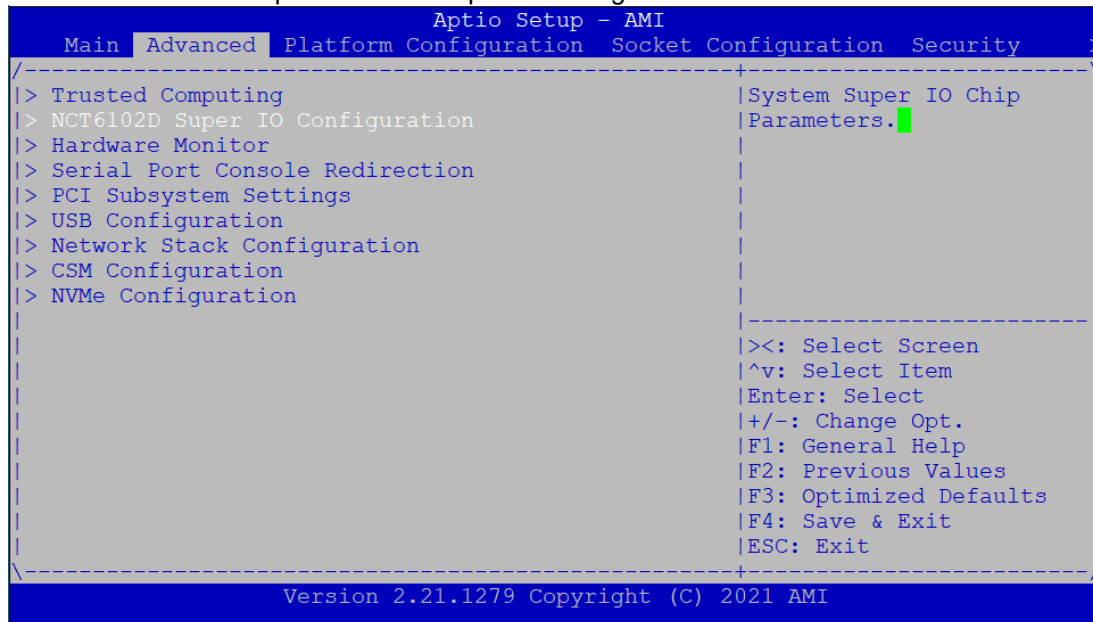

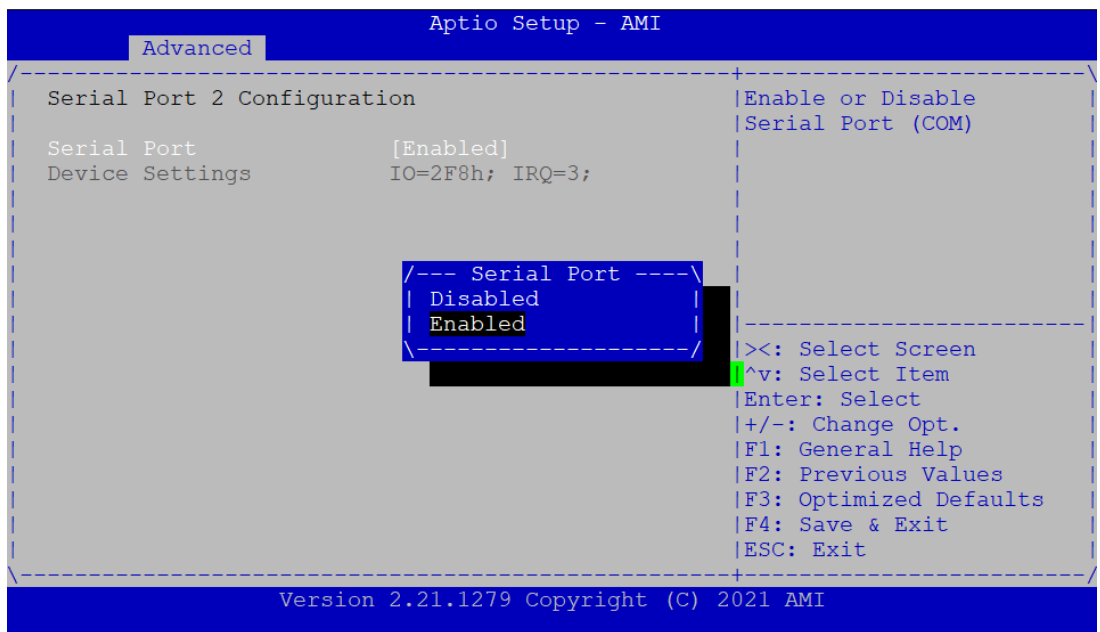
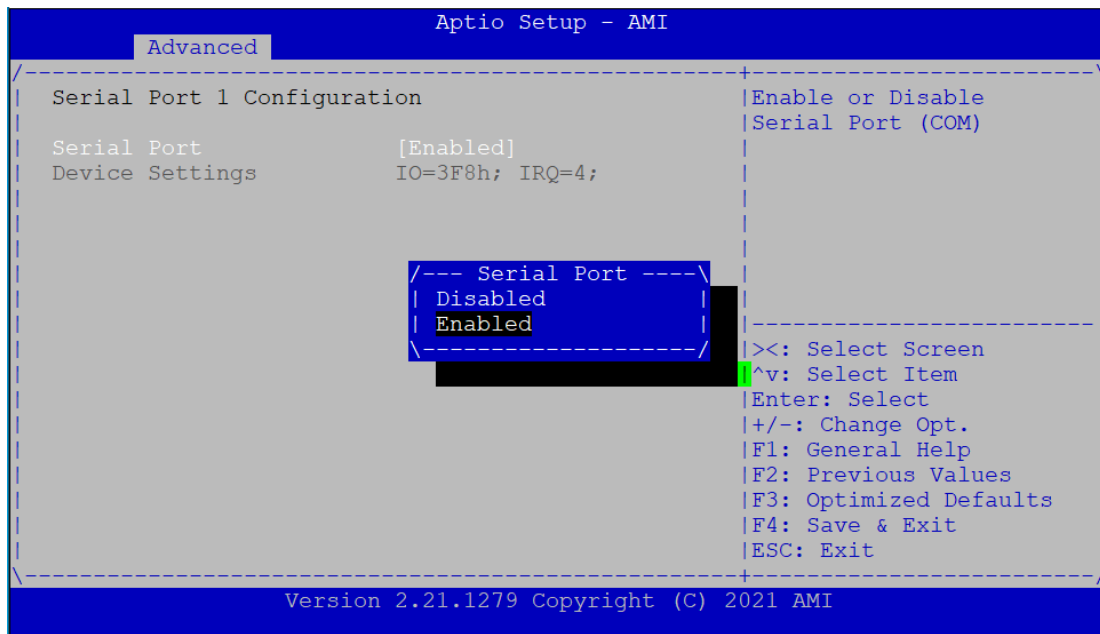

```

Aptio Setup - AMI
  Advanced
-----+-----
| NCT6102D Super IO Configuration          |Select whether to ^|
|                                          |enable Chassis   *|
| Super IO Chip          NCT6102D        |Intrusion Detection.*|
|> Serial Port 1 Configuration          |Chassis Intrusion *|
|> Serial Port 2 Configuration          |Detection is a utility *|
|                                          |that can tell whether +|
| Chassis Opened Warning [Disabled]      |someone has opened the +|
|                                          |se (intruded into the v|
| /---- Chassis Opened Warning ----\   |
| | Disabled                          |
| | Enabled                            |
| \-----/                             |
|                                          |Select Screen
|                                          |Select Item
|                                          |Enter: Select
|                                          |+/-: Change Opt.
|                                          |F1: General Help
|                                          |F2: Previous Values
|                                          |F3: Optimized Defaults
|                                          |F4: Save & Exit
|                                          |ESC: Exit
-----+-----
Version 2.21.1279 Copyright (C) 2021 AMI
  
```

## HW Monitor

This screen monitors the health status of the hardware

```

Aptio Setup - AMI
Main  Advanced  Platform Configuration  Socket Configuration  Security  >
-----
|> Trusted Computing                |Go to Hardware Monitor
|> NCT6102D Super IO Configuration  |Page
|> Hardware Monitor                 |
|> Serial Port Console Redirection  |
|> PCI Subsystem Settings           |
|> USB Configuration                |
|> Network Stack Configuration      |
|> CSM Configuration                |
|> NVMe Configuration               |
|                                   |
|                                   |><: Select Screen
|                                   |^v: Select Item
|                                   |Enter: Select
|                                   |+/-: Change Opt.
|                                   |F1: General Help
|                                   |F2: Previous Values
|                                   |F3: Optimized Defaults
|                                   |F4: Save & Exit
|                                   |ESC: Exit
|                                   |
-----
Version 2.21.1279 Copyright (C) 2021 AMI
  
```

```

Aptio Setup - AMI
Advanced
-----
| Hardware Monitor                  |NCT7802Y Hardware
|> NCT7802Y Hardware Monitor        |Monitor Page
|> NCT6102D Hardware Monitor        |
|                                   |
|                                   |><: Select Screen
|                                   |^v: Select Item
|                                   |Enter: Select
|                                   |+/-: Change Opt.
|                                   |F1: General Help
|                                   |F2: Previous Values
|                                   |F3: Optimized Defaults
|                                   |F4: Save & Exit
|                                   |ESC: Exit
|                                   |
-----
Version 2.21.1279 Copyright (C) 2021 AMI
  
```



**This screen displays the fan speed in RPM**

```

Aptio Setup - AMI
  Advanced
-----
Pc Health Status

CPU1 Temperature      : +50 C
FAN1 Speed            : 15168 RPM
FAN2 Speed            : 15882 RPM
FAN3 Speed            : 15340 RPM

|><: Select Screen
|^v: Select Item
|Enter: Select
|+/-: Change Opt.
|F1: General Help
|F2: Previous Values
|F3: Optimized Defaults
|F4: Save & Exit
|ESC: Exit
-----
Version 2.21.1279 Copyright (C) 2021 AMI
  
```

```

Aptio Setup - AMI
  Advanced
-----
Hardware Monitor
|> NCT7802Y Hardware Monitor
|> NCT6102D Hardware Monitor

|NCT6102D Hardware
|Monitor Page

|><: Select Screen
|^v: Select Item
|Enter: Select
|+/-: Change Opt.
|F1: General Help
|F2: Previous Values
|F3: Optimized Defaults
|F4: Save & Exit
|ESC: Exit
-----
Version 2.21.1279 Copyright (C) 2021 AMI
  
```

```

Aptio Setup - AMI
  Advanced
-----
Pc Health Status
System Temperature2      : +43
CPU2 Temperature        : +49
FAN4 Speed               : 15340 RPM
FAN5 Speed               : 16666 RPM
FAN6 Speed               : N/A
V CORE                   : +1.824 V
5VSB                     : +5.056 V
VBAT                     : +3.104 V
-----
|><: Select Screen
|^v: Select Item
|Enter: Select
|+/-: Change Opt.
|F1: General Help
|F2: Previous Values
|F3: Optimized Defaults
|F4: Save & Exit
|ESC: Exit
-----
Version 2.21.1279 Copyright (C) 2021 AMI
  
```

### Serial Port Console Redirection

```

Aptio Setup - AMI
  Main  Advanced  Platform Configuration  Socket Configuration  Security  >
-----
|> Trusted Computing
|> NCT6102D Super IO Configuration
|> Hardware Monitor
|> Serial Port Console Redirection
|> PCI Subsystem Settings
|> USB Configuration
|> Network Stack Configuration
|> CSM Configuration
|> NVMe Configuration
-----
|><: Select Screen
|^v: Select Item
|Enter: Select
|+/-: Change Opt.
|F1: General Help
|F2: Previous Values
|F3: Optimized Defaults
|F4: Save & Exit
|ESC: Exit
  
```

**Console Redirection**

Use this item to enable or disable console redirection. The settings specify how the host computer and remote computer (which the user is using) will exchange data. Both computers should have the same or compatible setting.

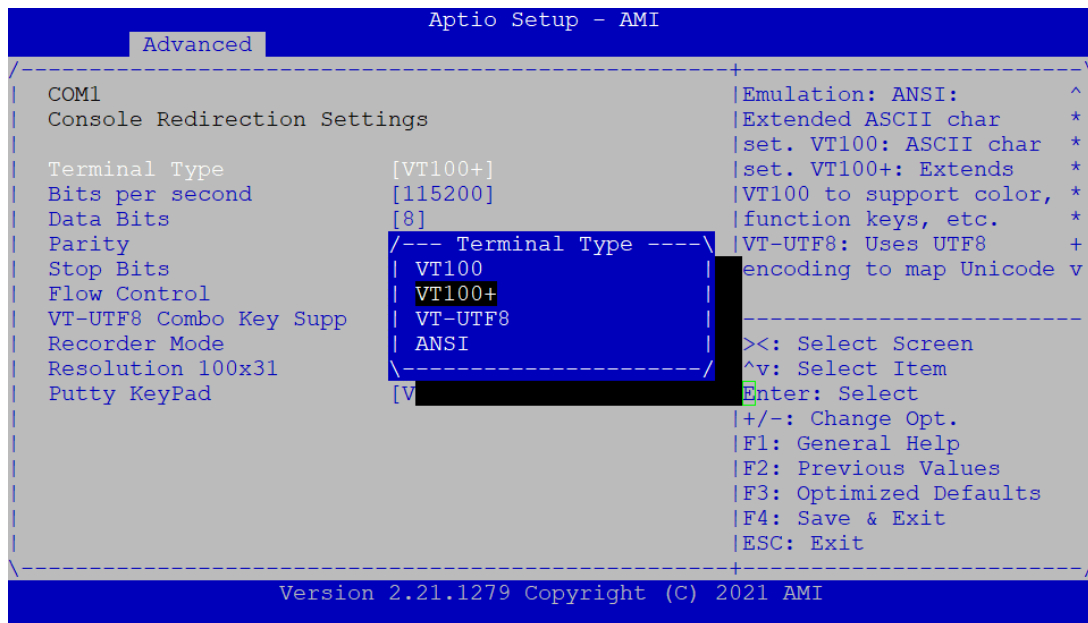
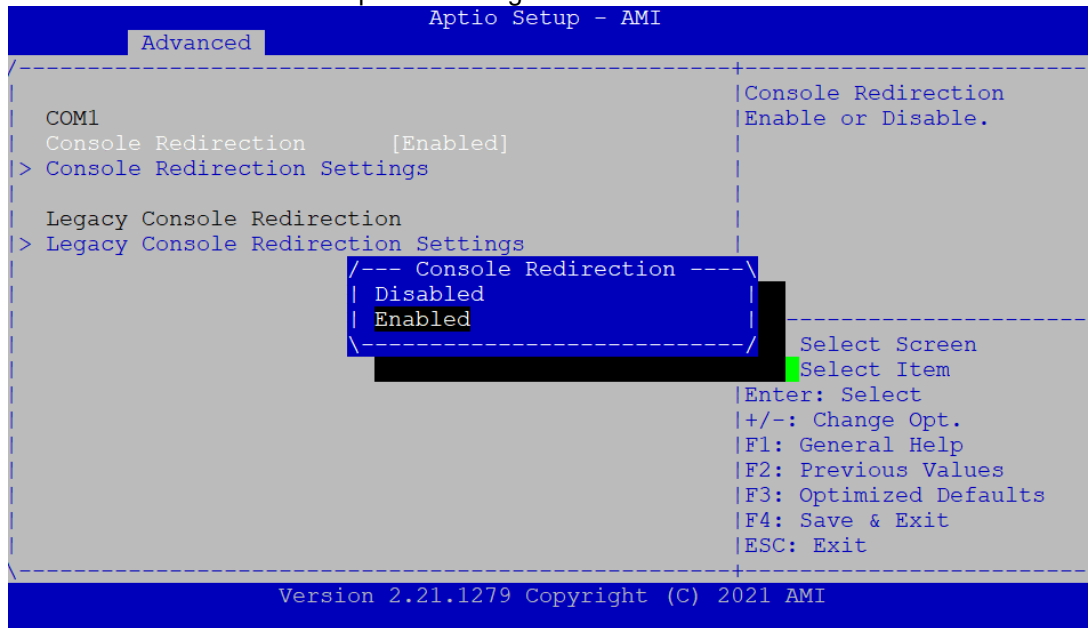

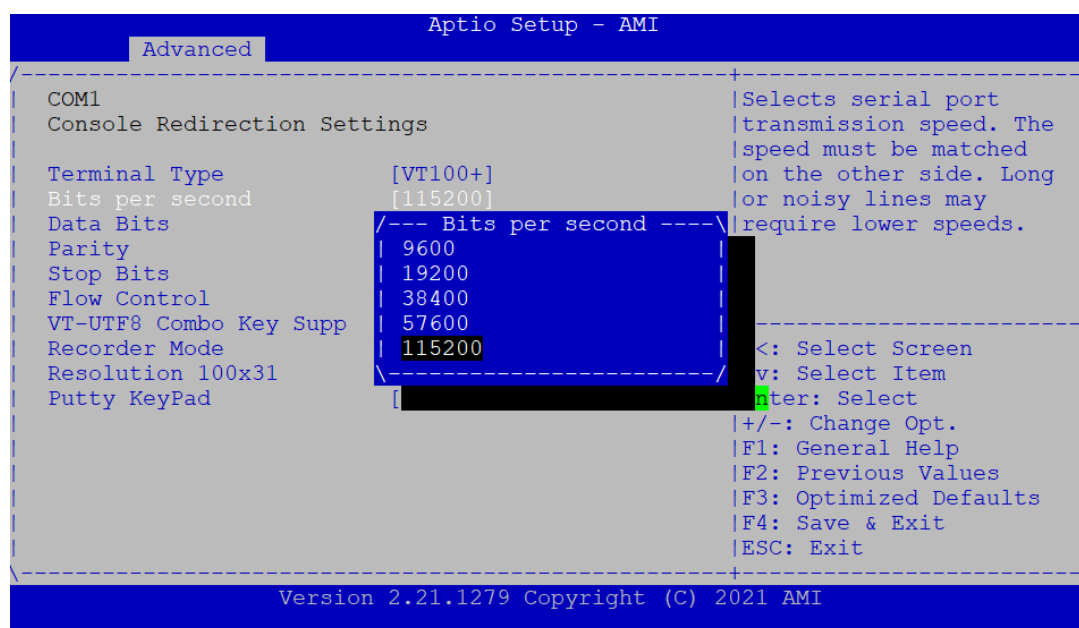

### Terminal Type

This item allows you to select the target terminal type. Configuration options: ANSI, VT100, VT100+ and VT-UTF8.

### Bits per second

This item allows you to setup the data transfer rate for the console port. The default value is 115200. Available options are "9600", "19200", "38400", "57600" and "115200".

### Flow Control

This item allows you to select flow control for console redirection. The configuration options: None and Hardware RTS/CTS.

### VT-UTF8 Combo Key Support

Use this item to Enabled and Disabled VT-UTF8 combination key supports for ANSI / VT100 terminals.

### Recorder Mode

This item allows you to select the recorder mode. The configuration options: Enabled and Disabled.

### Resolution 100x31

This item allows you to select the data bits. The configuration options: 7 and 8.

### Putty Keypad

This item allows you to select the putty keypad. The configuration options: VT100, LINUX, XTERMR6, SCO, ESCN and VT400.

### Install Legacy OS through Remote

This item allows you to select the install legacy OS through remote. The configuration options: "Enabled" or "Disabled".

### Redirection After POST

Use this item to enable or disable the function of Console Redirection, which allows you maintain a system from a remote location. The default setting is *Always*.

**PCI Subsystem Setting**

This screen allows you to set PCI Subsystem mode

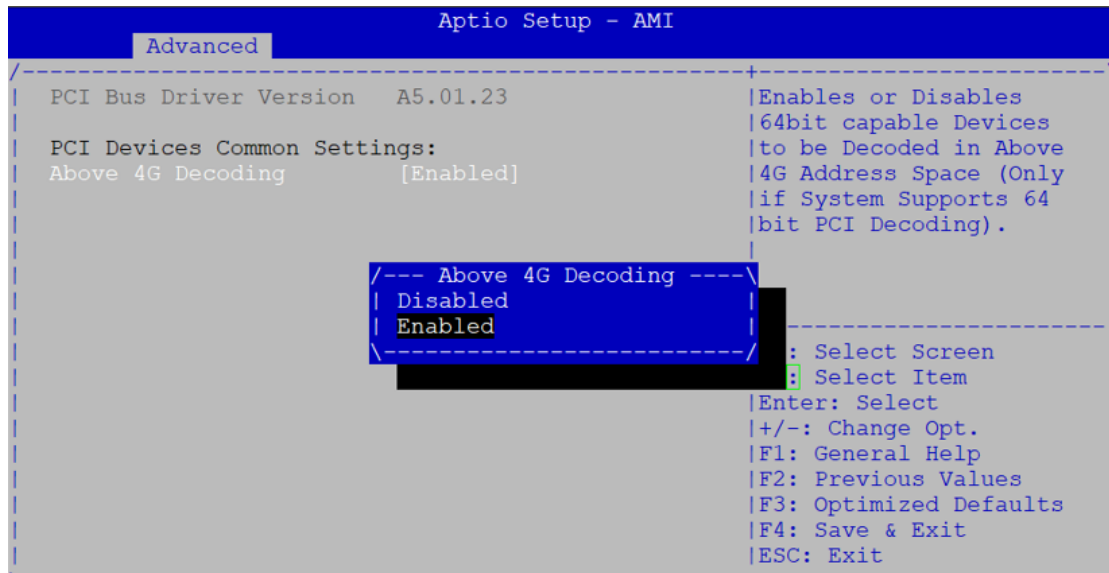
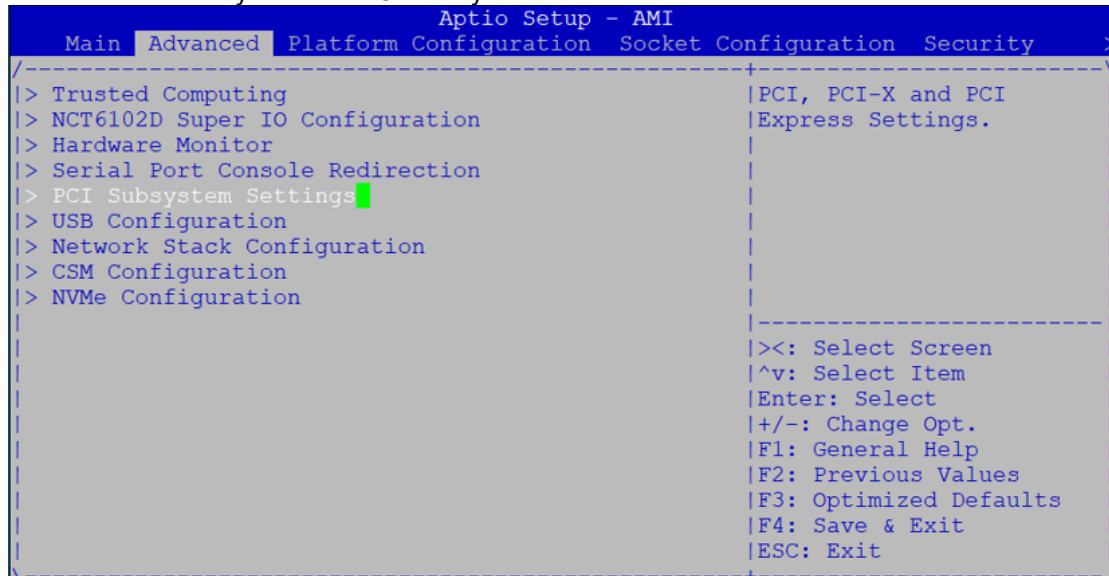

**Above 4G Decoding**

Using this item to **enable** or disable above 4G decoding.

### USB Configuration

Use this item for further setting USB port configuration.

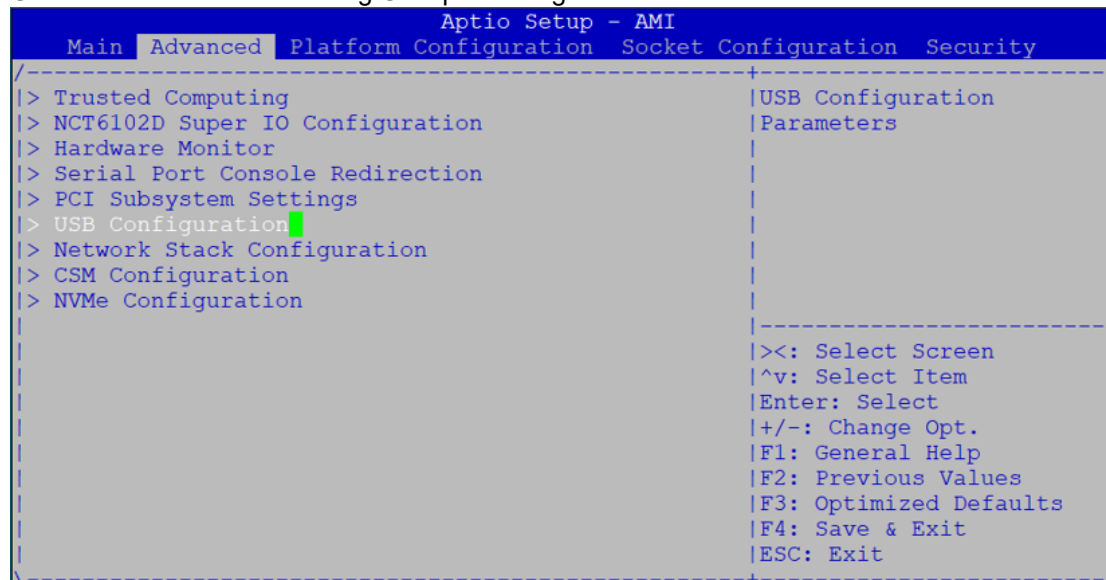

### Legacy USB Support

Due to the limited space of the BIOS ROM, the support for legacy USB keyboard (in DOS mode) is by default set to Disabled. With more BIOS ROM space available, it will be able to support more advanced features as well as provide compatibility to a wide variety of peripheral devices. Configuration options: Auto, Enabled and Disabled.

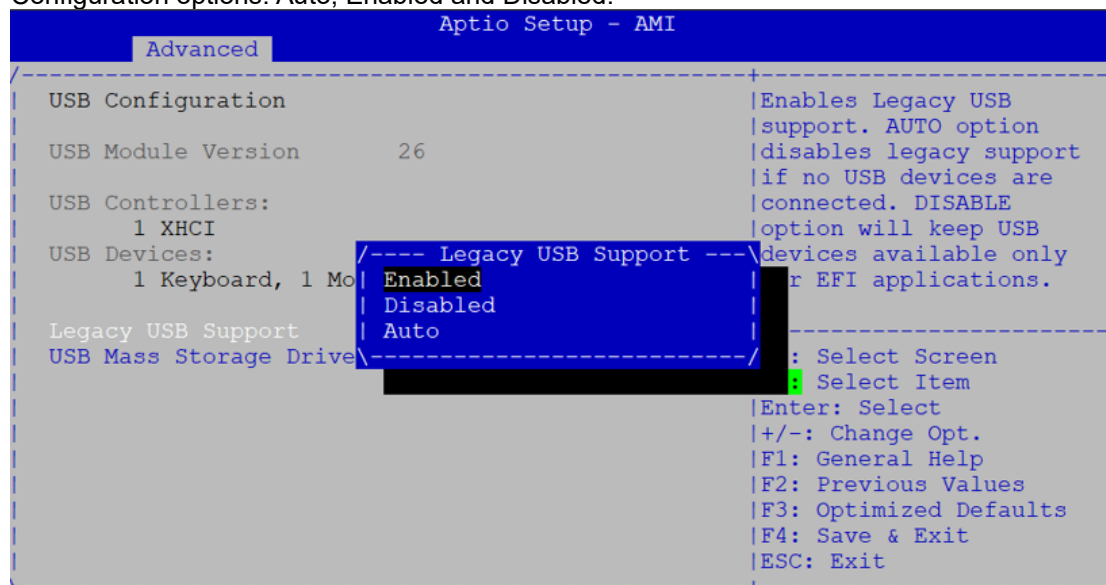

**Network Stack Configuration**

On this screen, you can select PXE LAN port

```

Aptio Setup - AMI
Main  Advanced  Platform Configuration  Socket Configuration  Security >
-----
|> Trusted Computing
|> NCT6102D Super IO Configuration
|> Hardware Monitor
|> Serial Port Console Redirection
|> PCI Subsystem Settings
|> USB Configuration
|> Network Stack Configuration
|> CSM Configuration
|> NVMe Configuration

|-----|
|><: Select Screen
|^v: Select Item
|Enter: Select
|+/-: Change Opt.
|F1: General Help
|F2: Previous Values
|F3: Optimized Defaults
|F4: Save & Exit
|ESC: Exit
    
```

```

Aptio Setup - AMI
Advanced
-----
Network Stack      [Disabled]
PXE LAN Port      [LAN1]

|-----|
|><: Select Screen
|^v: Select Item
|Enter: Select
|+/-: Change Opt.
|F1: General Help
|F2: Previous Values
|F3: Optimized Defaults
|F4: Save & Exit
|ESC: Exit
    
```

/--- Network Stack ---\  
 Disabled  
 Enabled

### CSM Configuration

This screen shows the CSM Configuration, and you can enable/disable option ROM execution settings.

```

Aptio Setup - AMI
Main  Advanced  Platform Configuration  Socket Configuration  Security >
-----
|> Trusted Computing
|> NCT6102D Super IO Configuration
|> Hardware Monitor
|> Serial Port Console Redirection
|> PCI Subsystem Settings
|> USB Configuration
|> Network Stack Configuration
|> CSM Configuration
|> NVMe Configuration

CSM configuration:
Enable/Disable, Option
ROM execution settings,
etc.

-----
><: Select Screen
^v: Select Item
Enter: Select
+/-: Change Opt.
F1: General Help
F2: Previous Values
F3: Optimized Defaults
F4: Save & Exit
ESC: Exit
    
```

```

Aptio Setup - AMI
Advanced
-----
Compatibility Support Module Configuration
CSM Support [Enabled]
CSM16 Module Version 07.84
LBP@PowerOn(All SEG) [Last State]
LBP@PowerOff(All SEG) [--- CSM Support ---]
PCIe LAN IO Resource [Disabled]
Boot option filter [Enabled]
Option ROM execution
Network [Do not launch]
Storage [Legacy]
Video [Legacy]
Other PCI devices [Legacy]

Enable/Disable CSM
Support.

-----
><: Select Screen
^v: Select Item
Enter: Select
+/-: Change Opt.
F1: General Help
F2: Previous Values
F3: Optimized Defaults
F4: Save & Exit
ESC: Exit
    
```



**LBP @PowerOn (All SEG)**

For Power On LAN Bypass setting, use LBP @PowerOn item to "Disable", "Enabled" or "Last State" for LAN Bypass all segments.

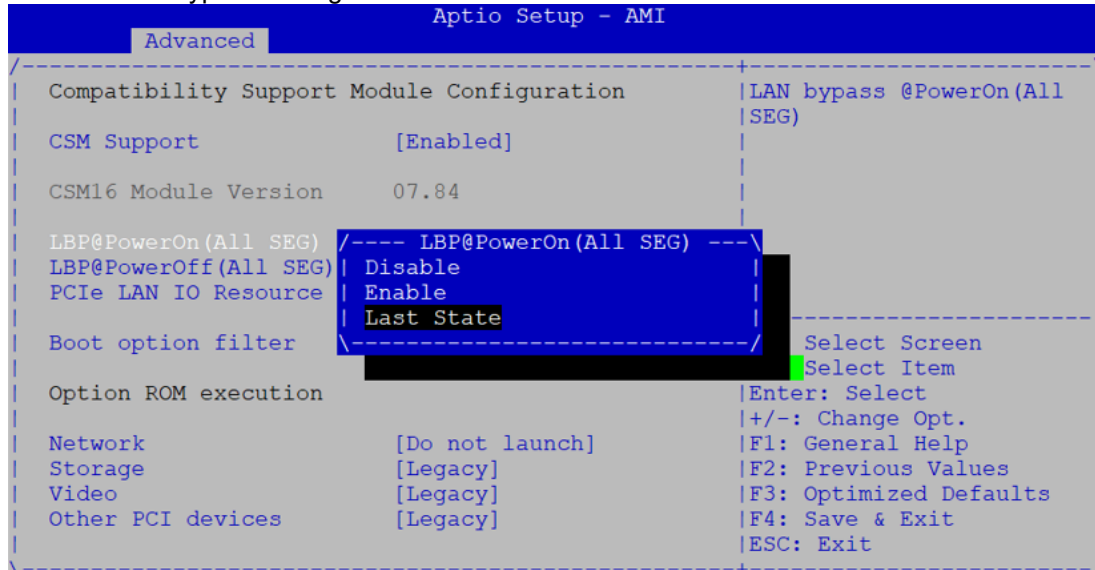

### LBP @Power Off (All SEG)

For Power off LAN Bypass setting, use LBP @PowerOff item to “Disabled”, “Enabled” or “Last State” for LAN Bypass all segments.

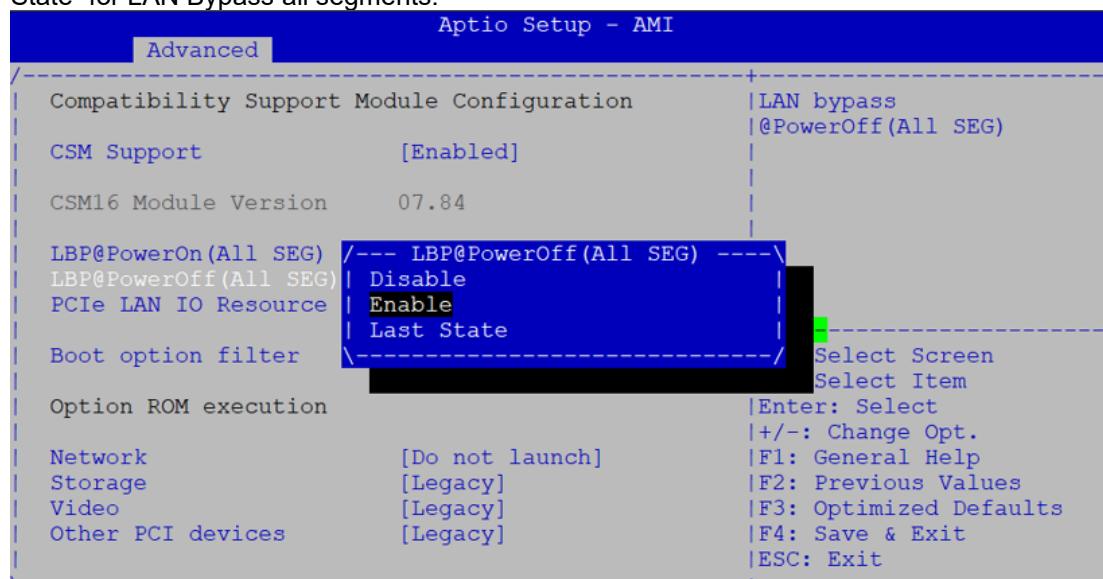

### PCIe LAN IO Resource

For LAN IO Resource setting, use item to select “Disabled” or “Enabled” mode.

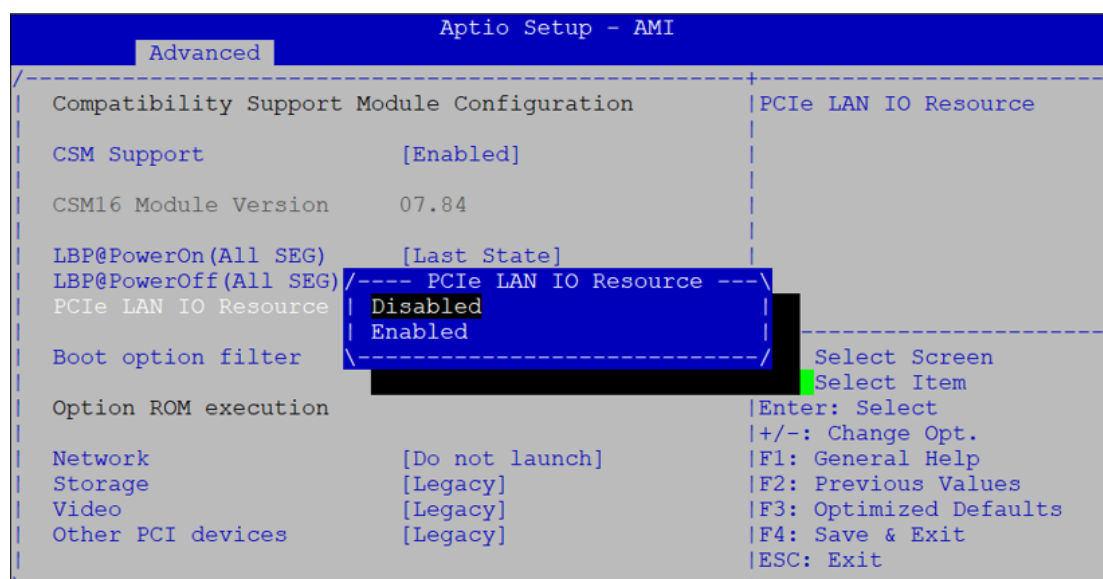

### Boot option filter

This option controls Legacy/UEFI ROMs priority.

### Network

For Network setting, use Network item to “Do not launch” or “UEFI” or “legacy” mode.

### Storage

Controls the execution of UEFI and Legacy Storage OpROM

### Video

Controls the execution of UEFI and Legacy Video OpROM.

### Other PCI devices

Determines OpROM execution policy for devices other than Network, Storage, or Video

## NVMe Configuration

```

Aptio Setup - AMI
Main  Advanced  Platform Configuration  Socket Configuration  Security
-----
|> Trusted Computing
|> NCT6102D Super IO Configuration
|> Hardware Monitor
|> Serial Port Console Redirection
|> PCI Subsystem Settings
|> USB Configuration
|> Network Stack Configuration
|> CSM Configuration
|> NVMe Configuration
-----
|> NVMe Device Options
|> Settings
-----
|><: Select Screen
|^v: Select Item
|Enter: Select
|+/-: Change Opt.
|F1: General Help
|F2: Previous Values
|F3: Optimized Defaults
|F4: Save & Exit
|ESC: Exit

```

This screen displays NVMe information.

```

Aptio Setup - AMI
Advanced
-----
| NVMe controller and Drive information
|
| Bus:1 Dev:0 Func:0      KINGSTON OM8PDP364B-...
| Nvme Size              64.0GB
|
| Bus:6 Dev:0 Func:0      TS1TMTE662T
| Nvme Size              1024.2GB
|
-----
|><: Select Screen
|^v: Select Item
|Enter: Select
|+/-: Change Opt.
|F1: General Help
|F2: Previous Values
|F3: Optimized Defaults
|F4: Save & Exit
|ESC: Exit

```

### 3.5 Platform Configuration

The Chipset menu allows users to change the advanced chipset settings. You can select any of the items in the left frame of the screen to go to the sub menus:

- ▶ PCH Configuration
- ▶ Miscellaneous Configuration
- ▶ Server ME Configuration

For items marked with “▶”, please press <Enter> for more options.

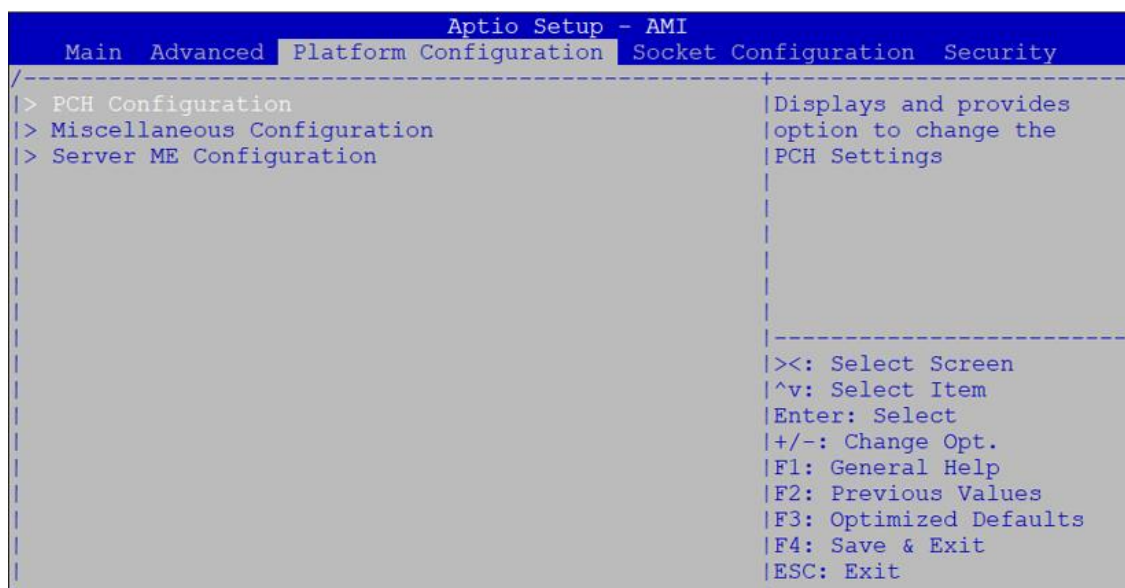

**PCH Configuration**

You can select any of the items in the screen:

**PCH SATA Configuration**

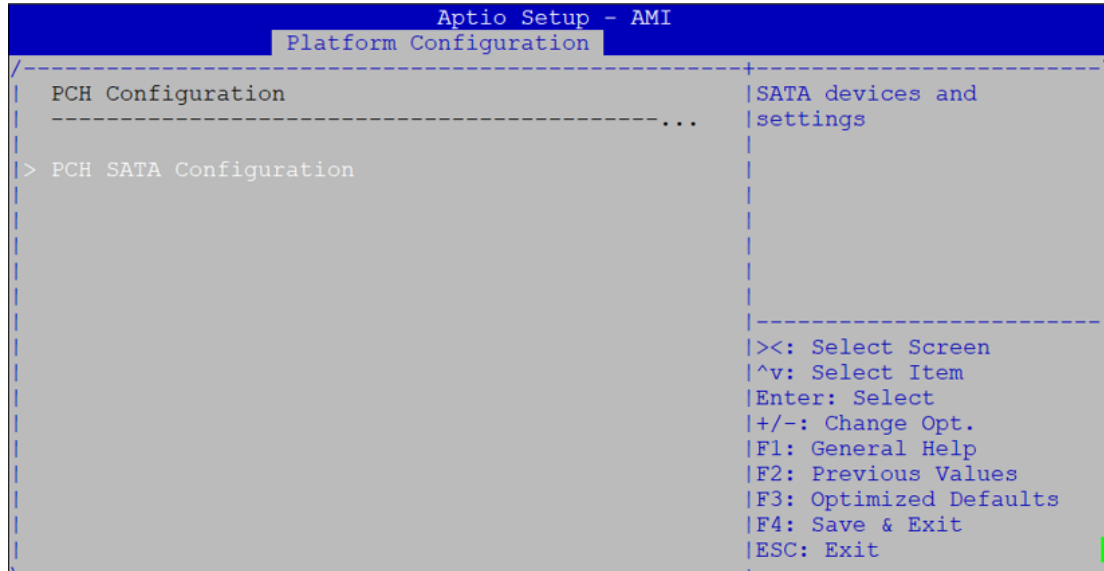

**PCH SATA Configuration**

**SATA Controller**

This item allows you to select the SATA controller. Configuration options: "Enabled" or "Disabled".

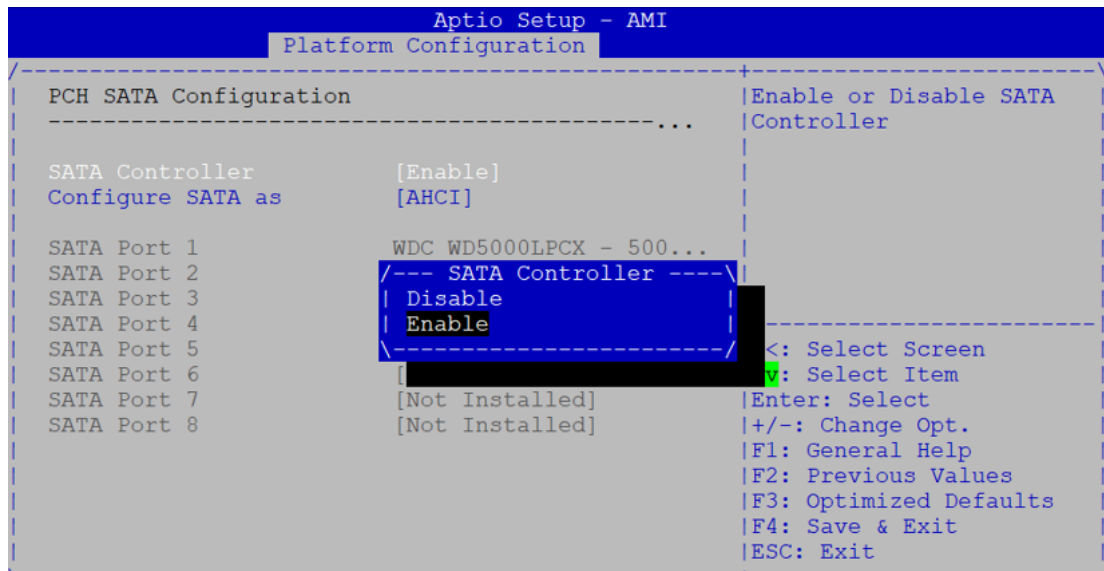

### Configure SATA

The item allows you to select the configure SATA. Configuration options: AHCI. & RAID mode. AHCI mode allows the onboard storage driver to enable advanced SATA features that increases storage performance or workloads where multiple simultaneous read/ write requests are outstanding, most often occurring in server-type applications.

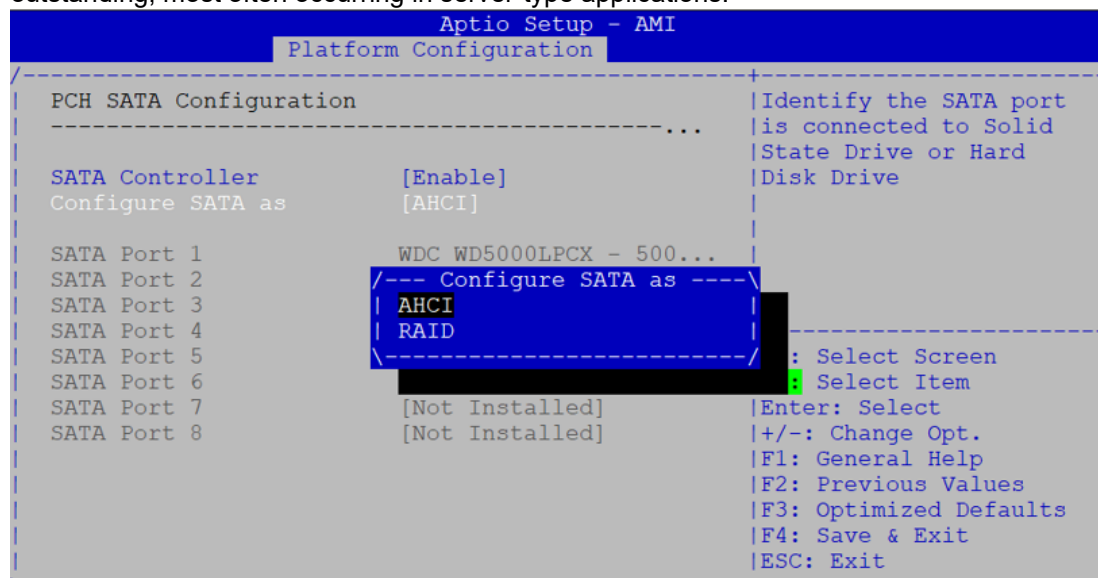

### Miscellaneous Configuration

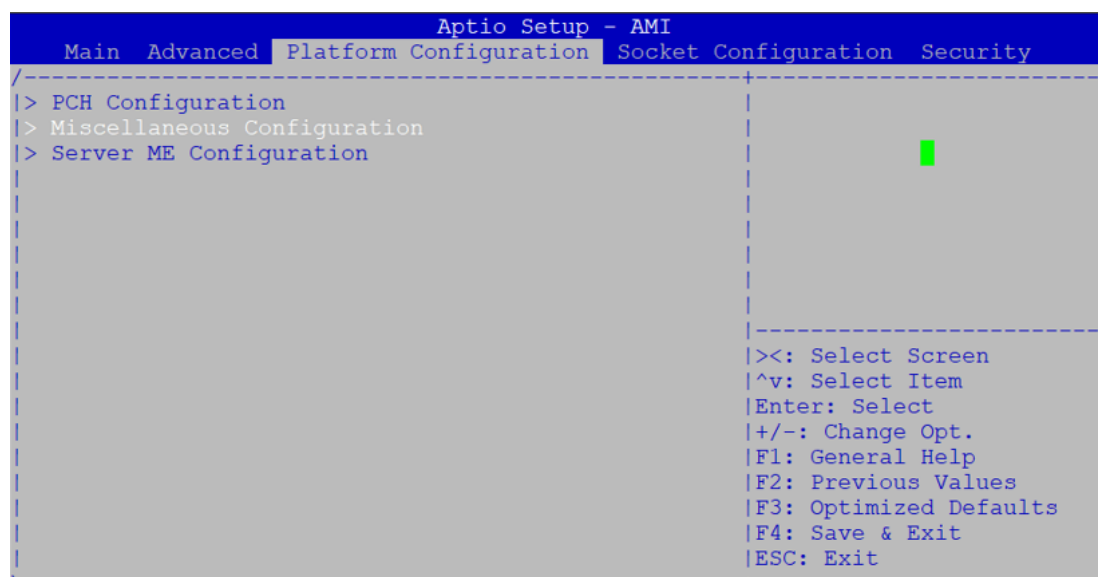

This screen displays the Active Video information.

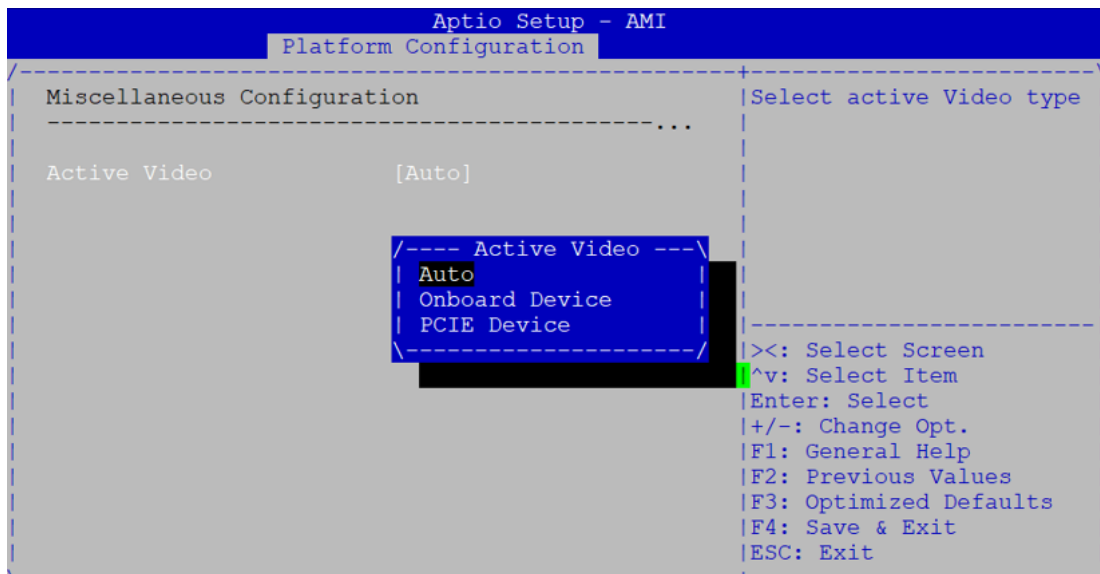

**Server ME Configuration**

```

Aptio Setup - AMI
Main Advanced Platform Configuration Socket Configuration Security
|> PCH Configuration |Configure Server ME
|> Miscellaneous Configuration |Technology Parameters
|> Server ME Configuration
|
|
|
|
|
|
|><: Select Screen
|^v: Select Item
|Enter: Select
|+/-: Change Opt.
|F1: General Help
|F2: Previous Values
|F3: Optimized Defaults
|F4: Save & Exit
|ESC: Exit
    
```

```

Aptio Setup - AMI
Platform Configuration
General ME Configuration
Oper. Firmware Version 0F:4.4.3.263
Backup Firmware Versio N/A
Recovery Firmware Vers 0F:4.4.3.263
ME Firmware Status #1 0x000F0255
ME Firmware Status #2 0x89118026
Current State Operational
Error Code No Error
Recovery Cause N/A
|
|
|
|
|
|><: Select Screen
|^v: Select Item
|Enter: Select
|+/-: Change Opt.
|F1: General Help
|F2: Previous Values
|F3: Optimized Defaults
|F4: Save & Exit
|ESC: Exit
    
```



### 3.6 Socket Configuration

The Chipset menu allows users to change the advanced chipset settings. You can select any of the items in the left frame of the screen to go to the sub menus:

- ▶Processor Configuration
- ▶Memory Configuration
- ▶IIO Configuration

For items marked with “▶”, please press <Enter> for more options.

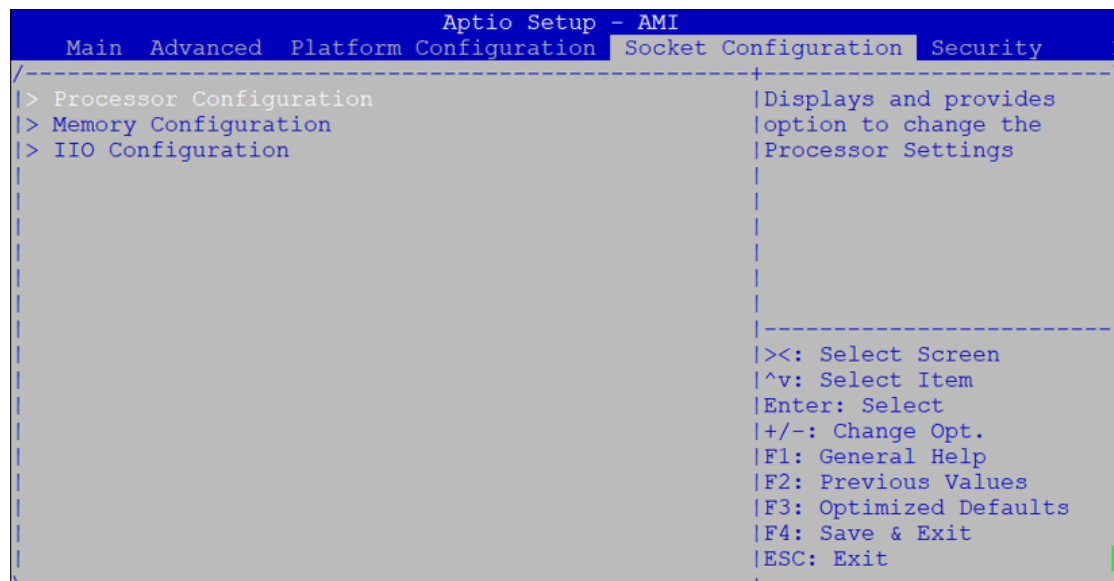

#### Processor Configuration

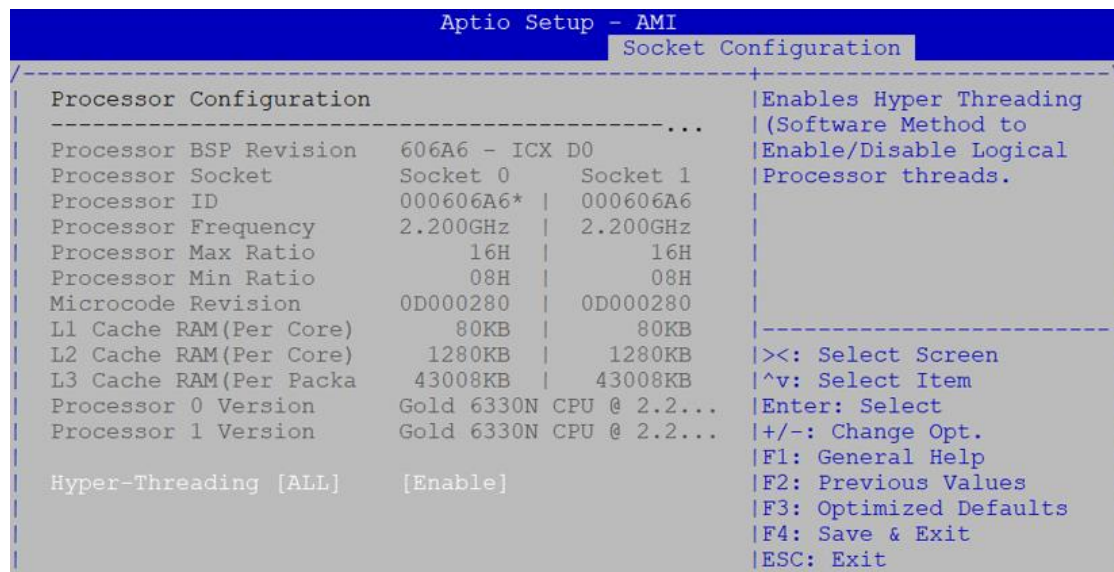

```

Aptio Setup - AMI
Socket Configuration
-----
Processor Configuration
-----
Processor BSP Revision 606A6 - ICX D0
Processor Socket      Socket 0      Socket 1
Processor ID          000606A6* | 000606A6
Processor Frequency   2.200GHz | 2.200GHz
Processor Max Ratio   16H | 16H
Processor Min Ratio   /--- Hyper-Threading [ALL] ---\
Microcode Revision   | Disable
L1 Cache RAM(Per Core) | Enable
L2 Cache RAM(Per Core) |
L3 Cache RAM(Per Packa |
Processor 0 Version   Gold 6330N CPU @ 2.2...
Processor 1 Version   Gold 6330N CPU @ 2.2...
Hyper-Threading [ALL] [Enable]

Enables Hyper Threading
(Software Method to
Enable/Disable Logical
Processor threads.

Select Screen
Select Item
Enter: Select
+/-: Change Opt.
F1: General Help
F2: Previous Values
F3: Optimized Defaults
F4: Save & Exit
ESC: Exit
    
```

**Memory Configuration**

```

Aptio Setup - AMI
Main Advanced Platform Configuration Socket Configuration Security >
-----
|> Processor Configuration
|> Memory Configuration
|> IIO Configuration

Displays and provides
option to change the
Memory Settings

-----
><: Select Screen
^v: Select Item
Enter: Select
+/-: Change Opt.
F1: General Help
F2: Previous Values
F3: Optimized Defaults
F4: Save & Exit
ESC: Exit
    
```

This item displays the memory information.

```

-----
CPU0.ChC.D0: 2666MT/s Transcend DRx4 32GB RDIMM
CPU0.ChD.D0: 2666MT/s Transcend DRx4 32GB RDIMM
CPU1.ChC.D0: 2666MT/s Transcend DRx4 32GB RDIMM
CPU1.ChG.D0: 2666MT/s Transcend DRx4 32GB RDIMM
-----
...

|><: Select Screen
|^v: Select Item
|Enter: Select
|+/-: Change Opt.
|F1: General Help
|F2: Previous Values
|F3: Optimized Defaults
|F4: Save & Exit
|ESC: Exit

```

### IIO Configuration

```

Aptio Setup - AMI
Main Advanced Platform Configuration Socket Configuration Security >
-----
|> Processor Configuration |Displays and provides
|> Memory Configuration |option to change the
|> IIO Configuration |IIO Settings
-----
|><: Select Screen
|^v: Select Item
|Enter: Select
|+/-: Change Opt.
|F1: General Help
|F2: Previous Values
|F3: Optimized Defaults
|F4: Save & Exit
|ESC: Exit

```

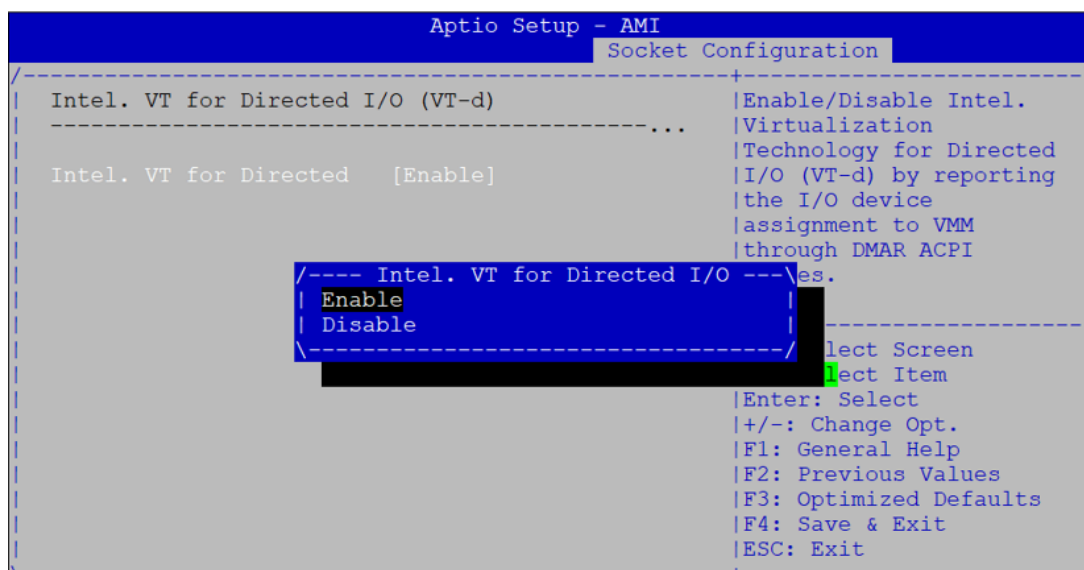

### 3.7 Security Menu

The Security menu allows users to change the security settings for the system.

#### Administrator Password

This item indicates whether an administrator password has been set. If the password has been installed, Installed displays. If not, Not Installed displays.

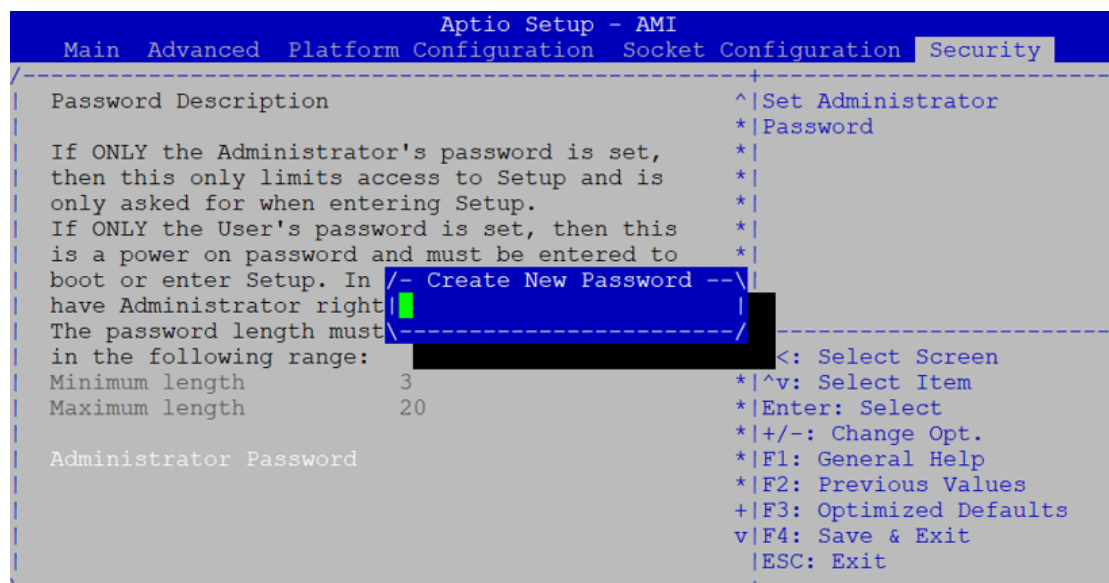

## 3.8 Boot Menu

The Boot menu allows users to change boot options of the system. You can select any of the items in the left frame of the screen to go to the sub menus:

### Setup Prompt Timeout

Number of seconds to wait for setup activation key.

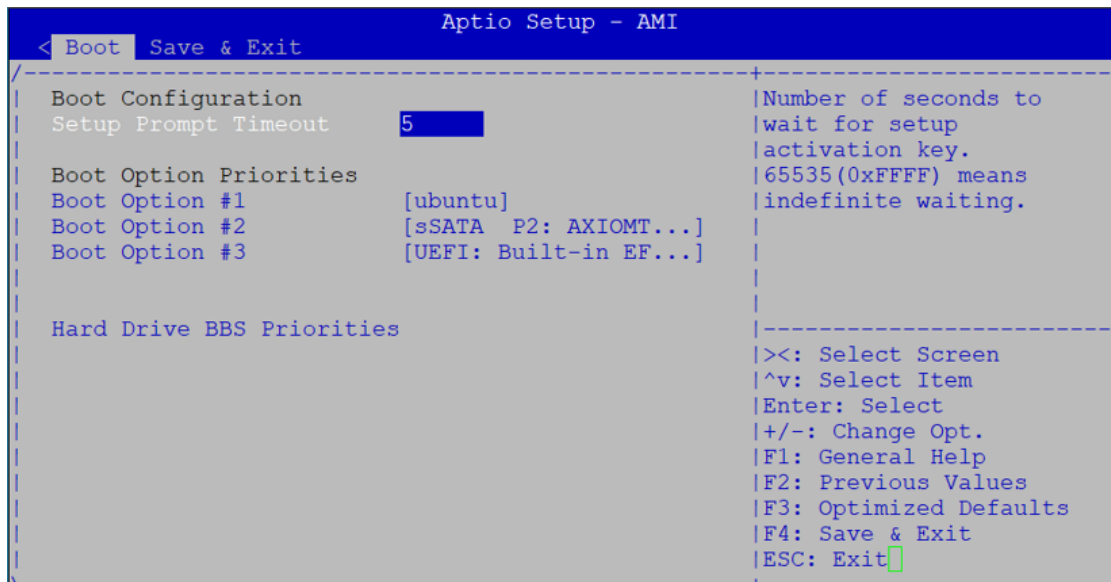

### Boot Option Priorities

You could set the system boot order of the legacy devices in this group. You could set the system boot order in option #1 UEFI or Disabled

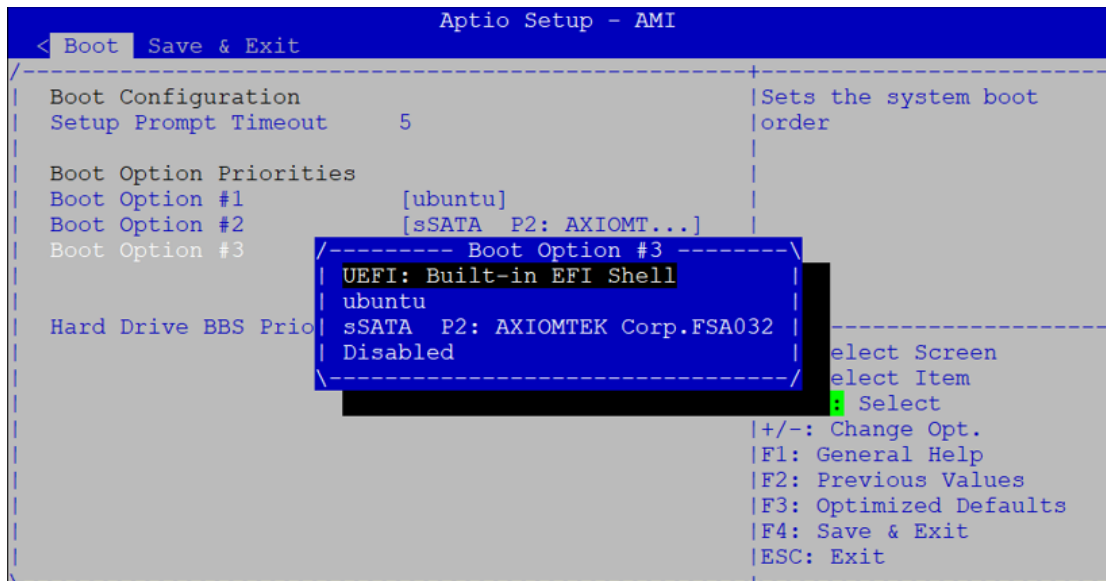

### 3.9 Save & Exit Menu

The Save & Exit menu allows users to load your system configuration with optimal or fail-safe default values.

#### Save Changes and Exit

When you have completed the system configuration changes, select this option to leave Setup and return to Main Menu. Select Save Changes and Exit from the Save & Exit menu and press <Enter>. Select Yes to save changes and exit.

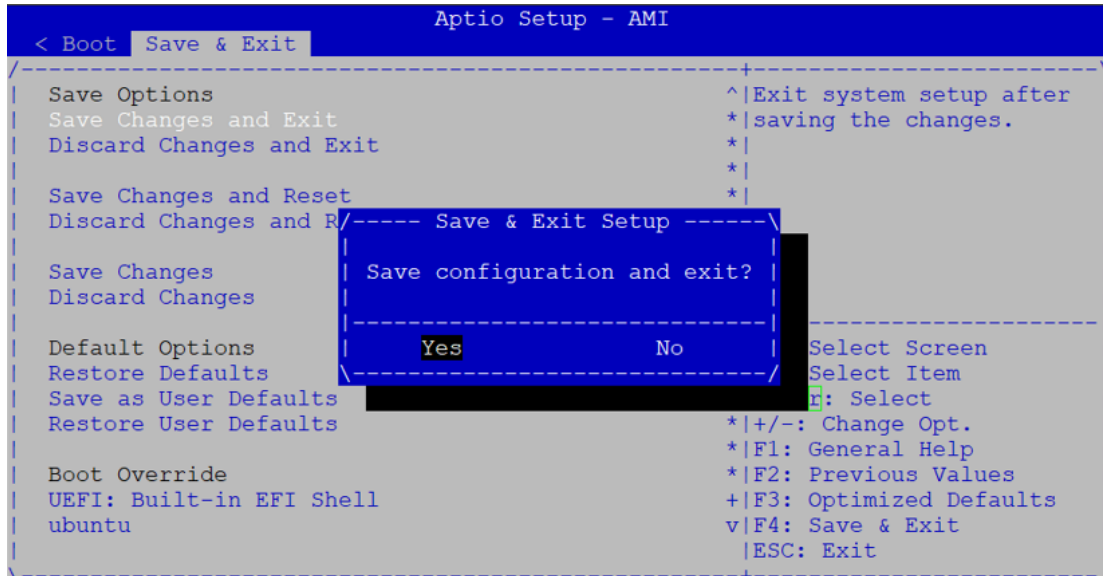

### Discard Changes and Exit

Select this option to quit Setup without making any permanent changes to the system configuration and return to Main Menu. Select Discard Changes and Exit from the Save & Exit menu and press <Enter>. Select Yes to discard changes and exit.

### Save Changes

When you have completed the system configuration changes, select this option to save changes. Select Save Changes from the Save & Exit menu and press <Enter>. Select Yes to save changes.

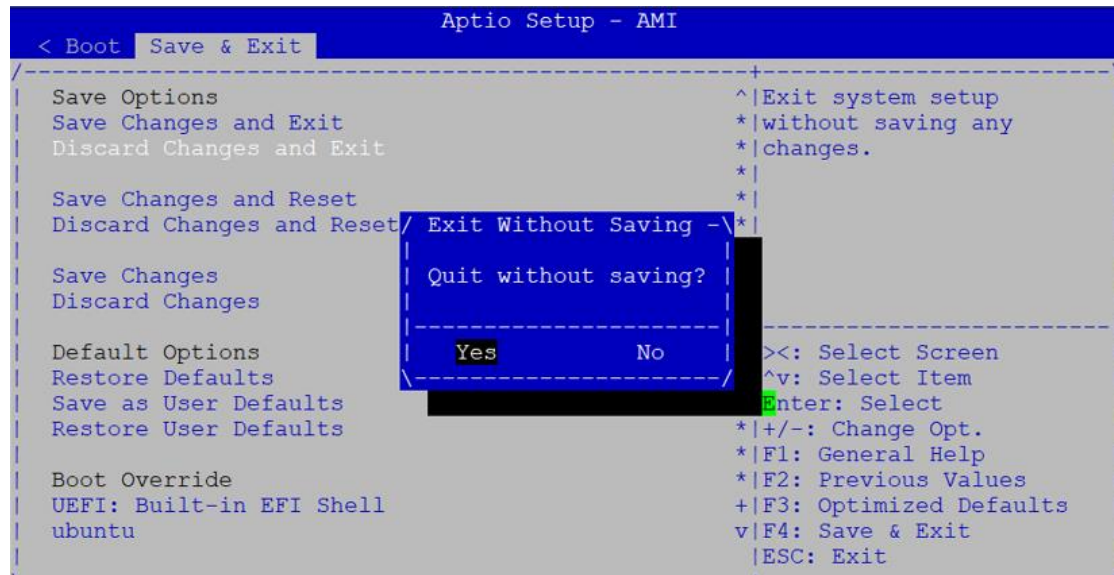



**Discard Changes**

Select this option to quit Setup without making any permanent changes to the system configuration. Select Discard Changes from the Save & Exit menu and press <Enter>. Select Yes to discard changes.

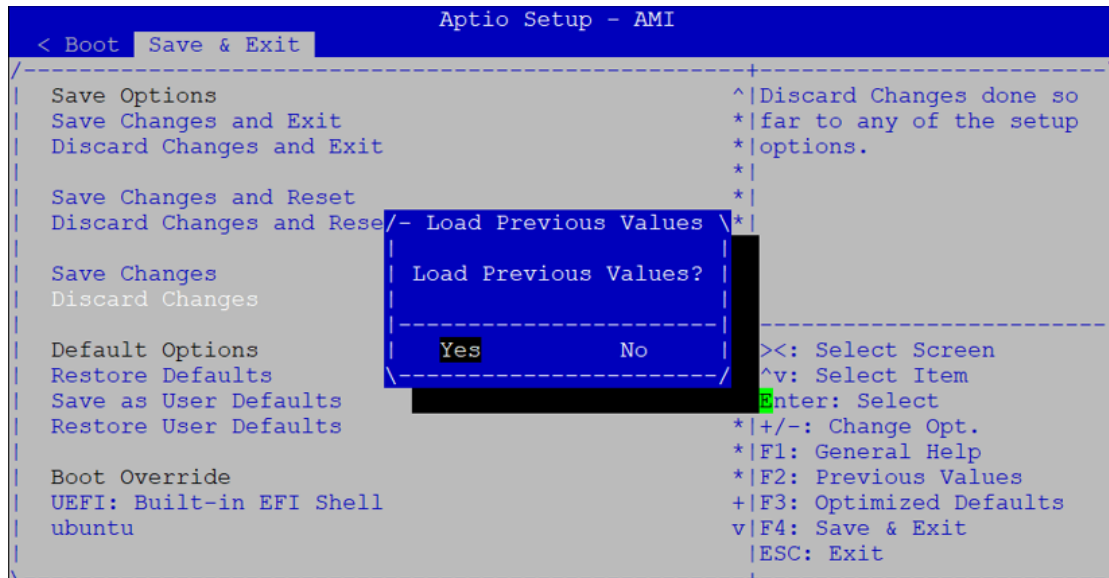

**Restore Defaults**

It automatically sets all Setup options to a complete set of default settings when you select this option. The Optimal settings are designed for maximum system performance but may not work best for all computer applications. In particular, do not use the Optimal Setup options if your computer is experiencing system configuration problems. Select Restore Defaults from the Save & Exit menu and press <Enter>.

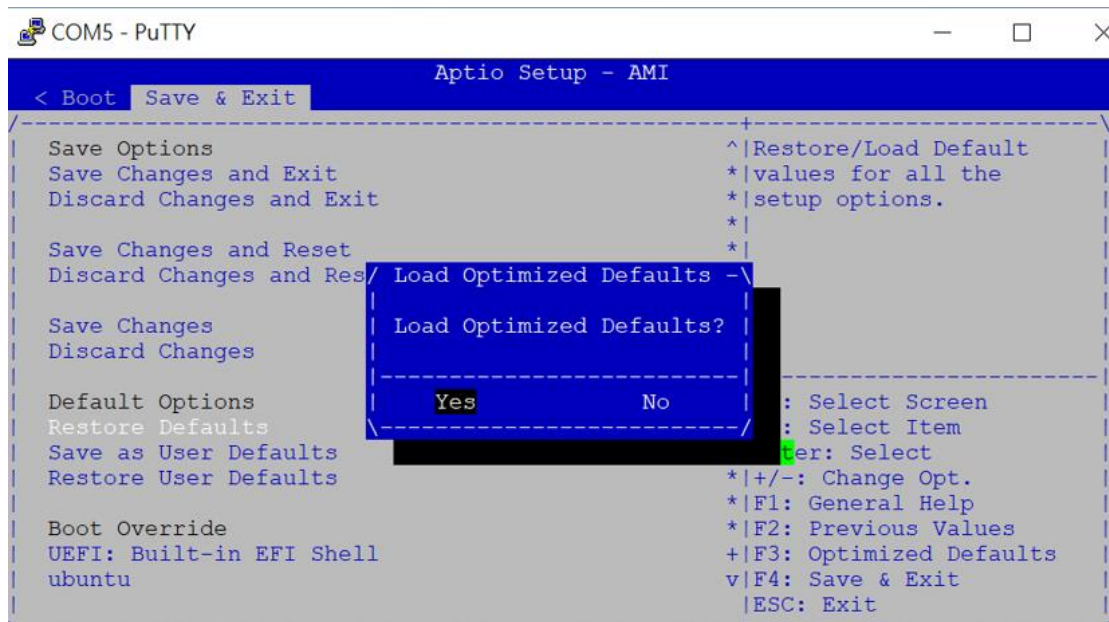

### Save as User Defaults

Select this option to save system configuration changes done so far as User Defaults. Select Save as User Defaults from the Save & Exit menu and press <Enter>.

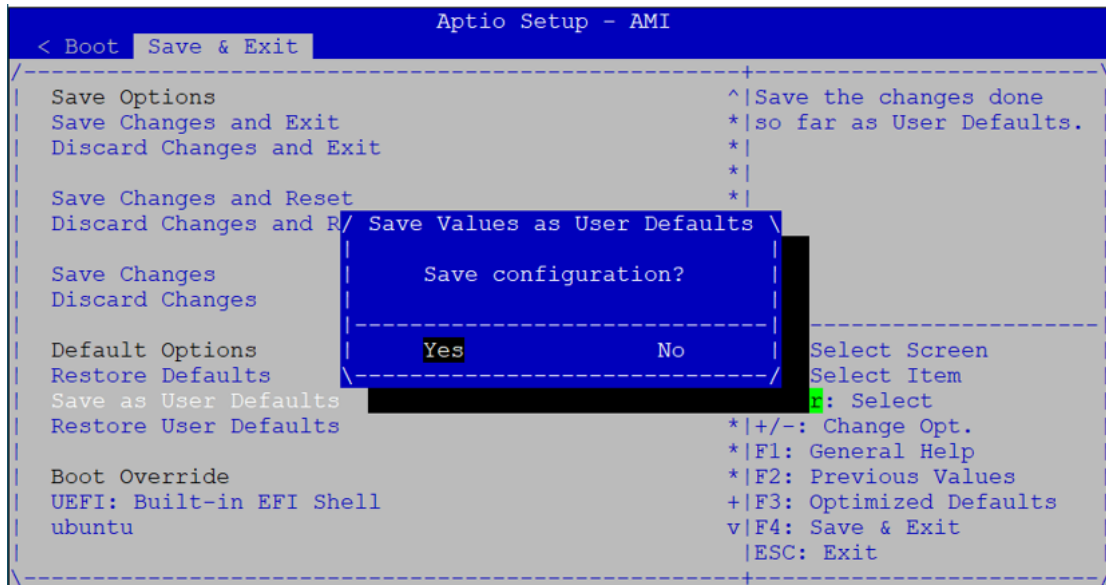

### Restore User Defaults

It automatically sets all Setup options to a complete set of User Defaults when you select this option. Select Restore User Defaults from the Save & Exit menu and press <Enter>.

# Appendix A

## LAN Bypass Configuration

### About LAN Bypass

In network security application, it is very important to ensure that network traffic to continue passing through the device even if hardware failure occurs or operating system crashes. LAN bypass gives us a solution for this problem.

The NA870 series LAN bypass function is very flexible. It can be selected at any time and any stage. You can enable LAN bypass for power on state by BIOS, or by software program when entering into the OS.

Moreover, for power off state, you can set up LAN Bypass through BIOS, or use software program when entering into the OS. If you don't do any change, the state will keep the previous power off state.

The NA870 has LAN bypass capability with the special designed latch relay circuitry. When LAN bypass function is enabled, a relay closes to act as a bridge to route network data flow between module's LAN port 0 and LAN port 1 (or LAN port 2 and LAN port 3....), see below image. The bypass feature can be activated immediately or according to timer which is configurable from 1 up to 64 seconds. You can write a software program to control bypass operation behavior to fit your requirement.



**Note:** If you need sample codes, please contact our FAE directly. And they are for reference purposes only.

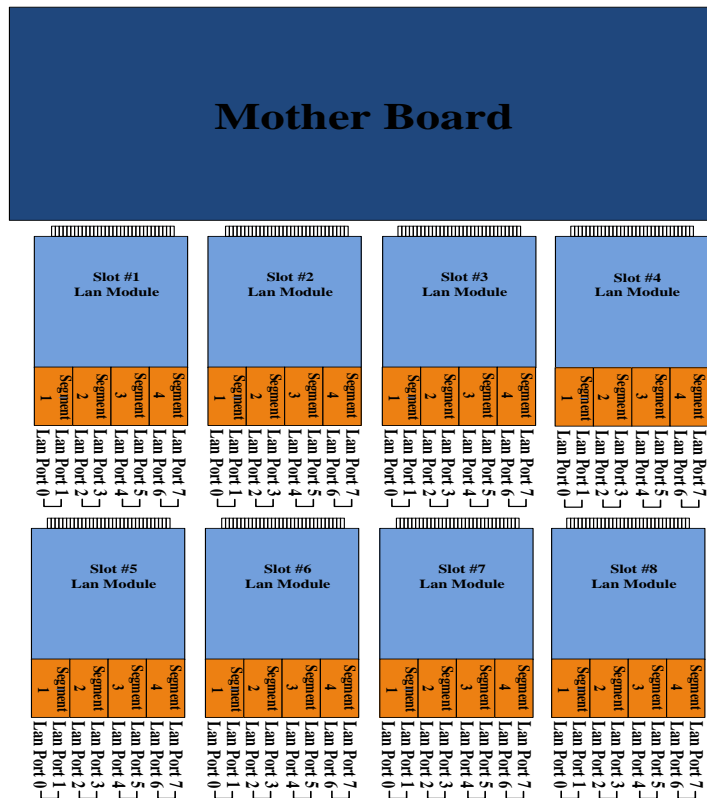

**Slot & I2C Switch Address of SMBus**

Slot Number	Slot 1	Slot 2	Slot 3	Slot 4	Slot 5	Slot 6	Slot 7	Slot 8
I2C Switch 1 Address (Master)	0x70							
Channel No (Master)	0x01	0x02	0x04	0x08	0x10			
I2C Switch 2 Address (Slave)	0x74							
Channel No (Slave)					0x01	0x02	0x04	0x08
Slot Address	0x67	0x6F	0x77	0x5F	0x66	0x6E	0x76	0x5E

**LAN Bypass Register Configuration**

- **Power ON Bypass Control Register**

Address: 0x13

7	6	5	4	3	2	1	0
BYM1	BYM0	X	X	SEGN4	SEGN3	SEGN2	SEGN1
W	W	--	--	W	W	W	W

Default value: 00000000

Bit 7~6 BYM1~0

These bits are used to set bypass mode.

00 Not used.

01 Force bypass enable

Relay closes immediately to form LAN bypass on selected segment when power on.

10 Force bypass disable

LAN bypass is disabled immediately on selected segment when power on.

11 Timer enables

When power on, the selected segments are controlled by the setting of LAN bypass Timer Control register.

Bit 5~4 Not used.

Bits 3~0 SEGN4~1

Select each segment by setting the corresponding bit to 1. When the bit is set to 0, no action happens upon the segment.

Data read back from this register is not defined and therefore must be ignored. Reading from this register makes no effect on LAN bypass function. All data in this register will be cleared when system is turned off. If you still want to use power on LAN bypass function, turn on the system and make sure to rewrite the register. Otherwise, if you don't rewrite the register, the status will be kept on power off bypass state.

**Power OFF Bypass Control Register**

Address: 0x14

7	6	5	4	3	2	1	0
X	X	X	X	SEGF4	SEGF3	SEGF2	SEGF1
--	--	--	--	W	W	W	W

Default value: 00000000

Bit 7~4 Not used.

Bits3~0 SEGF4~1

Use the corresponding bit to configure each segment. Setting the bit to 1 enables LAN bypass on the segment when power off. Clearing the bit to 0 disables LAN bypass on the segment when power off.

Data read back from this register is not defined and therefore must be ignored. Reading from this register makes no effect on LAN bypass function. When system is turned off, last data written onto this register will be kept. If you want to make any change, turn on the system and make sure to reconfigure the register.

**LAN Bypass Timer Control Register**

Address: 0x12

7	6	5	4	3	2	1	0
TEXP	X	X	X	X	TVAL2	TVAL1	TVAL0
R	--	--	--	--	W	W	W

Default value: 00000000

Bit 7 TEXP (Read Only)

This bit indicates status of hardware timer.

0 Timer has not expired

1 Timer has expired

Bits 6~3 Not used.

Bits 2~0 TVAL2~0

These bits determine the amount of count value in second(s).

- 001 1 (sec)
- 010 2 (sec)
- 011 4 (sec)
- 100 8 (sec)
- 101 16 (sec)
- 110 32 (sec)
- 111 64 (sec)
- 000 Timer is not activated.

Writing a value to these bits will reset the hardware timer. The counting process begins again according to the new written value. Software must write count value periodically to ensure that timer will never expire. If timer timeout occurs, relay(s) automatically close to form LAN bypass on selected segment(s) based on the setting of Power on Bypass Control register (SEGN4~SEGN1).

Data (bits 6~0) read back from this register is not defined and therefore must be ignored. A read operation upon this register should not refresh the hardware timer.

**LAN Bypass Status / Firmware Version Register**

Address: 0x15

7	6	5	4	3	2	1	0
VER3	VER2	VER1	VER0	BY4	BY3	BY2	BY1
R	R	R	R	R	R	R	R

Bit3~0 Lan Bypass Seg.1 status → Disable=0; Enable=1

Bit 7~4 Firmware version  
Without Lan bypass function=1111

**How to select slot via i2c-tools**

● **For example:**

- i2cset -y <SMBus No.> <I2C Switch 1 address > <Channel No.>
- Slot 1  
# i2cset -y 1 0x70 0x01
- Slot 2  
# i2cset -y 1 0x70 0x02
- Slot 3  
# i2cset -y 1 0x70 0x04
- Slot 4  
# i2cset -y 1 0x70 0x08
- i2cset -y <SMBus No.> <I2C Switch 1 address > 0x10
- i2cset -y <SMBus No.> <I2C Switch 2 address > < Channel No.>
- Slot 5  
# i2cset -y 1 0x70 0x10  
# i2cset -y 1 0x74 0x01
- Slot 6  
# i2cset -y 1 0x70 0x10  
# i2cset -y 1 0x74 0x02
- Slot 7  
# i2cset -y 1 0x70 0x10  
# i2cset -y 1 0x74 0x04
- Slot 8  
# i2cset -y 1 0x70 0x10  
# i2cset -y 1 0x74 0x08

**How to Write Power On Bypass Control Register via i2c-tools**

● **For example:**

- Select slot and Write a value 0x4F into Power ON Bypass Control Register(0x13)
- Slot 1  
# i2cset -y 1 0x70 0x01  
# i2cset -y 1 0x67 0x13 0x4F
- Slot 5  
# i2cset -y 1 0x70 0x10  
# i2cset -y 1 0x74 0x01  
# i2cset -y 1 0x66 0x13 0x4F

**How to read LAN Bypass Status / Firmware Version Register via i2c-tools**

● **For example:**

- Select slot and read value from LAN Bypass Status/Firmware Version Register(0x15)
- Slot 1

```
# i2cset -y 1 0x70 0x01  
# i2cget -y 1 0x67 0x15
```

```
➤ Slot 5  
# i2cset -y 1 0x70 0x10  
# i2cset -y 1 0x74 0x01  
# i2cget -y 1 0x66 0x15
```

**This page is intentionally left blank.**



# Appendix B

## WDT Timer for System Reset

### WDT (Watchdog Timer)

The hardware supports the WDT (Watchdog Timer) function. While time-out happens after a defaulted period, the WDT will reset the system.



***Note:*** *If you need sample codes, please contact our FAE directly. And they are for reference purposes only.*

**This page is intentionally left blank.**

# Appendix C



## LAN Module Expansion

You can install LAN module(s) into NA870's front-accessible expansion slots to meet your application requirement. Here are some LAN module configurations for your selection:

	Module	LAN Chipset	Ports	LAN Bypass (Latch Relay)	Copper/Fiber (SFP)
<b>1G</b>	AX93316-8GIL	Intel® i350	8	4	8/0
	AX93326-8GIL	Intel® i210	8	4	8/0
	AX93316-8GI	Intel® i350	8	0	8/0
	AX93322-8MIL	Intel® i350	8	2	4/4
	AX93322-8FI	Intel® i350	8	0	0/8
	AX93336-4GIL	Intel® i350	4	2	4/0
	AX93336-4FI	Intel® i350	4	0	0/4
<b>10G</b>	AX93327-4FI	Intel® XL710	4	0	0/4
	AX93307-2FI	Intel® 82599ES	2	0	0/2
	AX93307-2FIL	Intel® 82599ES	2	1	0/2
<b>25G</b>	AX93332-25FI	Intel® XXV710	2	0	0/2
<b>40G</b>	AX93331-2QFI	Intel® XL710	2	0	0/2
<b>100G</b>	AX93358	Intel® E810	2	0	0/2

- **Limitation: Single CPU only supports 4 LAN modules (Slot 1~4)**

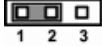
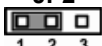
Use this jumper to select the LAN Bypass Function.

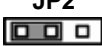
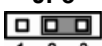
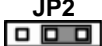
Description	Function	Jumper
LAN Bypass Trigger when Power On	All SEG. Bypass as same as Power Off status	<p><b>JP3</b></p>  <p>1 2 3</p> <p><b>JP2</b></p>  <p>1 2 3</p>
	All SEG Bypass Disable (Default)	<p><b>JP3</b></p>  <p>1 2 3</p> <p><b>JP2</b></p>  <p>1 2 3</p>
	All SEG Bypass Enable	<p><b>JP3</b></p>  <p>1 2 3</p> <p><b>JP2</b></p>  <p>1 2 3</p>



**Note:** When the system is turned on, you can select LAN bypass function by Jumper and Bios when power on state, when enter the OS, you can select LAN pass function at power on/ off state by software, the detail information please refer to the appendix A.

## LED Definition

### AX93316/AX93326



#### LAN bypass LED

While running the LAN By-Pass function, the LED always lights up.

- Active LED (Single color) for LAN port #1, port#2, port#3, port#4, port #5, port#6, port#7, port#8
  - The orange LED is on when the LAN port connection is working.
  - The LED flashes when transmitting or receiving any signals to or from the appliance.
  - The LED is dark when the appliance is off.
- Link LED for LAN port #1, port#2, port#3, port#4, port#5 and port#6, port#7, port#8
  - The double-color LED light indicates 10/100/1000Mbps transfer rate.
  - When the orange-color LED light is radiating, it should be 1000Mbps transfer rate.
  - When the green-color LED light is radiating, it should be 100Mbps transfer rate.
  - If the Link LED is dark and Active LED is light on or flashing, it should be 10Mbps transfer rate.

When this LED and Link/Active LED both are dark. No networking devices are attached

Transfer Rate	LED Light Color
10Mbps	Dark
100Mbps	Green
1000Mbps	Orange

**AX93336-4GIL**

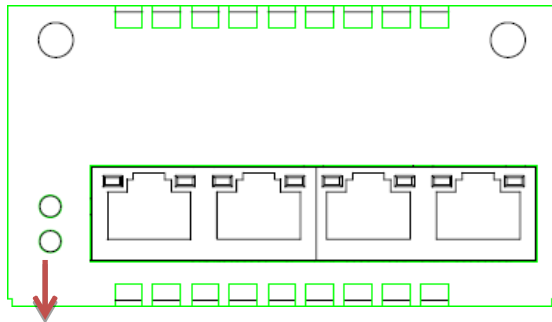

**LAN bypass LED**

- LAN bypass LED
  - While running the LAN By-Pass function, the LED always lights up.
- Active LED (Single color) for LAN port #1, port#2, port#3, port#4
  - The orange LED is on when the LAN port connection is working.
  - The LED flashes when transmitting or receiving any signals to or from the appliance.
  - The LED is dark when the appliance is off.
- Link LED for LAN port #1, port#2, port#3, port#4
  - The double-color LED light indicates 10/100/1000Mbps transfer rate.
  - When the orange-color LED light is radiating, it should be 1000Mbps transfer rate.
  - When the green-color LED light is radiating, it should be 100Mbps transfer rate.
  - If the Link LED is dark and Active LED is light on or flashing, it should be 10Mbps transfer rate.

When this LED and Link/Active LED both are dark. No networking devices are attached

Transfer Rate	LED Light Color
10Mbps	Dark
100Mbps	Green
1000Mbps	Orange

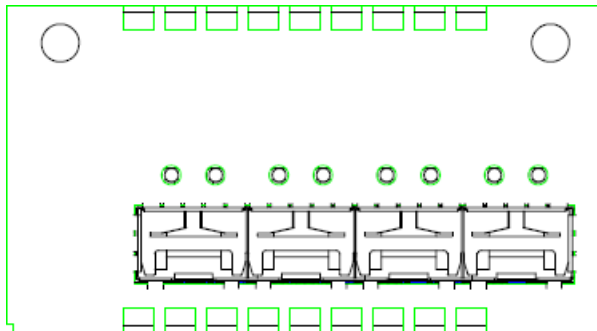

**AX93336-4FI**

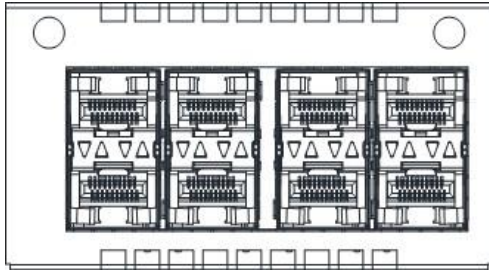

Transfer Rate	LED Light Color
	<p>Fiber port Active: Orange</p>
	<p>Fiber port Link: Orange</p>

**AX93322-8FI**

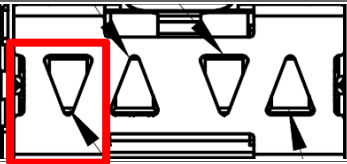
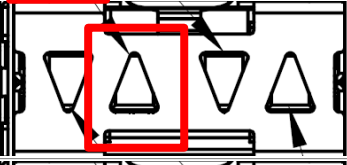

Transfer Rate	LED Light Color
	Down Fiber port Active: Orange
	Up Fiber port Active: Orange
	Down Fiber port Link: Orange
	Up Fiber port Link: Orange

**AX93322-8MIL**



**LAN bypass LED**

**FIBER:**

Transfer Rate	LED Light Color
	Down Fiber port Active: Orange
	Up Fiber port Active: Orange
	Down Fiber port Link: Orange
	Up Fiber port Link: Orange

**Copper:**

- LAN bypass LED
  - While running the LAN By-Pass function, the LED always lights up.
- Active LED (Single color) for LAN port #1, port#2, port#3, port#4
  - The orange LED is on when the LAN port connection is working.
  - The LED flashes when transmitting or receiving any signals to or from the appliance.
  - The LED is dark when the appliance is off.
- Link LED for LAN port #1, port#2, port#3, port#4
  - The double-color LED light indicates 10/100/1000Mbps transfer rate.
  - When the orange-color LED light is radiating, it should be 1000Mbps transfer rate.
  - When the green-color LED light is radiating, it should be 100Mbps transfer rate.
  - If the Link LED is dark and Active LED is light on or flashing, it should be 10Mbps transfer rate.



When this LED and Link/Active LED both are dark. No networking devices are attached

Transfer Rate	LED Light Color
10Mbps	Dark
100Mbps	Green
1000Mbps	Orange

### **AX93317**

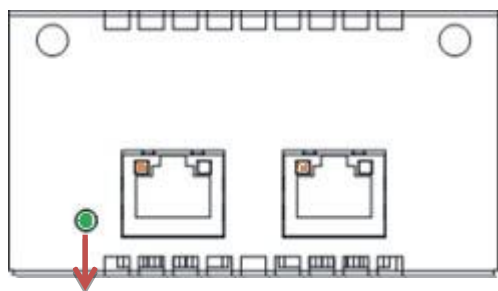

### **LAN bypass LED**

- LAN bypass LED  
While running the LAN By-Pass function, the LED always lights up.
- Active LED (Single color) for LAN port #1, port#2
  - The orange LED is on when the LAN port connection is working.
  - The LED flashes when transmitting or receiving any signals to or from the appliance.
  - The LED is dark when the appliance is off.
- Link LED for LAN port #1, port#2
  - The double-color LED light indicates 1000/10000Mbps transfer rate.
  - When the orange-color LED light is radiating, it should be 10000Mbps transfer rate.
  - When the green-color LED light is radiating, it should be 1000Mbps transfer rate.

When this LED and Link/Active LED both are dark. No networking devices are attached

Transfer Rate	LED Light Color
1000Mbps	Green
10000Mbps	Orange

**AX93307**

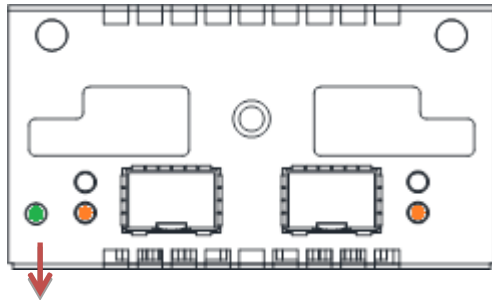

**LAN bypass LED**

- LAN bypass LED  
While running the LAN By-Pass function, the LED always lights up.
- Active LED (Single color) for LAN port #1, port#2
  - The orange LED is on when the LAN port connection is working.
  - The LED flashes when transmitting or receiving any signals to or from the appliance.
  - The LED is dark when the appliance is off.
  -
- Link LED for LAN port #1, port#2
  - The double-color LED light indicates 1000/10000Mbps transfer rate.
  - When the orange-color LED light is radiating, it should be 10000Mbps transfer rate.
  - When the green-color LED light is radiating, it should be 1000Mbps transfer rate.

When this LED and Link/Active LED both are dark. No networking devices are attached

Transfer Rate	LED Light Color
1000Mbps	Green
10000Mbps	Orange

## Appendix D

# Warning

- This is a class A Product. In a domestic Environment this Product may cause radio interference in which case the user may be required to take adequate measures.

- It will be danger if battery is incorrectly replaced. Replacing only with the same or equivalent type is highly recommended by the manufacturer. Dispose of used batteries according to the manufacturer's instructions.

- **Warning for Hard Disk Drive Selection:**  
TUV approved Hard Disk Drive is preferred for TUV compliance Hard Disk Drive-Optional, (NWGQ2), generic, Input Voltage rated 5V DC/1.0A, 12V DC/1.8A maximum. Minimum clearance from uninsulated live parts 4.0 mm.

- The equipment is to be installed in an environment with maximum ambient temperature must not exceed 40 °C
- The openings on the enclosure are for air convection hence protected the equipment from overheating. DO NOT COVER THE OPENINGS.
- Lay this equipment on a reliable surface when install. A drop or fall could cause injury.
- The equipment shall be installed according to specification as nameplate. Make sure the voltage of the power source when connect the equipment to the power outlet.
- The current of load and output power of loads shall be not over the specification.
- This equipment must be connected to the reliable earthling before using.



**Electric shock hazard inside the redundant power supply.**  
The exchange of modules shall be done by service person.

**This page is intentionally left blank.**