

USER'S MANUAL

eBOX630-528-FL Series

Embedded System

User's Manual



www.axiomtek.com

Disclaimers

This manual has been carefully checked and believed to contain accurate information. Axiomtek Co., Ltd. assumes no responsibility for any infringements of patents or any third party's rights, or any liability arising from such uses.

Axiomtek does not warrant or assume any legal liability or responsibility for the accuracy, completeness or usefulness of any information in this document. Axiomtek does not make any commitment to update any information in this manual.

Axiomtek reserves the right to change or revise this document and/or product at any time without notice.

No part of this document may be reproduced, stored in a retrieval system, or transmitted in any forms or by any means, electronic, mechanical, photocopying, recording, among others, without prior written permissions of Axiomtek Co., Ltd.

©Copyright 2023 Axiomtek Co., Ltd.

All Rights Reserved

March 2023, Version A5

Printed in Taiwan

Safety Precautions

Before getting started, please read the following important safety precautions.

1. The eBOX630-528-FL does not come with an operating system which must be loaded first before installation of any software into the computer.
2. Be sure to ground yourself to prevent static charge when installing any internal components. Use a wrist grounding strap and place all electronic components in any static-shielded devices. Most electronic components are sensitive to static electrical charge.
3. Disconnect the power cord from the eBOX630-528-FL prior to making any installation. Be sure both the system and all external devices are turned OFF. Sudden surge of power could ruin sensitive components. Make sure the eBOX630-528-FL is properly grounded.
4. Make sure the voltage of the power source is correct before connecting it to any power outlet.
5. Turn Off system power before cleaning. Clean the system using a cloth only. Do not spray any liquid cleaner directly onto the screen.
6. Do not leave equipment in an uncontrolled environment where the storage temperature is below -40°C or above 80°C as it may damage the equipment.
7. Do not open the system's back cover. If opening the cover for maintenance is a must, only a trained technician is allowed to do so. Integrated circuits on computer boards are sensitive to static electricity. To avoid damaging chips from electrostatic discharge, observe the following precautions:
 - Before handling a board or integrated circuit, touch an unpainted portion of the system unit chassis for a few seconds. This will help discharge any static electricity on the human body.
 - When handling boards and components, wear a wrist grounding strap available from most electronic component stores.
8. Caution:

Risk of explosion if battery is replaced by an incorrect type. Dispose of used batteries according to the instructions.

IL Y A RISQUE D'EXPLOSION SI LA BATTERIE EST
REPLACEE
PER UNE BATTERIE DE TYPE INCORRECT.
METTRE AU REBUT LES BATTERIES USAGEES
CONFORMEMENT AUX INSTRUCTIONS
9. Warning:

Hot Surface. Do Not Touch.

Restricted access locations: The equipment should only be installed in a Restricted Access Area.

Classifications

1. Degree of protection against electric shock: not classified
2. Degree of protection against ingress of water: IP40
3. Equipment not suitable for use in the presence of a flammable anesthetic mixture with air, oxygen or nitrous oxide.
4. Mode of operation: Continuous

General Cleaning Tips

Please keep the following precautions in mind while understanding the details fully before and during any cleaning of the computer and any components within.

A piece of dry cloth is ideal to clean the device.

1. Be cautious of any tiny removable components when using a vacuum cleaner to absorb dirt on the floor.
2. Turn the system off before cleaning up the computer or any components within.
3. Avoid dropping any components inside the computer or getting circuit board damp or wet.
4. For cleaning, be cautious of all kinds of cleaning solvents or chemicals which may cause allergy to certain individuals.
5. Keep foods, drinks or cigarettes away from the computer.

Cleaning Tools:

Although many companies have created products to help improve the process of cleaning computer and peripherals, users can also use house hold items accordingly for cleaning. Listed below are items available for cleaning computer or computer peripherals.

Pay special attention to components requiring designated products for cleaning as mentioned below.

- Cloth: A piece of cloth is the best tool to use when rubbing up a component. Although paper towels or tissues can be used on most hardware as well, it is recommended to use a piece of cloth.
- Water or rubbing alcohol: A piece of cloth may be somewhat moistened with water or rubbing alcohol before being rubbed on the computer. Unknown solvents may be harmful to plastic parts.
- Absorb dust, dirt, hair, cigarette and other particles outside of a computer can be one of the best methods of cleaning a computer. Over time these items may restrict the airflow in a computer and cause circuitry to corrode.
- Cotton swabs: Cotton swabs moistened with rubbing alcohol or water are applicable to reach areas in a keyboard, mouse and other areas.
- Foam swabs: If possible, it is better to use lint free swabs such as foam swabs.



【Note】 : *It is strongly recommended that customer should shut down the system before starting to clean any single components.*

Please follow the steps below:

1. Close all application programs;
2. Close operating software;
3. Turn off power switch;
4. Remove all devices;
5. Pull out power cable.

Scrap Computer Recycling

Please inform the nearest Axiomtek distributor as soon as possible for suitable solutions in case computers require maintenance or repair; or for recycling in case computers are out of order.

Trademarks Acknowledgments

Axiomtek is a trademark of Axiomtek Co., Ltd.

IBM, PC/AT, PS/2, VGA are trademarks of International Business Machines Corporation. Intel® and Pentium® are registered trademarks of Intel Corporation.

MS-DOS, Microsoft C and QuickBasic, Windows 10, Windows 8.1, Windows 8, Windows 7, Windows XPE, Windows XP, Windows CE embedded, Linux are trademarks of Microsoft Corporation.

Other brand names and trademarks are the properties and registered brands of their respective owners.

Table of Contents

Disclaimers.....	ii
Safety Precautions.....	iii
Classifications.....	iv
General Cleaning Tips	v
Scrap Computer Recycling.....	vi
SECTION 1 INTRODUCTION.....	1
1.1 General Descriptions	1
1.2 System Specifications	2
1.2.1 CPU	2
1.2.2 I/O System	2
1.2.3 System Specifications.....	4
1.2.4 Driver CD Contents.....	5
1.3 Dimensions	6
1.3.1 System Dimensions.....	6
1.3.2 Wall-mount Bracket Dimensions	7
1.3.3 DIN-Rail Bracket Dimensions	9
1.4 I/O Outlets.....	11
1.5 Packing List.....	13
1.6 Model List	13
SECTION 2 HARDWARE INSTALLATION	15
2.1 Installation of SO-DIMM.....	15
2.2 Installation of Mini PCIe Module (Full-Size).....	17
2.3 Installation of 2.5" SATA Device	19
2.4 Installation of SIM Card	20
SECTION 3 JUMPER & CONNECTOR SETTINGS.....	21
3.1 Locations of Jumpers & Connectors.....	21
3.2 Summary of Jumper Settings.....	23
3.2.1 Restore BIOS Optimal Defaults (JP1)	23
3.2.2 COM1 Data/Power Selection (JP3).....	24
3.2.3 COM2 Data/Power Selection (JP4).....	24
3.2.4 Auto Power On (SW1).....	24
3.3 Connectors	25
3.3.1 DC-in Phoenix Power Connector (CN20).....	26
3.3.2 HDMI Connector (CN14,CN15).....	26
3.3.3 Serial Port Connector (CN21,CN22).....	27
3.3.4 USB 2.0 Connector (USB1 , USB2)	27
3.3.5 USB 3.1 Connector (CN17,CN18)	28
3.3.6 Ethernet Connector (LAN1~LAN3)(CN16,CN19).....	29
3.3.7 VGA Connector (CN1)	30
3.3.8 ATX Power on/off (SW3).....	30
3.3.9 Reset Button (SW2)	30
3.3.10 Remote Power Switch Connector (PWRBT1)	31
3.3.11 AT/ATX Switch	31
3.3.12 Audio Connector	31
3.3.13 SIM Card Slot (CN4).....	32
3.3.14 8-CH Digital IO (CN5).....	32
3.3.15 SATA Connector (SATA 1 & 2).....	33

3.3.16	SATA Power Connector (CN12,CN13)	33
3.3.17	Full-Size PCI Express Mini Card Slot (CN6,CN7)	34
SECTION 4 BIOS SETUP UTILITY		37
4.1	Starting	37
4.2	Navigation Keys	37
4.3	Main Menu	38
4.4	Advanced Menu	39
4.5	Chipset Menu	56
4.6	Boot Menu	61
4.7	Save & Exit Menu	62
APPENDIX A WATCHDOG TIMER		65
	About Watchdog Timer	65
	Sample Program	66

SECTION 1 INTRODUCTION



This section contains general information and detailed specifications of the eBOX630-528-FL. Section 1 consist of the following sub-sections:

- General Descriptions
- System Specifications
- Dimensions
- I/O Outlets
- Packing List
- Model List

1.1 General Descriptions

The eBOX630-528-FL Series features 8th Gen Intel® Core™ i7/i5/i3 & Celeron® ULT processors (Whiskey Lake), high performance yet low power consumption, fanless slim type design, -40°C to +70°C extended operating temperature*, and 9V to 36V wide range DC power input with industrial-grade reliability. Highly integrated and with rich IO configuration, the eBOX630-528 is perfectly suitable for factory automation or any AIoT/Industry 4.0 applications.

Features

- 8th gen Intel® Core™ i7/i5/i3 & Celeron® ULT processors (Whiskey Lake-U)
- Dual channel DDR4 2400 SO-DIMM up to 64GB memory
- Supports 2 HDMI, VGA, 3 GbE LAN, 4 COM and 6 USB
- Fanless -40°C to +70°C* operating temperature
- 9 to 36 VDC wide range DC power input
- Trusted platform module (TPM 2.0 onboard)
- Hailo-8™ AI acceleration modules compatible**

* -40°C to +70°C operating temp. at 0.7 m/s air flow

** 0°C to +50°C operating temp. with Hailo-8™ AI acceleration module

Reliable and Stable Design

The embedded system supports 8th generation Intel® Core™ i7-8665UE/i5-8365UE/i3-8145UE & Celeron® 4305UE processors, along with the features of high performance, industrial-grade operation temperature/power input and multi-functional design that make it the best solution for smart factory/factory automation applications.

Rich IO Connectivity

The eBOX630-528-FL comes with rich I/O interfaces including two RS-232/422/485 ports, two RS-232, four USB 3.1 ports, two USB 2.0 ports, three GbE ports, two HDMI, one VGA, and one front access SIM slot socket supported.

Embedded O.S. Supported

The eBOX630-528-FL with 8th generation platform supports Windows® 10/11, Windows® 10/11 IoT and Linux.

High data security Supported

The eBOX630-528-FL is equipped with two swappable 2.5" SATA storage drive bays that can support RAID 0/1 for data backup.

1.2 System Specifications

1.2.1 CPU

- **CPU**

- Intel® Core™ i7-8665UE Processor
- Intel® Core™ i5-8365UE Processor
- Intel® Core™ i3-8145UE Processor
- Intel® Celeron® 4305UE Processor

- **Chipset**

- SoC

- **BIOS**

- American Megatrends Inc. UEFI (Unified Extensible Firmware Interface) BIOS.

- **System Memory**

- 2 x 260-pin DDR4-2400 SO-DIMM, up to 64GB

1.2.2 I/O System

- **Display**

- 2 x HDMI 1.4b (3840 x 2160 @ 30 Hz)
- 1 x VGA

- **Ethernet**

- 2 x 10/100/1000 Ethernet ports (i210-IT)
- 1 x 10/100/1000 Ethernet ports (i219-LM supports iAMT)

- **USB Ports**

- 2 x USB 3.1 Gen 2
- 2 x USB 3.1 Gen 1
- 2 x USB 2.0

- **Serial Ports**

- 2 x RS-232/422/485 (COM1~2)
- 2 x RS-232 (COM3~4)

- **DIO Port**

- 1 x 8-CH TTL DIO via DB9 female (4 in & 4 out)

- **Audio Port**

- 1 x MIC-in
- 1 x Line-out

- **Mini PCIe Interface**

- 2 x full-size PCI Express Mini Card slots
 - Slot A (USB + PCIe signal)
 - Slot B (USB + PCIe + SATA signal)

- **Storage**

- 2 x 2.5" swappable SATA HDD/SSD drive bays, up to 9.5mm in height (Software RAID 0,1)
- 1 x mSATA (enabled in BIOS setting, (Software RAID 0,1))

- **Indicator**

- 1 x Green LED as indicator for PWR status
- 1 x Orange LED as indicator for HDD/SSD active

- **Switch**

- 1 x ATX PWR switch
- 1 x Remote PWR switch
- 1 x AT/ATX Quick switch
- 1 x Reset switch connector

- **Antenna & SIM**
 - 4 x SMA type connector openings for antenna
 - 1 x external access SIM slot

- **TPM 2.0**
 - 1 x ST33HTPH2E32AHB4

1.2.3 System Specifications

- **Watchdog Timer**
 - 1-255 seconds or minutes; up to 255 levels.

- **Power Supply**
 - 9V-36V DC input

- **Operation Temperature**
 - -40°C to +65°C (-40°F to +149°F) with 0.5 m/s air flow at 9-36V DC Mode (with W.T. DRAM & SSD,CPU TDP 15W)
 - -40°C to +70°C (-40°F to +158°F) with 0.7 m/s air flow at 9-36V DC Mode (with W.T. DRAM & SSD,CPU TDP 15W)

- **Storage Temperature**
 - -40°C ~+80°C (-40 °F ~ 176°F)

- **Humidity**
 - 10% ~ 95% (non-condensation)

- **Shock**
 - IEC 60068-2-27 (w/SSD: 50G, half sine,11 ms duration)

- **Vibration Endurance**
 - IEC 60068-2-64 (w/SSD: 3Grms STD, random, 5 - 500 Hz,1 hr/axis)

- **Weight**
 - 2.2 kg (4.85 lb) without package
 - 3.0 kg (6.6 lb) with package

- **Dimension**
 - 250mm (9.84") (W) x 170mm (6.69") (D) x 60mm (2.36") (H)

1.2.4 Driver CD Contents

Please download the following eBOX630-528-FL drivers from the Axiomtek official website.

- Ethernet
- Chipset
- Graphic
- Serial Port
- USB 3.1
- Intel® ME
- Intel® Rapid Storage Technology



【Note】 : *All specifications and images are subject to change without notice.*

1.3 Dimensions

The following diagrams show dimensions and outlines of the eBOX630-528-FL.

1.3.1 System Dimensions

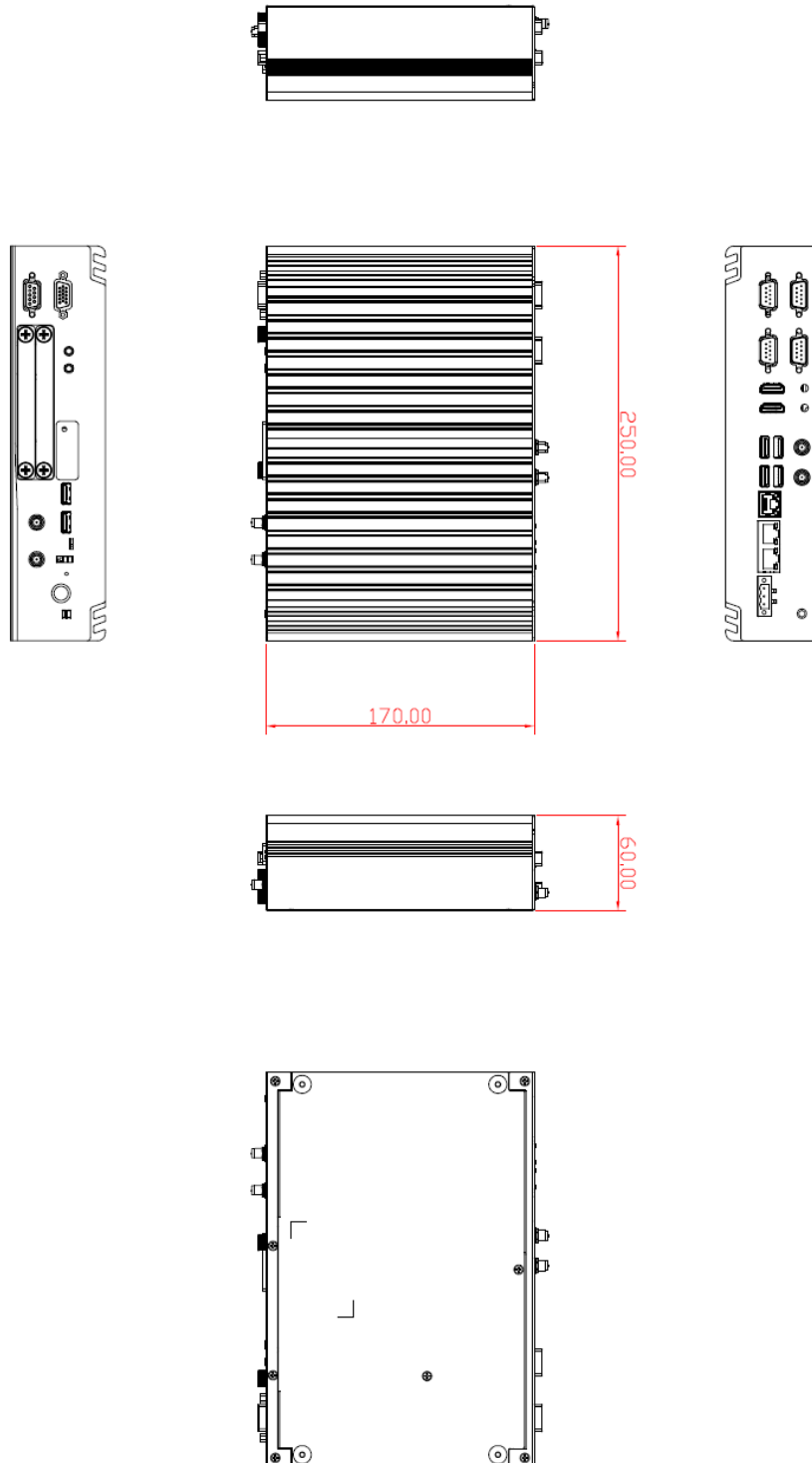

1.3.2 Wall-mount Bracket Dimensions

From the accessories box, users can get 4pcs of truss head M3*6L screws for fixing the wall mount kit.

Note: When users install the wall mount kit, please turn the LAN ports side outlet towards the floor.

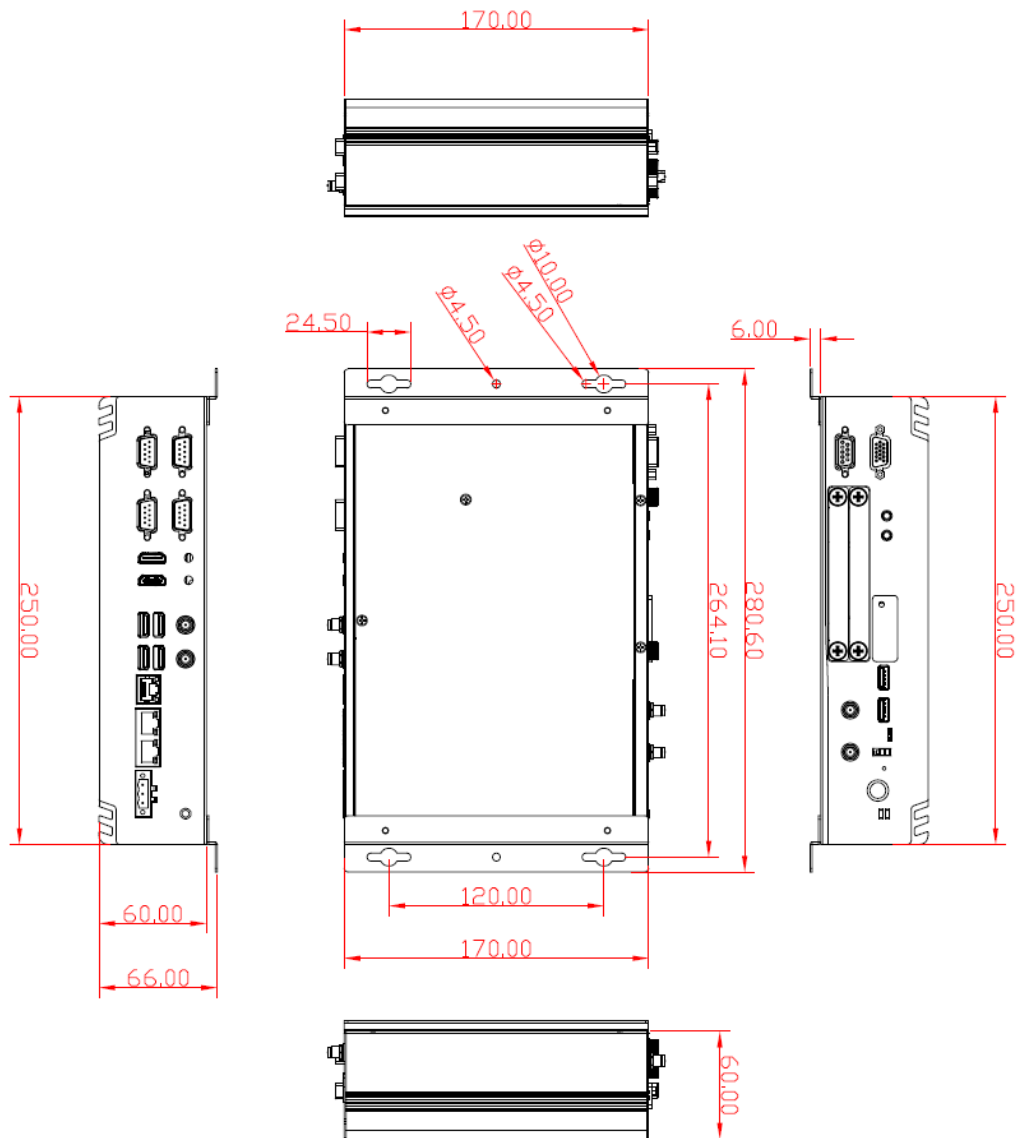

Wall-mount Bracket Assembly Drawing

From the accessories box, users can get 4pcs of truss head M3*6L screws for fixing the wall mount kit.

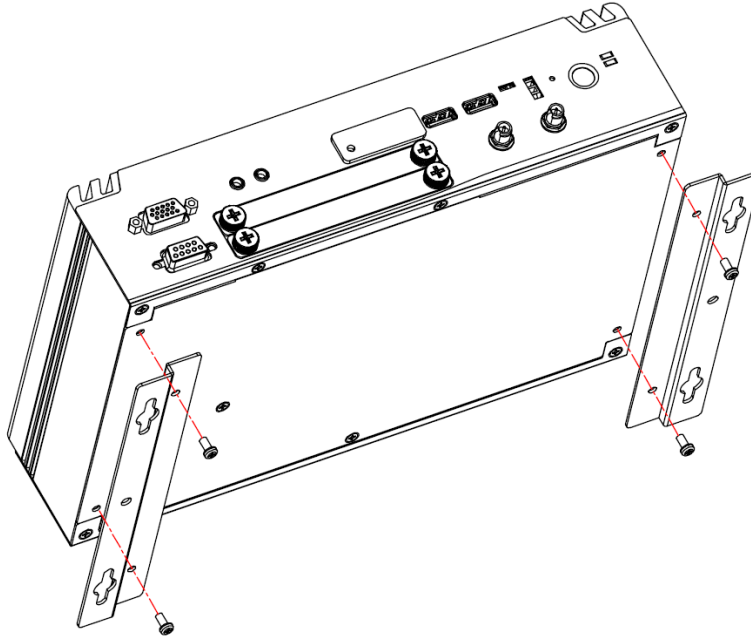

Note : If users install the screws in drywall, use the hollow wall anchors to ensure that the unit does not pull away from the wall due to prolonged strain between the cable and the power connector.

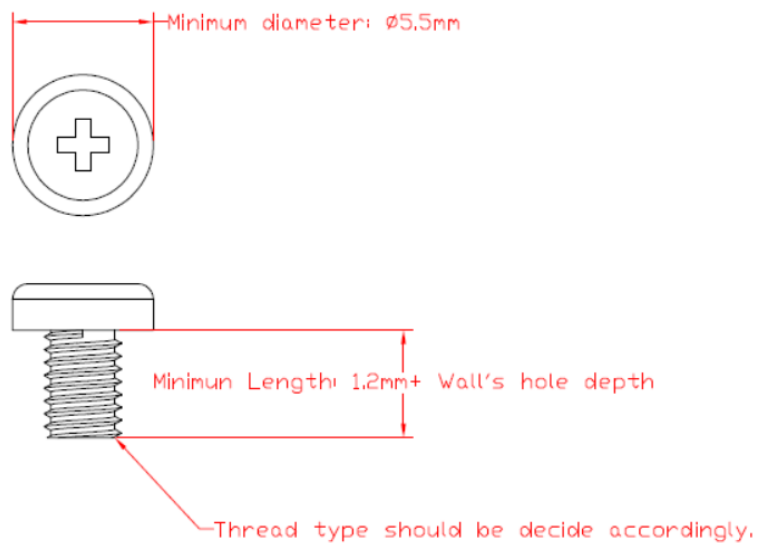

1.3.3 DIN-Rail Bracket Dimensions

From the accessories box, users can get 4pcs of truss head M3*6L and 6pcs of M3*4L countersunk flat head screws for fixing the DIN-rail mount kit.

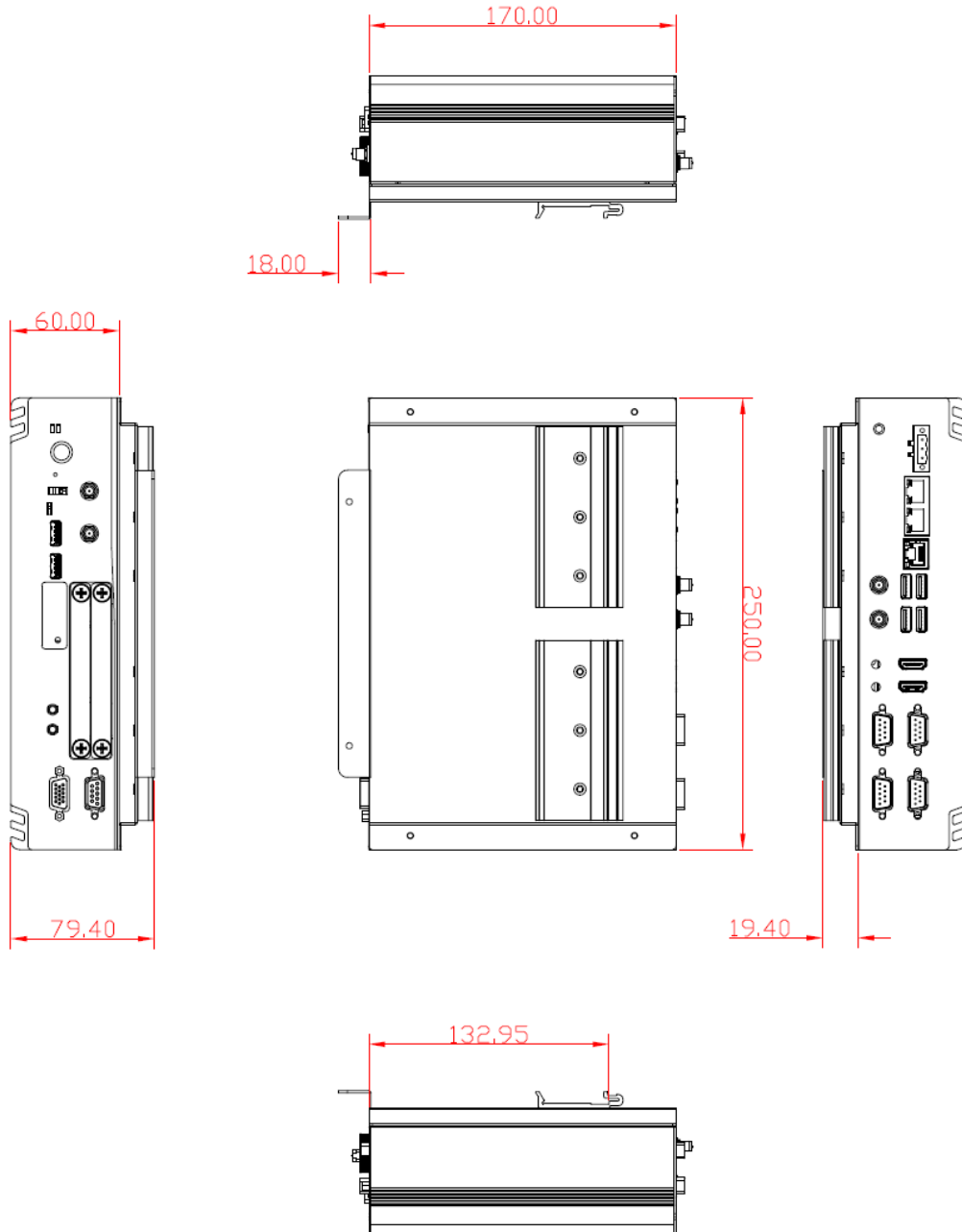

DIN-Rail Bracket Assembly Drawing

From the accessory box, users can get 6pcs of truss head M3*6L screws for fixing the wall mount kit.

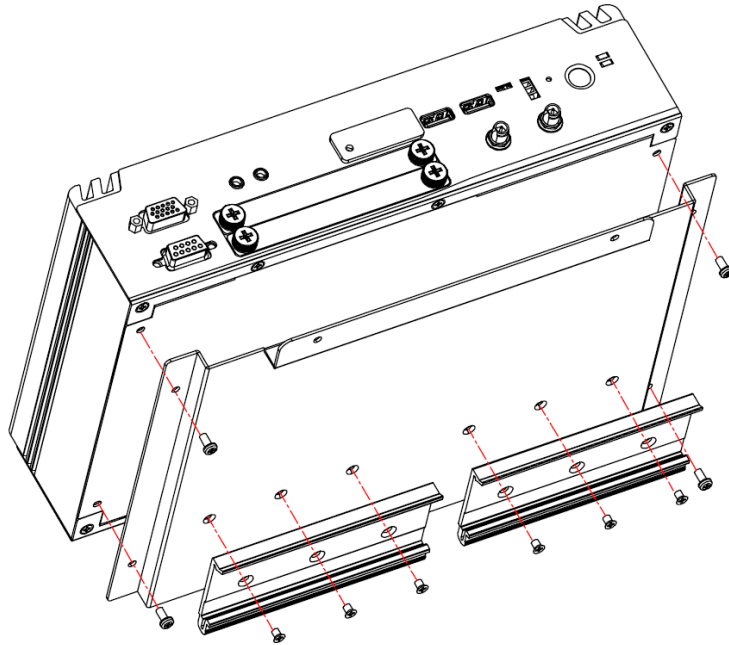

1.4 I/O Outlets

The following figures show I/O outlets on the eBOX630-528-FL.

Front View

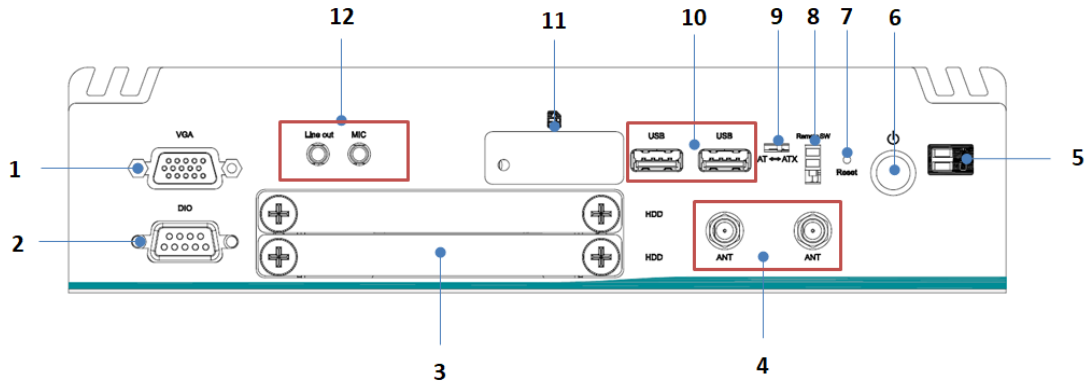

1	1 x VGA	7	1 x Reset switch connector
2	1 x 8-CH DIO (DB9 female,4IN & 4OUT)	8	1 x Remote power switch
3	2 x Swappable HDD drive bay	9	1 x AT/ATX quick switch
4	2 x Antenna opening	10	2 x USB 2.0
5	LEDs	11	1 x Front access SIM slot
6	1 x Power switch	12	1 x Audio (Mic in/Line out)

Rear View

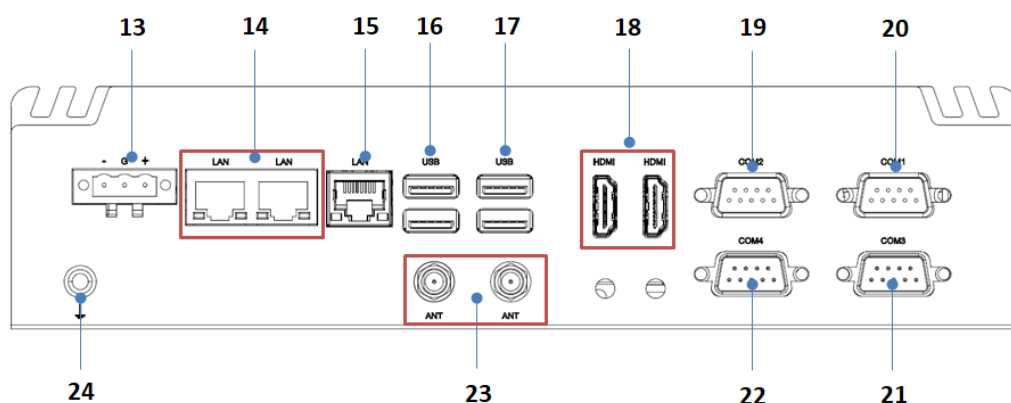

13	1 x Phoenix type power input	19	1 x COM 2 (RS232/422/485)
14	2 x LAN (i210-IT)	20	1 x COM 1 (RS232/422/485)
15	1 x LAN (i219-LM)	21	1 x COM 3 (RS232)
16	2 x USB 3.1 gen 1	22	1 x COM 4 (RS232)
17	2 x USB 3.1 gen 2	23	2 x Antenna opening
18	2 x HDMI	24	1 x Grounding screw

1.5 Packing List

The eBOX630-528-FL comes with the following bundle package:

- eBOX630-528-FL system unit x 1
- DRAM thermal pad x 2
- DRAM bracket x 1
- Remote switch cable x 1
- 3-pin phoenix connector x 1
- Foot pad x 4
- Screw pack x 1

1.6 Model List

eBOX630-528-FL-8665UE	Fanless embedded system with Intel® i7-8665UE, 2 HDMI, 1 VGA, 3 GbE LAN, 6 USB and 9 to 36 VDC
eBOX630-528-FL-8365UE	Fanless embedded system with Intel® i5-8365UE, 2 HDMI, 1 VGA, 3 GbE LAN, 6 USB and 9 to 36 VDC
eBOX630-528-FL-8145UE	Fanless embedded system with Intel® i3-8145UE, 2 HDMI, 1 VGA, 3 GbE LAN, 6 USB and 9 to 36 VDC
eBOX630-528-FL-4305UE	Fanless embedded system with Intel® Celeron 4305UE, 2 HDMI, 1 VGA, 3 GbE LAN, 6 USB and 9 to 36 VDC

Please contact Axiomtek's distributors immediately in case any abovementioned items are missing.

This page is intentionally left blank.

SECTION 2 HARDWARE INSTALLATION

The eBOX630-528-FL is convenient for various hardware configurations, such as CPU, DRAM, HDD (Hard Disk Drive), SSD (Solid State Drive), PCI Express Mini card modules and optional MXM graphic module. Section 2 contains guidelines for hardware installation.

2.1 Installation of SO-DIMM

- Step 1** Turn off the system and unplug the power cord.
- Step 2** Turn the system unit upside down and loosen two screws on the bottom cover of the chassis and pull up the bottom cover.

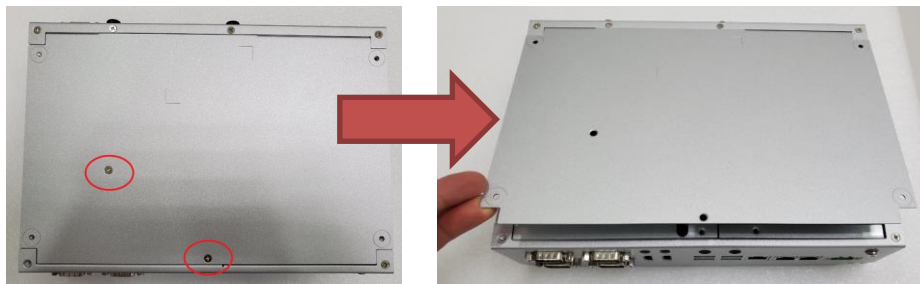

- Step 3** Pull and open the bottom cover back, then located the dual DDR4 SO-DIMM sockets on main board as red marked.

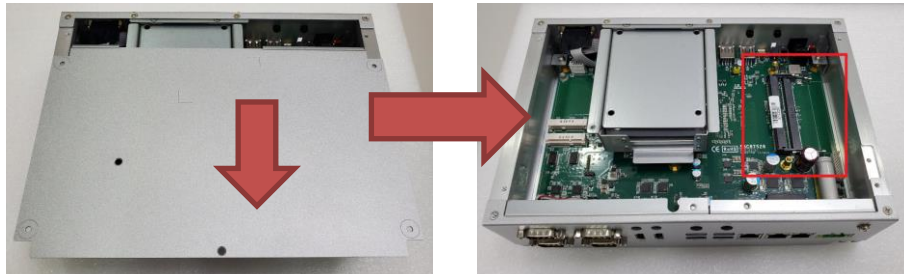

- Step 4** Locate the memory module, insert a gold colored contact into the socket and push the module down until it is locked in place by the two end latches. And take out the DRAM thermal pad and bracket from accessories pack.

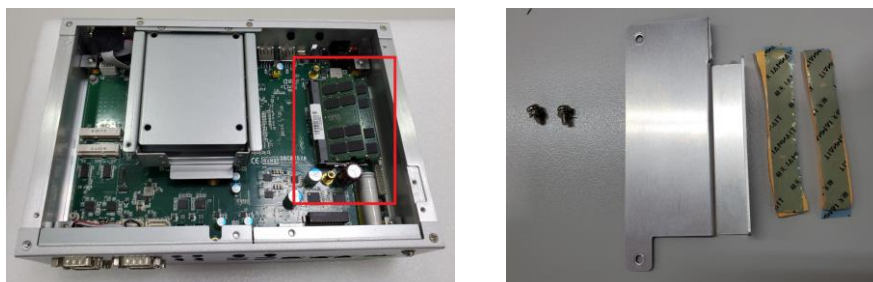

Step 5 Please place the DRAM thermal pad on the module and screw the bracket.



Step 6 Put the bottom cover back and fasten two screws back onto the system.

2.2 Installation of Mini PCIe Module (Full-Size)

Step 1 Turn off the system and unplug the power cord.

Step 2 Turn the system upside down to locate screws at the bottom, and loosen two screws as red marked.

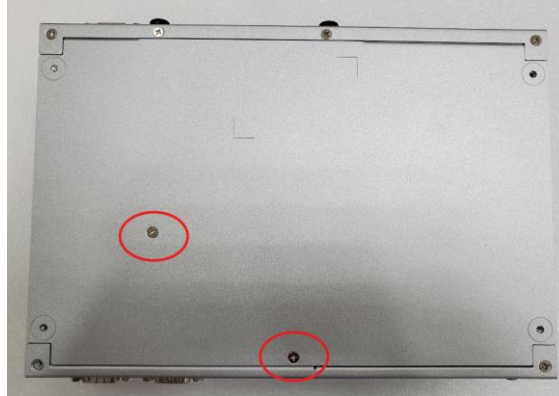

Step 3 The eBOX630-528 has two mini card slots:

Slot A (CN6) (USB + PCIe signal)

Slot B (CN7) (USB + PCIe + SATA signal)



Step 4 Slot A is used as the wireless mini card slot, insert the WiFi or LTE mini PCIe module into the slot and fasten the screw.

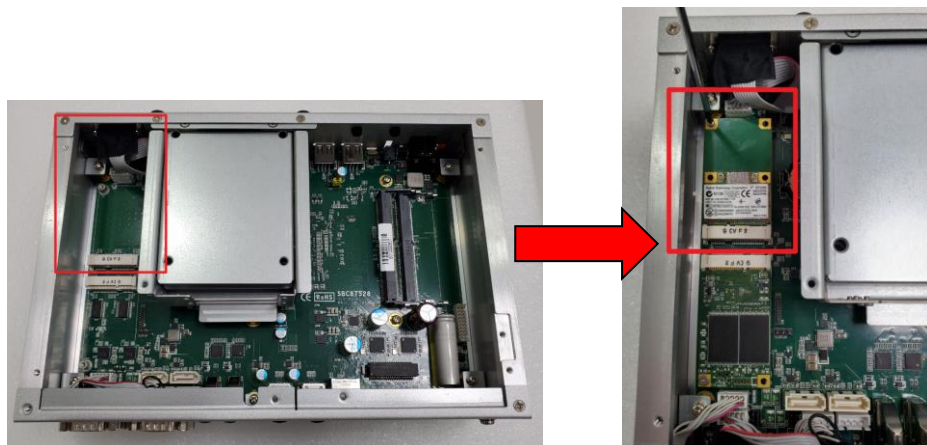

Step 5 And then connect the cable to antenna opening.

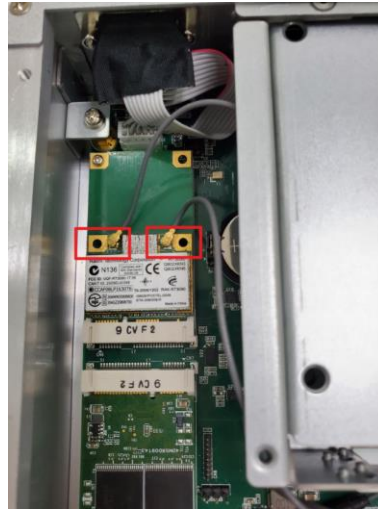

Step 6 Put the bottom cover and fasten all screws back onto the system.

2.3 Installation of 2.5" SATA Device

Step 1 Turn off the system and unplug the power cord.

Step 2 Loosen two of the SATA drive tray's screws and pull out the SATA HDD drive tray.

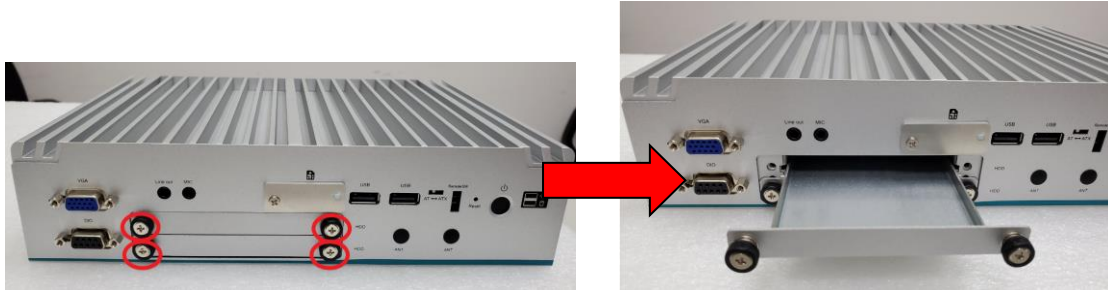

Step 3 Turn the SATA drive tray upside down to install SSD/HDD and then fasten the four HDD screws to secure the SATA drive tray.

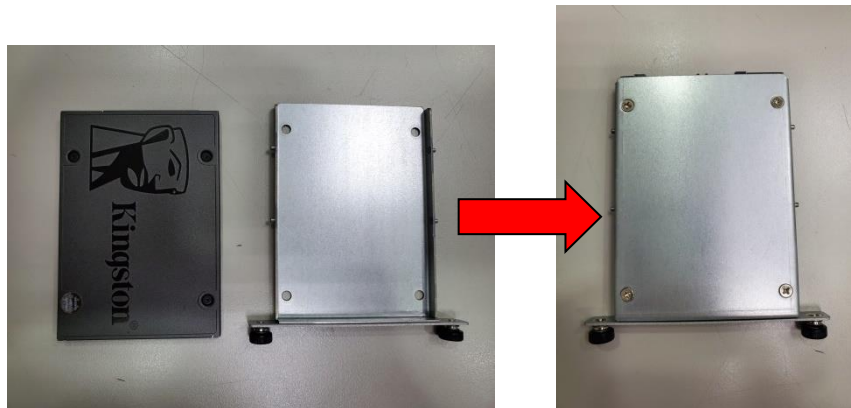

Step 4 Slide the SATA drive tray back into the system and fasten the screws firmly to complete the installation.



2.4 Installation of SIM Card

Step 1 Turn off the system and unplug the power cord.

Step 2 Loosen the screw of the SIM slot cover on chassis.

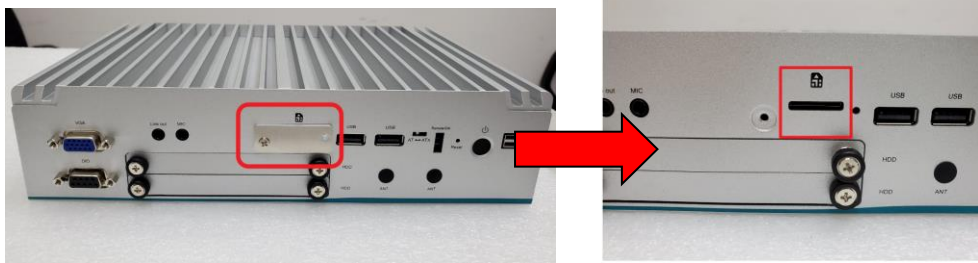

Step 3 Make sure the SIM card direction is correct and insert the SIM card firmly.



SIM card direction (contact side facing upward)

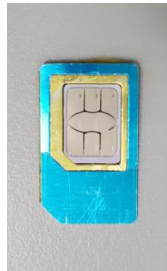

SECTION 3 JUMPER & CONNECTOR SETTINGS

Proper jumper settings configure the eBOX630-528-FL to meet various application needs. Hereby all jumpers settings along with their default settings are listed for devices onboard.

3.1 Locations of Jumpers & Connectors

SBC87528 Top View

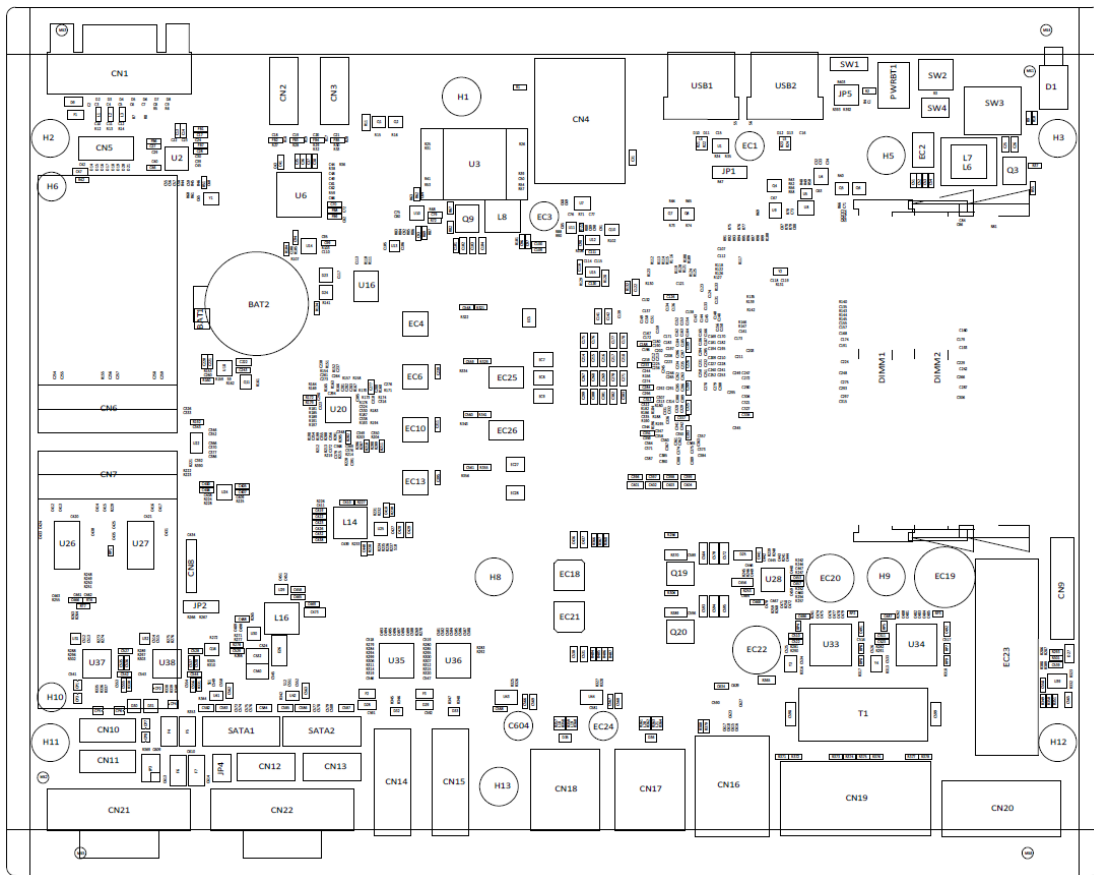

SBC87528 Bottom View

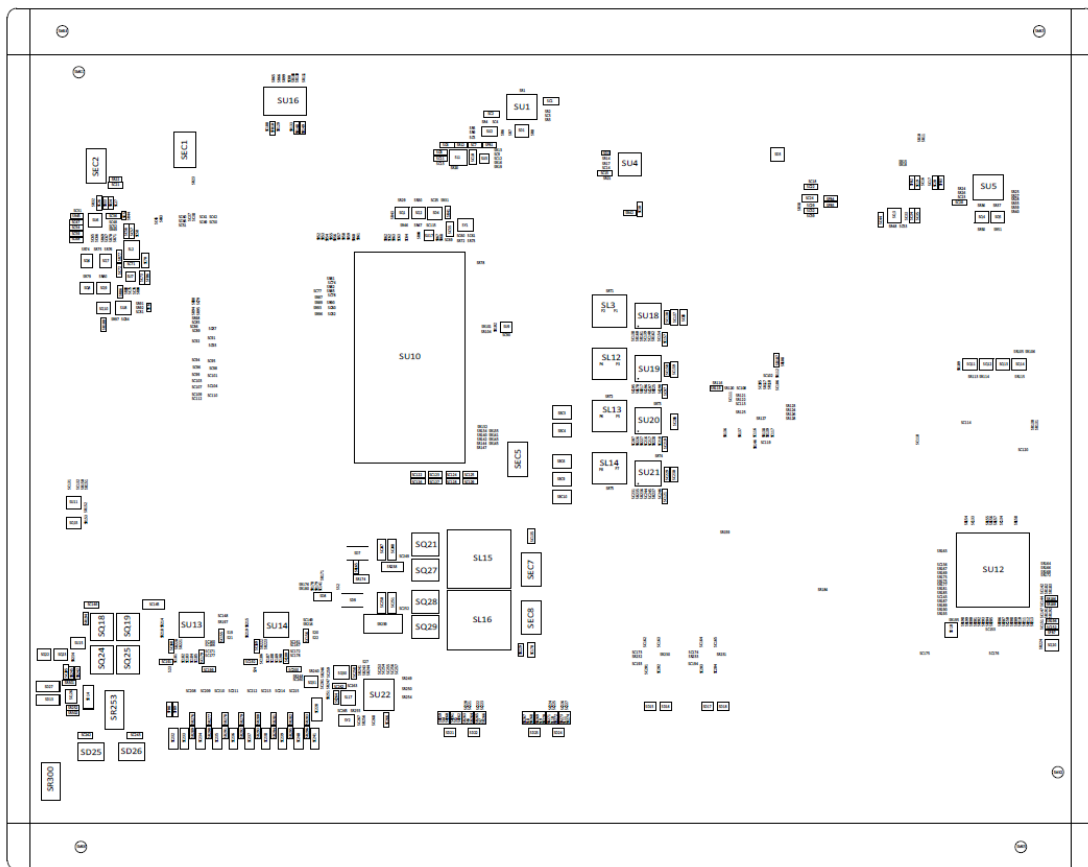

 **【Note】** : *It is strongly recommended that any unmentioned jumper settings should not be modified without instructions by Axiomtek FAEs. Any modifications without instructions might cause system failure.*

3.2 Summary of Jumper Settings

Proper jumper settings configure the eBOX630-528-FL to meet various application purposes. A table of all jumpers and their default settings is listed below.

Jumpers	Descriptions		Settings
JP1	Restore BIOS Optimal Defaults Default: Normal Operation		Short 1-2
JP3	COM1 Data/Power Selection Default: RS-232 Data	CN21 Pin 1: DCD	3-5 Close
		CN21 Pin 9: RI	4-6 Close
JP4	COM2 Data/Power Selection Default: RS-232 Data	CN22 Pin 1: DCD	3-5 Close
		CN22 Pin 9: RI	4-6 Close



【Note】 : How to setup jumpers

Illustrations below show that a cap on a jumper is to “close” the jumper, whereas that off a jumper is to “open” the jumper.



[Open]



[Closed]



[Pin1-2 Closed]

3.2.1 Restore BIOS Optimal Defaults (JP1)

Put the jumper clip to pin 2-3 for a few seconds then move it back to pin 1-2. This procedure is to restore BIOS optimal defaults.

Functions	Settings
Normal (Default)	1-2
Clear RTC	2-3



3.2.2 COM1 Data/Power Selection (JP3)

This is a 2x3-pin (pitch=2.0mm) jumper. The COM1 port has +5V level power capability on DCD and +12V level on RI by setting jumper JP3.

Functions	Settings
Power: Set CN21 pin 1 to +5V level	1-3 close
Data: Set CN21 pin 1 to DCD (Default)	3-5 close
Power: Set CN21 pin 9 to +12V level	2-4 close
Data: Set CN21 pin 9 to RI (Default)	4-6 close

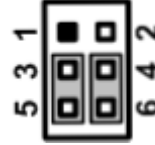

3.2.3 COM2 Data/Power Selection (JP4)

This is a 2x3-pin (pitch=2.0mm) jumper. The COM2 port has +5V level power capability on DCD and +12V level on RI by setting jumper JP4.

Functions	Settings
Power: Set CN22 pin 1 to +5V level	1-3 close
Data: Set CN22 pin 1 to DCD (Default)	3-5 close
Power: Set CN22 pin 9 to +12V level	2-4 close
Data: Set CN22 pin 9 to RI (Default)	4-6 close

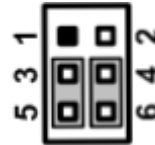

3.2.4 Auto Power On (SW1)

If SW1 is enabled for power input, the system will be automatically powered on without pressing the soft power button. If SW1 is disabled for power input, it is necessary to manually press the soft power button to power on the system.

Functions	Settings
Disable auto power on (Default)	1-2 close
Enable auto power on	2-3 close

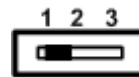

3.3 Connectors

Please refer to the below connector table to get information on pin assignments for individual connectors.

External Connectors	Sections
DC-in Phoenix Power Connector	3.3.1
HDMI Connector	3.3.2
Serial Port Connector	3.3.3
USB 2.0 Connector	3.3.4
USB 3.1 Connector	3.3.5
Ethernet Connector	3.3.6
VGA Connector	3.3.7
ATX Power On/Off Button	3.3.8
Reset Button	3.3.9
Remote Power Switch Connector	3.3.10
AT/ATX Quick Switch	3.3.11
Audio Connector	3.3.12
SIM Connector	3.3.13
8-CH Digital IO	3.3.14
Internal Connectors	Sections
SATA Signal Connector	3.3.15
SATA Power Connector	3.3.16
Full-Size Express Mini Card Slot	3.3.17

3.3.1 DC-in Phoenix Power Connector (CN20)

The system supports 24V Phoenix DC-in connector for system power input.

Pins	Signals
1	DC+
2	GND
3	DC-

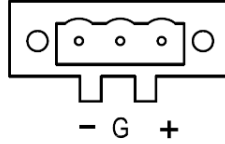

3.3.2 HDMI Connector (CN14,CN15)

The HDMI (High-Definition Multimedia Interface) is a compact digital interface which is capable of transmitting high-definition video and high-resolution audio over a single cable.

Pins	Signals	Pins	Signals
1	HDMI OUT_DATA2+	11	GND
2	GND	12	HDMI OUT Clock-
3	HDMI OUT_DATA2-	13	N.C.
4	HDMI OUT_DATA1+	14	N.C.
5	GND	15	HDMI OUT_SCL
6	HDMI OUT_DATA1-	16	HDMI OUT_SDA
7	HDMI OUT_DATA0+	17	GND
8	GND	18	+5V
9	HDMI OUT_DATA0-	19	HDMI_HTPLG
10	HDMI OUT Clock+		

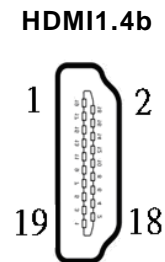

3.3.3 Serial Port Connector (CN21,CN22)

The system has two serial ports. COM1~COM2 are RS-232/422/485 ports. Please refer to Chapter 4 for the details of BIOS settings. COM1 and COM2 is equipped with +5V level power capability on DCD and +12V level on RI by setting JP3 and JP4 (see section 2.3.2 and 2.3.3).

※COM1~2 (CN21,CN22)

Pins	RS-232	RS-422	RS-485
1	DCD, Data Carrier Detect	TX-	Data-
2	RXD, Receive Data	TX+	Data+
3	TXD, Transmit Data	RX+	No use
4	DTR, Data Terminal Ready	RX-	No use
5	GND, Ground	No use	No use
6	DSR, Data Set Ready	No use	No use
7	RTS, Request To Send	No use	No use
8	CTS, Clear To Send	No use	No use
9	RI, Ring Indicator	No use	No use

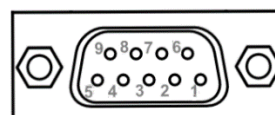

3.3.4 USB 2.0 Connector (USB1 , USB2)

The Universal Serial Bus connectors are compliant with USB 2.0 (480Mbps) and ideal for installing USB peripherals such as a keyboard, mouse, scanner, etc...

Pins	Signal USB Port 0	Pins	Signal USB Port 1
1	USB_VCC (+5V level standby power)	3	USB_Data+
2	USB_Data-	4	GND



3.3.5 USB 3.1 Connector (CN17,CN18)

The system has six USB ports: two ports compliant with USB 3.1 gen2 (10GB/s) , two ports compliant with USB 3.1 gen1 (5GB/s), and are ideal for installing USB peripherals such as scanners, cameras and USB devices, etc.

Pins	Signal USB Port 0	Pins	Signal USB Port 1
1	USB_VCC (+5V level standby power)	10	USB_VCC (+5V level standby power)
2	USB_Data-	11	USB_Data-
3	USB_Data+	12	USB_Data+
4	GND	13	GND
5	SSRX-	14	SSRX-
6	SSRX+	15	SSRX+
7	GND	16	GND
8	SSTX-	17	SSTX-
9	SSTX+	18	SSTX+

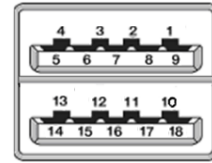

- ※ **CN17 : USB3.1 gen1**
- ※ **CN18 : USB3.1 gen2**

3.3.6 Ethernet Connector (LAN1~LAN3)(CN16,CN19)

The board has three RJ-45 connectors. LAN1 is designed by Intel i219LM and LAN2 to LAN3 are Intel i210-IT.

Pins	LAN Signal	Pins	LAN Signal
L1	MDI0+	L5	MDI2+
L2	MDI0-	L6	MDI2-
L3	MDI1+	L7	MDI3+
L4	MDI1-	L8	MDI3-
A	Activity link LED(Yellow) OFF: No link Blinking: Link established; data activity detected		
B	Speed LED OFF: 10Mbps data rate Green: 100Mbps data rate Orange: 1GMbps data rate		

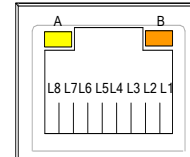

3.3.7 VGA Connector (CN1)

This is a standard 15-pin D-Sub connector. It is commonly used for VGA display. This VGA interface configuration can be configured via software utility.

Pin	Signal	Pin	Signal
1	RED	2	GREEN
3	BLUE	4	N.C
5	GND	6	GND
7	GND	8	GND
9	CRT_VCC	10	GND
11	N.C	12	DDC_DATA
13	Hsync	14	Vsync
15	DDC_CLK		

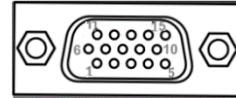

3.3.8 ATX Power on/off (SW3)

The ATX power button is on the I/O side. It can allow users to control eBOX630-528 power on/off.

Functions	Descriptions
On	Turn on/off system
Off	Keep system status



3.3.9 Reset Button (SW2)

The Reset button can allow users to reset the eBOX630-528-FL system.

Functions	Descriptions
On	Reset system
Off	Keep system status



3.3.10 Remote Power Switch Connector (PWRBT1)

One 2-pin connector output for remote power on/off switch.

* Connector specification: Male / Female: BTX 2P 3.0mm

Functions	Descriptions
Short (1-2)	Turn on/off system
Open	Keep system status

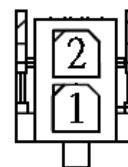

3.3.11 AT/ATX Switch

If you set AT/ATX switch to AT mode, the system will automatically power on without the need to press the soft power button during power input; users can use this switch to achieve auto power on demand.

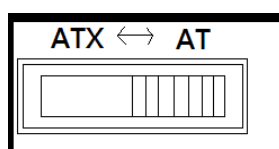

3.3.12 Audio Connector

These two audio jacks ideal are for Audio Mic-In and Audio Line-out.

Pin	Signal
1	Line Out
2	Microphone In

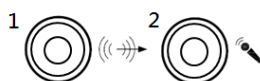

3.3.13 SIM Card Slot (CN4)

The eBOX630-528 includes one SIM slot on the front panel of the system for inserting a SIM card. It is mainly used in 3G/LTE wireless network application on CN4.

Pins	Signals
1	PWR
2	RST
3	CLK
4	NC
5	GND
6	VPP
7	I/O
8	NC

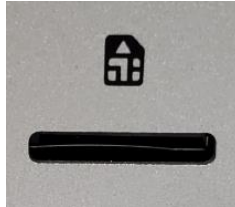

3.3.14 8-CH Digital IO (CN5)

eBOX630-528 supports one 8-CH output connector (DIO1~8) , default : 4IN & 4OUT. Each bit can be set to function as input or output by software programming, and users can set up via BIOS setting.

Pin	Description
1	DIO1
2	DIO2
3	DIO3
4	DIO4
5	DIO5
6	DIO6
7	DIO7
8	DIO8
9	GND

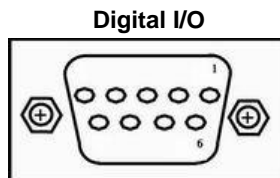

3.3.15 SATA Connector (SATA 1 & 2)

These Serial Advanced Technology Attachment (Serial ATA or SATA) connectors are used for high-speed SATA interfaces. They are computer bus interfaces for connecting to devices such as hard disk drives. This board has two SATA 3.0 ports with 6Gb/s performance.

Pins	Signals
1	GND
2	SATA_TX+
3	SATA_TX-
4	GND
5	SATA_RX-
6	SATA_RX+
7	GND

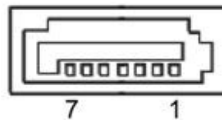

3.3.16 SATA Power Connector (CN12,CN13)

Based on CN12、CN13 to offer the SATA power for SATA 2.5" HDD/SSD.

*connector specification: wafer 4P, P=2.5mm

Pins	Signals
1	+12V level
2	GND
3	GND
4	+5V level

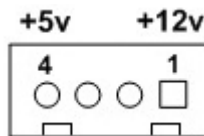

3.3.17 Full-Size PCI Express Mini Card Slot (CN6,CN7)

The eBOX630-528-FL supports dual full-size PCI-Express Mini Card slots. CN6 is applying to either PCI-Express or USB 2.0 signal, and complies with PCI-Express Mini Card Spec. V1.2.

CN7 is applying to PCI-Express or SATA (mSATA) (via BIOS selection) and USB signals; PCI-Express complies with PCI-Express Mini Card Spec. V1.2. Thus, users can install mSATA or WLAN/WWAN cards into this slot. Please refer to the BIOS setting for SATA configuration to enable or disable mSATA support.

CN6

Pins	Signals	Pins	Signals
1	WAKE#	2	+3.3VSB
3	No use	4	GND
5	No use	6	+1.5V
7	CLKREQ#	8	No use
9	GND	10	No use
11	REFCLK-	12	No use
13	REFCLK+	14	No use
15	GND	16	No use
17	No use	18	GND
19	No use	20	W_DISABLE#
21	GND	22	PERST#
23	PE_RXN3/	24	+3.3VSB
25	PE_RXP3/	26	GND
27	GND	28	+1.5V
29	GND	30	SMB_CLK
31	PE_TXN3/	32	SMB_DATA
33	PE_TXP3/	34	GND
35	GND	36	USB_D8-
37	GND	38	USB_D8+
39	+3.3VSB	40	GND
41	+3.3VSB	42	No use
43	GND	44	No use
45	No use	46	No use
47	No use	48	+1.5V
49	No use	50	GND
51	No use	52	+3.3VSB

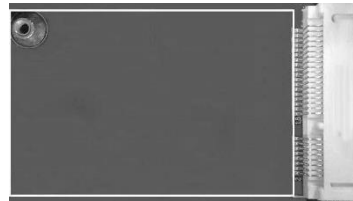
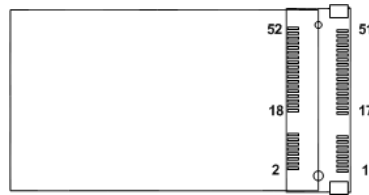

CN7

Pins	Signals	Pin	Signals
1	WAKE#	2	+3.3VSB
3	No use	4	GND
5	No use	6	+1.5V
7	CLKREQ#	8	No use
9	GND	10	No use
11	REFCLK-	12	No use
13	REFCLK+	14	No use
15	GND	16	No use
17	No use	18	GND
19	No use	20	W_DISABLE#
21	GND	22	PERST#
23	PE_RXN3/mSATA	24	+3.3VSB
25	PE_RXP3/mSATA	26	GND
27	GND	28	+1.5V
29	GND	30	SMB_CLK
31	PE_TXN3/ mSATA	32	SMB_DATA
33	PE_TXP3/ mSATA	34	GND
35	GND	36	USB_D8-
37	GND	38	USB_D8+
39	+3.3VSB	40	GND
41	+3.3VSB	42	No use
43	GND	44	No use
45	No use	46	No use
47	No use	48	+1.5V
49	No use	50	GND
51	No use	52	+3.3VSB

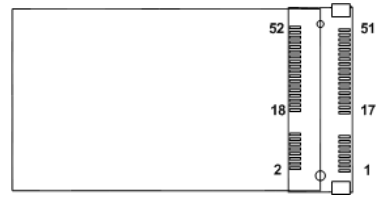

This page is intentionally left blank.

SECTION 4

BIOS SETUP UTILITY

This section provides users with detailed descriptions in terms of how to set up basic system configurations through the BIOS setup utility.

4.1 Starting

To enter the setup screens, follow the steps below:

1. Turn on the computer and press the key immediately.
2. After pressing the key, the main BIOS setup menu displays. Users can access other setup screens, such as the Advanced and Chipset menus, from the main BIOS setup menu.

It is strongly recommended that users should avoid changing the chipset's defaults. Both AMI and system manufacturer have carefully set up these defaults that provide the best performance and reliability.

4.2 Navigation Keys

The BIOS setup/utility uses a key-based navigation system called hot keys. Most of the BIOS setup utility hot keys can be used at any time during the setup navigation process. These keys include <F1>, <F2>, <Enter>, <ESC>, <Arrow> keys, and so on.



【Note】 : *Some of the navigation keys differ from one screen to another.*

Hot Keys	Descriptions
→← Left/Right	The Left and Right <Arrow> keys allow users to select a setup screen.
↑↓ Up/Down	The Up and Down <Arrow> keys allow users to select a setup screen or sub-screen.
+– Plus/Minus	The Plus and Minus <Arrow> keys allow users to change the field value of a particular setup item.
Tab	The <Tab> key allows users to select setup fields.
F1	The <F1> key allows users to display the General Help screen.
F2	The <F2> key allows users to Load Previous Values.
F3	The <F3> key allows users to Load Optimized Defaults.
F4	The <F4> key allows users to save any changes they made and exit the Setup. Press the <F4> key to save any changes.
Esc	The <Esc> key allows users to discard any changes they made and exit the Setup. Press the <Esc> key to exit the setup without saving any changes.
Enter	The <Enter> key allows users to display or change the setup option listed for a particular setup item. The <Enter> key can also allow users to display the setup sub- screens.

4.3 Main Menu

The Main Menu screen is the first screen users see when entering the setup utility. Users can always return to the Main setup screen by selecting the Main tab. System Time/Date can be set up as described below. The Main BIOS setup screen is also shown below.



BIOS Information

Display the auto-detected BIOS information.

System Date/Time

Use this option to change the system time and date. Highlight System Time or System Date using the <Arrow> keys. Enter new values through the keyboard. Press the <Tab> key or the <Arrow> keys to move between fields. The date must be entered in MM/DD/YY format. The time is entered in HH:MM:SS format.

Access Level

Display the access level of current user.

4.4 Advanced Menu

The Advanced menu also allows users to set configuration of the CPU and other system devices. Users can select any items in the left frame of the screen to go to sub menus:

- ▶ Super IO Configuration
- ▶ HW Monitor
- ▶ ACPI Settings
- ▶ Trusted Computing
- ▶ CPU Configurations
- ▶ SATA & RST Configuration
- ▶ PCH-FW Configuration
- ▶ AMT Configuration
- ▶ USB Configuration
- ▶ S5 RTC Wake Setting
- ▶ Device Configuration

For items marked with “▶”, please press <Enter> for more options.

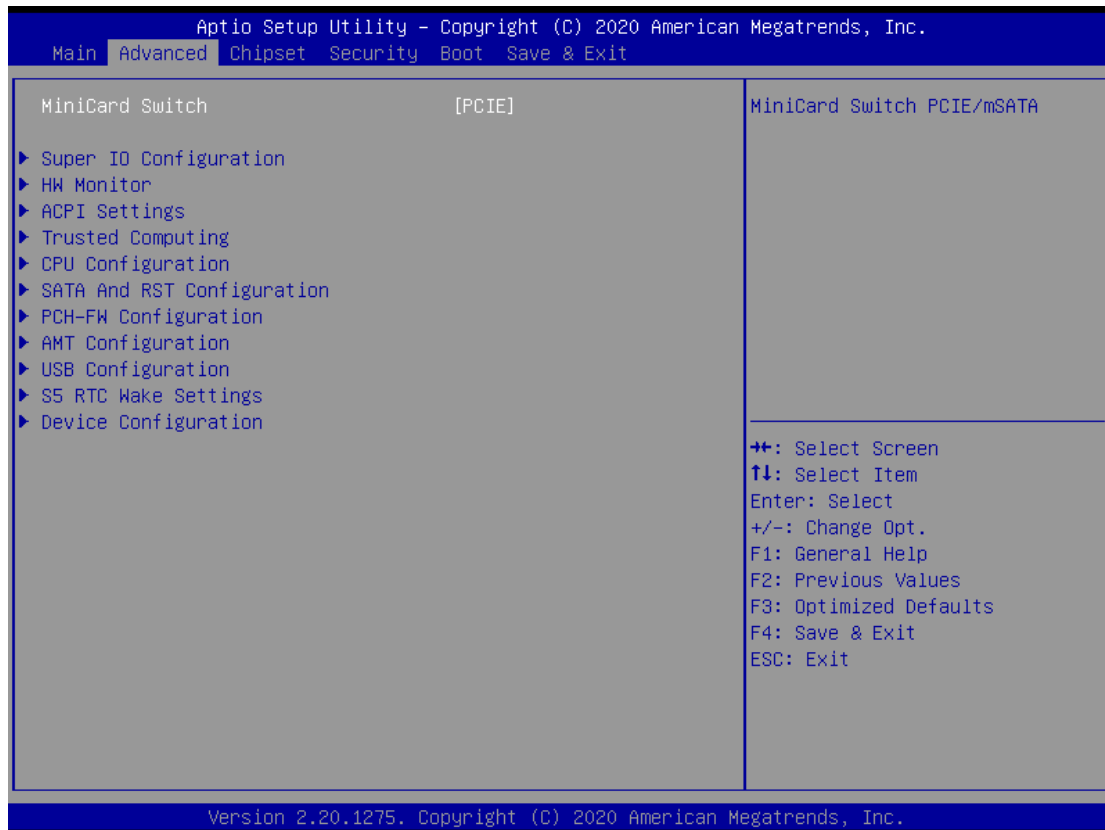

Mini Card switch

Use this to select Mini Card setting; default is "PCIE".

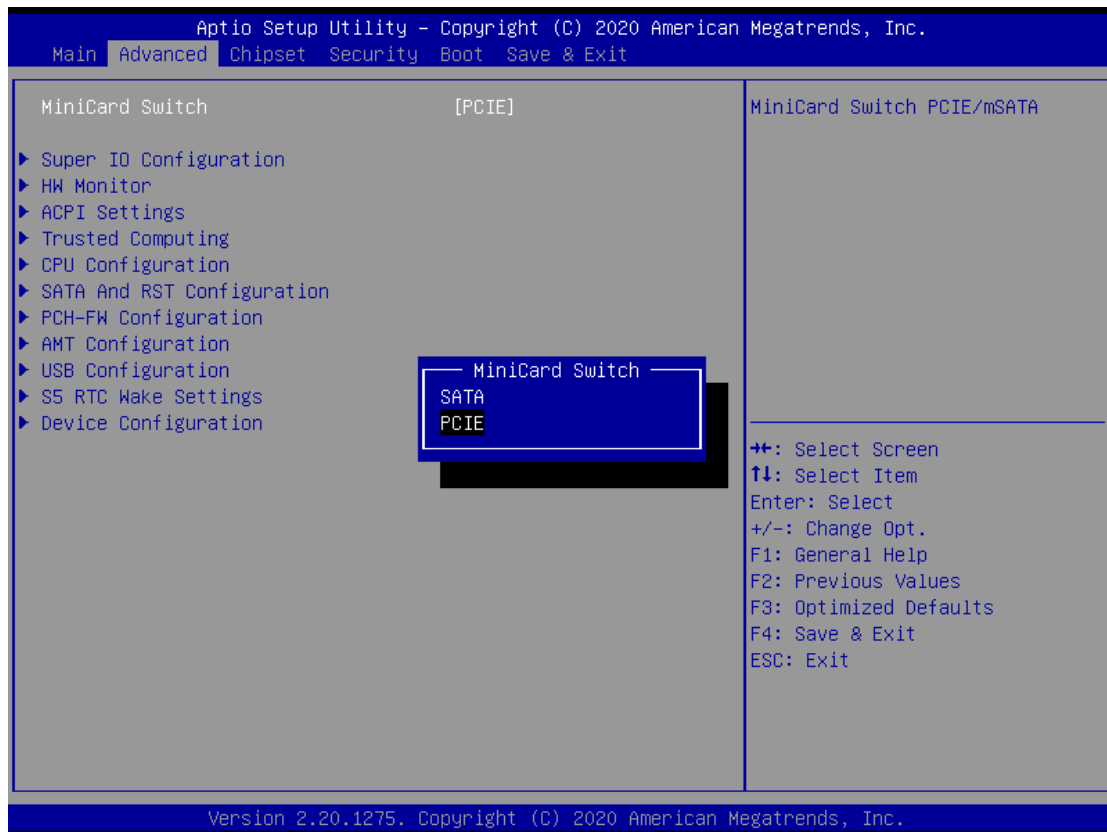

Super IO Configurations

Use this screen to select options for the Super IO Configurations, and change the value of the selected option. A description of the selected item appears on the right side of the screen. For items marked with “▶”, please press <Enter> for more options

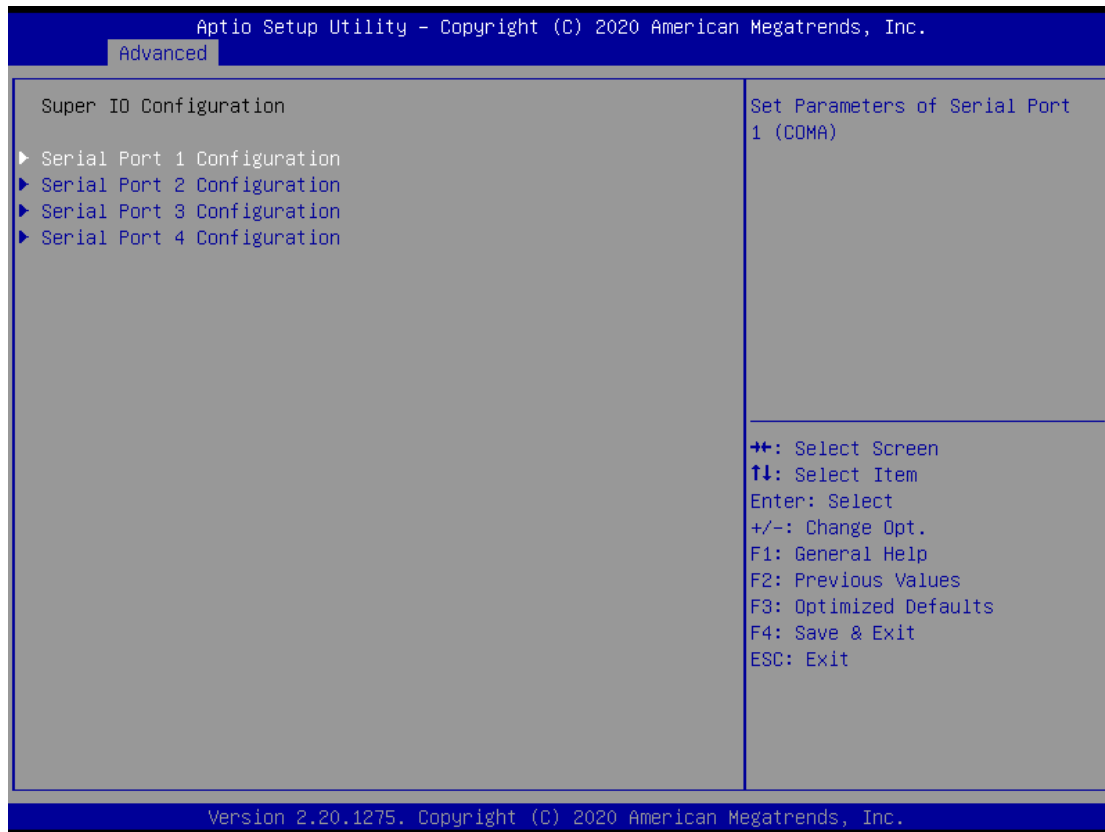

Serial Port 1~4 (COM1~4) Configurations

Use these items to set parameters related to serial ports 1~4.

Serial Port 1

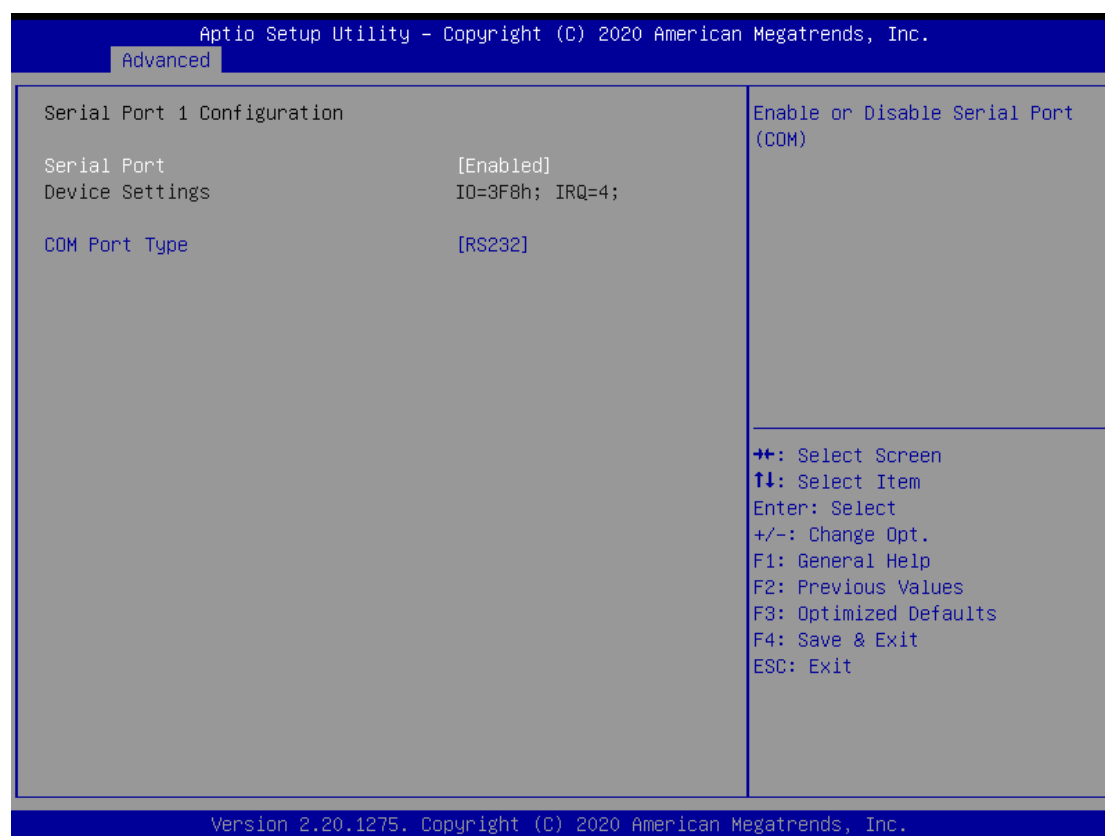

Select Mode

Use this option to set RS-232/RS-422/RS-485 mode.

Serial Port 2

Aptio Setup Utility - Copyright (C) 2020 American Megatrends, Inc.	
Advanced	
Serial Port 2 Configuration	Enable or Disable Serial Port (COM)
Serial Port	[Enabled]
Device Settings	ID=2F8h; IRQ=3;
COM Port Type	[RS232]
	++ : Select Screen ↑↓ : Select Item Enter: Select +/-: Change Opt. F1: General Help F2: Previous Values F3: Optimized Defaults F4: Save & Exit ESC: Exit
Version 2.20.1275. Copyright (C) 2020 American Megatrends, Inc.	

Use this option to set RS-232/RS-422/RS-485 mode.

Serial Port 3

The screenshot shows the Aptio Setup Utility interface. At the top, it reads "Aptio Setup Utility - Copyright (C) 2020 American Megatrends, Inc." and "Advanced". The main area is titled "Serial Port 3 Configuration" and is divided into two columns. The left column lists settings: "Serial Port" (Enabled), "Device Settings" (IO=3E8h; IRQ=7), and "COM Port Type" (RS232). The right column is titled "Enable or Disable Serial Port (COM)". Below this, a legend lists navigation keys: ++ for Select Screen, ↑↓ for Select Item, Enter for Select, +/- for Change Opt., F1 for General Help, F2 for Previous Values, F3 for Optimized Defaults, F4 for Save & Exit, and ESC for Exit. At the bottom, it says "Version 2.20.1275. Copyright (C) 2020 American Megatrends, Inc."

Serial Port 3 Configuration		Enable or Disable Serial Port (COM)
Serial Port	[Enabled]	
Device Settings	IO=3E8h; IRQ=7;	
COM Port Type	[RS232]	

++: Select Screen
↑↓: Select Item
Enter: Select
+/-: Change Opt.
F1: General Help
F2: Previous Values
F3: Optimized Defaults
F4: Save & Exit
ESC: Exit

Version 2.20.1275. Copyright (C) 2020 American Megatrends, Inc.

Use this option to set RS-232 mode.

Serial Port 4

Aptio Setup Utility - Copyright (C) 2020 American Megatrends, Inc.	
Advanced	
Serial Port 4 Configuration	Enable or Disable Serial Port (COM)
Serial Port	[Enabled]
Device Settings	ID=2E8h; IRQ=10;
COM Port Type	[RS232]
	++ : Select Screen ↑↓ : Select Item Enter: Select +/-: Change Opt. F1: General Help F2: Previous Values F3: Optimized Defaults F4: Save & Exit ESC: Exit
Version 2.20.1275. Copyright (C) 2020 American Megatrends, Inc.	

Use this option to set RS-232 mode.

Hardware Monitor

This screen monitors hardware health status.

```
Aptio Setup Utility - Copyright (C) 2020 American Megatrends, Inc.
  Advanced

Pc Health Status

System temperature      : +25 %
CPU temperature        : +81 %
V CORE                 : +0.816 V
+5V_SBY               : +5.056 V
VBAT                   : +2.752 V
+5V                    : +5.056 V
+3.3V                  : +3.280 V

++: Select Screen
↑↓: Select Item
Enter: Select
+/-: Change Opt.
F1: General Help
F2: Previous Values
F3: Optimized Defaults
F4: Save & Exit
ESC: Exit

Version 2.20.1275. Copyright (C) 2020 American Megatrends, Inc.
```

This screen displays the temperature of system and CPU as well as system voltages (V CORE, +5V STBY, VBAT, +5V and +3.3V).

ACPI Settings

Use this screen to select options for the ACPI configuration, and change the value of the selected option. A description of the selected item appears on the right side of the screen.

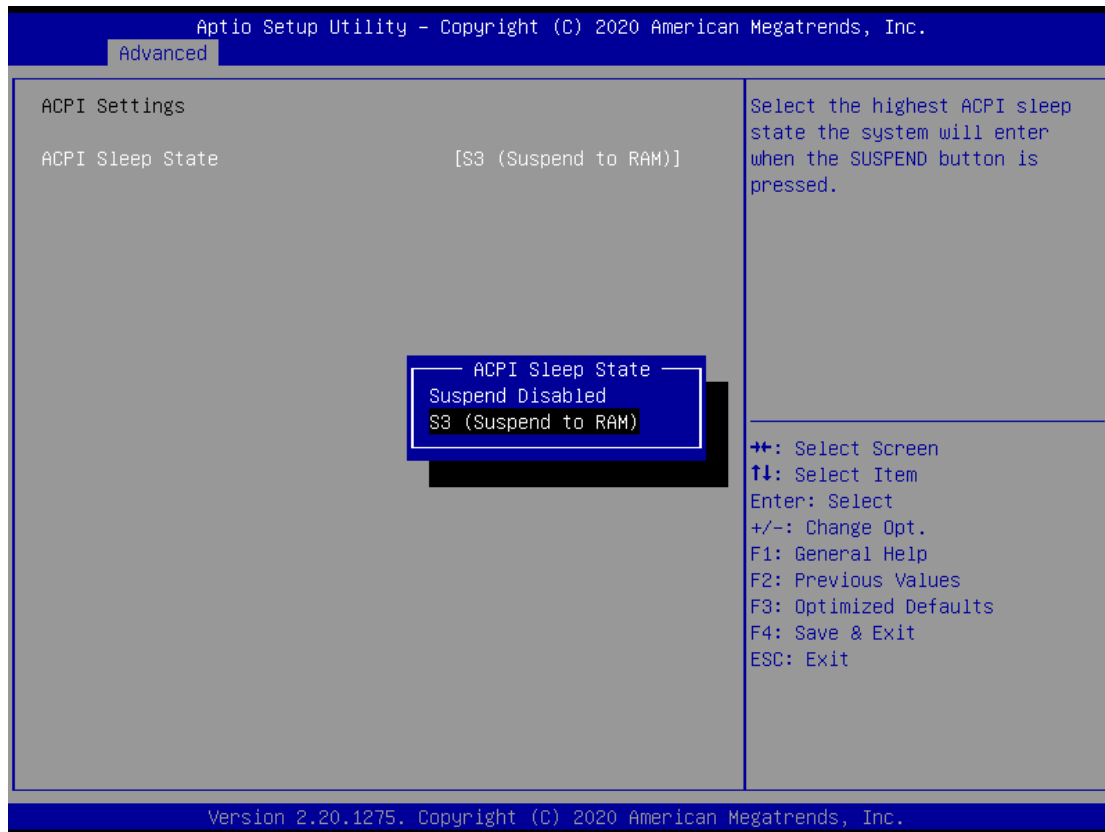

ACPI Sleep State

When the sleep button is pressed, the system will be in the ACPI sleep state.

The default is S3 (Suspend to RAM).

Trust Computing

If users install a security device, such as TPM, users will see the following information for the TPM device and status.

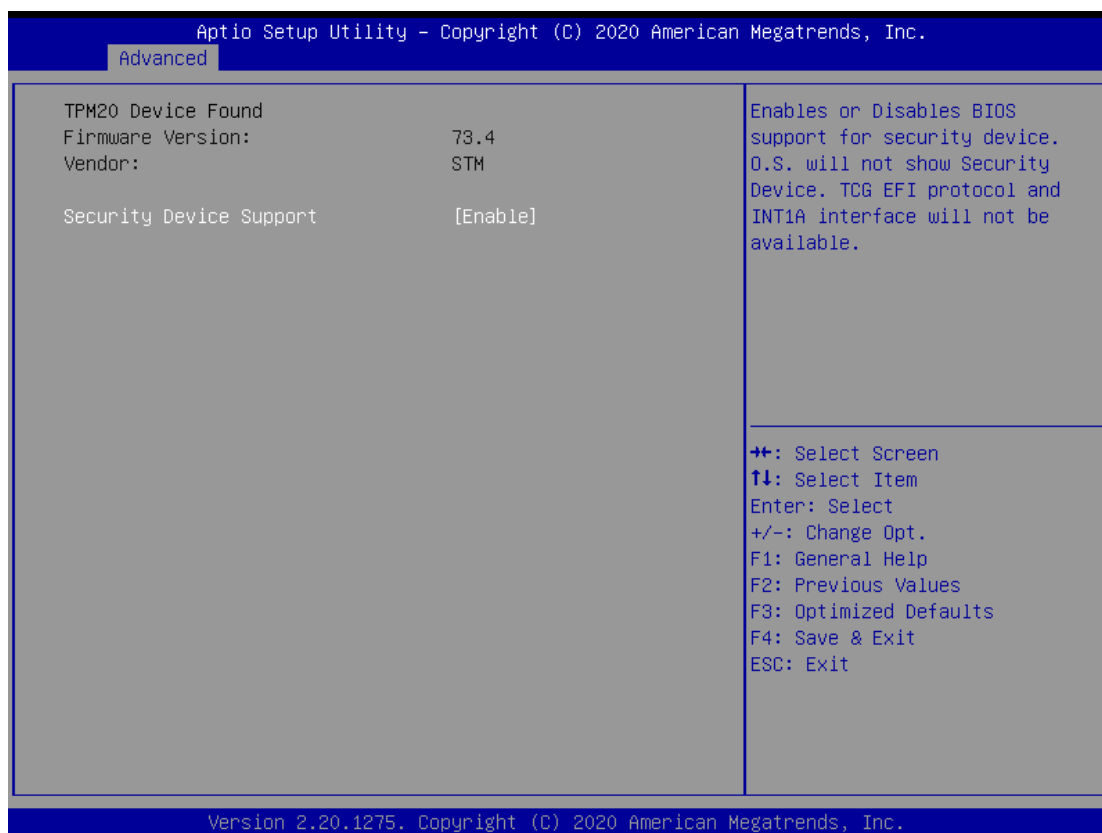

CPU Configuration

This screen shows the CPU version and its detailed information.

Aptio Setup Utility - Copyright (C) 2020 American Megatrends, Inc.

Advanced

CPU Configuration		Enabled or Disabled Hyper-Threading Technology.
Type	Intel(R) Core(TM) i3-8145UE CPU @ 2.20GHz	
ID	0x806EC	
Speed	2400 MHz	
Number of Processors	2Core(s) / 4Thread(s)	
Microcode Revision	B8	
L1 Data Cache	32 KB x 2	
L1 Instruction Cache	32 KB x 2	
L2 Cache	256 KB x 2	
L3 Cache	4 MB	
L4 Cache	N/A	
VMX	Supported	
SMX/TXT	Not Supported	
Hyper-Threading	[Enabled]	
Intel (VMX) Virtualization Technology	[Enabled]	
Intel(R) SpeedStep(tm)	[Enabled]	
Turbo Mode	[Enabled]	

++: Select Screen
 ↑: Select Item
 Enter: Select
 +/-: Change Opt.
 F1: General Help
 F2: Previous Values
 F3: Optimized Defaults
 F4: Save & Exit
 ESC: Exit

Version 2.20.1275. Copyright (C) 2020 American Megatrends, Inc.

Hyper-Threading

Use this item to enable or disable Hyper-Threading Technology, which makes a single physical processor perform multi-tasking functions as two logical ones.

Intel® I Virtualization Technology

It allows a hardware platform to run multiple operating systems separately and simultaneously, enabling one system to virtually function as several systems.

Intel® Speedstep™

Allows more than two frequency ranges to be supported.

Turbo Mode

This item is for enabling or disabling turbo mode. When enabled, it allows processor cores to run faster than marked frequency under certain conditions. The default is Turbo Mode.

SATA & RST Configuration

The SATA controller of the system supports two (2) operating modes: AHCI and Intel RST.

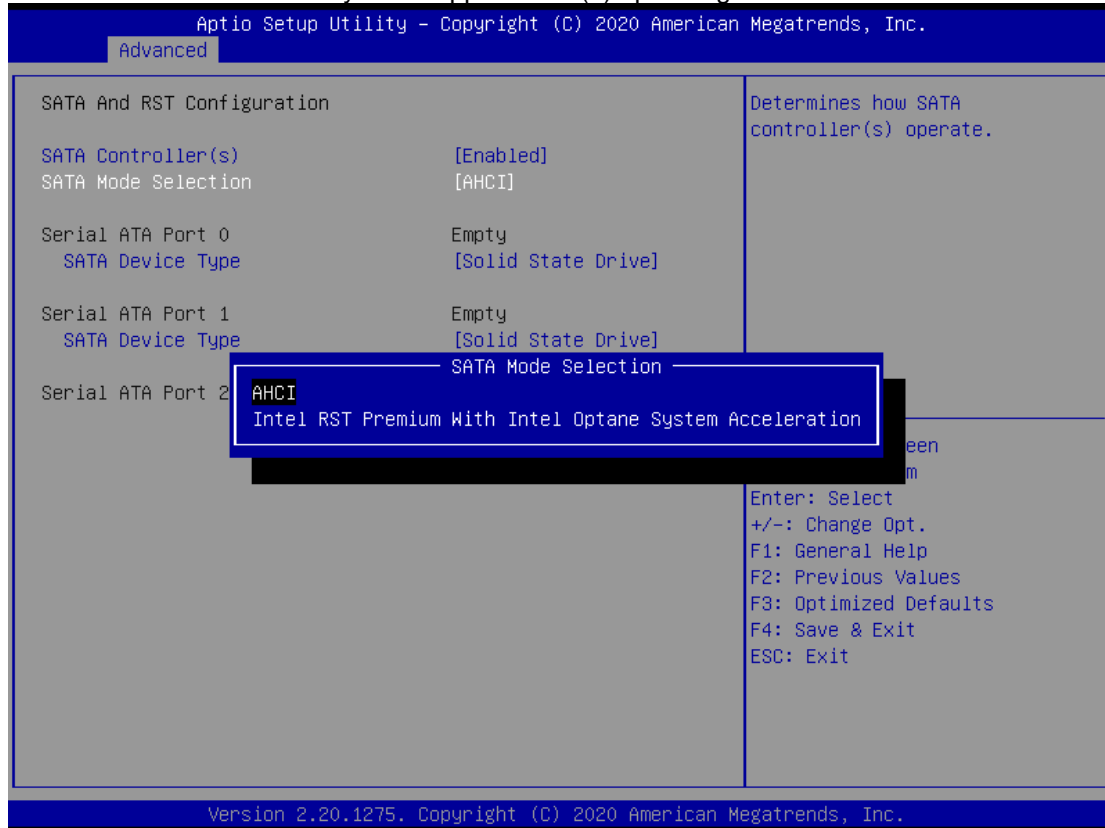

SATA Controller

Enable or disable the SATA Controller feature. The default is Enabled.

SATA Mode Selection

AHCI (Advanced Host Controller Interface) mode is how SATA controller(s) operate.

Serial ATA Port 0-2

It shows the device installed in connector SATA1~2.

RST

The Intel(R) Rapid Storage Technology option appears only when SATA mode is changed to Intel RST Premium With Optane System Acceleration.

PCH-FW Configuration

This screen shows ME Firmware information.

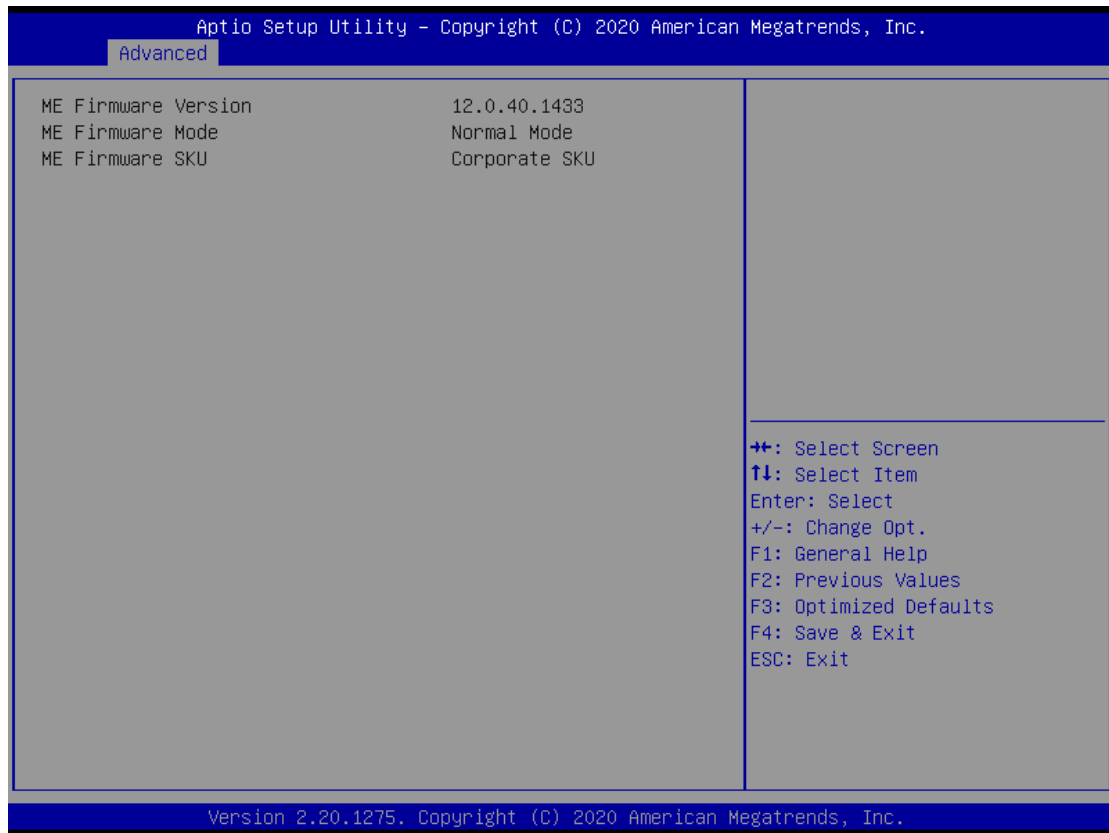

AMT Configurations

Users can use this screen to configure AMT parameters.

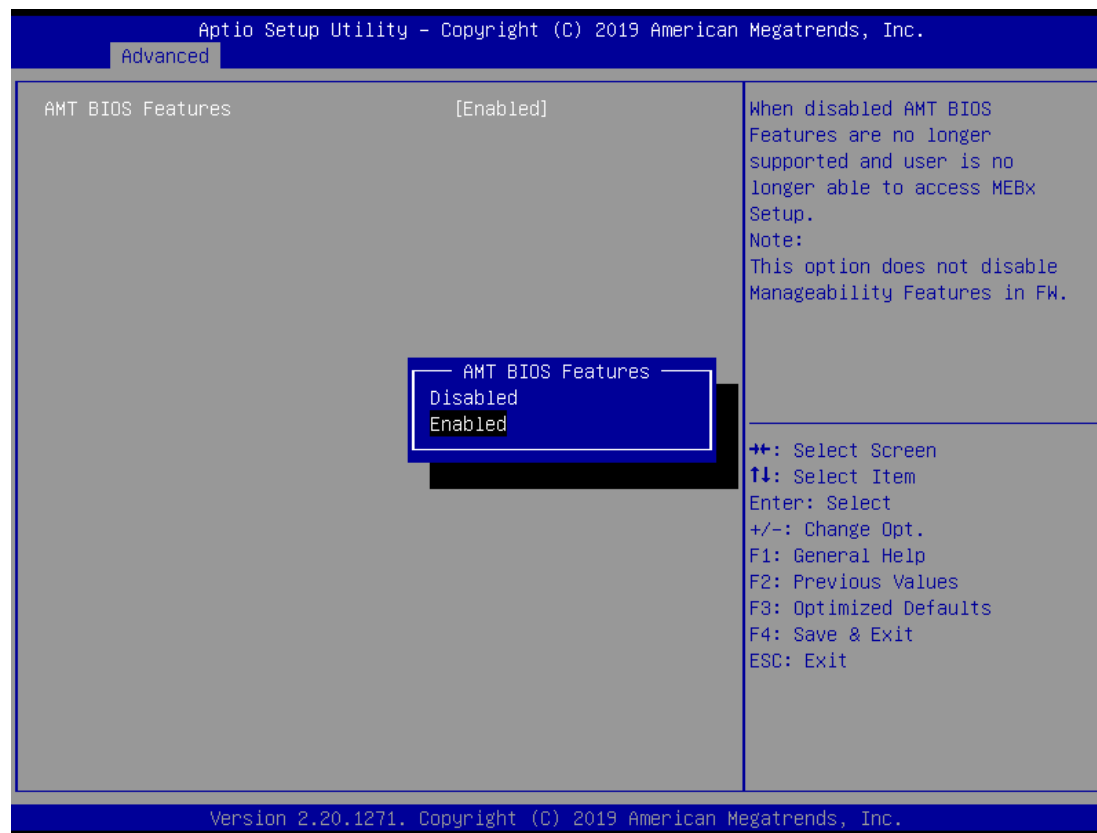

Intel AMT

Enable or disable Intel® Active Management Technology BIOS Extension.

The default is enabled.

USB Configurations

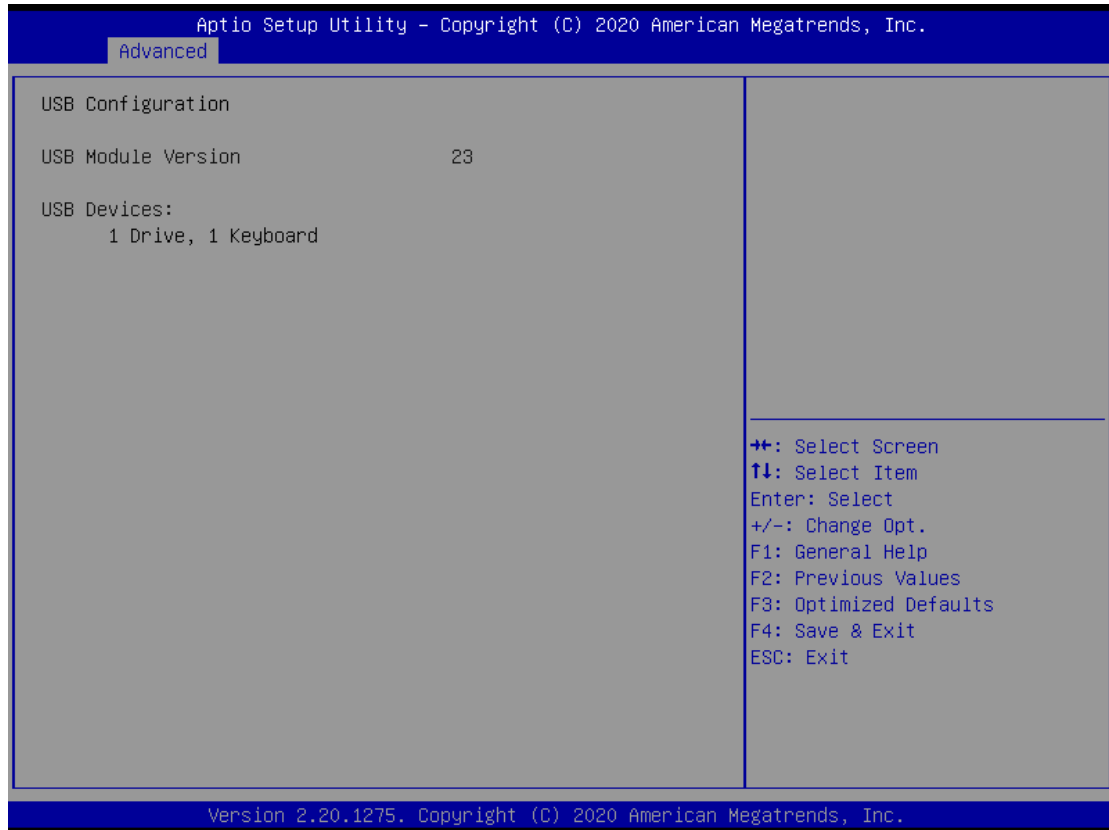

Display all detected USB devices.

S5 RTC Wake Configurations

Enable or disable System wake on alarm event. When Fixed Time is selected, system will wake at the time specified as "hr::min::sec". When Dynamic Time is selected, system will wake at the current time + Increase minutes.

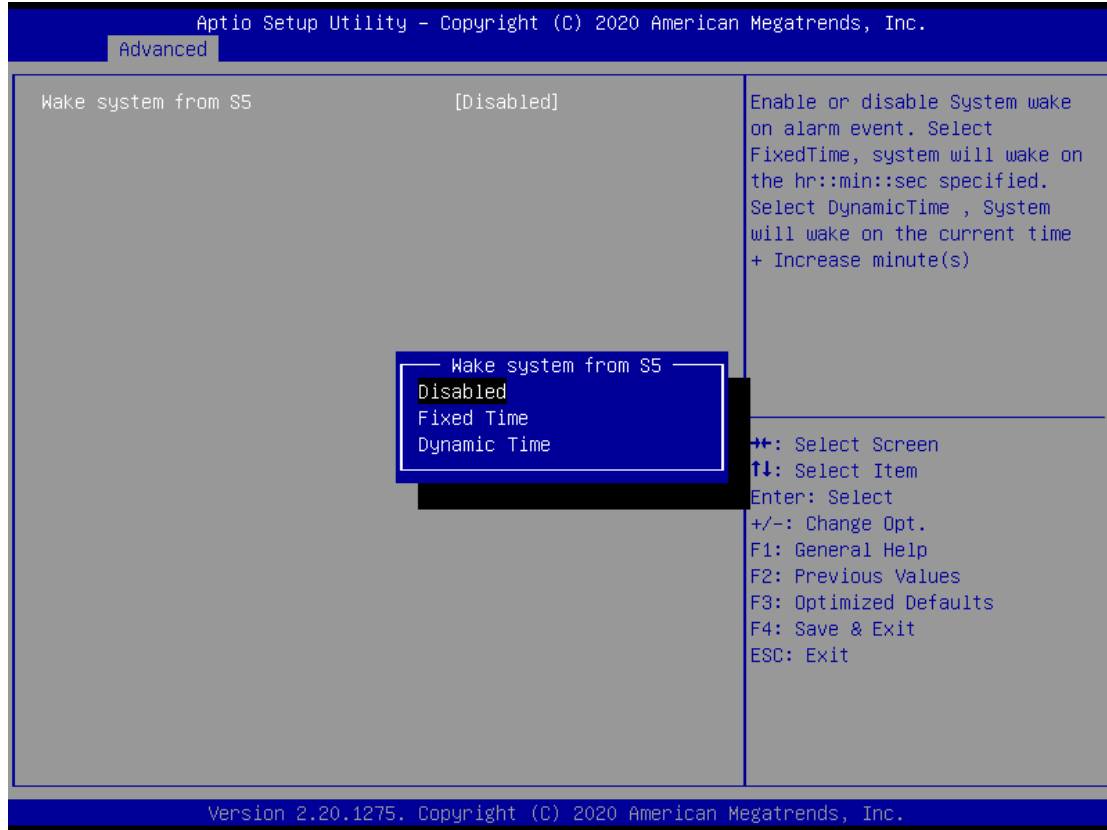

Device Configurations

This item allows users to set the Digital I/O to Input or Output. Default is 4 IN & 4 OUT.

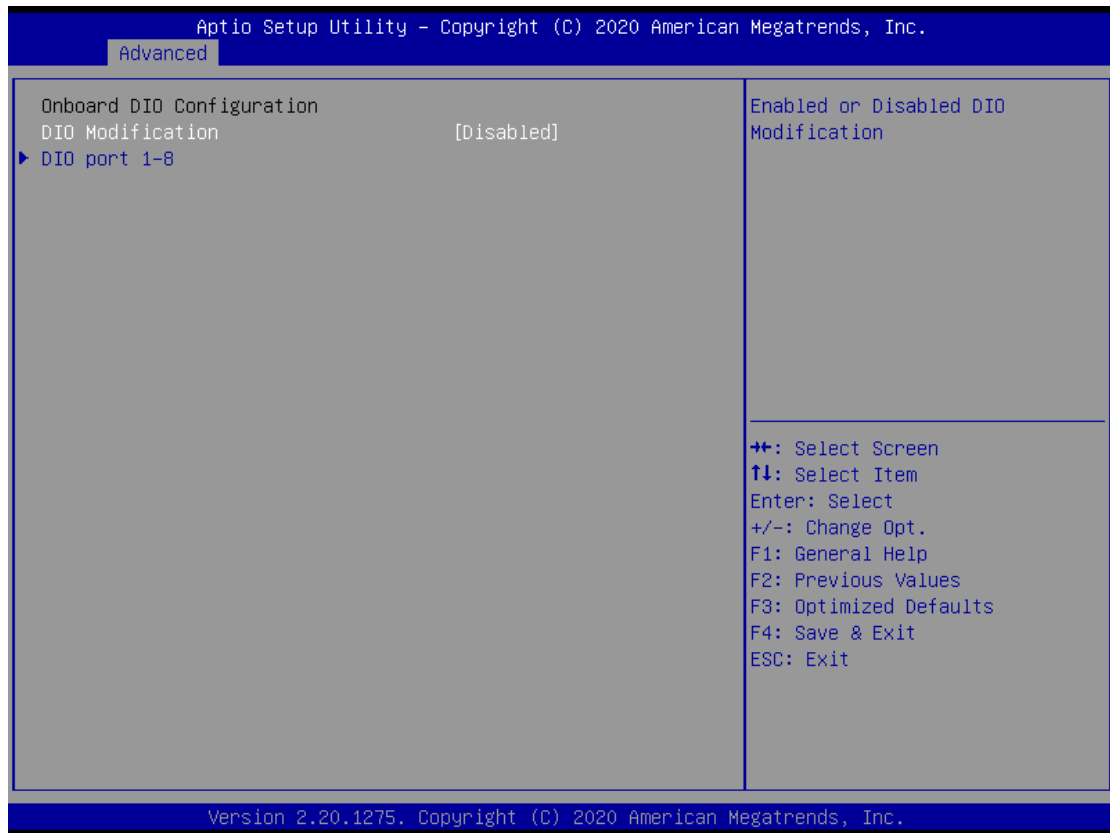

4.5 Chipset Menu

The Chipset menu allows users to change the advanced chipset settings. Users can select any of the items in the left frame of the screen to go to the sub menus:

- ▶ System Agent (SA) Configurations
- ▶ PCH-IO Configurations

For items marked with "▶", please press <Enter> for more options.

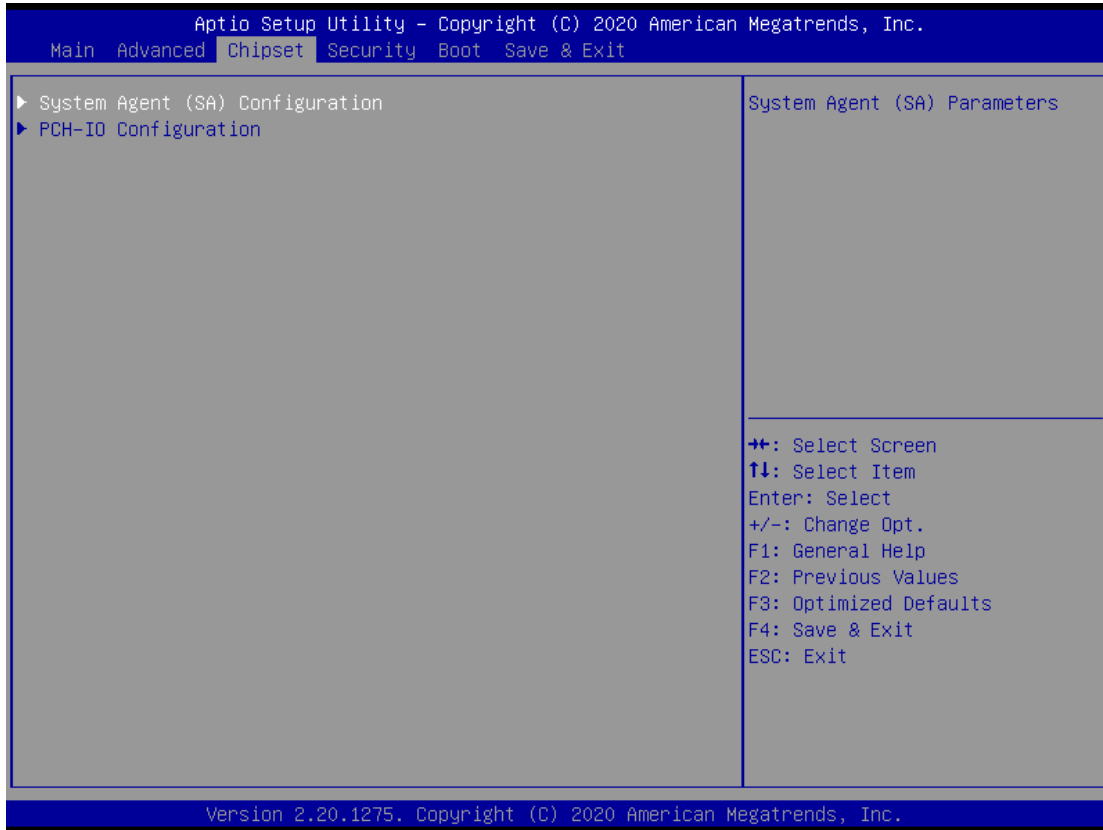

System Agent (SA) Configurations

This screen allows users to configure System Agent (SA) parameters. For items marked with "▶", please press <Enter> for more options.

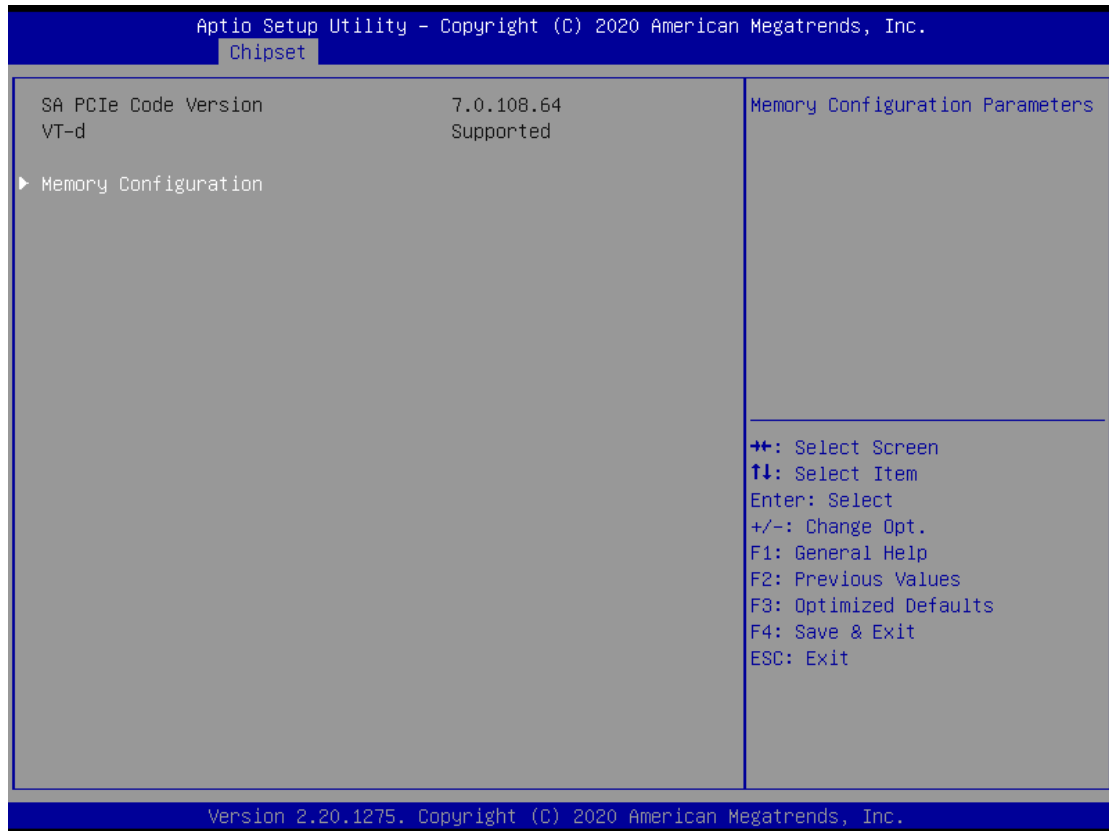

Memory Configuration

Use this item to refer to the information related to system memory.

Memory Configurations

This screen shows the system memory information.

The screenshot displays the 'Memory Configuration' screen within the Aptio Setup Utility. The title bar reads 'Aptio Setup Utility - Copyright (C) 2020 American Megatrends, Inc.' and the current menu is 'Chipset'. The main area is divided into two columns. The left column lists memory details: 'Memory RC Version' (0.7.1.111), 'Memory Size' (8192 MB), 'Channel 0 Slot 0' (Populated & Enabled), 'Channel 0 Slot 0 Size' (8192 MB (DDR4)), 'Channel 0 Slot 0 Number of Ranks' (2), 'Channel 0 Slot 0 Manufacturer' (UnKnown), and 'Channel 1 Slot 0' (Not Populated / Disabled). The right column contains a legend for navigation keys: '←→: Select Screen', '↑↓: Select Item', 'Enter: Select', '+/-: Change Opt.', 'F1: General Help', 'F2: Previous Values', 'F3: Optimized Defaults', 'F4: Save & Exit', and 'ESC: Exit'. The footer of the screen shows 'Version 2.20.1275. Copyright (C) 2020 American Megatrends, Inc.'

Memory Configuration	
Memory RC Version	0.7.1.111
Memory Size	8192 MB
Channel 0 Slot 0	Populated & Enabled
Channel 0 Slot 0 Size	8192 MB (DDR4)
Channel 0 Slot 0 Number of Ranks	2
Channel 0 Slot 0 Manufacturer	UnKnown
Channel 1 Slot 0	Not Populated / Disabled

←→: Select Screen
↑↓: Select Item
Enter: Select
+/-: Change Opt.
F1: General Help
F2: Previous Values
F3: Optimized Defaults
F4: Save & Exit
ESC: Exit

Version 2.20.1275. Copyright (C) 2020 American Megatrends, Inc.

PCH-IO Configurations

This screen allows users to set PCH parameters.

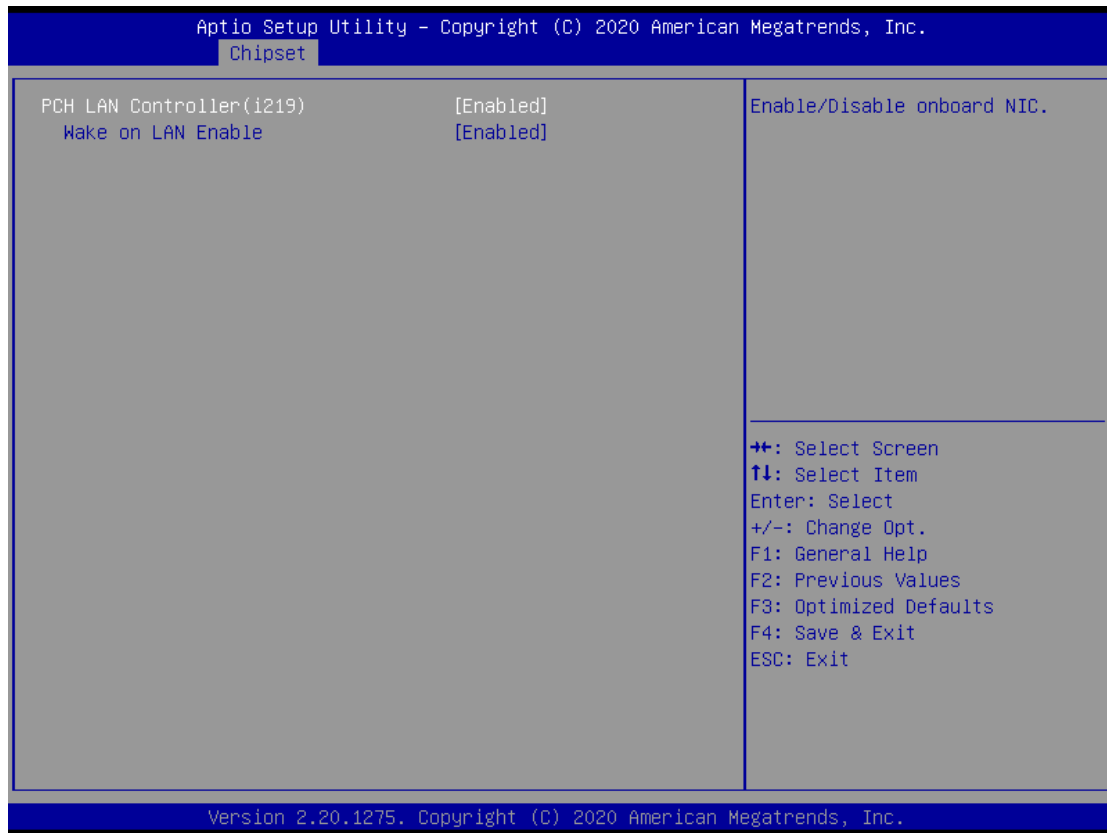

Security Menu

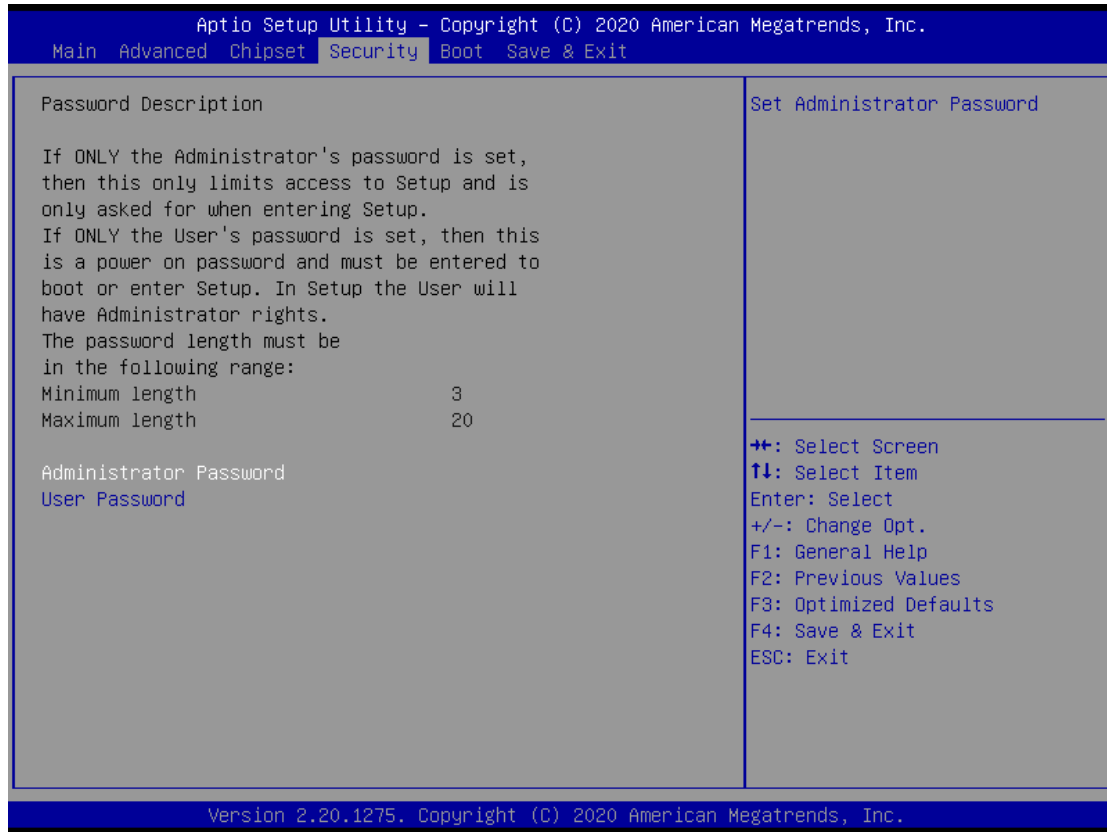

Administrator Password

This item indicates whether an administrator password has been set (installed or uninstalled).

User Password

This item indicates whether a user password has been set (installed or uninstalled).

4.6 Boot Menu

The Boot menu allows users to change boot options of the system.

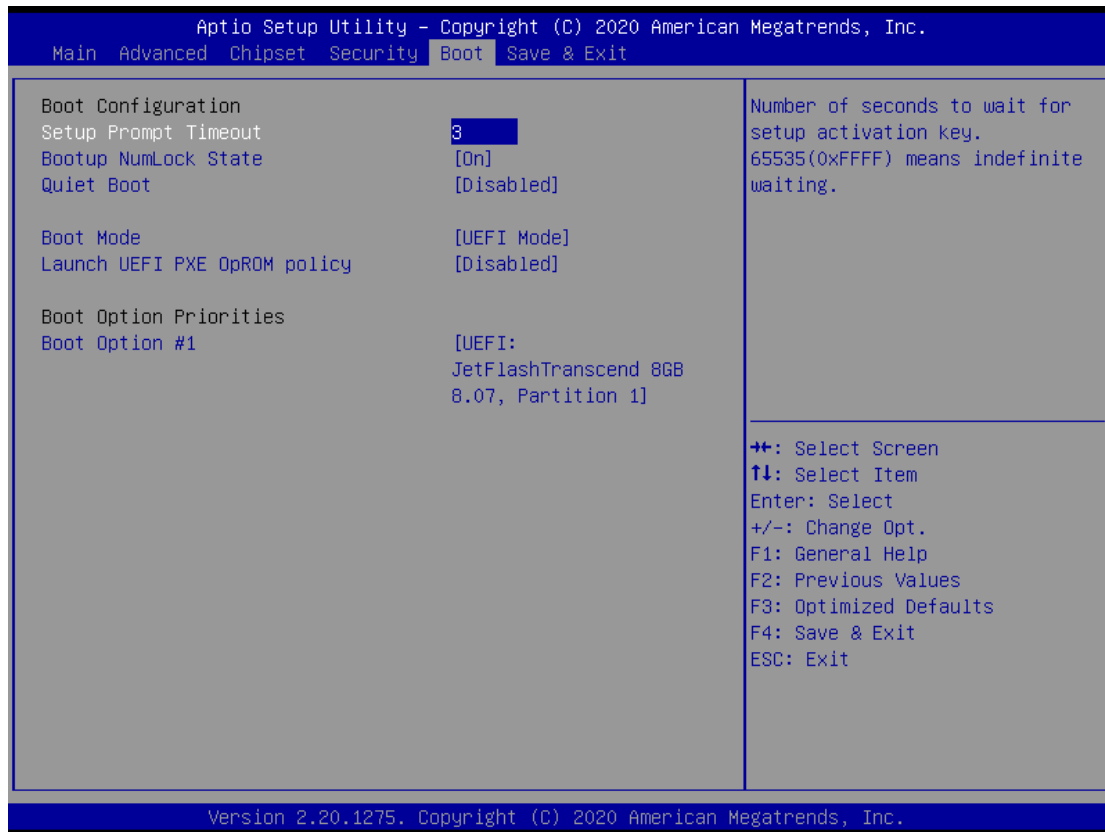

Setup Prompt Timeout

Use this item to set up number of seconds to wait for setup activation key where 65535(0xFFFF) means indefinite waiting.

Bootup NumLock State

Use this item to select the power-on state for the keyboard NumLock.

Quiet Boot

Select to display either POST output messages or a splash screen during boot-up.

Boot Option Priorities

These are settings for boot priority. Specify the boot device priority sequence from the available devices.

4.7 Save & Exit Menu

The Save & Exit menu allows users to load system configurations with optimal or fail-safe default values.

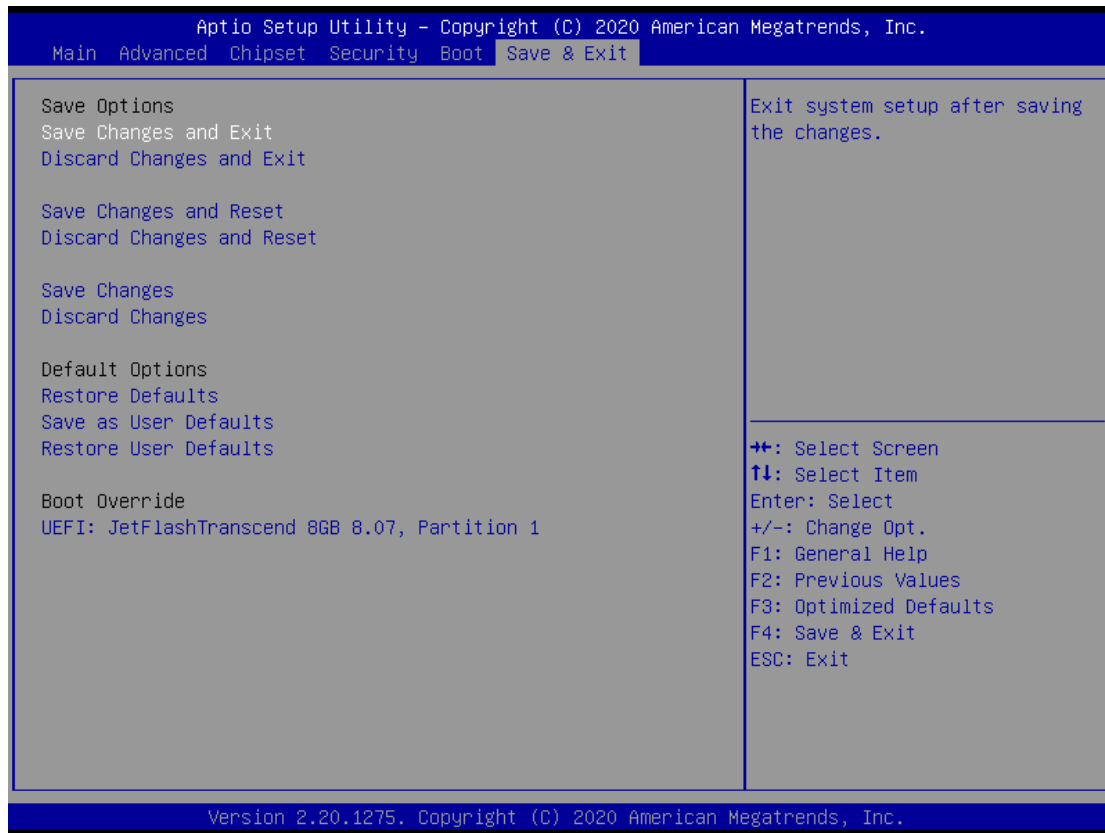

Save Changes and Exit

When users have completed the system configuration changes, select this option to leave Setup and return to Main Menu. Select Save Changes and Exit from the Save & Exit menu and press <Enter>. Select Yes to save changes and exit.

Discard Changes and Exit

Select this option to quit Setup without making any permanent changes to the system configurations and return to Main Menu. Select Discard Changes and Exit from the Save & Exit menu and press <Enter>. Select Yes to discard changes and exit.

Save Changes and Reset

Having completed the system configuration changes, select this option to leave Setup and reboot the computer so the new system configurations take effect. Select Save Changes and Reset from the Save & Exit menu and press <Enter>. Select Yes to save changes and reset.

Discard Changes and Reset

Select this option to quit Setup without making any permanent changes to the system configuration and reboot the computer. Select Discard Changes and Reset from the Save & Exit menu and press <Enter>. Select Yes to discard changes and reset.

Save Changes

Having completed the system configuration changes, select this option to save changes. Select Save Changes from the Save & Exit menu and press <Enter>. Select Yes to save changes.

Discard Changes

Select this option to quit Setup without making any permanent changes to the system configurations. Select Discard Changes from the Save & Exit menu and press <Enter>. Select Yes to discard changes.

Restore Defaults

It automatically sets all Setup options to a complete set of default settings when users select this option. Select Restore Defaults from the Save & Exit menu and press <Enter>.

Save as User Defaults

Select this option to save system configuration changes done so far as User Defaults. Select Save as User Defaults from the Save & Exit menu and press <Enter>.

Restore User Defaults

It automatically sets all Setup options to a complete set of User Defaults when users select this option. Select Restore User Defaults from the Save & Exit menu and press <Enter>.

Boot Override

Select a drive to immediately boot that device regardless of the current boot order.

This page is intentionally left blank.

APPENDIX A WATCHDOG TIMER

About Watchdog Timer

Software stability is major issue in most applications. Some embedded systems are not watched by human for 24 hours. It is usually too slow to wait for someone to reboot when a computer hangs. The system needs to be able to reset automatically when things go wrong. The watchdog timer gives us solutions in this regard.

The watchdog timer is a counter that triggers a system to reset when it counts down to zero from a preset value. The software starts the counter with an initial value and must reset it periodically. If the counter ever reaches zero which means the software has crashed, the system will reboot.

Sample Program

The following example enables configurations using a debug tool.

Enable WDT

↓

Enable configuration:

O 2E 87; Un-lock super I/O
O 2E 87

↓

Select logic device:

O 2E 07
O 2F 08

↓

WDT device enable:

O 2E 30
O 2F 01

↓

Set timer unit:

O 2E F0
O 2F 00 ; (00: Sec; 08:Minute)

↓

Set base timer:

O 2E F1
O 2F 0A; Set reset time (where 0A (hex) = 10sec)

Disable WDT

↓

Enable configuration:

O 2E 87; Un-lock super I/O
O 2E 87

↓

Select logic device:

O 2E 07
O 2F 08

↓

WDT device disable:

O 2E 30
O 2F 00