



AXIOMTEK

CEM846

**Intel® Atom™ E3845/ E3827/ E3815
Processors COM Express™ Type 10
Mini Module**

User's Manual



Disclaimers

This manual has been carefully checked and believed to contain accurate information. Axiomtek Co., Ltd. assumes no responsibility for any infringements of patents or any third party's rights, and any liability arising from such use.

Axiomtek does not warrant or assume any legal liability or responsibility for the accuracy, completeness or usefulness of any information in this document. Axiomtek does not make any commitment to update the information in this manual.

Axiomtek reserves the right to change or revise this document and/or product at any time without notice.

No part of this document may be reproduced, stored in a retrieval system, or transmitted, in any form or by any means, electronic, mechanical, photocopying, recording, or otherwise, without the prior written permission of Axiomtek Co., Ltd.

CAUTION

If you replace wrong batteries, it causes the danger of explosion. It is recommended by the manufacturer that you follow the manufacturer's instructions to only replace the same or equivalent type of battery, and dispose of used ones.

©Copyright 2016 Axiomtek Co., Ltd.

All Rights Reserved

January 2016, Version A1

Printed in Taiwan

ESD Precautions

Computer boards have integrated circuits sensitive to static electricity. To prevent chipsets from electrostatic discharge damage, please take care of the following jobs with precautions:

- Do not remove boards or integrated circuits from their anti-static packaging until you are ready to install them.
- Before holding the board or integrated circuit, touch an unpainted portion of the system unit chassis for a few seconds. It discharges static electricity from your body.
- Wear a wrist-grounding strap, available from most electronic component stores, when handling boards and components.

Trademarks Acknowledgments

Axiomtek is a trademark of Axiomtek Co., Ltd.

Windows[®] is a trademark of Microsoft Corporation.

AMI is a trademark of American Megatrend Inc.

IBM, PC/AT, PS/2, VGA are trademarks of International Business Machines Corporation.

Intel[®] is a trademark of Intel Corporation.

Other brand names and trademarks are the properties and registered brands of their respective owners.

Table of Contents

Disclaimers.....	ii
ESD Precautions.....	iii
Chapter 1 Introduction.....	1
1.1 Features.....	1
1.2 Specifications.....	2
1.3 Utilities Supported.....	3
Chapter 2 Module and Pin Assignments.....	5
2.1 Module Dimensions and Fixing Holes.....	5
2.2 Module Layout.....	7
2.3 Installing Thermal Solution.....	8
2.4 Switch Settings.....	9
2.4.1 Auto Power On and Restore BIOS Optimal Defaults (SW1).....	9
2.5 Connector.....	10
2.5.1 COM Express™ Connector (SJ1).....	10
Chapter 3 Hardware Description.....	13
3.1 Microprocessor.....	13
3.2 BIOS.....	13
3.3 System Memory.....	13
3.4 I/O Port Address Map.....	14
3.5 Interrupt Controller (IRQ) Map.....	16
3.6 Memory Map.....	19
Chapter 4 AMI BIOS Setup Utility.....	21
4.1 Starting.....	21
4.2 Navigation Keys.....	21
4.3 Main Menu.....	23
4.4 Advanced Menu.....	24
4.5 Chipset Menu.....	35
4.6 Security Menu.....	38
4.7 Boot Menu.....	39
4.8 Save & Exit Menu.....	40

Appendix A	Watchdog Timer	43
A.1	About Watchdog Timer	43
A.2	How to Use Watchdog Timer	43
Appendix B	Digital I/O	45
B.1	About Digital I/O	45
B.2	How to Use Digital I/O	45
Appendix C	BIOS Flash Utility	47

This page is intentionally left blank.

Chapter 1

Introduction

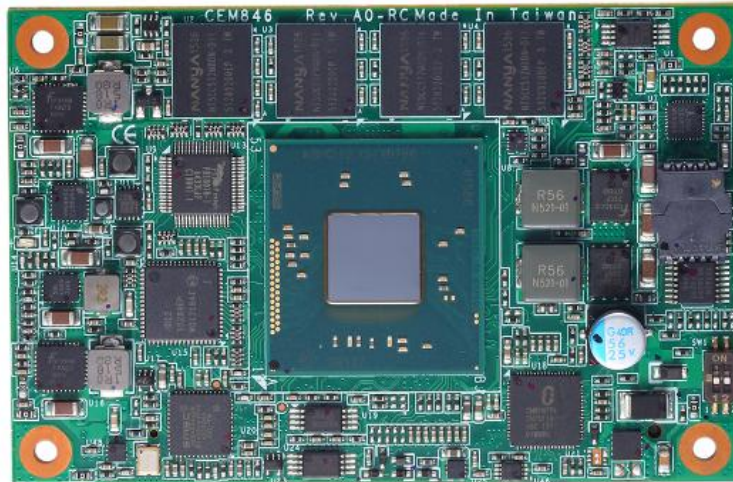

The CEM846 is a new COM Express™ Type 10 Mini Module supporting Intel® Atom™ E3845/ E3827/ E3815 processors. It delivers outstanding system performance and supports high speed I/Os like PCI-Express Gen 2 at 5GT/s, SuperSpeed USB 3.0 at 5Gb/s, and SATA-300 at 3Gb/s. The CEM846 does fully comply with PICMG COM.0 Rev 2.1 COM Express™ Type 10 specification. It provides 4 Lanes of PCI-Express, Gigabit Ethernet, HD audio interface, LVDS LCD and one configurable DDI for more flexible digital display options.

1.1 Features

- Intel® Atom™ E3845/ E3827/ E3815 processors
- Onboard DDR3L with memory capacity up to 4GB
- Support 4 Lanes of PCI-Express Gen 2 at 5GT/s (Lane 4 is occupied by Intel® Giga LAN).
- 2 SATA-300
- 1 USB 3.0
- 8 USB 2.0

1.2 Specifications

- **CPU**
 - Intel® Atom™ quad core E3845 1.91GHz processor.
 - Intel® Atom™ dual core E3827 1.75GHz processor.
 - Intel® Atom™ single core E3815 1.46GHz processor.
- **BIOS**
 - American Megatrends Inc. BIOS.
 - 16Mbit SPI Flash, DMI, Plug and Play.
 - PXE Ethernet Boot ROM, customized default saving features, LPC-free supported.
- **System Memory**
 - Onboard DDR3L 1333/1066MHz memory supports maximum capacity up to 4GB.
- **Expansion Interface**
 - Four PCI-Express x1 or three PCI-Express x1 while internal LAN is connected.
- **USB Interface**
 - One USB complies with USB Spec. Rev. 3.0.
 - Eight USB comply with USB Spec. Rev. 2.0.



USB 2.0 port 4~7 do not support wake up function.

Note

- **SATA Interface**
 - Two SATA 3Gb/s ports supported through COM Express™ connector.
- **Graphics**
 - Integrated in processor HD graphics Gen 7.
 - 18/24-bit single channel LVDS interface with max. resolution up to 1366x768.
 - One DDI port supports HDMI 1.4/DVI/DisplayPort 1.1a.
 - HDMI/DVI: up to 1920x1080 @60Hz 24bpp.
 - DP: up to 2560x1600 @60Hz 24bpp.
- **Ethernet**
 - One 1000/100/10 Base-T provided by Intel® i210IT with integrated boot ROM.
- **HD Audio Interface**
 - Intel® High Definition audio.
- **Hardware Monitoring**
 - Detect CPU/system temperature, voltage and fan speed.
- **Watchdog Timer**
 - 1~255 seconds or minutes; up to 255 levels.
- **General Purpose Serial Interface**
 - Support two UART interfaces.
- **Power Management**
 - ACPI (Advanced Configuration and Power Interface).
- **Form Factor**
 - Mini module 84mm x 55mm.

1.3 Utilities Supported

- Chipset driver
- Graphics driver
- Ethernet driver
- USB 3.0 XHCI driver (only for Windows® 7)
- Trusted Execution Engine (only for Windows® 8)
- Sideband Fabric Device (only for Windows® 8)



Note

All specifications and images are subject to change without notice.

This page is intentionally left blank.

Chapter 2

Module and Pin Assignments

2.1 Module Dimensions and Fixing Holes

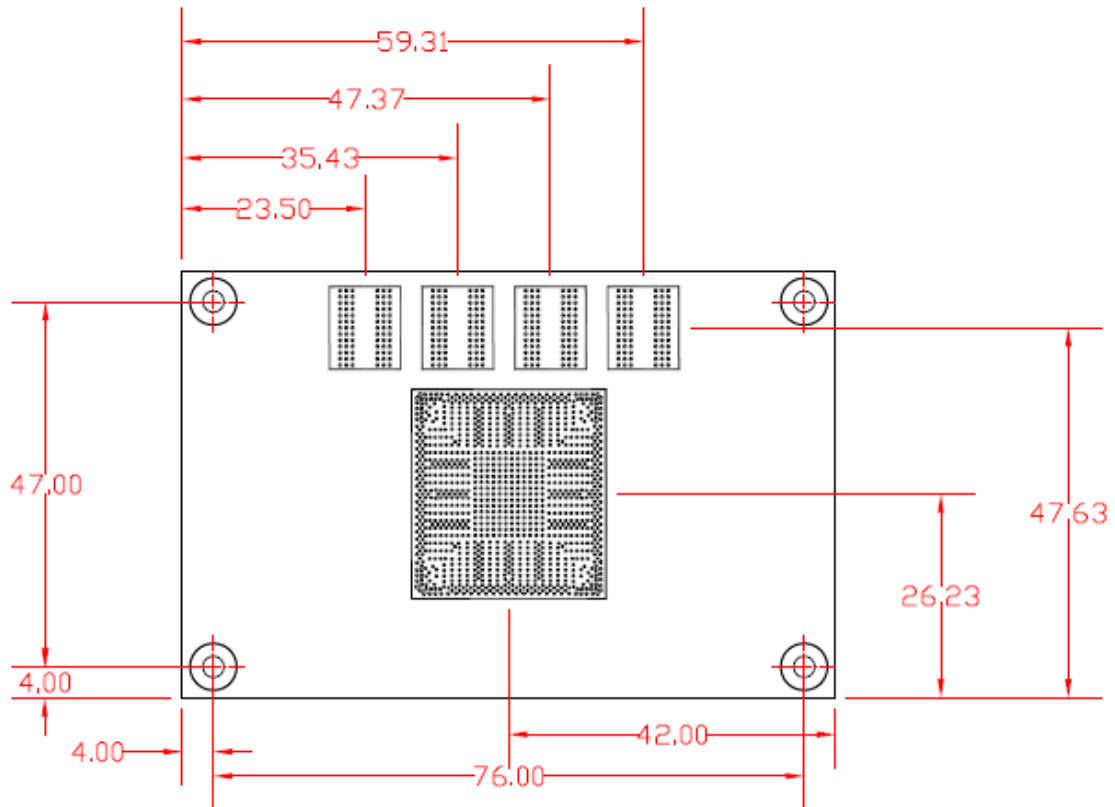

Top View

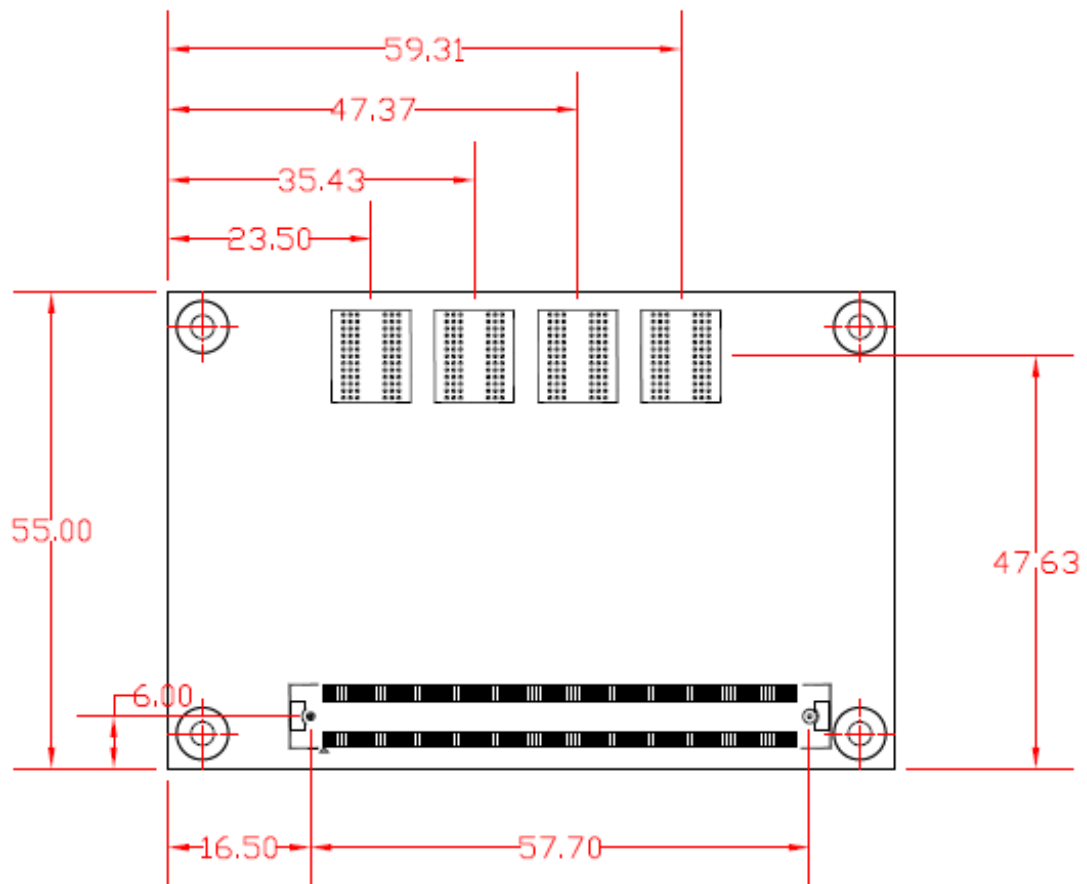

Bottom View

2.2 Module Layout

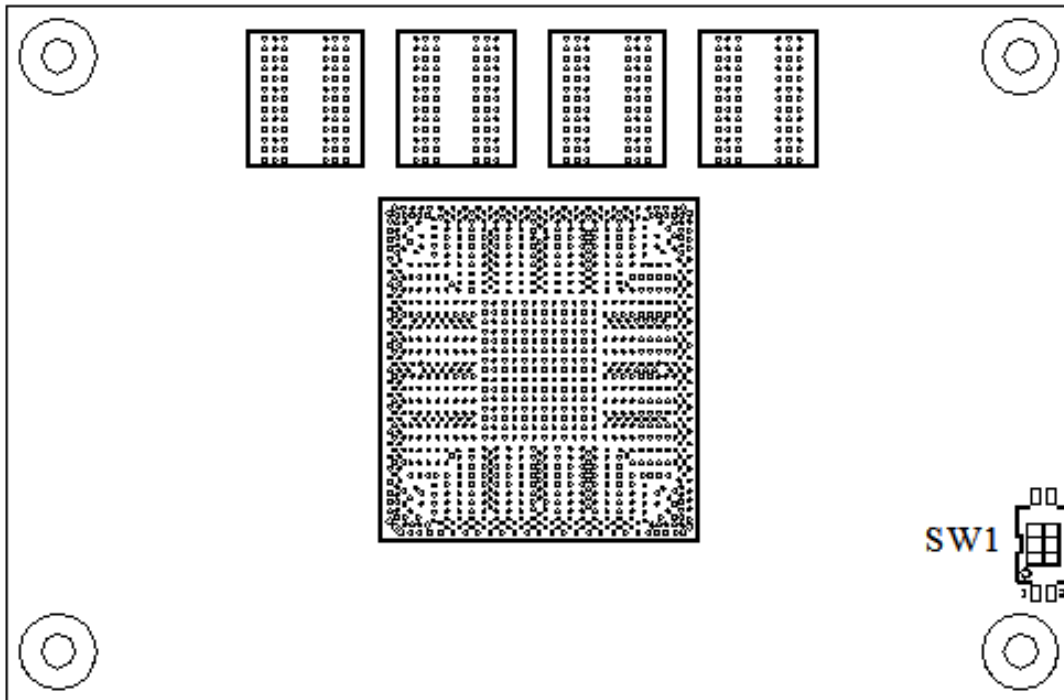

Top View

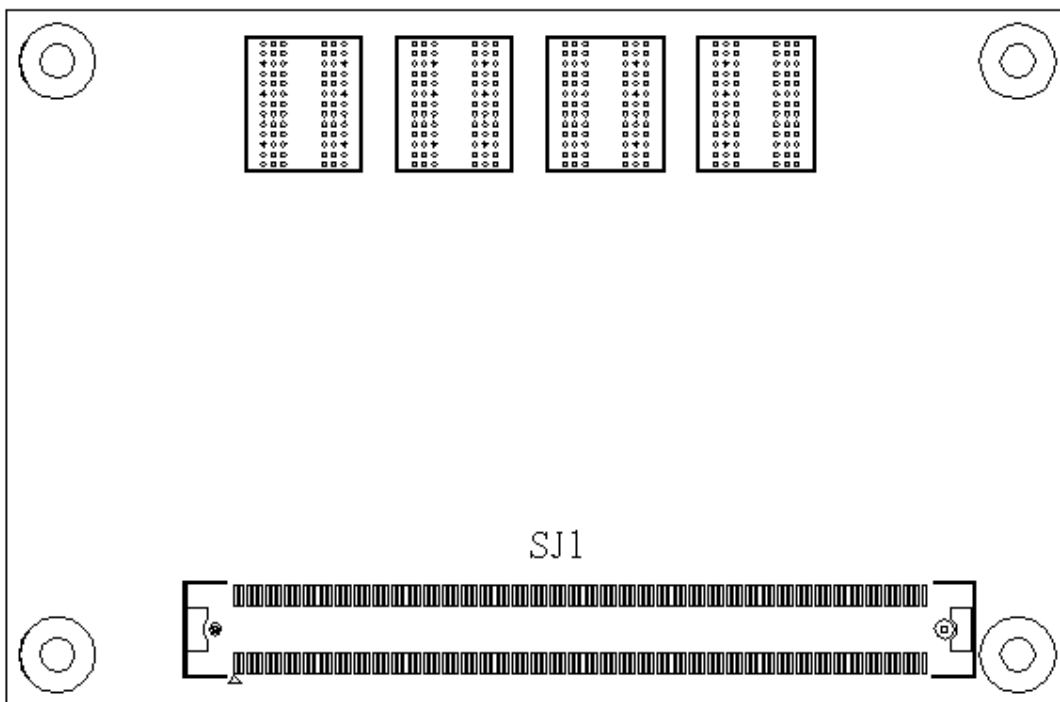

Bottom View

2.3 Installing Thermal Solution

For thermal dissipation, a thermal solution enables the CEM846's components to dissipate heat efficiently. All heat generating components are thermally conducted to the heatsink in order to avoid hot spots. Below images illustrate how to install the thermal solution on CEM846.

1. There is a protective plastic covering on the thermal pads. This must be removed before the heatspreader can be mounted.
2. Each thermal solution is designed for a specific CEM module. The thermal pads on the heatspreader are designed to make contact with the necessary components on the CEM module. When mounting the heatspreader you must make sure that the thermal pads on the heatspreader make complete contact (no space between thermal pad and component) with the corresponding components on the CEM module. This is especially critical for CEM modules that have higher CPU speeds (for example 1.46GHz or more) to ensure that the heatspreader acts as a proper thermal interface for cooling solutions.
3. Before installing the heatspreader to the CPU module, please apply thermal grease on the CPU die. This CPU module has four assembly holes for installing heatspreader plate. Use the four screws to secure the heatspreader plate to the CEM846. Be careful not to over-tighten the screws. Then, apply thermal grease at the bottom of heatsink and secure the heatsink on the heatspreader by another four screws.

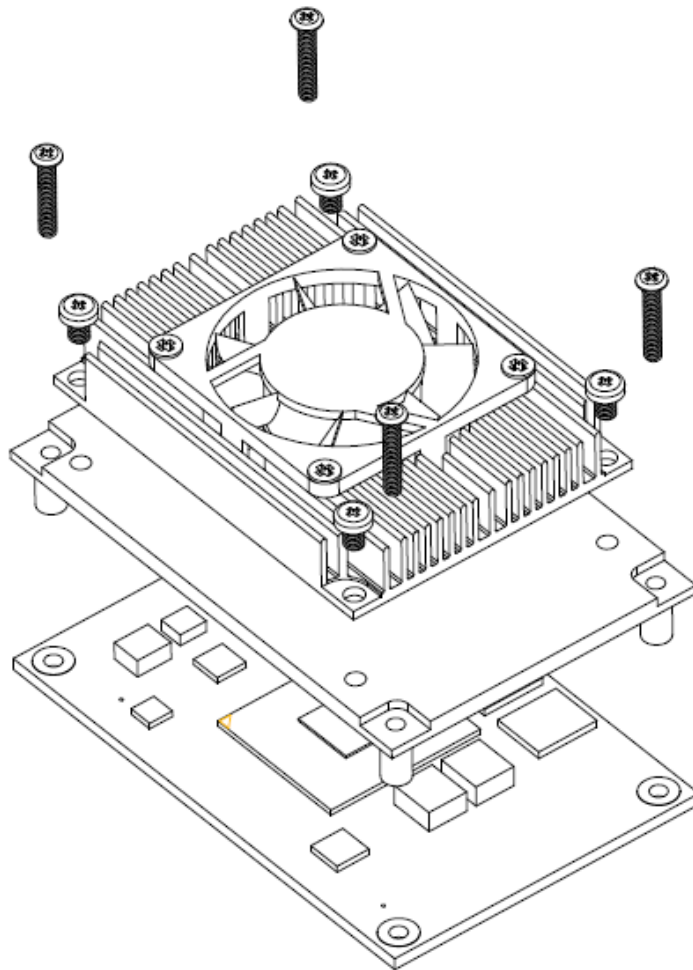

2.4 Switch Settings

Properly configure switch settings on the CEM846 to meet your application purpose. Below you can find a summary table of switch and onboard default setting.



Note

Once the default switch setting needs to be changed, please do it under power-off condition.

Switch	Description	Setting
SW1	Auto Power On Default: Disable	SW1-1 ON
	Restore BIOS Optimal Defaults Default: Normal Operation	SW1-2 OFF

2.4.1 Auto Power On and Restore BIOS Optimal Defaults (SW1)

If dip1 of SW1 (SW1-1) is enabled for power input, the system will be automatically power on without pressing soft power button. If this jumper is disabled for power input, it is necessary to manually press soft power button to power on the system.

The dip2 of SW1 (SW1-2) is for restoring BIOS default status. Flip SW1-2 to ON position for a few seconds then flip it back to OFF position. Doing this procedure can restore BIOS optimal defaults.

Function	Setting
Disable auto power on (Default)	SW1-1 ON
Enable auto power on	SW1-1 OFF
Restore BIOS optimal defaults	SW1-2 ON
Normal operation (Default)	SW1-2 OFF



2.5 Connector

Signals go to the other parts of the system through connector. Loose or improper connection might cause problems, please make sure the COM Express™ connector is properly and firmly connected.

Connector	Description
SJ1	COM Express™ Connector

2.5.1 COM Express™ Connector (SJ1)

The following table shows pin assignments of the 220-pin COM Express™ connector.

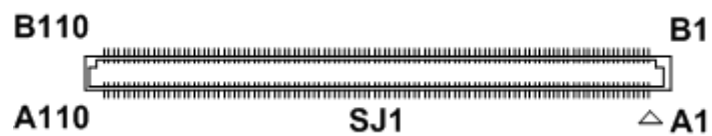

Pin	Signal	Pin	Signal	Pin	Signal	Pin	Signal
A1	GND (FIXED)	B1	GND (FIXED)	A56	N.C.	B56	N.C.
A2	GBE0_MDI3-	B2	GBE0_ACT#	A57	GND	B57	GPO2
A3	GBE0_MDI3+	B3	LPC_FRAME#	A58	N.C.	B58	N.C.
A4	GBE0_LINK100#	B4	LPC_AD0	A59	N.C.	B59	N.C.
A5	GBE0_LINK1000#	B5	LPC_AD1	A60	GND (FIXED)	B60	GND (FIXED)
A6	GBE0_MDI2-	B6	LPC_AD2	A61	PCIE_TX2+	B61	PCIE_RX2+
A7	GBE0_MDI2+	B7	LPC_AD3	A62	PCIE_TX2-	B62	PCIE_RX2-
A8	GBE0_LINK#	B8	N.C.	A63	GPI1	B63	GPO3
A9	GBE0_MDI1-	B9	N.C.	A64	PCIE_TX1+	B64	PCIE_RX1+
A10	GBE0_MDI1+	B10	LPC_CLK	A65	PCIE_TX1-	B65	PCIE_RX1-
A11	GND (FIXED)	B11	GND (FIXED)	A66	GND	B66	WAKE0#
A12	GBE0_MDI0-	B12	PWRBTN#	A67	GPI2	B67	WAKE1#
A13	GBE0_MDI0+	B13	SMB_CK	A68	PCIE_TX0+	B68	PCIE_RX0+
A14	GBE0_CTREF	B14	SMB_DAT	A69	PCIE_TX0-	B69	PCIE_RX0-
A15	SUS_S3#	B15	SMB_ALERT#	A70	GND(FIXED)	B70	GND(FIXED)
A16	SATA0_TX+	B16	SATA1_TX+	A71	LVDS_A0+	B71	DDIO_PAIR0+
A17	SATA0_TX-	B17	SATA1_TX-	A72	LVDS_A0-	B72	DDIO_PAIR0-
A18	SUS_S4#	B18	SUS_STAT#	A73	LVDS_A1+	B73	DDIO_PAIR1+
A19	SATA0_RX+	B19	SATA1_RX+	A74	LVDS_A1-	B74	DDIO_PAIR1-
A20	SATA0_RX-	B20	SATA1_RX-	A75	LVDS_A2+	B75	DDIO_PAIR2+
A21	GND (FIXED)	B21	GND (FIXED)	A76	LVDS_A2-	B76	DDIO_PAIR2-
A22	USB_SSRX0-	B22	USB_SSTX0-	A77	LVDS_VDD_EN	B77	N.C.
A23	USB_SSRX0+	B23	USB_SSTX0+	A78	LVDS_A3+	B78	N.C.
A24	SUS_S5#	B24	PWR_OK	A79	LVDS_A3-	B79	LVDS_BKLT_EN
A25	N.C.	B25	N.C.	A80	GND(FIXED)	B80	GND(FIXED)
A26	N.C.	B26	N.C.	A81	LVDS_A_CK+	B81	DDIO_PAIR3+
A27	BATLOW#	B27	WDT	A82	LVDS_A_CK-	B82	DDIO_PAIR3-
A28	(S)ATA_ACT#	B28	N.C.	A83	LVDS_I2C_CK	B83	LVDS_BKLT_CTRL
A29	AC/HDA_SYNC	B29	AC/HDA_SDIN1	A84	LVDS_I2C_DAT	B84	VCC_5V_SBY
A30	AC/HDA_RST#	B30	AC/HDA_SDIN0	A85	GPI3	B85	VCC_5V_SBY
A31	GND (FIXED)	B31	GND (FIXED)	A86	N.C.	B86	VCC_5V_SBY
A32	AC/HDA_BITCLK	B32	SPKR	A87	N.C.	B87	VCC_5V_SBY
A33	AC/HDA_SDOOUT	B33	N.C.	A88	PCIE_CK_REF+	B88	N.C.
A34	N.C.	B34	N.C.	A89	PCIE_CK_REF-	B89	DDIO_HPD
A35	N.C.	B35	N.C.	A90	GND (FIXED)	B90	GND (FIXED)
A36	USB6-	B36	USB7-	A91	N.C.	B91	N.C.
A37	USB6+	B37	USB7+	A92	N.C.	B92	N.C.
A38	USB_6_7_OC#	B38	USB_4_5_OC#	A93	GPO0	B93	N.C.
A39	USB4-	B39	USB5-	A94	N.C.	B94	N.C.
A40	USB4+	B40	USB5+	A95	N.C.	B95	DDIO_DDC_AUX_SEL
A41	GND (FIXED)	B41	GND (FIXED)	A96	N.C.	B96	N.C.
A42	USB2-	B42	USB3-	A97	TYPE10#	B97	N.C.
A43	USB2+	B43	USB3+	A98	SER0_TX	B98	DDIO_CTRLCLK_AUX+
A44	USB_2_3_OC#	B44	USB_0_1_OC#	A99	SER0_RX	B99	DDIO_CTRLDATA_AUX-
A45	USB0-	B45	USB1-	A100	GND (FIXED)	B100	GND (FIXED)
A46	USB0+	B46	USB1+	A101	SER1_TX	B101	FAN_PWMOUT
A47	VCC_RTC	B47	N.C.	A102	SER1_RX	B102	FAN_TACHIN
A48	N.C.	B48	N.C.	A103	N.C.	B103	N.C.
A49	N.C.	B49	SYS_RESET#	A104	VCC_4.75-20V	B104	VCC_4.75-20V
A50	LPC_SERIRQ	B50	CB_RESET#	A105	VCC_4.75-20V	B105	VCC_4.75-20V
A51	GND (FIXED)	B51	GND (FIXED)	A106	VCC_4.75-20V	B106	VCC_4.75-20V
A52	N.C.	B52	N.C.	A107	VCC_4.75-20V	B107	VCC_4.75-20V
A53	N.C.	B53	N.C.	A108	VCC_4.75-20V	B108	VCC_4.75-20V
A54	GPI0	B54	GPO1	A109	VCC_4.75-20V	B109	VCC_4.75-20V
A55	N.C.	B55	N.C.	A110	GND (FIXED)	B110	GND (FIXED)

This page is intentionally left blank.

Chapter 3

Hardware Description

3.1 Microprocessor

The CEM846 supports Intel® Atom™ E3845/ E3827/ E3815 processors, which enables your system to operate under Windows® 7, Windows® 8 and Linux environments. The system performance depends on the microprocessor. You must install the heatsink or cooler carefully and properly to prevent damage.

3.2 BIOS

The CEM846 uses AMI Plug and Play BIOS with a single 16Mbit SPI Flash.









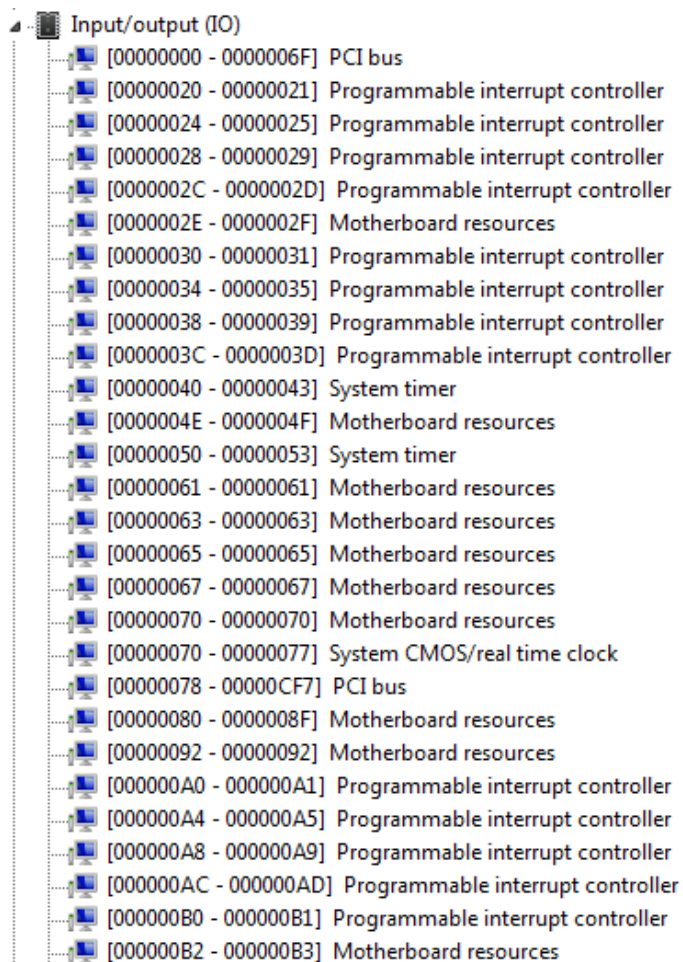



















3.3 System Memory

The CEM846 supports onboard DDR3L memory with maximum capacity up to 4GB.

3.4 I/O Port Address Map

The I/O port addresses (with CEB94008 baseboard under Windows® 7) are as follows:

































































































	[00000B4 - 00000B5] Programmable interrupt controller
	[00000B8 - 00000B9] Programmable interrupt controller
	[00000BC - 00000BD] Programmable interrupt controller
	[00000240 - 00000247] Communications Port (COM1)
	[00000248 - 0000024F] Communications Port (COM2)
	[00000250 - 00000257] Communications Port (COM3)
	[00000258 - 0000025F] Communications Port (COM4)
	[00000260 - 00000267] Communications Port (COM5)
	[00000268 - 0000026F] Communications Port (COM6)
	[000003B0 - 000003BB] Intel(R) Atom(TM) Processor E3800 Series/Intel(R) Celeron(R) Processor N2920/J1900
	[000003C0 - 000003DF] Intel(R) Atom(TM) Processor E3800 Series/Intel(R) Celeron(R) Processor N2920/J1900
	[00000400 - 0000047F] Motherboard resources
	[000004D0 - 000004D1] Programmable interrupt controller
	[00000500 - 000005FE] Motherboard resources
	[00000600 - 0000061F] Motherboard resources
	[00000680 - 0000069F] Motherboard resources
	[00000A00 - 00000A0F] Motherboard resources
	[00000A10 - 00000A1F] Motherboard resources
	[00000B00 - 00000B0F] Motherboard resources
	[00000D00 - 0000FFFF] PCI bus
	[0000C000 - 0000CFFF] Intel(R) Atom(TM)/Celeron(R)/Pentium(R) Processor PCI Express - Root Port 4 - 0F4E
	[0000D000 - 0000DFFF] Intel(R) Atom(TM)/Celeron(R)/Pentium(R) Processor PCI Express - Root Port 3 - 0F4C
	[0000E000 - 0000E01F] Intel(R) Atom(TM)/Celeron(R)/Pentium(R) Processor Platform Control Unit - SMBus Port - 0F12
	[0000E020 - 0000E03F] Intel(R) Atom(TM)/Celeron(R)/Pentium(R) Processor AHCI - 0F23
	[0000E040 - 0000E043] Intel(R) Atom(TM)/Celeron(R)/Pentium(R) Processor AHCI - 0F23
	[0000E050 - 0000E057] Intel(R) Atom(TM)/Celeron(R)/Pentium(R) Processor AHCI - 0F23
	[0000E060 - 0000E063] Intel(R) Atom(TM)/Celeron(R)/Pentium(R) Processor AHCI - 0F23
	[0000E070 - 0000E077] Intel(R) Atom(TM)/Celeron(R)/Pentium(R) Processor AHCI - 0F23
	[0000E080 - 0000E087] Intel(R) Atom(TM) Processor E3800 Series/Intel(R) Celeron(R) Processor N2920/J1900

3.5 Interrupt Controller (IRQ) Map

The interrupt controller (IRQ) mapping list (with CEB94008 baseboard under Windows® 7) is shown as follows:

IRQ	Device
(ISA) 0x00000000 (00)	System timer
(ISA) 0x00000007 (07)	Communications Port (COM1)
(ISA) 0x00000007 (07)	Communications Port (COM2)
(ISA) 0x00000007 (07)	Communications Port (COM3)
(ISA) 0x00000007 (07)	Communications Port (COM4)
(ISA) 0x00000007 (07)	Communications Port (COM5)
(ISA) 0x00000007 (07)	Communications Port (COM6)
(ISA) 0x00000008 (08)	High precision event timer
(ISA) 0x00000051 (81)	Microsoft ACPI-Compliant System
(ISA) 0x00000052 (82)	Microsoft ACPI-Compliant System
(ISA) 0x00000053 (83)	Microsoft ACPI-Compliant System
(ISA) 0x00000054 (84)	Microsoft ACPI-Compliant System
(ISA) 0x00000055 (85)	Microsoft ACPI-Compliant System
(ISA) 0x00000056 (86)	Microsoft ACPI-Compliant System
(ISA) 0x00000057 (87)	Microsoft ACPI-Compliant System
(ISA) 0x00000058 (88)	Microsoft ACPI-Compliant System
(ISA) 0x00000059 (89)	Microsoft ACPI-Compliant System
(ISA) 0x0000005A (90)	Microsoft ACPI-Compliant System
(ISA) 0x0000005B (91)	Microsoft ACPI-Compliant System
(ISA) 0x0000005C (92)	Microsoft ACPI-Compliant System
(ISA) 0x0000005D (93)	Microsoft ACPI-Compliant System
(ISA) 0x0000005E (94)	Microsoft ACPI-Compliant System
(ISA) 0x0000005F (95)	Microsoft ACPI-Compliant System
(ISA) 0x00000060 (96)	Microsoft ACPI-Compliant System
(ISA) 0x00000061 (97)	Microsoft ACPI-Compliant System
(ISA) 0x00000062 (98)	Microsoft ACPI-Compliant System
(ISA) 0x00000063 (99)	Microsoft ACPI-Compliant System
(ISA) 0x00000064 (100)	Microsoft ACPI-Compliant System
(ISA) 0x00000065 (101)	Microsoft ACPI-Compliant System
(ISA) 0x00000066 (102)	Microsoft ACPI-Compliant System
(ISA) 0x00000067 (103)	Microsoft ACPI-Compliant System
(ISA) 0x00000068 (104)	Microsoft ACPI-Compliant System
(ISA) 0x00000069 (105)	Microsoft ACPI-Compliant System
(ISA) 0x0000006A (106)	Microsoft ACPI-Compliant System
(ISA) 0x0000006B (107)	Microsoft ACPI-Compliant System
(ISA) 0x0000006C (108)	Microsoft ACPI-Compliant System
(ISA) 0x0000006D (109)	Microsoft ACPI-Compliant System
(ISA) 0x0000006E (110)	Microsoft ACPI-Compliant System
(ISA) 0x0000006F (111)	Microsoft ACPI-Compliant System
(ISA) 0x00000070 (112)	Microsoft ACPI-Compliant System
(ISA) 0x00000071 (113)	Microsoft ACPI-Compliant System
(ISA) 0x00000072 (114)	Microsoft ACPI-Compliant System
(ISA) 0x00000073 (115)	Microsoft ACPI-Compliant System
(ISA) 0x00000074 (116)	Microsoft ACPI-Compliant System
(ISA) 0x00000075 (117)	Microsoft ACPI-Compliant System

	(ISA) 0x00000076 (118)	Microsoft ACPI-Compliant System
	(ISA) 0x00000077 (119)	Microsoft ACPI-Compliant System
	(ISA) 0x00000078 (120)	Microsoft ACPI-Compliant System
	(ISA) 0x00000079 (121)	Microsoft ACPI-Compliant System
	(ISA) 0x0000007A (122)	Microsoft ACPI-Compliant System
	(ISA) 0x0000007B (123)	Microsoft ACPI-Compliant System
	(ISA) 0x0000007C (124)	Microsoft ACPI-Compliant System
	(ISA) 0x0000007D (125)	Microsoft ACPI-Compliant System
	(ISA) 0x0000007E (126)	Microsoft ACPI-Compliant System
	(ISA) 0x0000007F (127)	Microsoft ACPI-Compliant System
	(ISA) 0x00000080 (128)	Microsoft ACPI-Compliant System
	(ISA) 0x00000081 (129)	Microsoft ACPI-Compliant System
	(ISA) 0x00000082 (130)	Microsoft ACPI-Compliant System
	(ISA) 0x00000083 (131)	Microsoft ACPI-Compliant System
	(ISA) 0x00000084 (132)	Microsoft ACPI-Compliant System
	(ISA) 0x00000085 (133)	Microsoft ACPI-Compliant System
	(ISA) 0x00000086 (134)	Microsoft ACPI-Compliant System
	(ISA) 0x00000087 (135)	Microsoft ACPI-Compliant System
	(ISA) 0x00000088 (136)	Microsoft ACPI-Compliant System
	(ISA) 0x00000089 (137)	Microsoft ACPI-Compliant System
	(ISA) 0x0000008A (138)	Microsoft ACPI-Compliant System
	(ISA) 0x0000008B (139)	Microsoft ACPI-Compliant System
	(ISA) 0x0000008C (140)	Microsoft ACPI-Compliant System
	(ISA) 0x0000008D (141)	Microsoft ACPI-Compliant System
	(ISA) 0x0000008E (142)	Microsoft ACPI-Compliant System
	(ISA) 0x0000008F (143)	Microsoft ACPI-Compliant System
	(ISA) 0x00000090 (144)	Microsoft ACPI-Compliant System
	(ISA) 0x00000091 (145)	Microsoft ACPI-Compliant System
	(ISA) 0x00000092 (146)	Microsoft ACPI-Compliant System
	(ISA) 0x00000093 (147)	Microsoft ACPI-Compliant System
	(ISA) 0x00000094 (148)	Microsoft ACPI-Compliant System
	(ISA) 0x00000095 (149)	Microsoft ACPI-Compliant System
	(ISA) 0x00000096 (150)	Microsoft ACPI-Compliant System
	(ISA) 0x00000097 (151)	Microsoft ACPI-Compliant System
	(ISA) 0x00000098 (152)	Microsoft ACPI-Compliant System
	(ISA) 0x00000099 (153)	Microsoft ACPI-Compliant System
	(ISA) 0x0000009A (154)	Microsoft ACPI-Compliant System
	(ISA) 0x0000009B (155)	Microsoft ACPI-Compliant System
	(ISA) 0x0000009C (156)	Microsoft ACPI-Compliant System
	(ISA) 0x0000009D (157)	Microsoft ACPI-Compliant System
	(ISA) 0x0000009E (158)	Microsoft ACPI-Compliant System
	(ISA) 0x0000009F (159)	Microsoft ACPI-Compliant System
	(ISA) 0x000000A0 (160)	Microsoft ACPI-Compliant System
	(ISA) 0x000000A1 (161)	Microsoft ACPI-Compliant System
	(ISA) 0x000000A2 (162)	Microsoft ACPI-Compliant System
	(ISA) 0x000000A3 (163)	Microsoft ACPI-Compliant System
	(ISA) 0x000000A4 (164)	Microsoft ACPI-Compliant System

	(ISA) 0x000000A5 (165)	Microsoft ACPI-Compliant System
	(ISA) 0x000000A6 (166)	Microsoft ACPI-Compliant System
	(ISA) 0x000000A7 (167)	Microsoft ACPI-Compliant System
	(ISA) 0x000000A8 (168)	Microsoft ACPI-Compliant System
	(ISA) 0x000000A9 (169)	Microsoft ACPI-Compliant System
	(ISA) 0x000000AA (170)	Microsoft ACPI-Compliant System
	(ISA) 0x000000AB (171)	Microsoft ACPI-Compliant System
	(ISA) 0x000000AC (172)	Microsoft ACPI-Compliant System
	(ISA) 0x000000AD (173)	Microsoft ACPI-Compliant System
	(ISA) 0x000000AE (174)	Microsoft ACPI-Compliant System
	(ISA) 0x000000AF (175)	Microsoft ACPI-Compliant System
	(ISA) 0x000000B0 (176)	Microsoft ACPI-Compliant System
	(ISA) 0x000000B1 (177)	Microsoft ACPI-Compliant System
	(ISA) 0x000000B2 (178)	Microsoft ACPI-Compliant System
	(ISA) 0x000000B3 (179)	Microsoft ACPI-Compliant System
	(ISA) 0x000000B4 (180)	Microsoft ACPI-Compliant System
	(ISA) 0x000000B5 (181)	Microsoft ACPI-Compliant System
	(ISA) 0x000000B6 (182)	Microsoft ACPI-Compliant System
	(ISA) 0x000000B7 (183)	Microsoft ACPI-Compliant System
	(ISA) 0x000000B8 (184)	Microsoft ACPI-Compliant System
	(ISA) 0x000000B9 (185)	Microsoft ACPI-Compliant System
	(ISA) 0x000000BA (186)	Microsoft ACPI-Compliant System
	(ISA) 0x000000BB (187)	Microsoft ACPI-Compliant System
	(ISA) 0x000000BC (188)	Microsoft ACPI-Compliant System
	(ISA) 0x000000BD (189)	Microsoft ACPI-Compliant System
	(ISA) 0x000000BE (190)	Microsoft ACPI-Compliant System
	(PCI) 0x00000003 (03)	Intel(R) Atom(TM)/Celeron(R)/Pentium(R) Processor Trusted Execution Engine Interface - 0F18
	(PCI) 0x0000000A (10)	Intel(R) Atom(TM)/Celeron(R)/Pentium(R) Processor Platform Control Unit - SMBus Port - 0F12
	(PCI) 0x00000010 (16)	Intel(R) Atom(TM)/Celeron(R)/Pentium(R) Processor PCI Express - Root Port 1 - 0F48
	(PCI) 0x00000011 (17)	Intel(R) Atom(TM)/Celeron(R)/Pentium(R) Processor PCI Express - Root Port 2 - 0F4A
	(PCI) 0x00000012 (18)	Intel(R) Atom(TM)/Celeron(R)/Pentium(R) Processor PCI Express - Root Port 3 - 0F4C
	(PCI) 0x00000013 (19)	Intel(R) Atom(TM)/Celeron(R)/Pentium(R) Processor AHCI - 0F23
	(PCI) 0x00000013 (19)	Intel(R) Atom(TM)/Celeron(R)/Pentium(R) Processor PCI Express - Root Port 4 - 0F4E
	(PCI) 0x00000016 (22)	High Definition Audio Controller
	(PCI) 0xFFFFFFFF1 (-15)	Intel(R) I210 Gigabit Network Connection #2
	(PCI) 0xFFFFFFFF2 (-14)	Intel(R) I210 Gigabit Network Connection #2
	(PCI) 0xFFFFFFFF3 (-13)	Intel(R) I210 Gigabit Network Connection #2
	(PCI) 0xFFFFFFFF4 (-12)	Intel(R) I210 Gigabit Network Connection #2
	(PCI) 0xFFFFFFFF5 (-11)	Intel(R) I210 Gigabit Network Connection #2
	(PCI) 0xFFFFFFFF6 (-10)	Intel(R) I210 Gigabit Network Connection #2
	(PCI) 0xFFFFFFFF7 (-9)	Intel(R) I210 Gigabit Network Connection
	(PCI) 0xFFFFFFFF8 (-8)	Intel(R) I210 Gigabit Network Connection
	(PCI) 0xFFFFFFFF9 (-7)	Intel(R) I210 Gigabit Network Connection
	(PCI) 0xFFFFFFFFFA (-6)	Intel(R) I210 Gigabit Network Connection
	(PCI) 0xFFFFFFFFFB (-5)	Intel(R) I210 Gigabit Network Connection
	(PCI) 0xFFFFFFFFFC (-4)	Intel(R) I210 Gigabit Network Connection
	(PCI) 0xFFFFFFFFFD (-3)	Intel(R) USB 3.0 eXtensible Host Controller
	(PCI) 0xFFFFFFFFFE (-2)	Intel(R) Atom(TM) Processor E3800 Series/Intel(R) Celeron(R) Processor N2920/J1900

3.6 Memory Map

The memory (with CEB94008 baseboard under Windows® 7) mapping list is shown as follows:

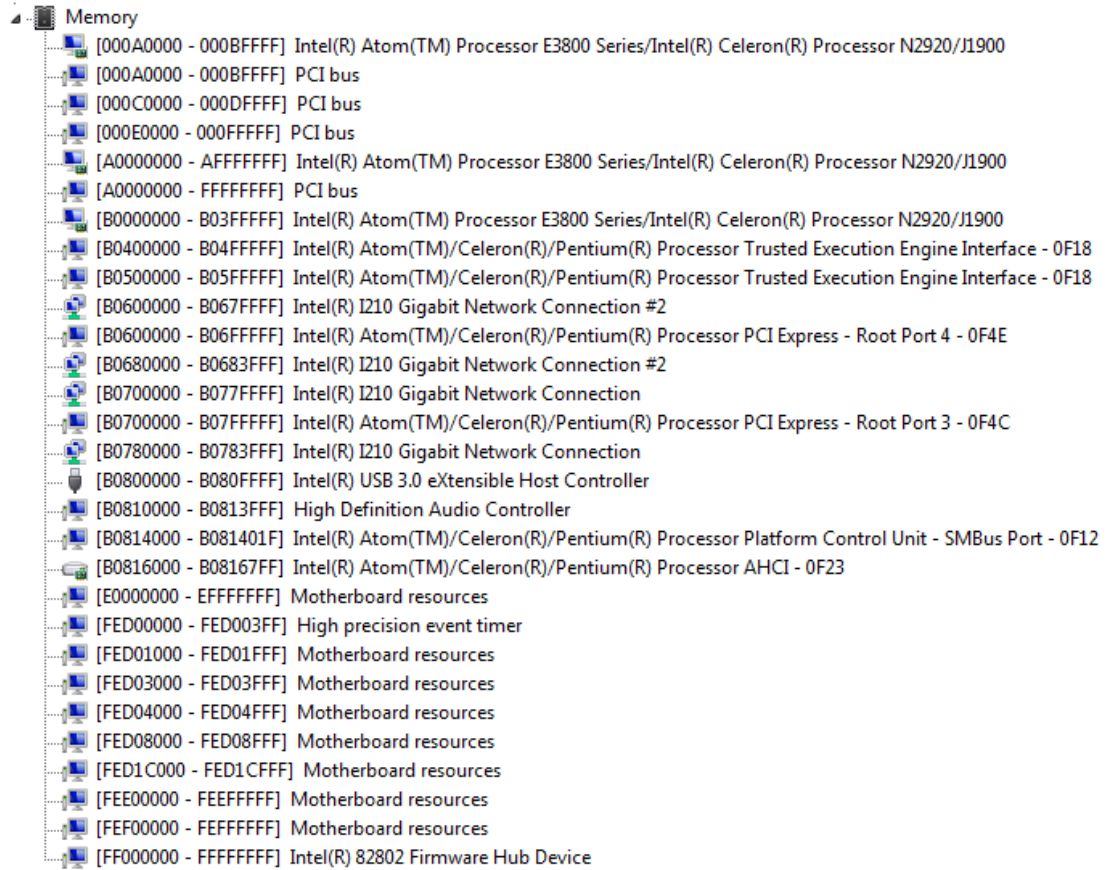

This page is intentionally left blank.

Chapter 4

AMI BIOS Setup Utility

The AMI UEFI BIOS provides users with a built-in setup program to modify basic system configuration. All configured parameters are stored in a flash chip to save the setup information whenever the power is turned off. This chapter provides users with detailed description about how to set up basic system configuration through the AMI BIOS setup utility.

4.1 Starting

To enter the setup screens, follow the steps below:

1. Turn on the computer and press the key immediately.
2. After you press the key, the main BIOS setup menu displays. You can access the other setup screens from the main BIOS setup menu, such as the Advanced and Chipset menus.



Note

If your computer cannot boot after making and saving system changes with BIOS setup, you can restore BIOS optimal defaults by setting SW1-2 (see section 2.4.1).

It is strongly recommended that you should avoid changing the chipset's defaults. Both AMI and your system manufacturer have carefully set up these defaults that provide the best performance and reliability.

4.2 Navigation Keys

The BIOS setup/utility uses a key-based navigation system called hot keys. Most of the BIOS setup utility hot keys can be used at any time during the setup navigation process. These keys include <F1>, <F2>, <Enter>, <ESC>, <Arrow> keys, and so on.



Note

Some of the navigation keys differ from one screen to another.

Hot Keys	Description
→← Left/Right	The Left and Right <Arrow> keys allow you to select a setup screen.
↑↓ Up/Down	The Up and Down <Arrow> keys allow you to select a setup screen or sub screen.
+– Plus/Minus	The Plus and Minus <Arrow> keys allow you to change the field value of a particular setup item.
Tab	The <Tab> key allows you to select setup fields.
F1	The <F1> key allows you to display the General Help screen.
F2	The <F2> key allows you to Load Previous Values.
F3	The <F3> key allows you to Load Optimized Defaults.
F4	The <F4> key allows you to save any changes you have made and exit Setup. Press the <F4> key to save your changes.
Esc	The <Esc> key allows you to discard any changes you have made and exit the Setup. Press the <Esc> key to exit the setup without saving your changes.
Enter	The <Enter> key allows you to display or change the setup option listed for a particular setup item. The <Enter> key can also allow you to display the setup sub screens.

4.3 Main Menu

When you first enter the setup utility, you will enter the Main setup screen. You can always return to the Main setup screen by selecting the Main tab. System Time/Date can be set up as described below. The Main BIOS setup screen is shown below.

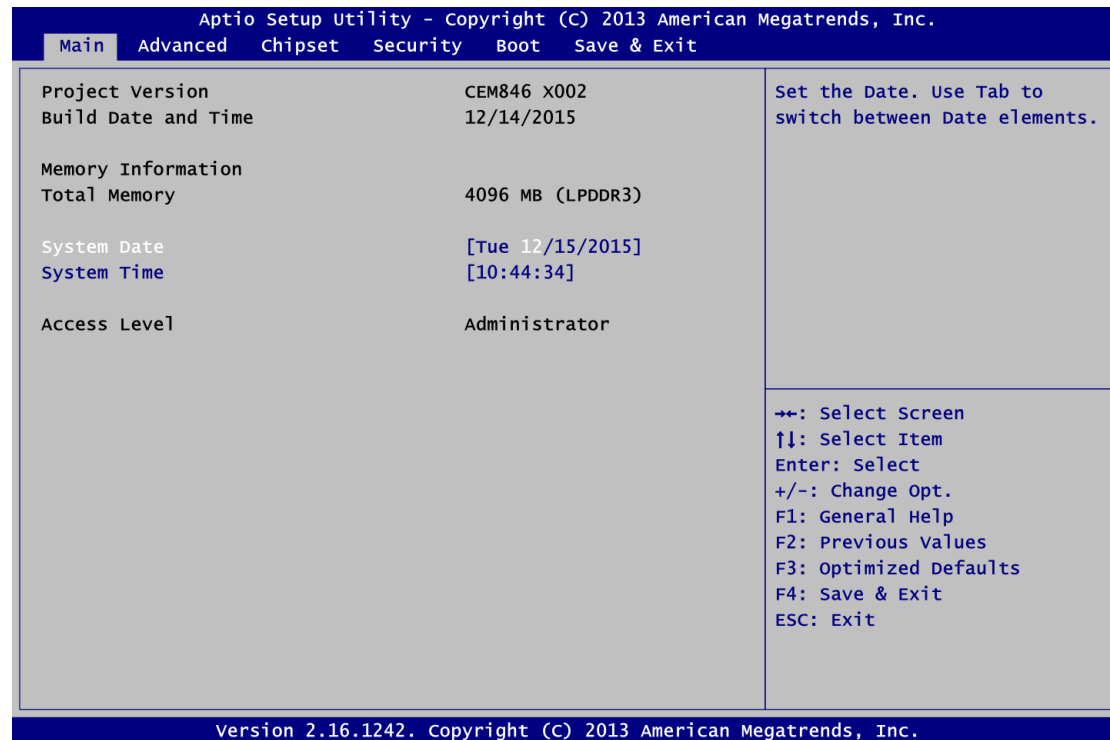

BIOS and Memory Information

Display BIOS and memory information.

System Date/Time

Use this option to change the system time and date. Highlight System Time or System Date using the <Arrow> keys. Enter new values through the keyboard. Press the <Tab> key or the <Arrow> keys to move between fields. The date must be entered in MM/DD/YY format. The time is entered in HH:MM:SS format.

Access Level

Display the access level of current user.

4.4 Advanced Menu

The Advanced menu also allows users to set configuration of the CPU and other system devices. You can select any of the items in the left frame of the screen to go to the sub menus:

- ▶ ACPI Settings
- ▶ F81801 Super IO Configuration
- ▶ Hardware Monitor
- ▶ Serial Port Console Redirection
- ▶ CPU Configuration
- ▶ IDE Configuration
- ▶ Utility Configuration

For items marked with “▶”, please press <Enter> for more options.

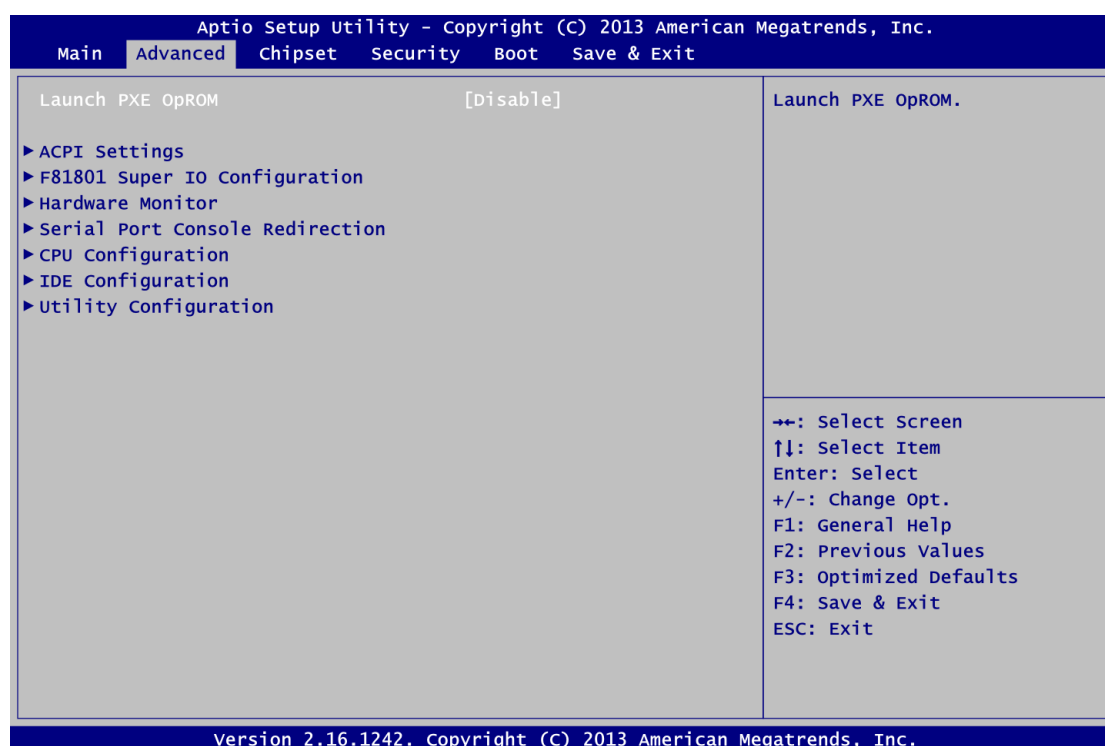

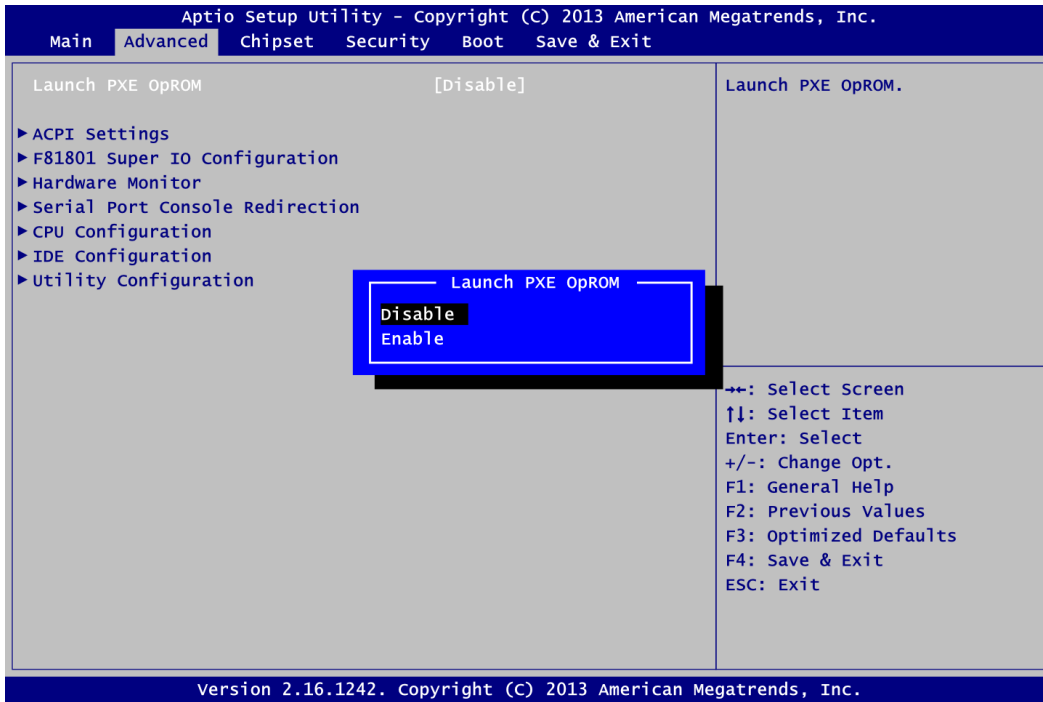

Launch PXE OpROM

Enable or disable the Preboot eXecution Environment (PXE) boot ROM function of the LAN chip when the system boots up.

- **ACPI Settings**

You can use this screen to select options for the ACPI configuration, and change the value of the selected option. A description of the selected item appears on the right side of the screen.

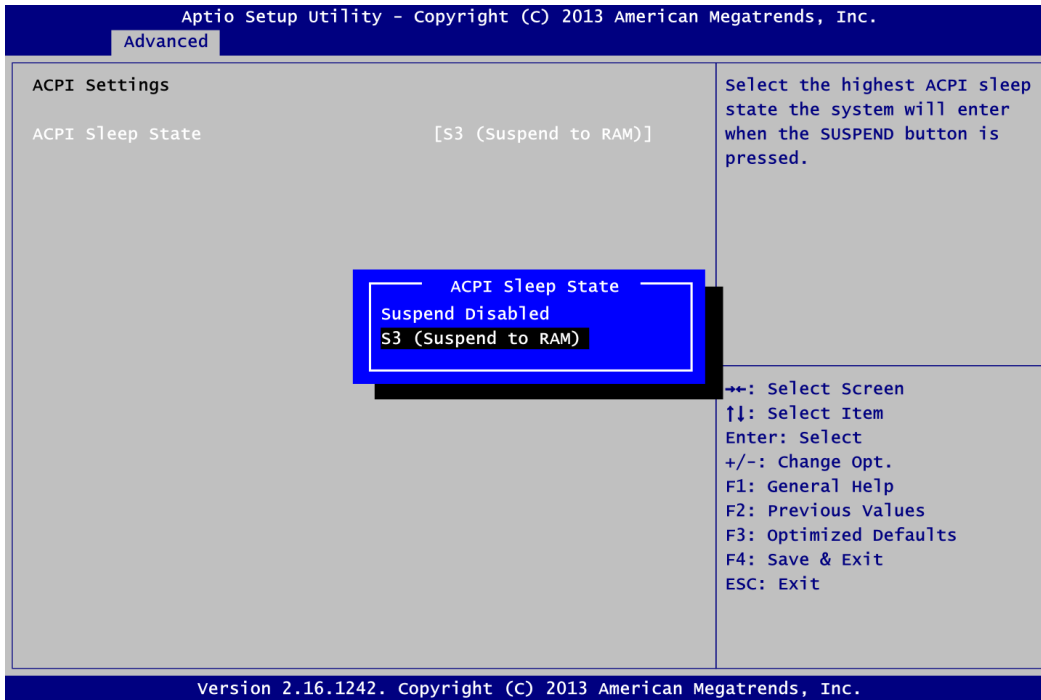

ACPI Sleep State

Select the ACPI (Advanced Configuration and Power Interface) sleep state. Configuration options are Suspend Disabled and S3 (Suspend to RAM). The S3 (Suspend to RAM) option selects ACPI sleep state the system will enter when suspend button is pressed.

- **F81801 Super IO Configuration**

You can use this screen to select options for the Second Super IO Configuration, and change the value of the selected option. A description of the selected item appears on the right side of the screen. For items marked with "▶", please press <Enter> for more options.

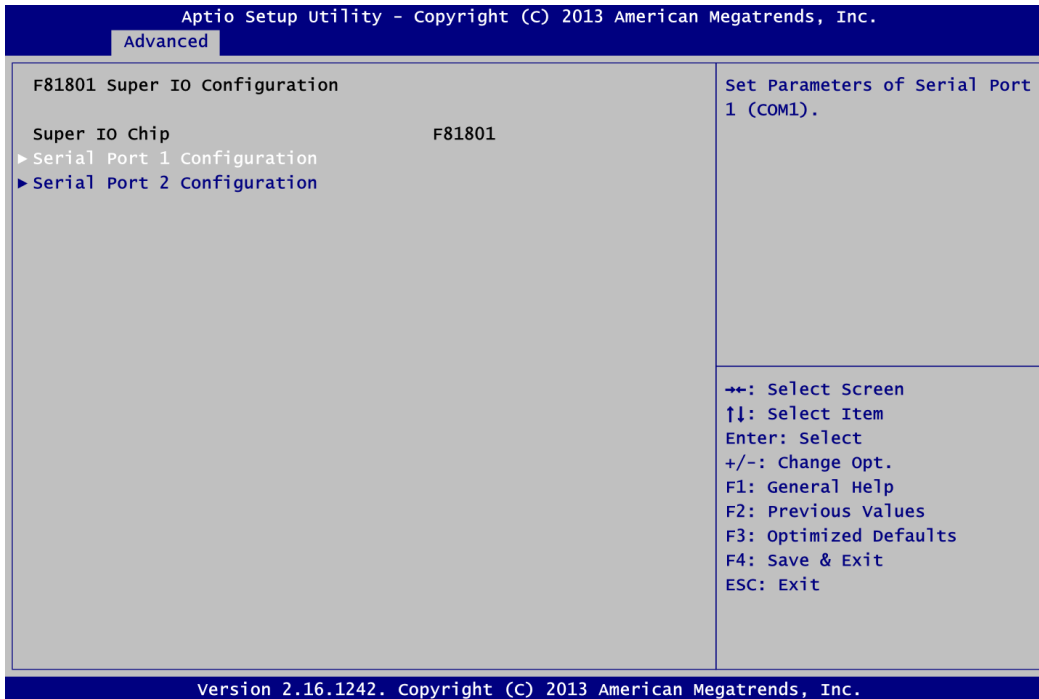

Serial Port 1 ~ 2 Configuration

Set parameters of serial port 1 ~ 2.

- **Serial Port 1 Configuration**

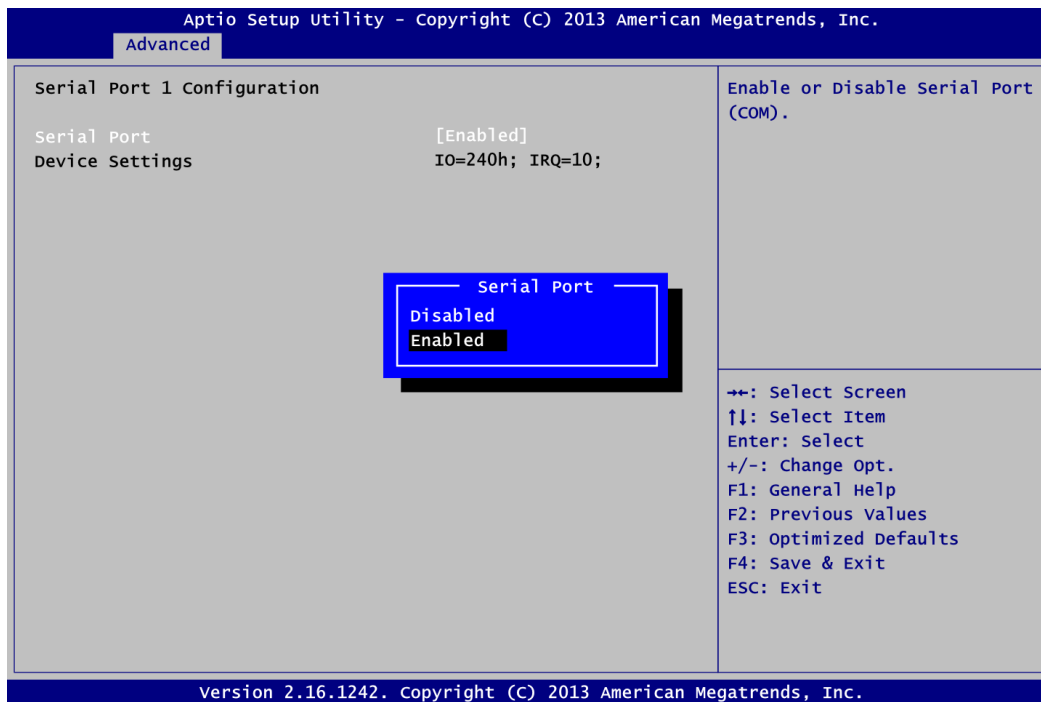

Serial Port

Enable or disable serial port 1. The optimal setting for base I/O address is 240h and for interrupt request address is IRQ10.

- **Hardware Monitor**

This screen is for fan speed control and hardware health status monitoring.

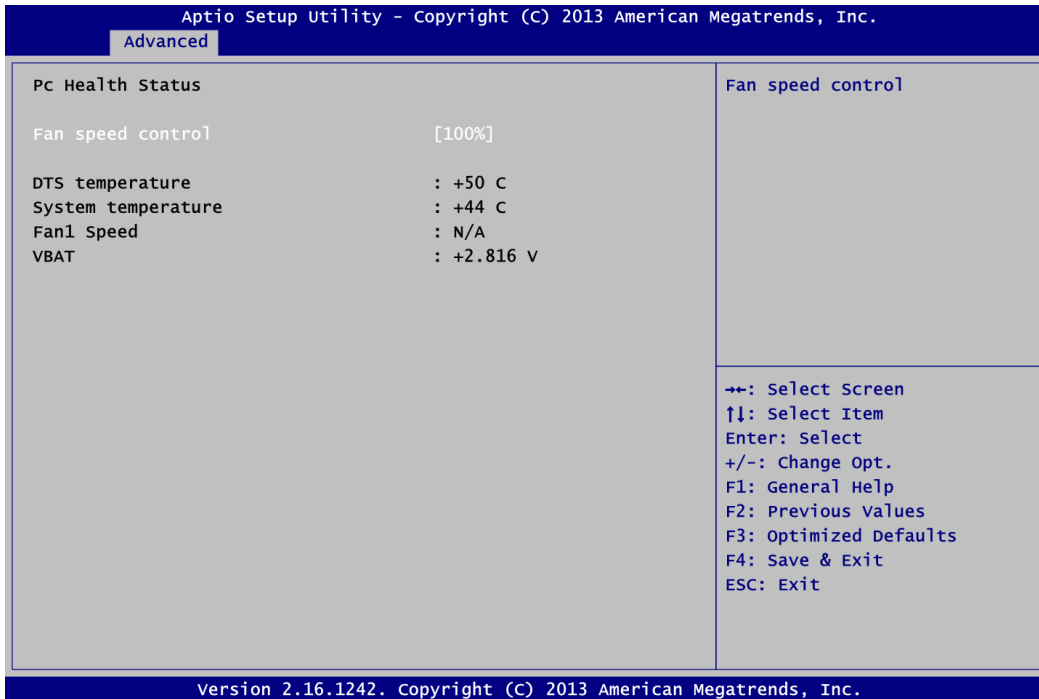

This screen displays the temperature of system and CPU, cooling fan speed in RPM and VBAT voltage.

Fan Speed Control

This item is for adjusting fan speed.

- **Serial Port Console Redirection**

You can use this screen to select options for Serial Port Console Redirection, and change the value of the selected option. A description of the selected item appears on the right side of the screen. For items marked with “▶”, please press <Enter> for more options.

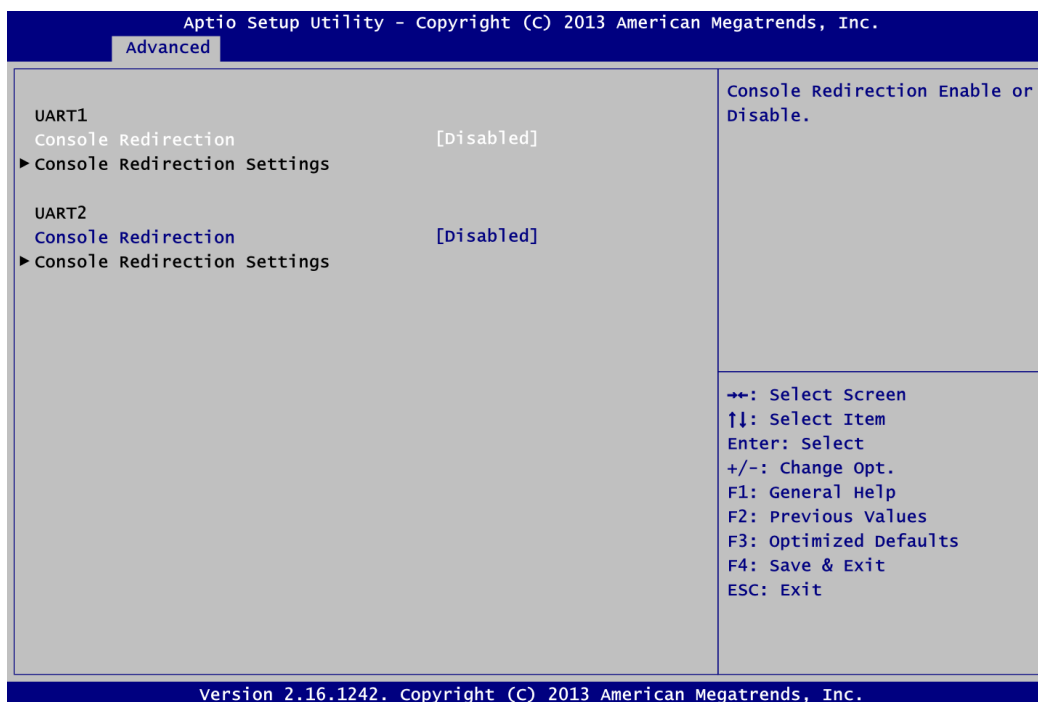

UART1\UART2 Console Redirection

Enable or disable UART1\UART2 console redirection.

UART1\UART2 Console Redirection Settings

Specify how the host computer and the remote computer (which the user is using) will exchange data. Both computers should have the same or compatible settings. Open sub menu for parameters related to graphics configuration.

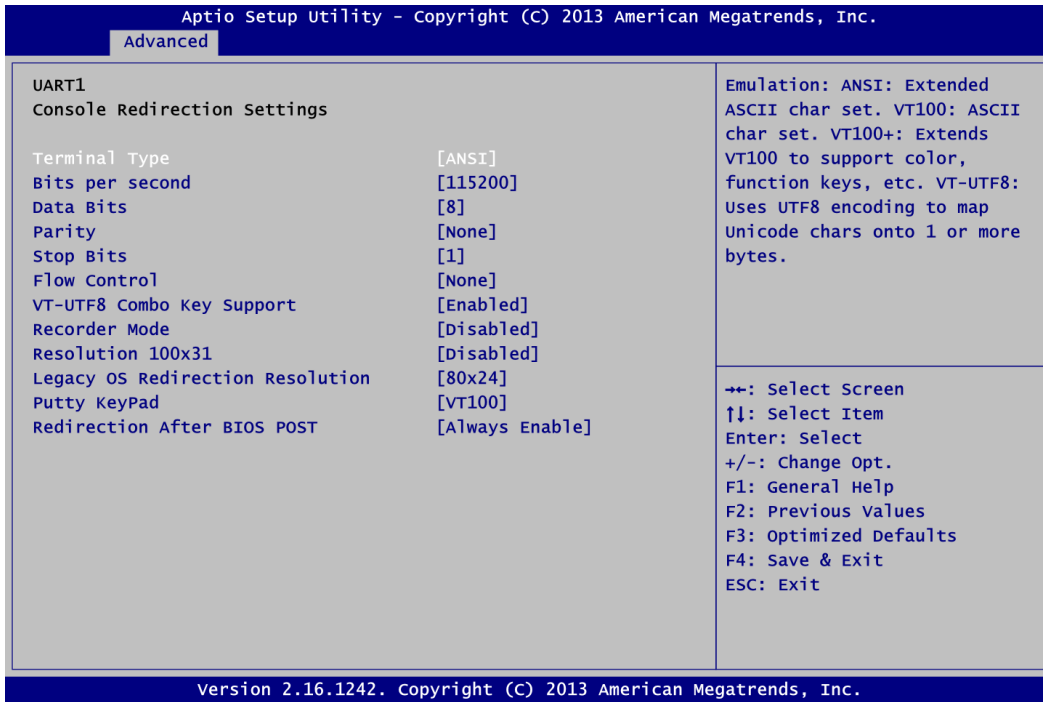

You can use this screen to set parameters for console redirection settings.

- **CPU Configuration**

This screen shows the CPU Configuration, and you can change the value of the selected option.

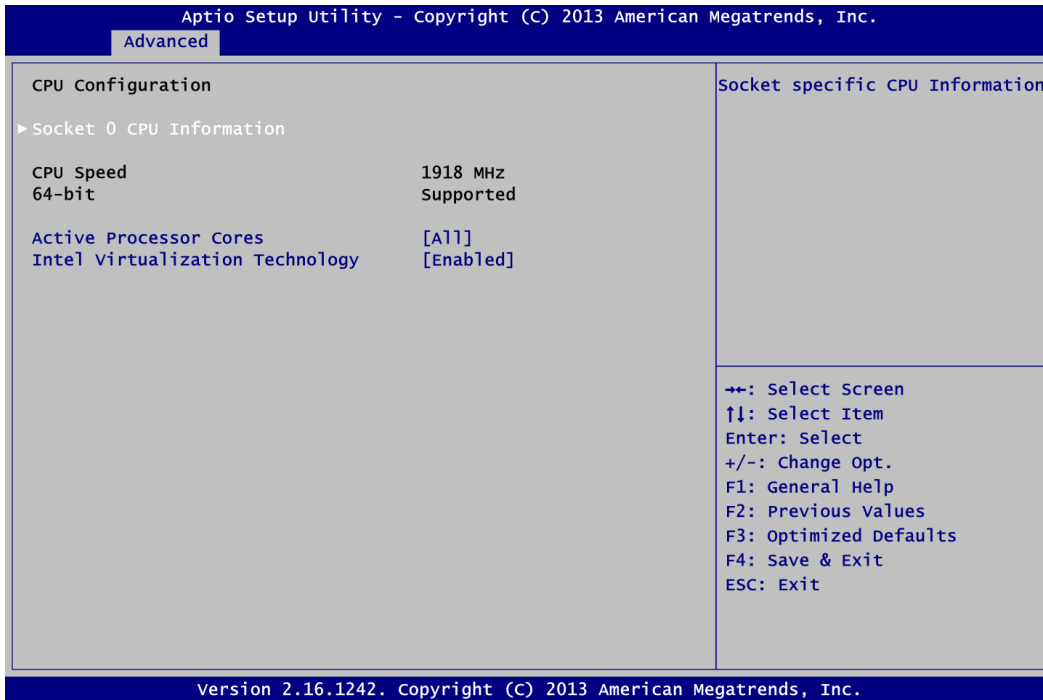

Socket 0 CPU Information

Show CPU information.

Active Processor Cores

Select the number of processor cores to be active.

Intel Virtualization Technology

Enable or disable Intel Virtualization Technology. When enabled, a VMM can utilize the additional hardware capabilities. It allows a platform to run multiple operating systems and applications independently, hence enabling a computer system to work as several virtual systems.

- **IDE Configuration**

In the IDE Configuration menu, you can see the currently installed hardware in the SATA ports. During system boot up, the BIOS automatically detects the presence of SATA devices.

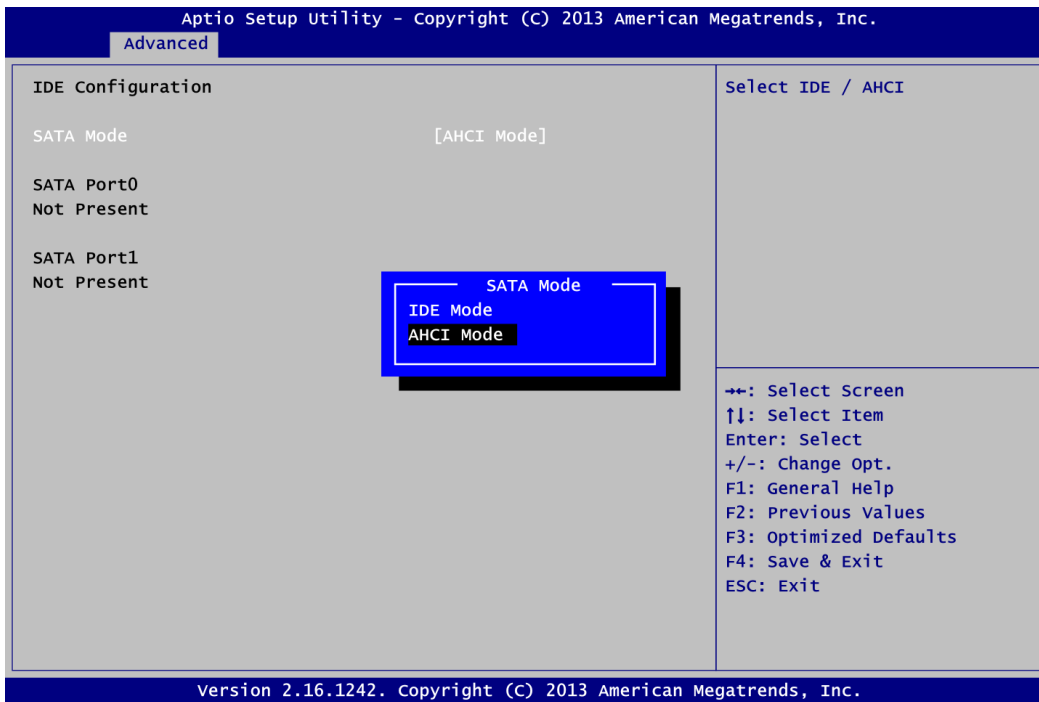
**SATA Mode**

Determine how SATA controller(s) operate. Operation modes are IDE Mode and AHCI Mode.

- **Utility Configuration**

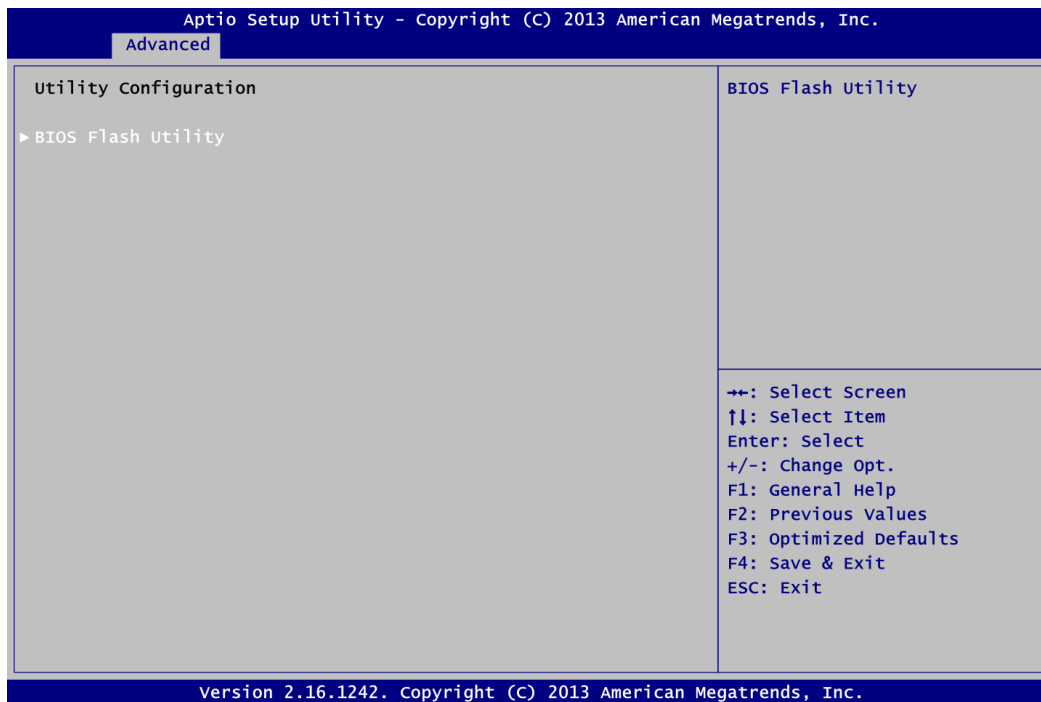

BIOS Flash Utility

BIOS flash utility configuration. For more detailed information, please refer to Appendix C.

4.5 Chipset Menu

The Chipset menu allows users to change the advanced chipset settings. You can select any of the items in the left frame of the screen to go to the sub menus:

- ▶ North Bridge
- ▶ South Bridge

For items marked with “▶”, please press <Enter> for more options.

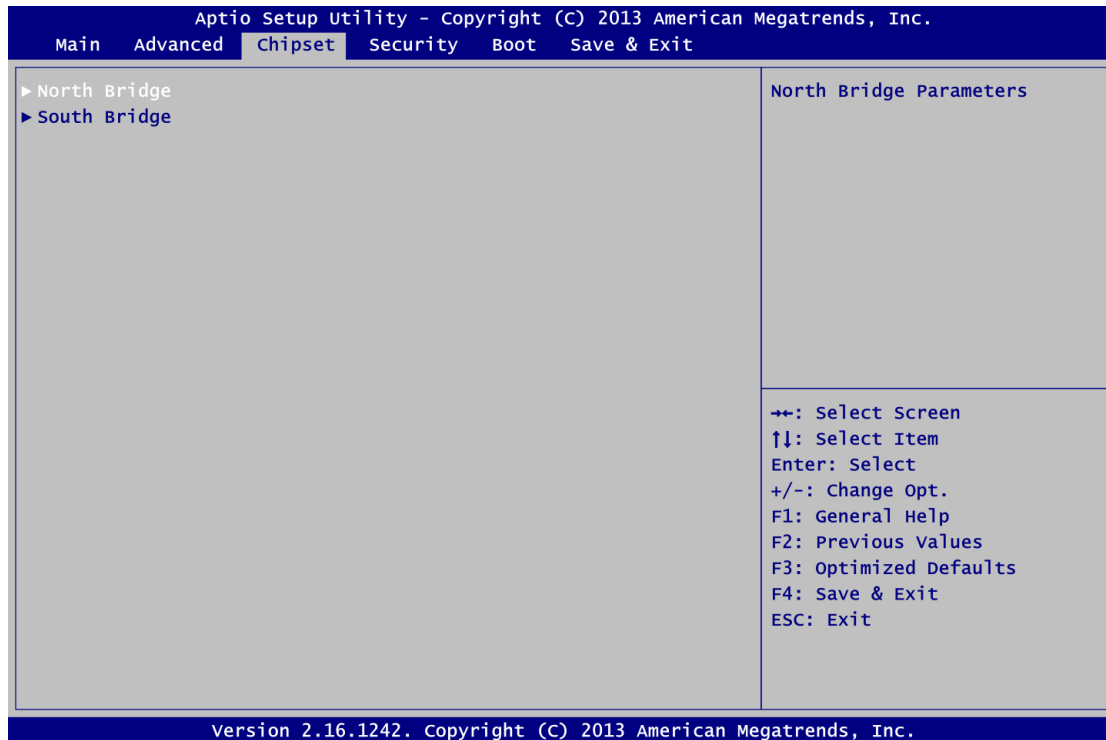

● IGD – LCD Control

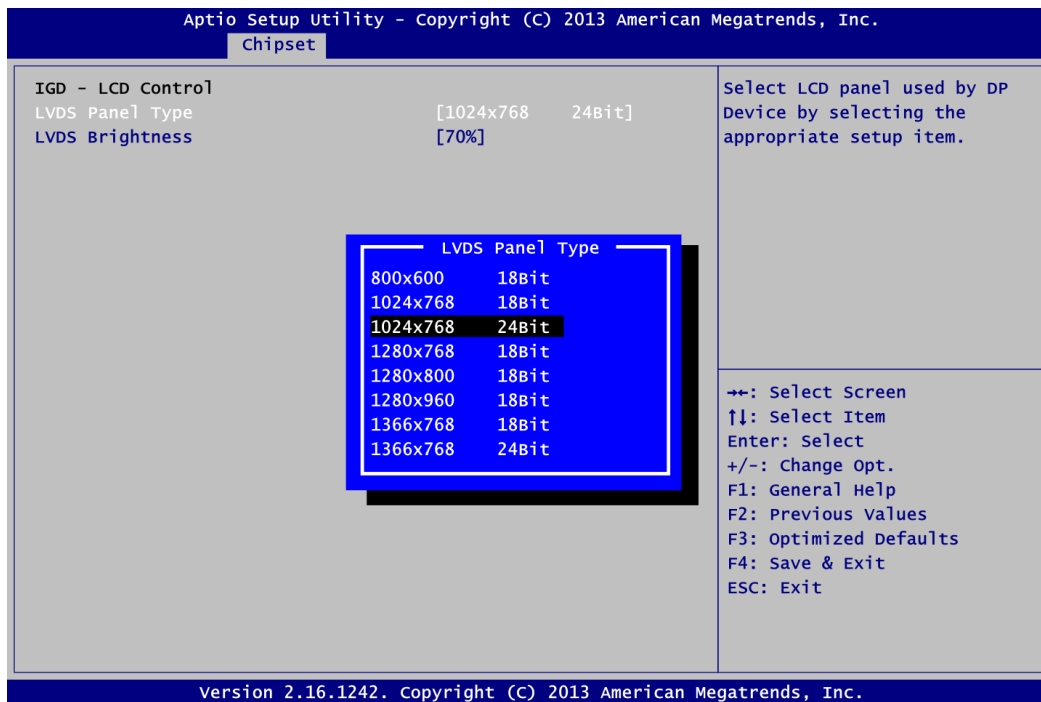

LVDS Panel Type

Select LVDS panel resolution.

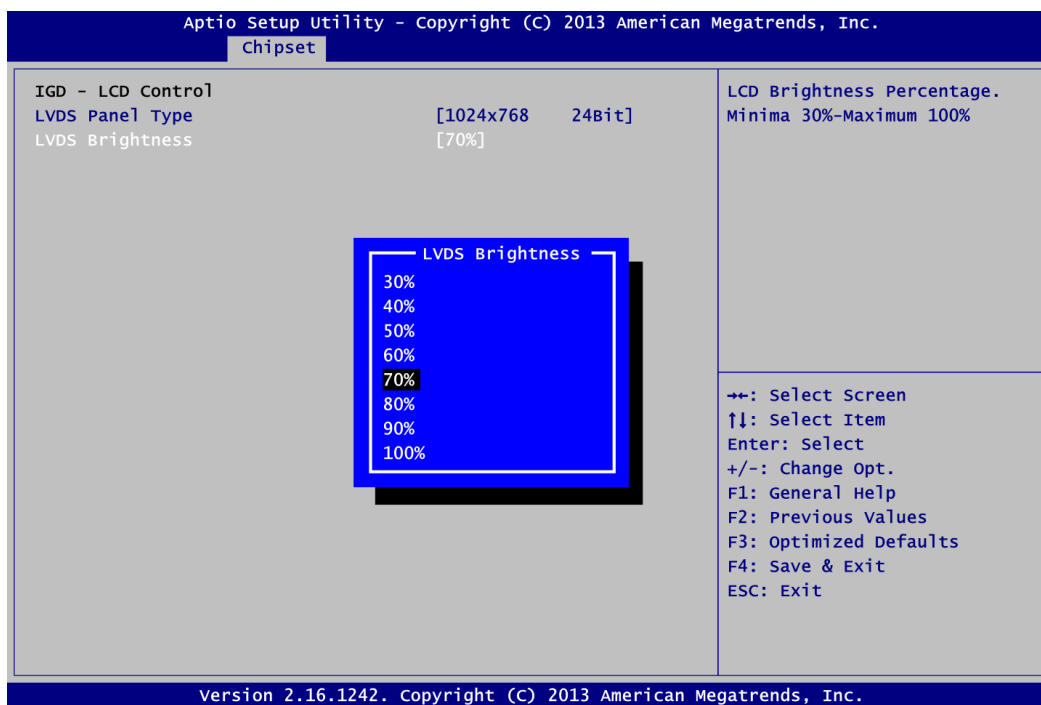

LVDS Brightness

Select the brightness of LVDS panel ranging from 30% to 100%. The default setting is 70%.

- **USB Configuration**

You can use this screen to select options for the USB Configuration, and change the value of the selected option. A description of the selected item appears on the right side of the screen.

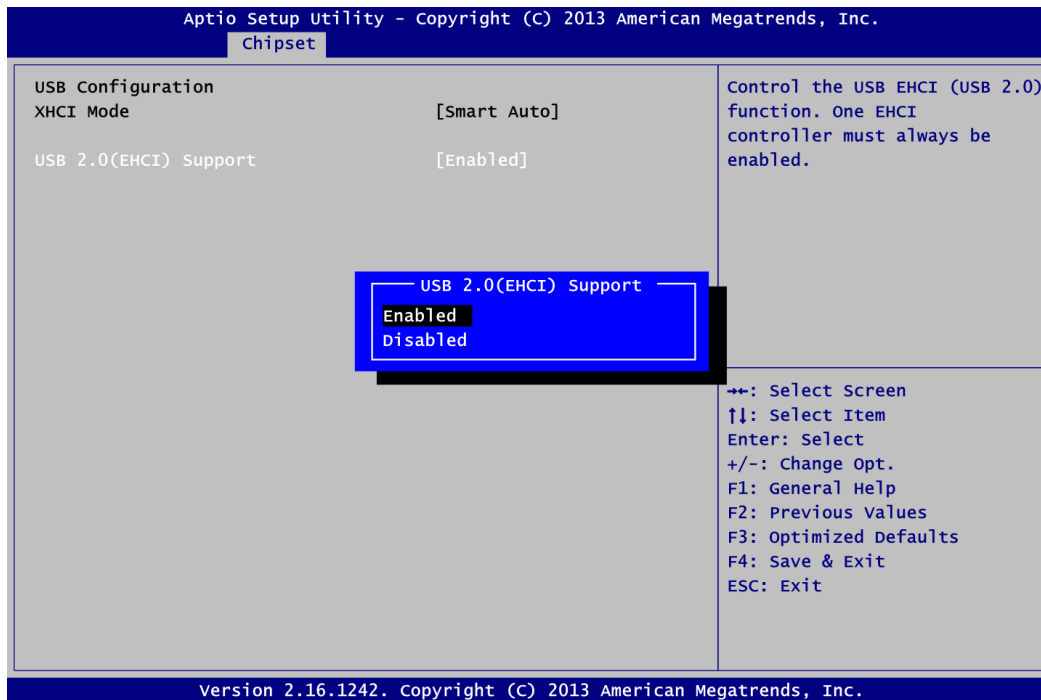

XHCI Mode

Smart auto option will auto detect the suitable mode for device plugged.

USB 2.0(EHCI) Support

Enable and disable USB 2.0 (EHCI) function.



Note

In order for the USB 2.0 port 4~7 and USB 3.0 function to work properly in Windows® 7, please install USB 3.0 XHCI driver in advanced. After installing the XHCI driver, the system will auto detect the suitable mode for the plugged device.

4.6 Security Menu

The Security menu allows users to change the security settings for the system.

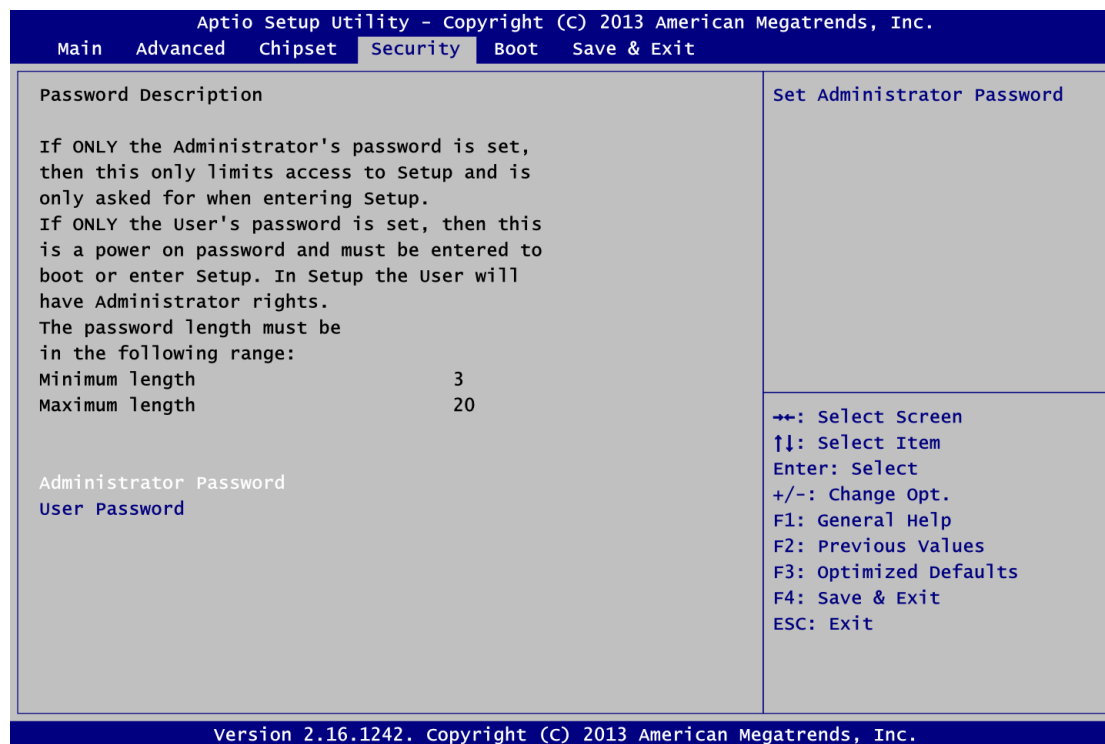

- **Administrator Password**
Set administrator password.
- **User Password**
Set user password.

4.7 Boot Menu

The Boot menu allows users to change boot options of the system.

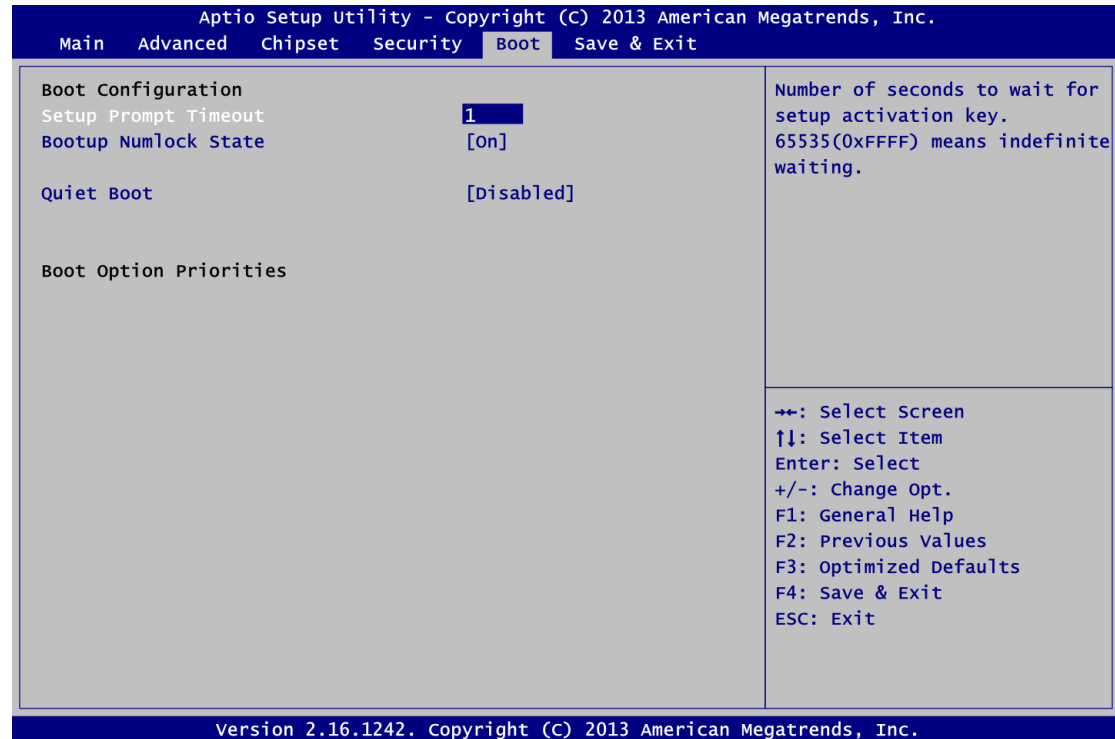

- Setup Prompt Timeout**
 Number of seconds to wait for setup activation key. 65535(0xFFFF) means indefinite waiting.
- Bootup NumLock State**
 Use this item to select the power-on state for the keyboard NumLock.
- Quiet Boot**
 Select to display either POST output messages or a splash screen during boot-up.
- Boot Option Priorities**
 These are settings for boot priority. Specify the boot device priority sequence from the available devices.

4.8 Save & Exit Menu

The Save & Exit menu allows users to load your system configuration with optimal or fail-safe default values.

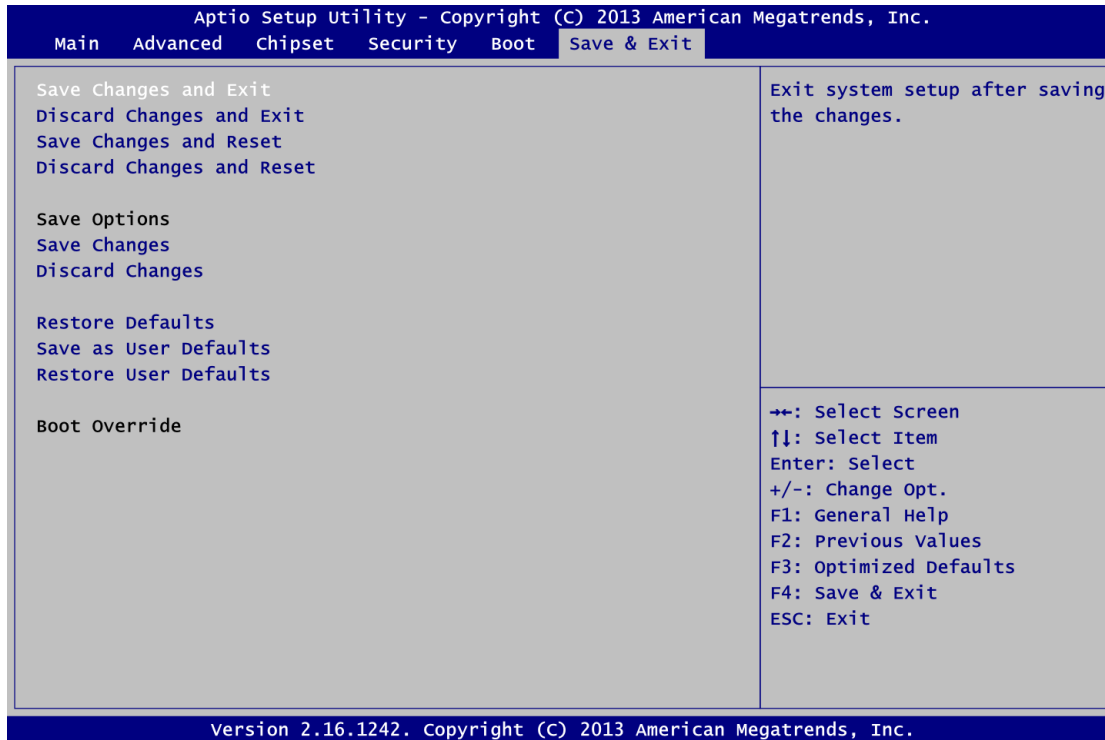

- Save Changes and Exit**
When you have completed the system configuration changes, select this option to leave Setup and return to Main Menu. Select Save Changes and Exit from the Save & Exit menu and press <Enter>. Select Yes to save changes and exit.
- Discard Changes and Exit**
Select this option to quit Setup without making any permanent changes to the system configuration and return to Main Menu. Select Discard Changes and Exit from the Save & Exit menu and press <Enter>. Select Yes to discard changes and exit.
- Save Changes and Reset**
When you have completed the system configuration changes, select this option to leave Setup and reboot the computer so the new system configuration parameters can take effect. Select Save Changes and Reset from the Save & Exit menu and press <Enter>. Select Yes to save changes and reset.
- Discard Changes and Reset**
Select this option to quit Setup without making any permanent changes to the system configuration and reboot the computer. Select Discard Changes and Reset from the Save & Exit menu and press <Enter>. Select Yes to discard changes and reset.
- Save Changes**
When you have completed the system configuration changes, select this option to save changes. Select Save Changes from the Save & Exit menu and press <Enter>. Select Yes to save changes.

- **Discard Changes**
Select this option to quit Setup without making any permanent changes to the system configuration. Select Discard Changes from the Save & Exit menu and press <Enter>. Select Yes to discard changes.
- **Restore Defaults**
It automatically sets all Setup options to a complete set of default settings when you select this option. Select Restore Defaults from the Save & Exit menu and press <Enter>.
- **Save as User Defaults**
Select this option to save system configuration changes done so far as User Defaults. Select Save as User Defaults from the Save & Exit menu and press <Enter>.
- **Restore User Defaults**
It automatically sets all Setup options to a complete set of User Defaults when you select this option. Select Restore User Defaults from the Save & Exit menu and press <Enter>.
- **Boot Override**
Select boot device regardless of the current boot priority order.

This page is intentionally left blank.

Appendix A

Watchdog Timer

A.1 About Watchdog Timer

After the system stops working for a while, it can be auto-reset by the watchdog timer. The integrated watchdog timer can be set up in the system reset mode by program.

A.2 How to Use Watchdog Timer

Start

↓

Enable configuration:

-O 2E 87

-O 2E 87

↓

Select watchdog timer device:

-O 2E 07

-O 2F 07

↓

Enable WDT:

-O 2E 30

-O 2F 01

↓

Activate WDT:

-O 2E F0

-O 2F 80

↓

Set base timer:

-O 2E F6

-O 2F 0A ; Set reset time (where A (hex) = 10sec)

↓

Set timer unit (second or minute):

-O 2E F5

-O 2F 71 ; Set timer unit
; (1: timer unit=second; 9: timer unit=minute)

This page is intentionally left blank.

Appendix B

Digital I/O

B.1 About Digital I/O

The onboard GPIO (digital I/O) has 8 bits (GPIO~3 and GPO0~3). In default, all pins are pulled high with +3.3V level (according to main power). The BIOS default settings are 4 input pins set to high level and 4 output pins set to low level.

B.2 How to Use Digital I/O

Digital Input:

Start

↓

Clear SMBus status register:

-O E000 FE

↓

Set SMBus slave address register:

-O E004 41

↓

Set SMBus command register:

-O E003 00

↓

Execute SMBus control register:

-O E002 48

↓

Read GPI status

-I E005

Digital Output:

Start

↓

Clear SMBus status register:

-O E000 FE

↓

Set SMBus slave address register:

-O E004 40

↓

Set SMBus command register:

-O E003 01

↓

Set GPO status:

-O E005 F0

; Set GPO 4 bits status

; (F: All GPO 4 bits are set to high level)

↓

Set SMBus command register:

-O E003 01

↓

Execute SMBus:

-O E002 48

This page is intentionally left blank.

Appendix C

BIOS Flash Utility

The BIOS Flash utility is a new helpful function in BIOS setup program. With this function you can easily update system BIOS without having to enter operating system. In this appendix you may learn how to do it in just a few steps. Please read and follow the instructions below carefully.

1. In your USB flash drive, create a new folder and name it “Axiomtek”, see figure below.

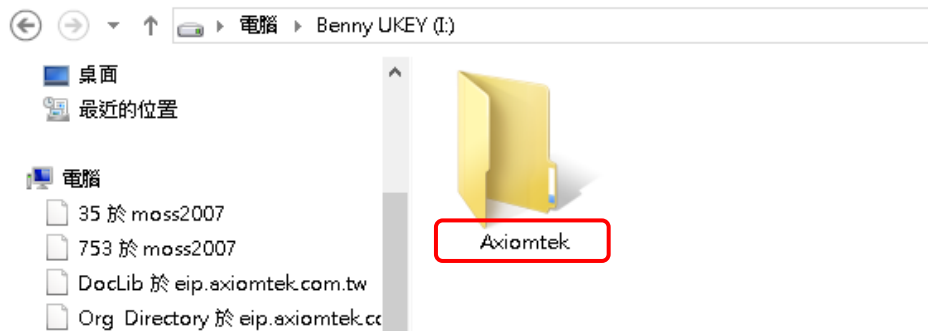

2. Copy BIOS ROM file (e.g. CEM846.005) to “Axiomtek” folder.

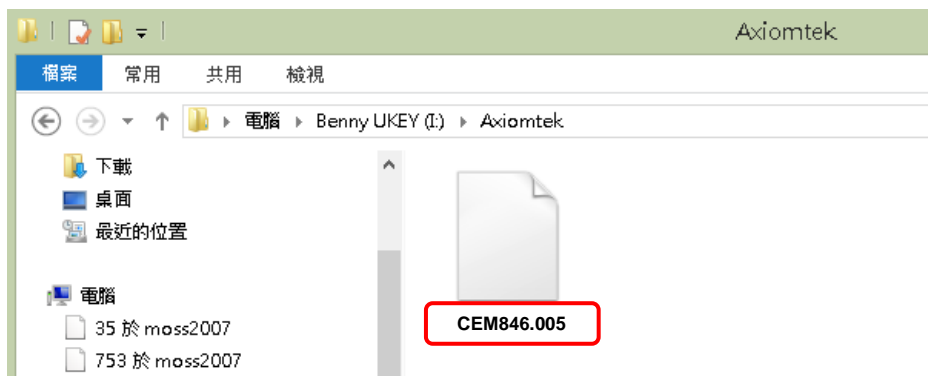

3. Insert the USB flash drive to your system.
4. Enter BIOS setup menu and go to Advanced\Utility Configuration. Select BIOS Flash Utility and press <Enter>.

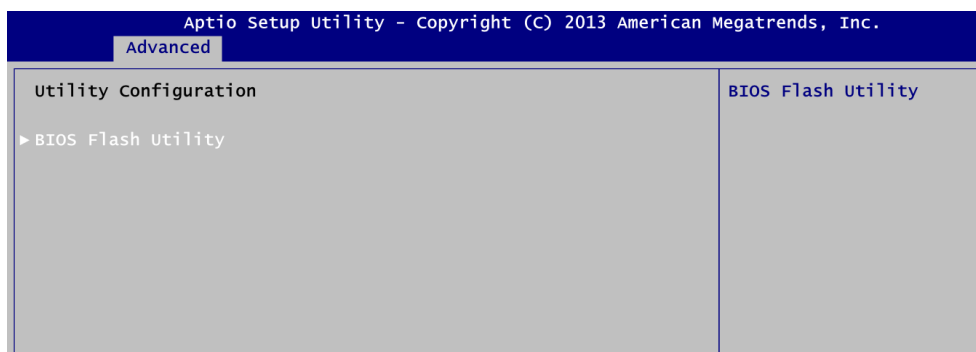

5. BIOS automatically detect all USB drive(s) attached to the system. In this example only one USB drive is attached to the system. That's why, you can see only one device is displayed in figure below.

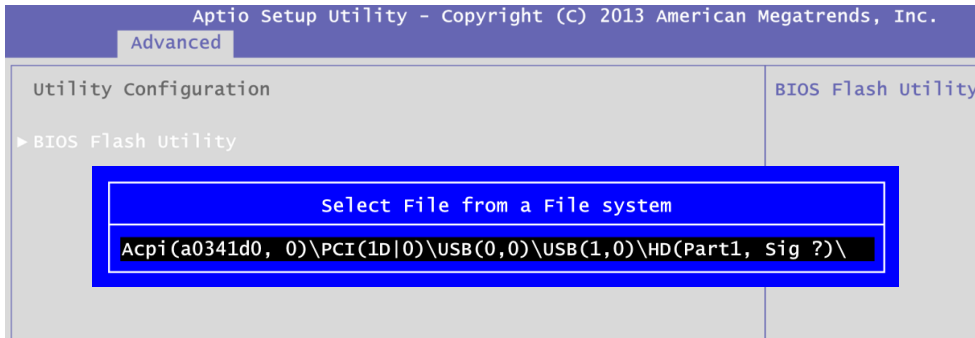

6. Select the USB drive containing BIOS ROM file you want to update using the <↑> or <↓> key. Then press <Enter> to get into "Axiomtek" folder.

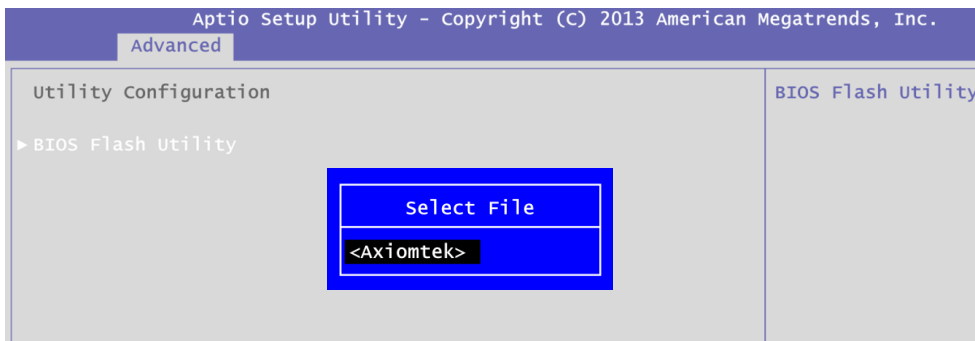

7. Now you can see the BIOS ROM file on the screen, press <Enter> to select.

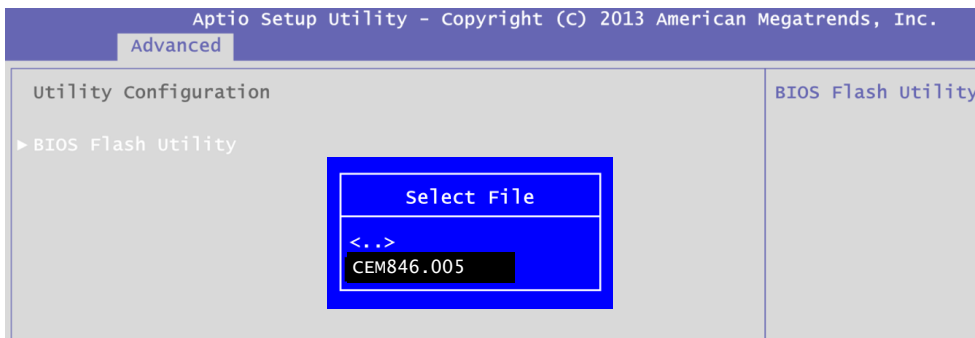

8. Select Start to flash system BIOS option to begin updating procedure.

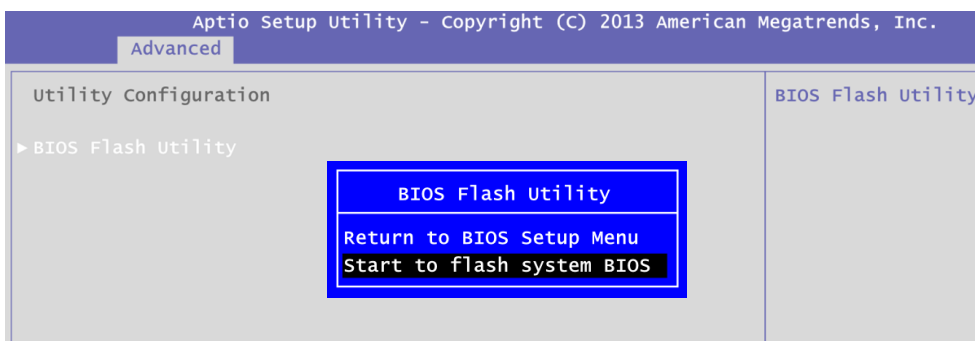

- Please wait while BIOS completes the entire flash update process: erase data, write new data and verify data.

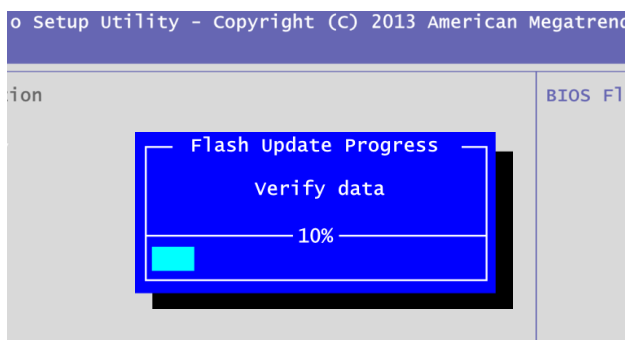
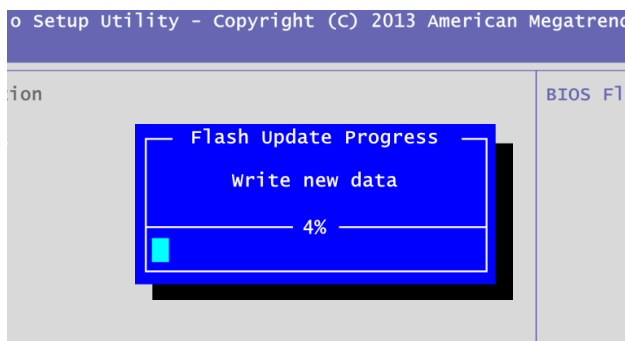
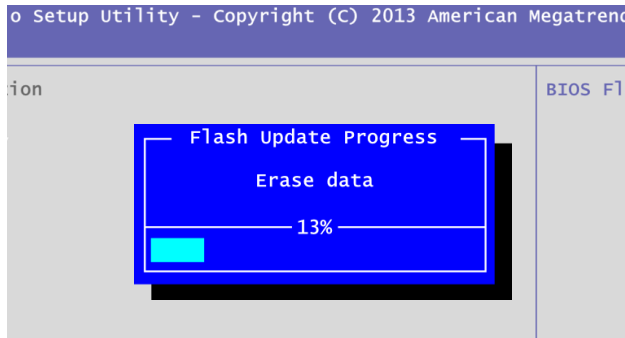

- When you see the following figure, press <Enter> to finish the update process. After that the system will shut down and restart immediately.

