

Lantech

I(P)WMR-3006

Industrial Multifunction VPN Router w/up to 2x WiFi 11ac + up to 2 LTE 4G + 2 serial ports + 6 Gigabit Ethernet Switch(incl. 4 PoE)

I(P)WMR-3004

Industrial Multifunction VPN Router w/up to 2x WiFi 11ac + up to 2 LTE 4G + 2 serial ports + 4 Gigabit Ethernet PoE Switch + 2 WAN ports

I(P)WMR-3204DF

Industrial Multifunction VPN Router Managed switch w/up to 2x WiFi 11ac + up to 2 LTE 4G + 2 serial ports + 4 GigaT (incl. 4 PoE) + 2 Dual Speed SFP

I(P)WMR-3004DF

Industrial Multifunction VPN Router Managed switch w/up to 2x WiFi 11ac + up to 2 LTE 4G + 2 serial ports + 4 GigaT (incl. 4 PoE) + 2 WAN Dual Speed SFP

I(P)MR-3006

Industrial Multifunction VPN Router w/up to 2 LTE 4G + 2 serial ports + 6 Gigabit Ethernet Switch(incl. 4 PoE)

I(P)MR-3004

Industrial Multifunction VPN Router w/up to 2 LTE 4G + 2 serial ports + 4 Gigabit Ethernet (PoE) Switch + 2 WAN ports

I(P)MR-3204DF

Industrial Multifunction VPN Router Managed Ethernet switch w/up to 2 LTE 4G + 2 serial ports + 4 Gigabit Ethernet (incl. 4 PoE) + 2 dual speed SFP

I(P)MR-3004DF

Industrial Multifunction VPN Router Managed Ethernet switch w/up to 2 LTE 4G + 2 serial ports + 4 Gigabit Ethernet (incl. 4 PoE) + 2 WAN Dual Speed SFP

User Manual (Hardware)

Recommendation for Shielded network cables

STP cables have additional shielding material that is used to reduce external interference. The shield also reduces the emission at any point in the path of the cable. Our recommendation is to deploy an STP network cable in demanding electrical environments. Examples of demanding indoor environments are where the network cable is located in parallel with electrical mains supply cables or where large inductive loads such as motors or contactors are in close vicinity to the camera or its cable. It is also mandatory to use an STP cable where the power device (like IP camera) is used outdoors or where the network cable is routed outdoors.

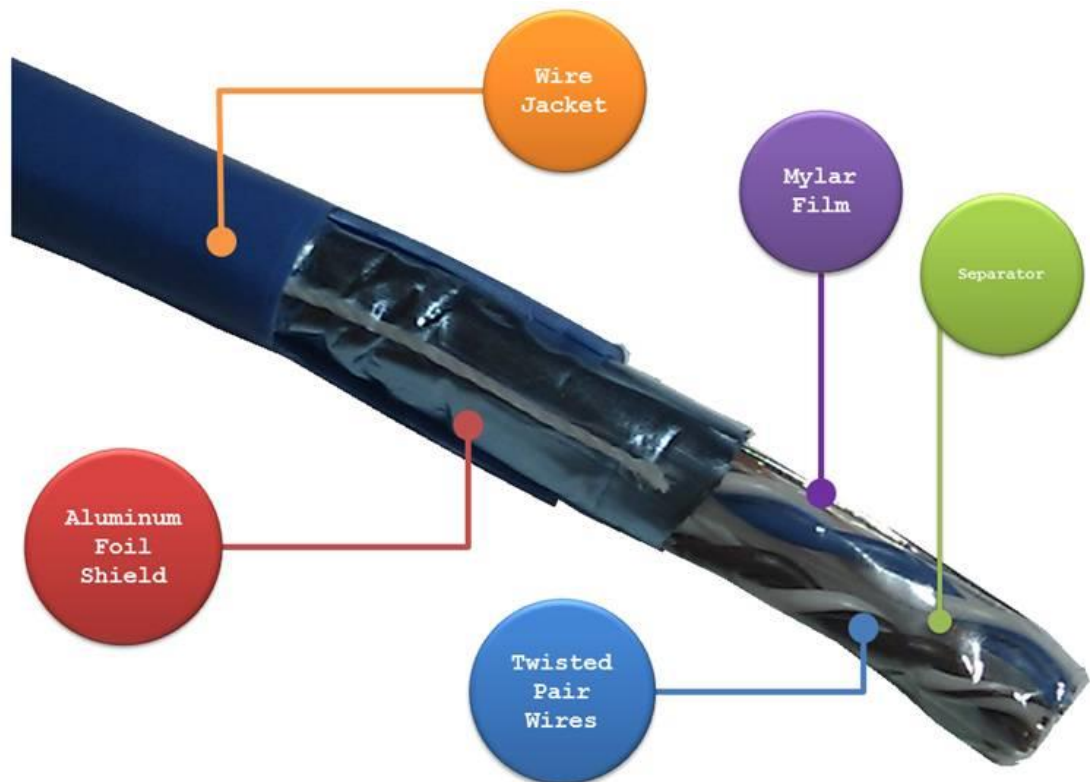

Important Notice

Lantech Communications Global, Inc. reserves the right to modify the equipment, its specification or this manual without prior notice, in the interest of improving performance, reliability, or servicing. At the time of publication all data is correct for the operation of the equipment at the voltage and/or temperature referred to. Performance data indicates typical values related to the particular product.

No part of this documentation or information supplied may be divulged to any third party without the express written consent of Lantech Communications Global Inc. Products offered may contain software which is proprietary to Lantech Communications Global Inc. The offer or supply of these products and services does not include or infer any transfer of ownership.

Interference Issues

This Equipment has been tested and found to comply with the limits for a Class A digital device, pursuant to Part 15 of the FCC rules. These limits are designed to provide reasonable protection against harmful interference in a commercial or industrial installation. This equipment generates, uses, and can radiate radio frequency energy. It may cause harmful interference to radio communications if the equipment is not installed and used in accordance with the instructions.

FCC Warning

This Equipment has been tested and found to comply with the limits for a Class-A digital device, pursuant to Part 15 of the FCC rules. These limits are designed to provide reasonable protection against harmful interference in a residential installation. This equipment generates, uses, and can radiate radio frequency energy. It may cause harmful interference to radio communications if the equipment is not installed and used in accordance with the instructions. However, there is no guarantee that interference will not occur in a particular installation. If this equipment does cause harmful interference to radio or television reception, which can be determined by turning the equipment off and on, the user is encouraged to try to correct the interference by one or more of the following measures:

- Reorient or relocate the receiving antenna.
- Increase the separation between the equipment and receiver.
- Connect the equipment into an outlet on a circuit different from that to which the receiver is connected.
- Consult the dealer or an experienced radio/TV technician for help.

CE Mark Warning

This is a Class-A product. In a domestic environment this product may cause radio interference in which case the user may be required to take adequate measures.

Content

1.	Hardware Description	2
1.1.	Physical Dimension.....	2
1.2.	IP Protection.....	3
1.3.	Front Panel.....	7
1.4.	LED Indicators.....	11
2.	Hardware Installation	13
2.1.	Hardware installation.....	13
2.2.	DIN-Rail Mounting	14
2.3.	Wall Mount Plate Mounting	15
2.4.	Wiring the Power Inputs	17
2.5.	Wiring the Fault Alarm Contact	18
2.6.	Wiring the DIDO.....	19
2.7.	Cabling	20
2.8.	SIM.....	23
2.9.	Serial Ports	25
3.	Console Management	26
3.1.	Connecting to the Console Port	26
3.2.	Login in the Console Interface	27

1. Hardware Description

Lantech I(P)WMR-3XXX & I(P)MR-3XXX series are next generation industrial multi-function VPN routers.

In this paragraph, it will describe the Industrial multi-function VPN router's hardware spec, port, cabling information, and wiring installation.

1.1. Physical Dimension

I(P)WMR-3006, I(P)WMR-3004, I(P)MR-3006, I(P)MR-3004: 74(W) x 142 (D) x 152 (H) mm, Metal case, IP-30

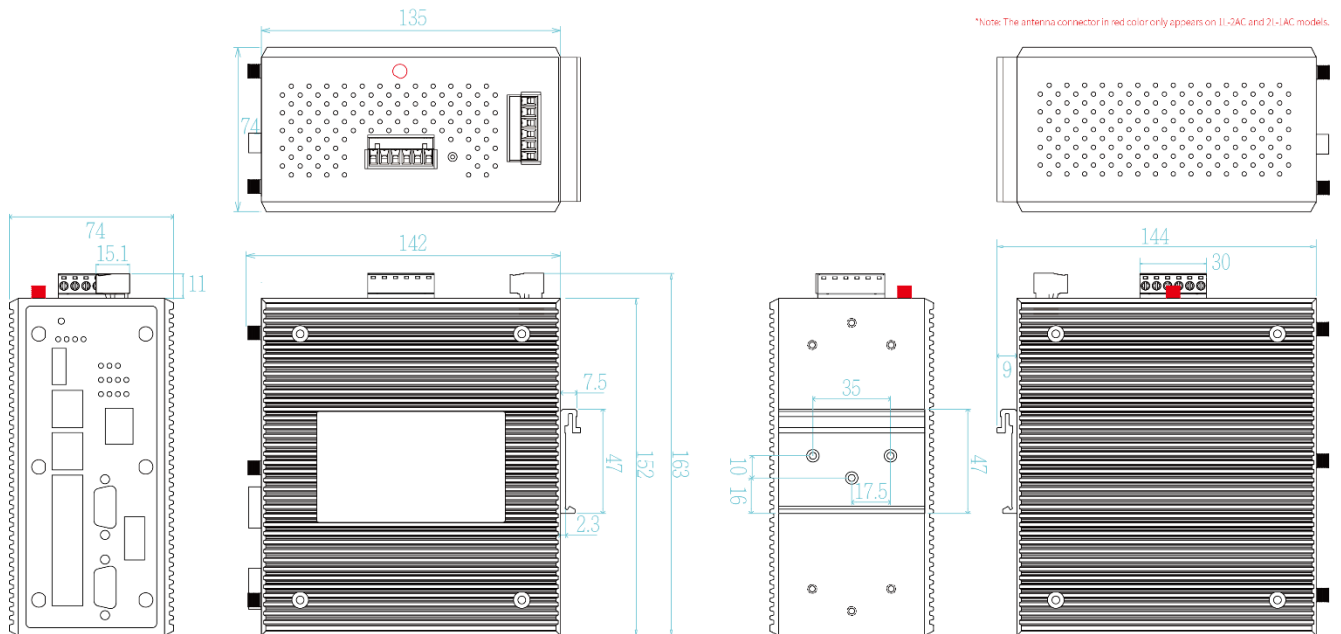

I(P)WMR-3204DF, I(P)WMR-3004DF, I(P)MR-3204DF, I(P)MR-3004DF: 74(W) x 142 (D) x 152 (H) mm, Metal case, IP-30

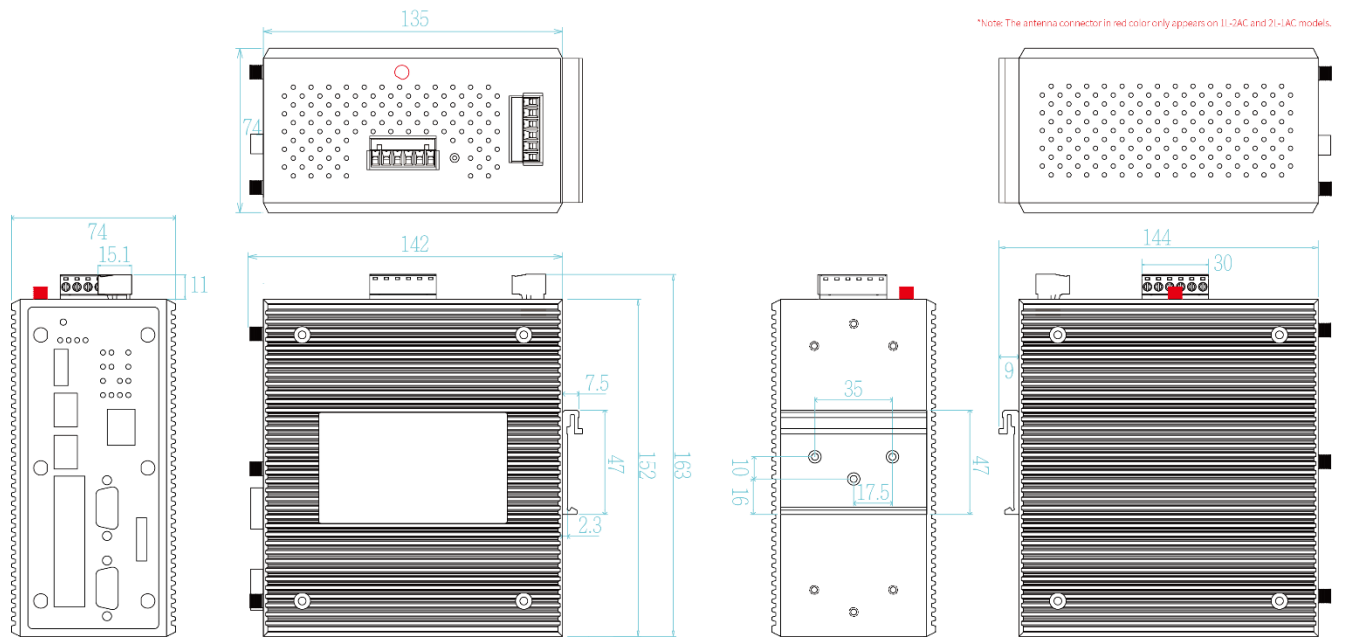

1.2. IP Protection

The **IP Code**, **Ingress Protection Rating**, sometimes also interpreted as **International Protection Rating**, classifies and rates the degree of protection provided against the intrusion (including body parts such as hands and fingers), dust, accidental contact, and water in *mechanical casings* and with electrical enclosures. It is published by the International Electrotechnical Commission (IEC)

Solid particle protection

The first digit indicates the level of protection that the enclosure provides against access to hazardous parts (e.g., electrical conductors, moving parts) and the ingress of solid foreign objects.

Level	Object size protected against	Effective against
0	—	No protection against contact and ingress of objects
1	>50 mm	Any large surface of the body, such as the back of a hand, but no protection against deliberate contact

		with a body part
2	>12.5 mm	Fingers or similar objects
3	>2.5 mm	Tools, thick wires, etc.
4	>1 mm	Most wires, screws, etc.
5	Dust protected	Ingress of dust is not entirely prevented, but it must not enter in sufficient quantity to interfere with the satisfactory operation of the equipment; complete protection against contact
6	Dust tight	No ingress of dust; complete protection against contact

Liquid ingress protection

The second digit indicates the level of protection that the enclosure provides against harmful ingress of water.

Level	Protected against	Testing for	Details
0	Not protected	—	—
1	Dripping water	Dripping water (vertically falling drops) shall have no harmful effect.	Test duration: 10 minutes Water equivalent to 1 mm rainfall per minute
2	Dripping water when tilted up to 15°	Vertically dripping water shall have no harmful effect when the enclosure is tilted at an angle up to 15° from its normal position.	Test duration: 10 minutes Water equivalent to 3 mm rainfall per minute
3	Spraying water	Water falling as a spray at any angle up to 60° from	Test duration: 5 minutes Water volume: 0.7 litres per

		the vertical shall have no harmful effect.	minute Pressure: 80–100 kPa
4	Splashing of water	Water splashing against the enclosure from any direction shall have no harmful effect.	Test duration: 5 minutes Water volume: 10 litres per minute Pressure: 80–100 kPa
5	Water jets	Water projected by a nozzle (6.3 mm) against enclosure from any direction shall have no harmful effects.	Test duration: at least 15 minutes Water volume: 12.5 litres per minute Pressure: 30 kPa at distance of 3 m
6	Powerful water jets	Water projected in powerful jets (12.5 mm nozzle) against the enclosure from any direction shall have no harmful effects.	Test duration: at least 3 minutes Water volume: 100 litres per minute Pressure: 100 kPa at distance of 3 m
7	Immersion up to 1 m	Ingress of water in harmful quantity shall not be possible when the enclosure is immersed in water under defined conditions of pressure and time (up to 1 m of submersion).	Test duration: 30 minutes Immersion at depth of at least 1 m measured at bottom of device, and at least 15 cm measured at top of device
8	Immersion beyond 1 m	The equipment is suitable for continuous immersion in water under conditions which shall be specified by the manufacturer. Normally, this will mean	Test duration: continuous immersion in water Depth specified by manufacturer

		<p>that the equipment is hermetically sealed.</p> <p>However, with certain types of equipment, it can mean that water can enter but only in such a manner that it produces no harmful effects.</p>	
9	<p>Powerful high temperature water jets</p>	<p>Protected against close-range high pressure, high temperature spray downs.</p>	—

1.3. Front Panel

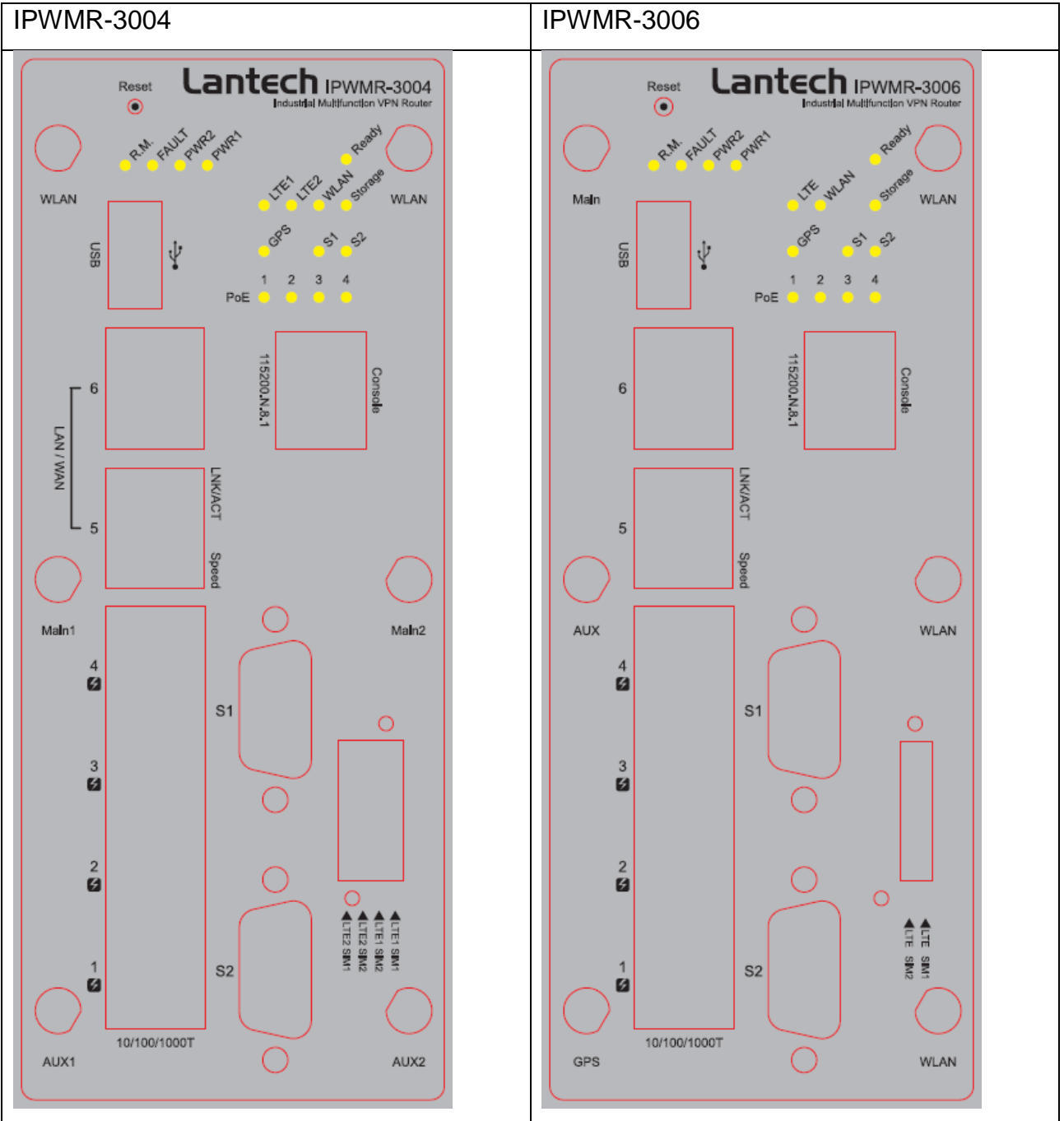

IPWMR-3204DF

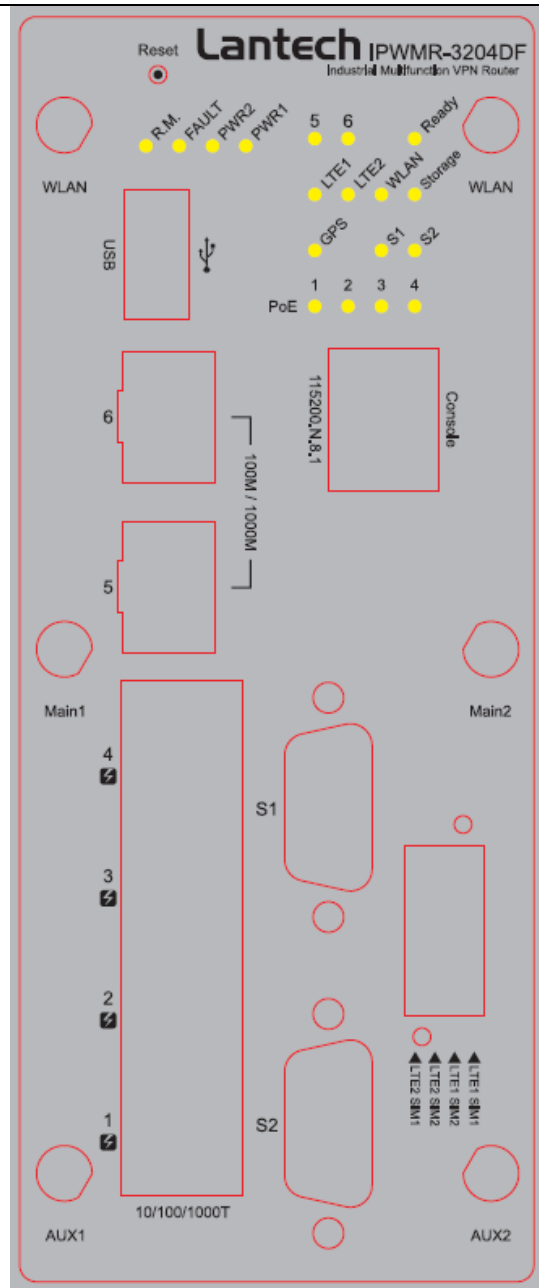

IPWMR-3004DF

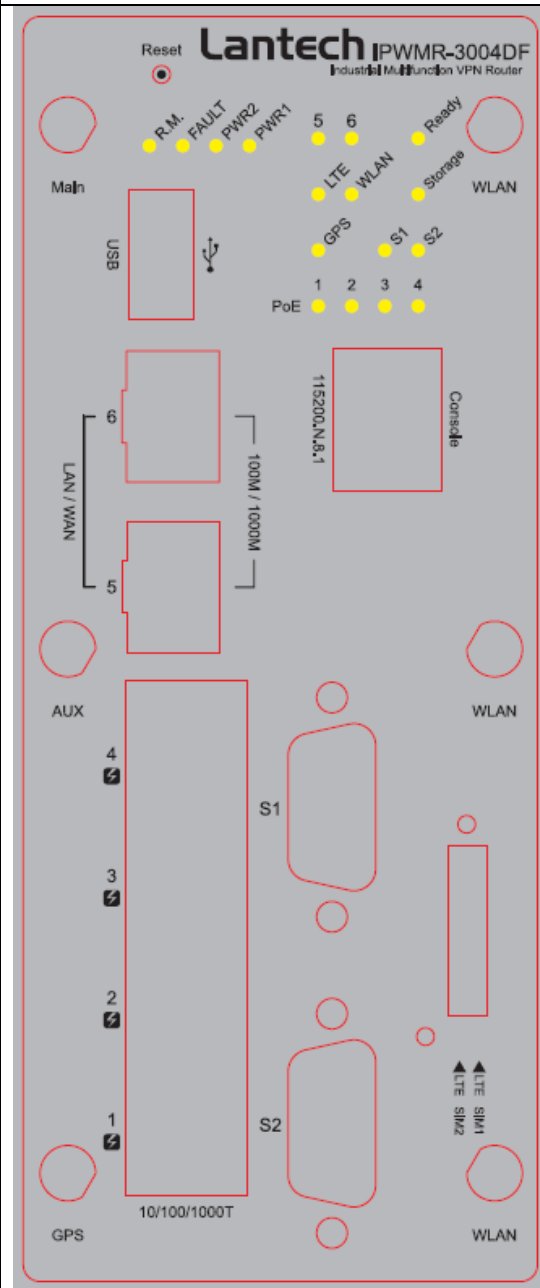

IPMR-3004

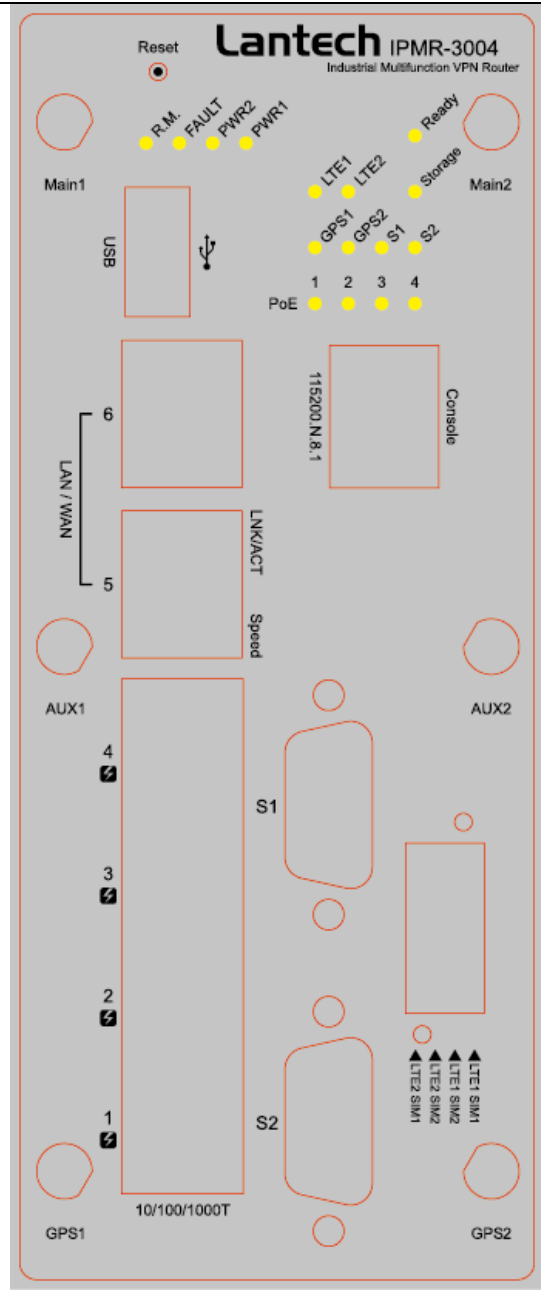

IPMR-3006

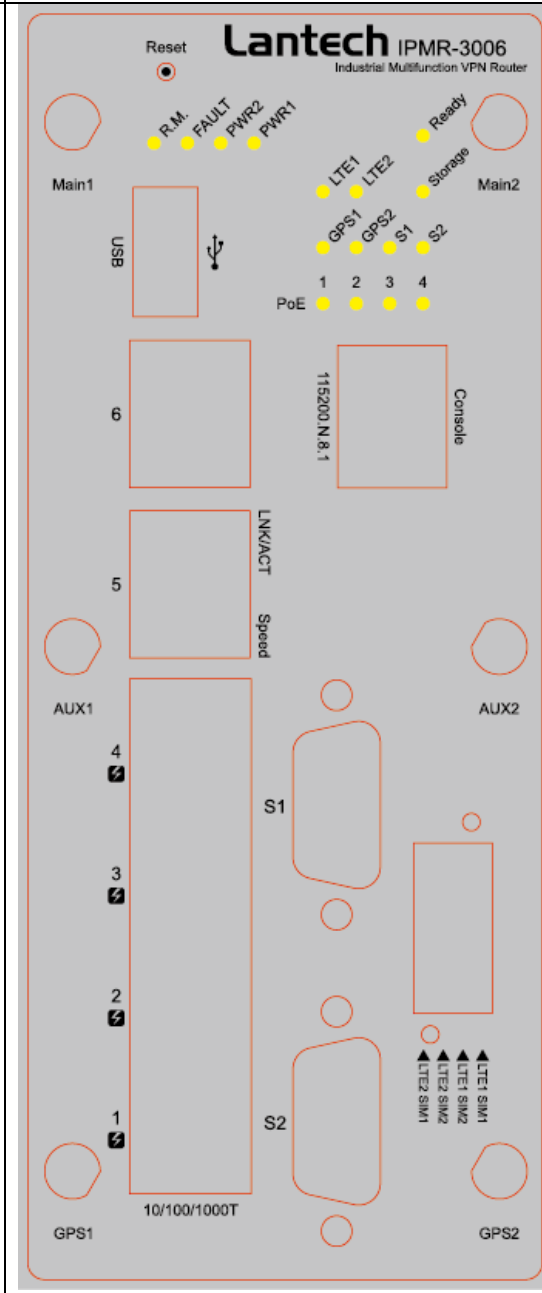

IPMR-3204DF

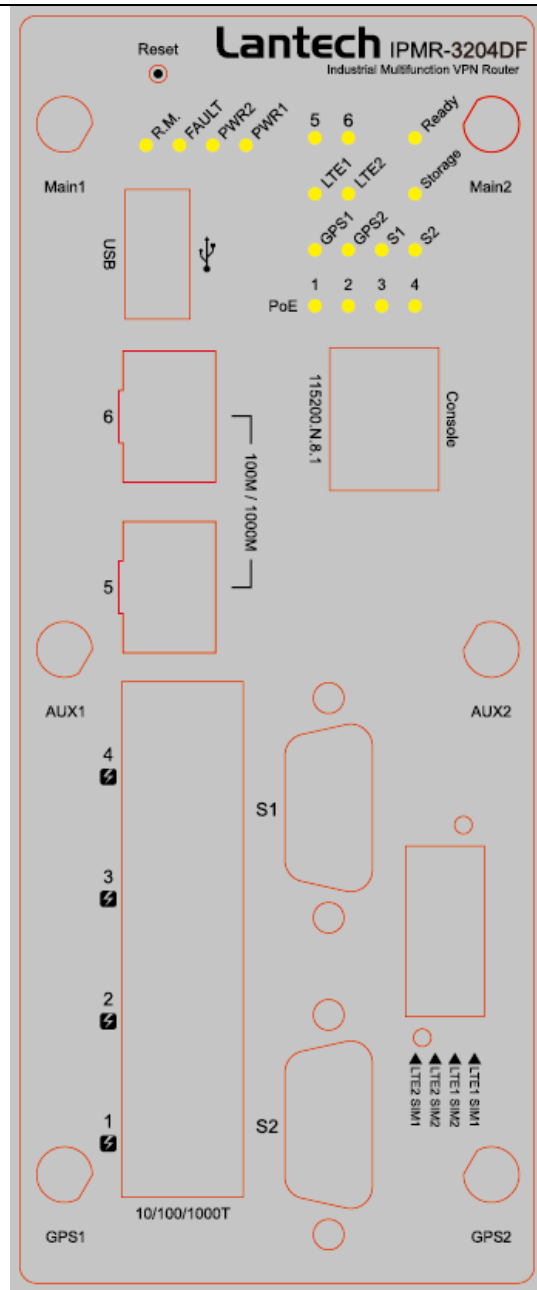

IPMR-3004DF

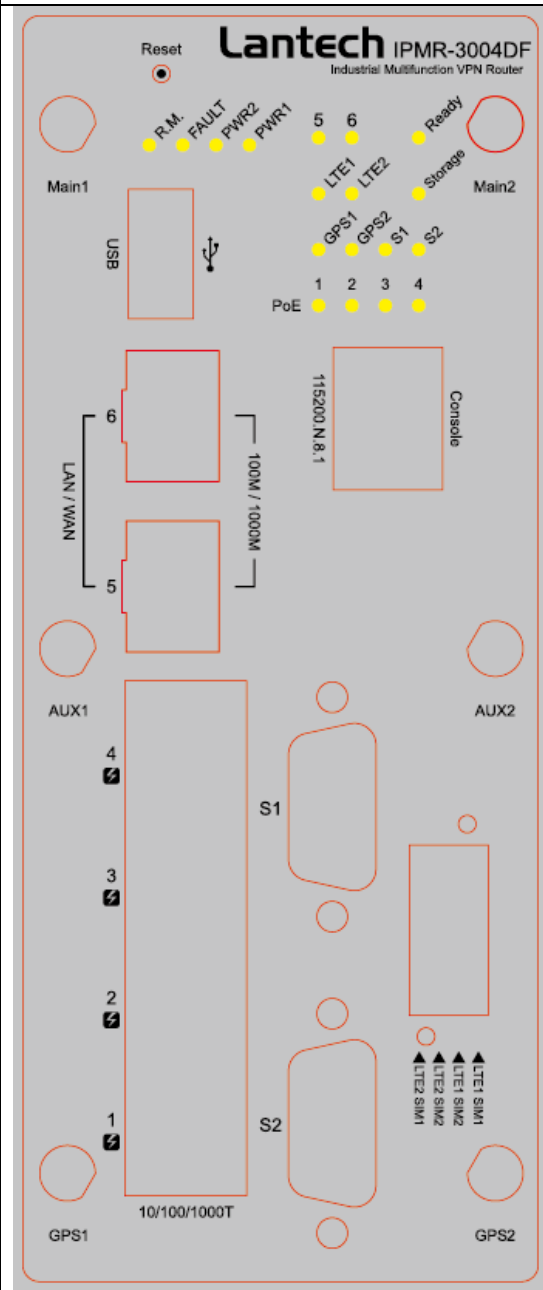

1.4.LED Indicators

The diagnostic LEDs that provide real-time information of system and optional status are located on the front panel of the industrial switch. The following table provides the description of the LED status and their meanings for the switch.

LED	Color	Status	Meaning
PWR1	Green	On	Power 1 is active
		Off	Power 1 is inactive
PWR2	Green	On	Power 2 is active
		Off	Power 2 is inactive
Fault	Red	On	Power or port failure
		Off	No failure
LTE	Green	On	LTE is active
		Off	LTE is inactive
WLAN	Green	On	WLAN is active
		Off	WLAN is inactive
GPS	Green	On	GPS OK
		Blinking	Searching GPS Signal
Ready	Green	On	Power is on and functioning normally.
RJ45 LNK/ACT	Green	On	A network device is detected.
		Blinking	The port is transmitting or receiving packets from the TX device.
		Off	No device attached
RJ45 Speed	Yellow	On	The port is operating in 1000T mode.
		Off	The port is operating in 10/100TX mode.
SFP (P5)	Green	On	The port is operating.

P6)		Off	The port is not operating.
-----	--	-----	----------------------------

2. Hardware Installation

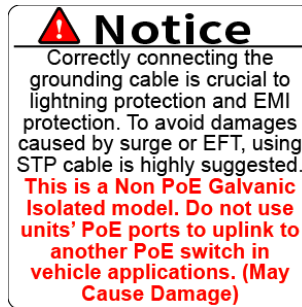

For POE models: Do not use units' POE ports to uplink to another POE switch in vehicle applications. (May Cause Damage) Lantech strongly advise the installation of a Galvanic isolated DC/DC converter between the power supply and the Ethernet switch on all Non-Isolated models. Please contact the sales team for advice on which models support isolated power design.

2.1. Hardware installation

1. Unpack the Industrial switch
2. Check if the DIN-Rail is screwed on the Industrial switch or not. If the DIN-Rail is not screwed on the Industrial switch, please refer to **DIN-Rail Mounting** section for DIN-Rail installation. If users want to wall mount the Industrial switch, please refer to **Wall Mount Plate Mounting** section for wall mount plate installation. **NOTE: Wall mount kits are optional accessories.**
3. To hang the Industrial switch on the DIN-Rail track or wall.
4. Power on the Industrial switch. Please refer to the **Wiring the Power Inputs** section for knowing the information about how to wire the power. The power LED on the Industrial switch will light up. Please refer to the **LED Indicators** section for indication of LED lights.
5. Prepare the twisted-pair, straight through Category 5 cable for Ethernet connection.
6. Insert one side of RJ-45 cable (category 5) into the Industrial switch Ethernet port (RJ-45 port) and another side of RJ-45 cable (category 5) to the network device's Ethernet port (RJ-45 port), ex: Switch PC or Server. The UTP port (RJ-45) LED on the Industrial switch will light up when the cable is connected with the network device. Please refer to the **LED Indicators** section for LED light indication.

[NOTE] Make sure that the connected network devices support MDI/MDI-X. If it does not

support, use the crossover category-5 cable.

When all connections are set and LED lights all show in normal, the installation is complete.

2.2.DIN-Rail Mounting

The DIN-Rail is screwed on the industrial switch when out of factory. If the DIN-Rail is not screwed on the industrial switch, please see the following pictures to screw the DIN-Rail on the switch. Follow the steps below to hang the industrial switch.

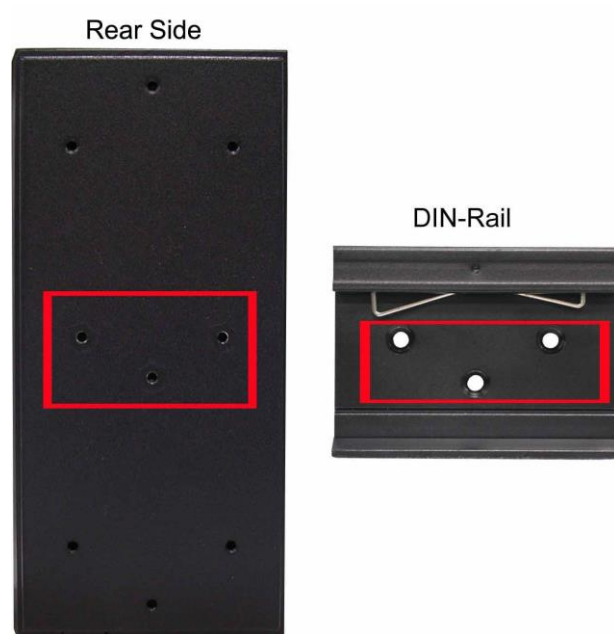

First, insert the top of DIN-Rail into the track.

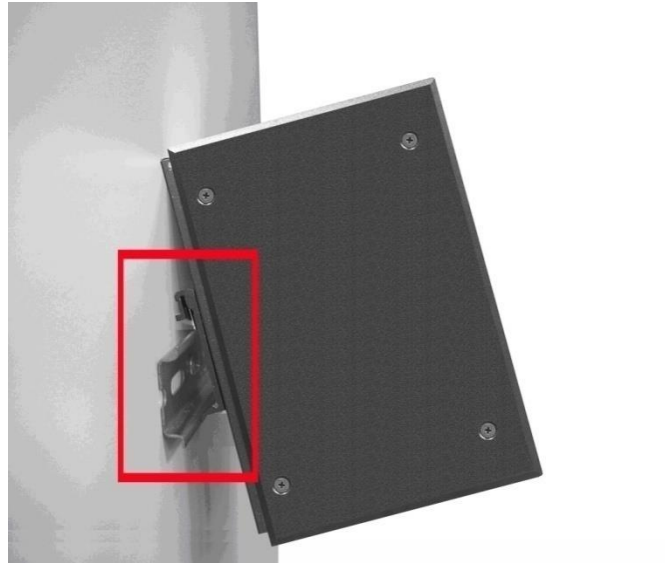

Then, lightly push the DIN-Rail into the track.

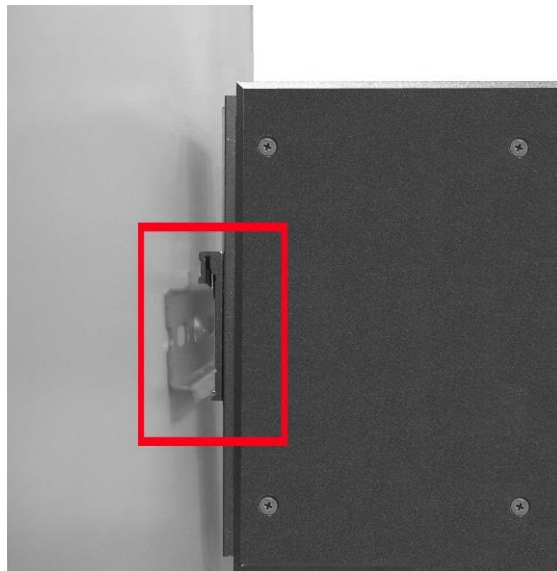

Check if the DIN-Rail is tightened on the track or not.

To remove the industrial switch from the track, reverse above steps.

2.3.Wall Mount Plate Mounting

Follow the steps below to mount the industrial switch with wall mount plate.

1. Remove the DIN-Rail from the industrial switch; loose the screws to remove the DIN-Rail.

2. Place the wall mount plate on the rear panel of the industrial switch.
3. Use the screws to screw the wall mount plate on the industrial switch.
4. Use the hook holes at the corners of the wall mount plate to hang the industrial switch on the wall.
5. To remove the wall mount plate, reverse the above steps.

NOTE : Wall mount kits are optional accessories

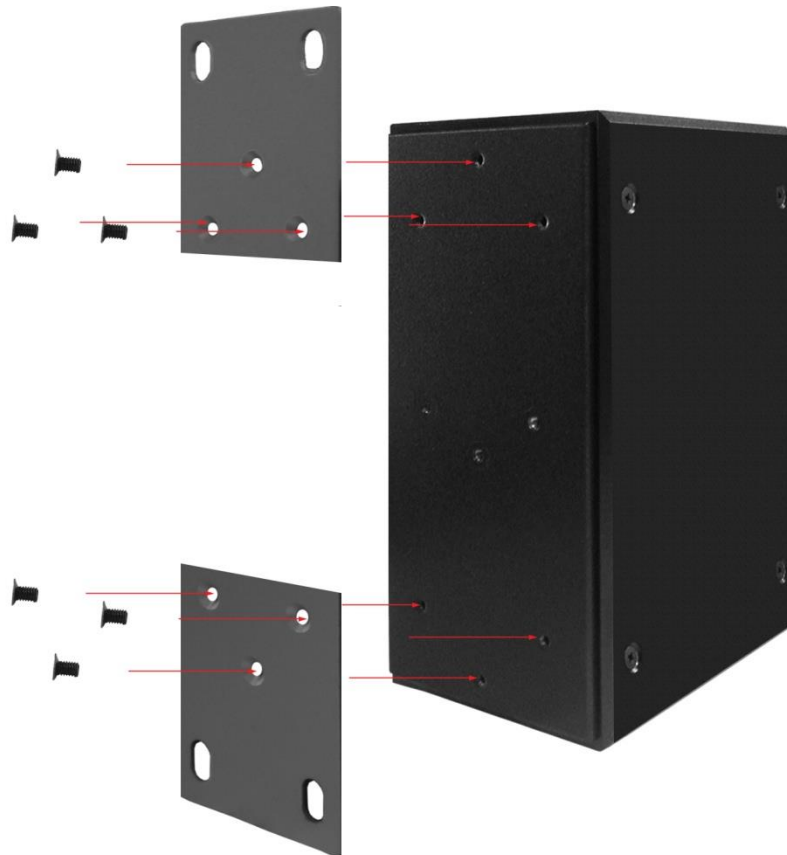

2.4. Wiring the Power Inputs

Please follow the steps below to insert the power wire.

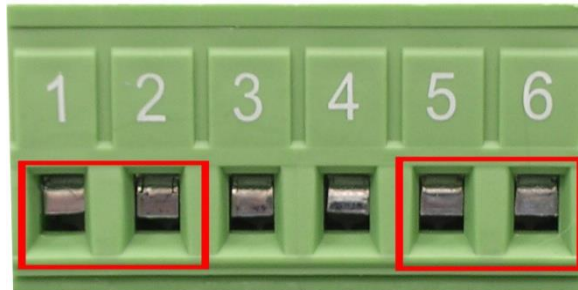

1. Insert AC or DC power wires into the contacts 1 and 2 for power 1, or 5 and 6 for power.



2. Tighten the wire-clamp screws for preventing the wires from losing.

[NOTE] The wire gauge for the terminal block should be in the range between 12 ~ 24 AWG.

2.5. Wiring the Fault Alarm Contact

The fault alarm contacts are in the middle of the terminal block connector as the picture shows below. Inserting the wires, the switch will detect the fault status of the power failure, or port link failure (available for managed model) and then forms an open circuit. The following illustration shows an application example for wiring the fault alarm contacts.



Insert the wires into the fault alarm contacts

[NOTE] The wire gauge for the terminal block should be in the range between 12 ~ 24 AWG.

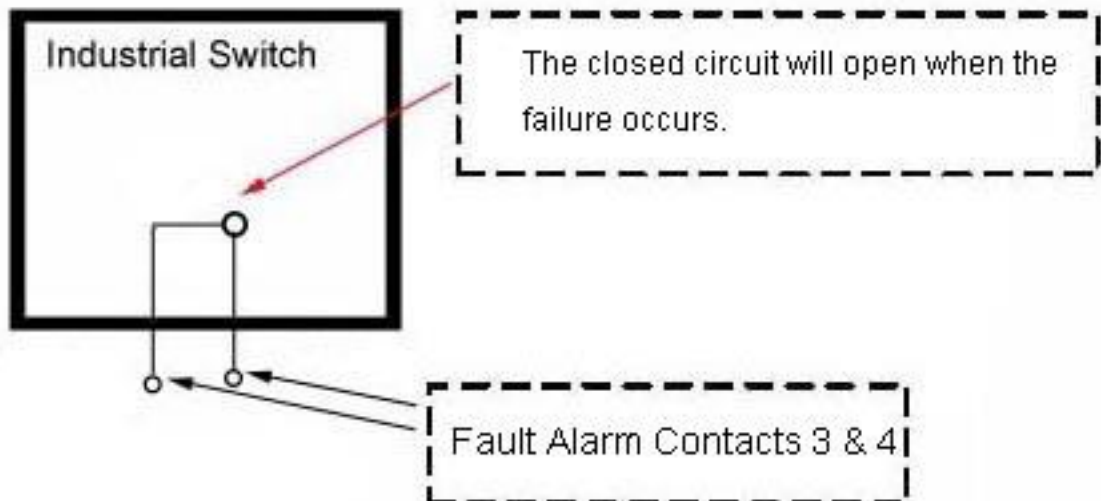

2.6. Wiring the DIDO

In case of event, the router being able to send an email to pre-defined addresses as well as SNMP Traps out immediately. It provides 2DI and 2DO (DI=Digital input / DO=Digital output). When disconnection of the specific port was detected; DO will activate the signal LED to alarm. DI can integrate the sensors for events and DO will trigger the alarm while sending alert information to IP network with email and traps.

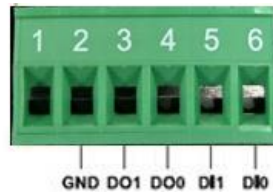

To connect with device in field, please check below diagram:

Digital Input

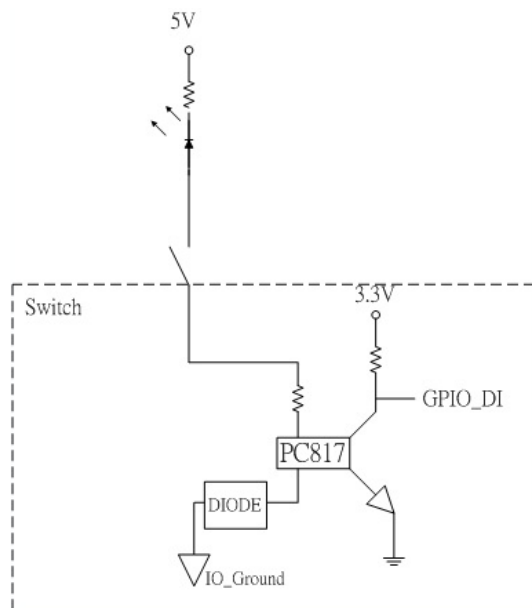

Digital Output

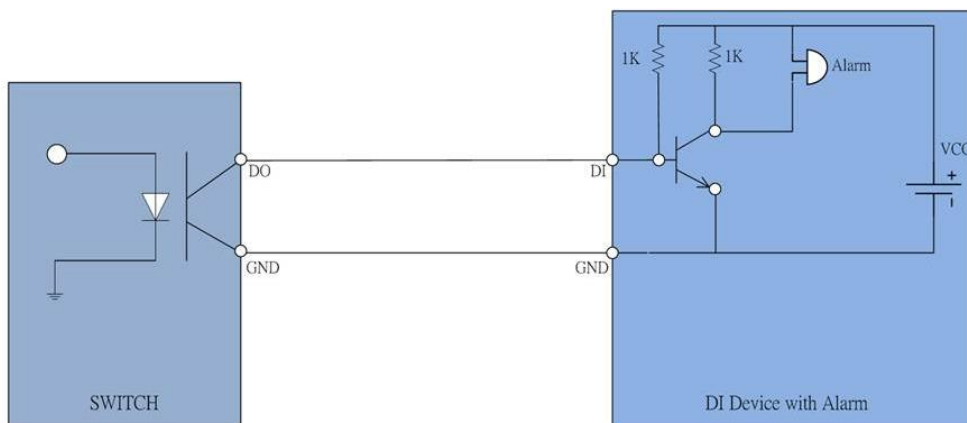

2.7.Cabling

- Use four twisted-pair, Category 5e or above cabling for RJ-45 port connection. The cable between the switch and the link partner (switch, hub, workstation, etc.) must be less than 100 meters (328 ft.) long.
- Fiber segment using **single-mode** connector type must use 9/125 μm single-mode fiber cable. User can connect two devices in the distance up to **30km**.
- Fiber segment using **multi-mode** connector type must use 50 or 62.5/125 μm multi-mode fiber cable. User can connect two devices up to **2km** distances.
- **Gigabit / 100M SFP port:**

The small form-factor pluggable (SFP) is a compact optical transceiver used in optical communications for both telecommunication and data communications. The SFP slots supporting Gigabit speed up to 1000Mbps. –DSFP/-DFT models support dual speed 100M or 1000Mbps. They are used for connecting to the network segment with single or multi-mode fiber. You can choose the appropriate SFP transceiver to plug into the slots. Then use proper multi-mode or single-mode fiber according to the transceiver. With fiber optic, it transmits at speed up to 1000 Mbps or dual speed (-DSFP/-DFT models) and you can prevent noise interference from the system.

To connect the transceiver and LC cable, please follow the steps shown below:

First, insert the transceiver into the SFP module. Notice that the triangle mark is the bottom of the module.



Transceiver to the SFP module

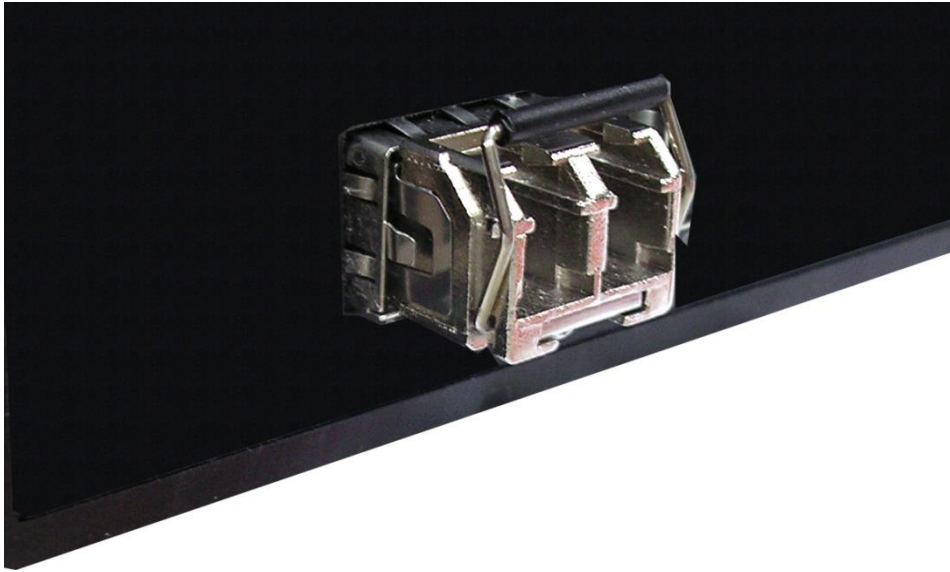

Transceiver Inserted

Second, insert the fiber cable of LC connector into the transceiver.

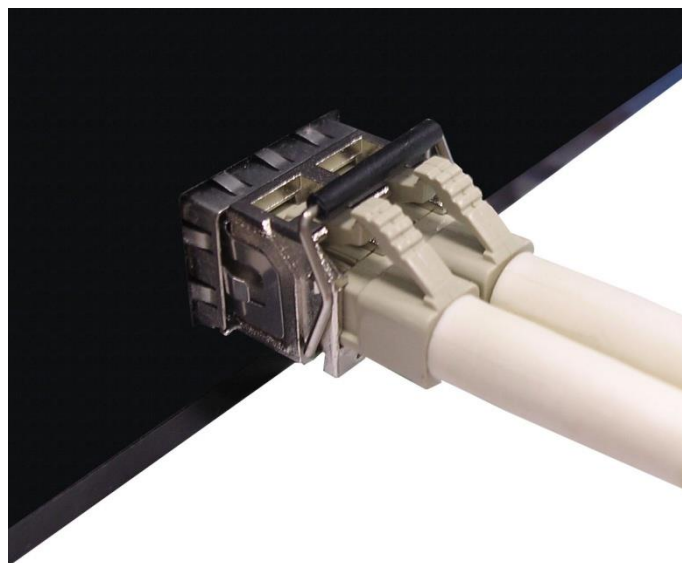

LC connector to the transceiver

To remove the LC connector from the transceiver, please follow the steps shown below:

First, press the upper side of the LC connector to release from the transceiver and pull it out.

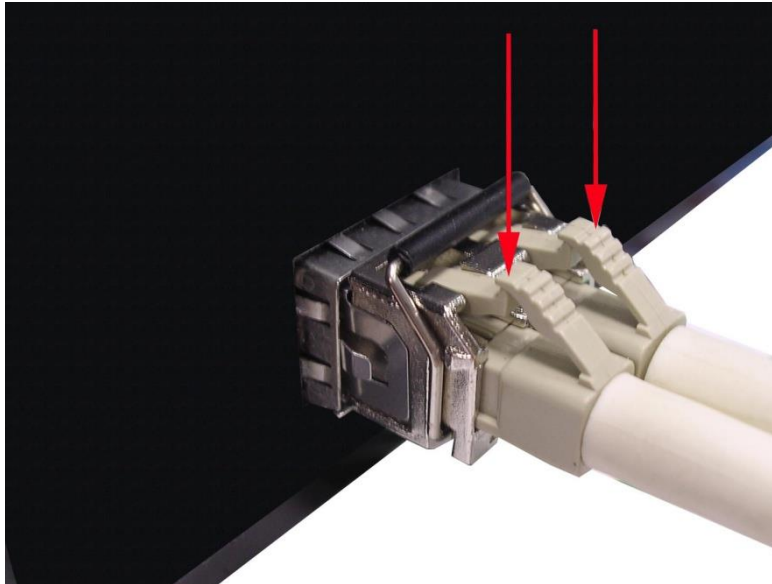

Remove LC connector

Second, push down the metal loop and pull the transceiver out by the plastic handle.

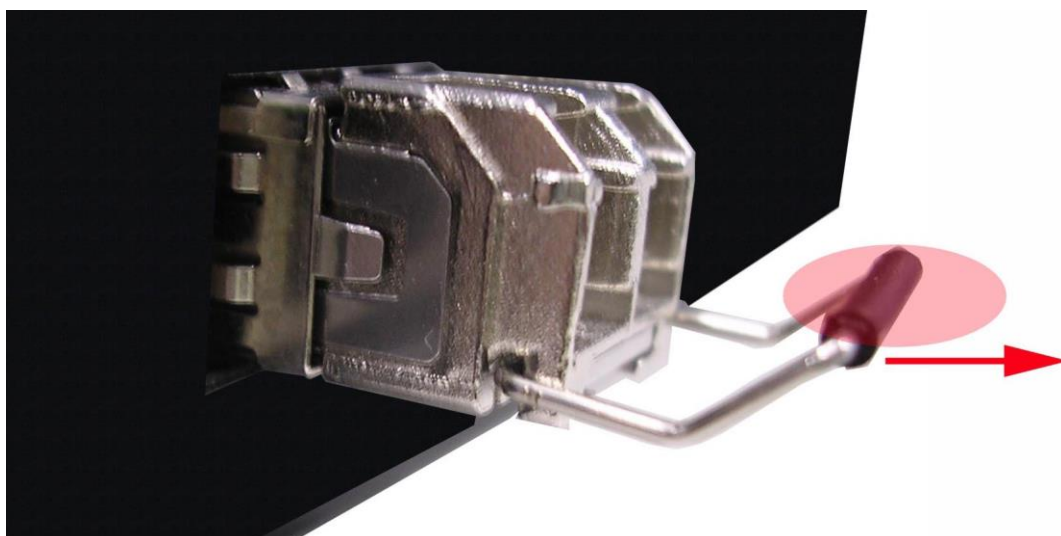

Pull out from the transceiver

2.8.SIM

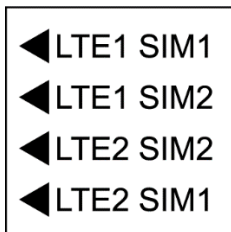

1. Turn off power of the device.
2. Use a screwdriver to loosen the screws and remove the SIM card cover..
3. Insert one or two 3G/4G SIM cards into the SIM card slots in the correct orientation and located on the bottom of the SIM card slot.
4. Turn on power of the device.
5. Reattach the cover

For LTE / LTE1 slot



Insert the SIM card into the SIM card slot with the gold contacts facing down.



Located on the bottom of the SIM card slot.

For LTE2 slot



Insert the SIM card into the SIM card slot with the gold contacts facing up.



Located on the bottom of the SIM card slot.

2.9. Serial Ports

Connect the DB9 connector with RS232/RS422/RS485 cable with the following PIN assignment.

PIN Assignment of RS232

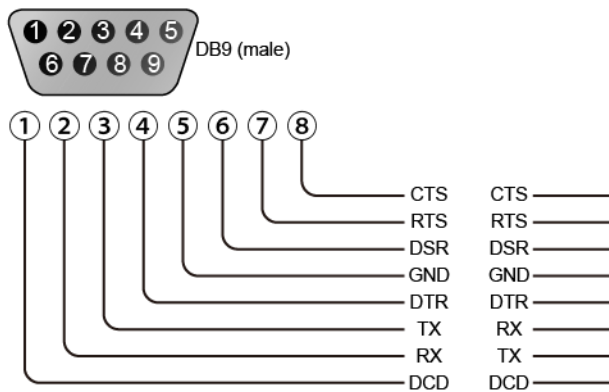

PIN Assignment of RS-422

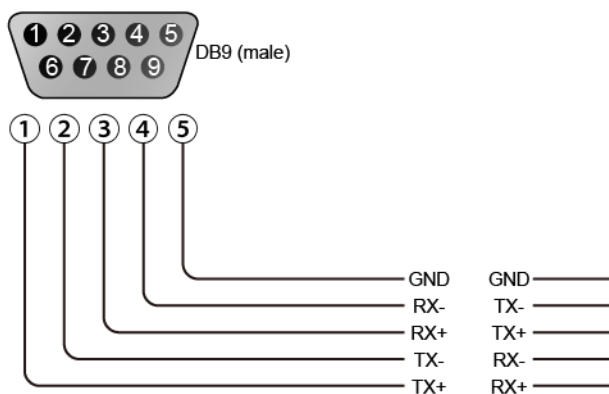

PIN Assignment of RS-485

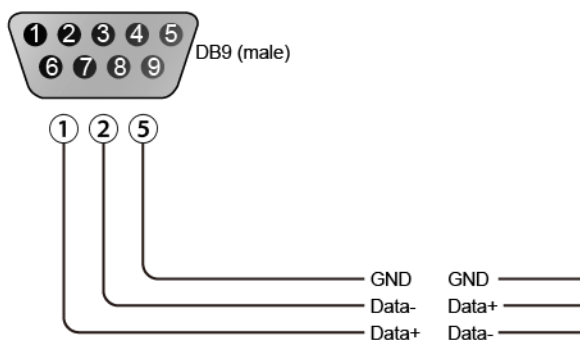

3. Console Management

3.1. Connecting to the Console Port

The supplied cable which one end is RS-232 connector and the other end is RJ-45 connector. Attach the end of RS-232 connector to PC or terminal and the other end of RJ-45 connector to the console port of the switch. The connected terminal or PC must support the terminal emulation program.

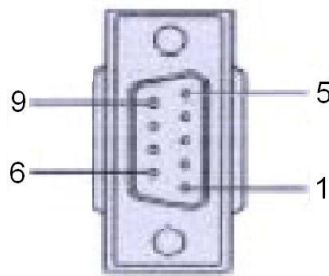
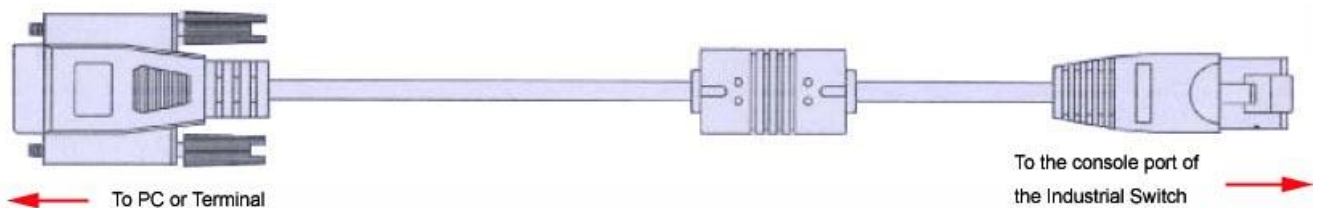

DB 9-pin Female

DB9 Connector	RJ-45 Connector
NC	1 Orange/White
2	2 Orange
3	3 Green/White
NC	4 Blue
5	5 Blue/White
NC	6 Green
NC	7 Brown/White
NC	8 Brown

Pin assignment

3.2. Login in the Console Interface

When the connection between Switch and PC is ready, turn on the PC and run a terminal emulation program or **Hyper Terminal** and configure its **communication parameters** to match the following default characteristics of the console port:

Baud Rate: 115200 bps

Data Bits: 8

Parity: none

Stop Bit: 1

Flow control: None

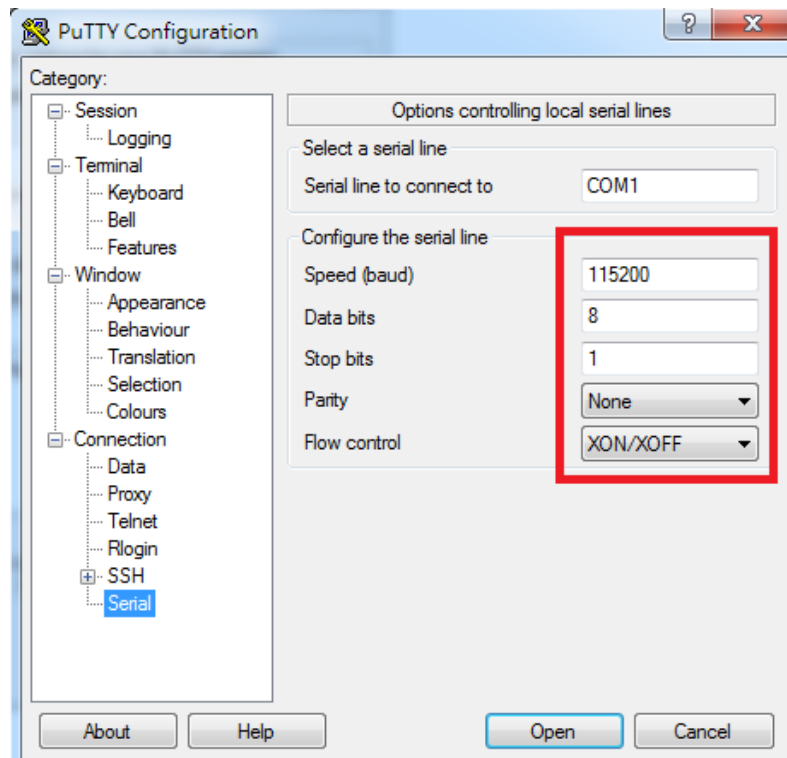

The settings of communication parameters

Having finished the parameter settings, click '**OK**'. When the blank screen shows up, press Enter key to have the login prompt appears. Key in '**admin**' (default value) for both User name and Password (use **Enter** key to switch), then press Enter and the Main Menu of console management appears. Please see below figure for login screen.

```
User Name : admin
Password  : ****
```

Console login interface

=====Notice=====

For web-based management, please refer to our “Software Management Manual”.
Please contact support@lantechcom.tw for more information.