

EPC-EHL

Intel® Elkhart Lake Fanless Compact System

Quick Reference Guide

2nd Ed – 17 November 2022

Copyright Notice

Copyright © 2022 Avalue Technology Inc., ALL RIGHTS RESERVED.

FCC Statement



THIS DEVICE COMPLIES WITH PART 15 FCC RULES. OPERATION IS SUBJECT TO THE FOLLOWING TWO CONDITIONS:

(1) THIS DEVICE MAY NOT CAUSE HARMFUL INTERFERENCE.

(2) THIS DEVICE MUST ACCEPT ANY INTERFERENCE RECEIVED INCLUDING INTERFERENCE THAT MAY CAUSE UNDESIRE OPERATION.

THIS EQUIPMENT HAS BEEN TESTED AND FOUND TO COMPLY WITH THE LIMITS FOR A CLASS "A" DIGITAL DEVICE, PURSUANT TO PART 15 OF THE FCC RULES.

THESE LIMITS ARE DESIGNED TO PROVIDE REASONABLE PROTECTION AGAINST HARMFUL INTERFERENCE WHEN THE EQUIPMENT IS OPERATED IN A COMMERCIAL ENVIRONMENT. THIS EQUIPMENT GENERATES, USES, AND CAN RADIATE RADIO FREQUENCY ENERGY AND, IF NOT INSTALLED AND USED IN ACCORDANCE WITH THE INSTRUCTION MANUAL, MAY CAUSE HARMFUL INTERFERENCE TO RADIO COMMUNICATIONS.

OPERATION OF THIS EQUIPMENT IN A RESIDENTIAL AREA IS LIKELY TO CAUSE HARMFUL INTERFERENCE IN WHICH CASE THE USER WILL BE REQUIRED TO CORRECT THE INTERFERENCE AT HIS OWN EXPENSE.

A Message to the Customer

Avalue Customer Services

Each and every Avalue's product is built to the most exacting specifications to ensure reliable performance in the harsh and demanding conditions typical of industrial environments. Whether your new Avalue device is destined for the laboratory or the factory floor, you can be assured that your product will provide the reliability and ease of operation for which the name Avalue has come to be known.

Your satisfaction is our primary concern. Here is a guide to Avalue's customer services. To ensure you get the full benefit of our services, please follow the instructions below carefully.

Technical Support

We want you to get the maximum performance from your products. So if you run into technical difficulties, we are here to help. For the most frequently asked questions, you can easily find answers in your product documentation. These answers are normally a lot more detailed than the ones we can give over the phone. So please consult the user's manual first.

To receive the latest version of the user's manual; please visit our Web site at:

<http://www.avalue.com.tw/>

Content

1. Getting Started	6
1.1 Safety Precautions	6
1.2 Packing List	6
1.3 System Specifications	7
1.4 System Overview.....	12
1.4.1 Front View/Side View	12
1.4.2 Rear View	13
1.5 System Dimensions.....	18
1.5.1 EPC-EHL Front & Top View	18
1.5.2 EPC-EHL-DIN Front & Top View.....	19
1.5.3 EPC-EHL-8USB Front & Top View.....	20
1.5.4 EPC-EHL-8COM Front & Top View.....	21
1.5.5 EPC-EHL-4LAN Front & Top View	22
2. Hardware Configuration	23
2.1 EPC-EHL connector mapping.....	24
2.1.1 Serial Port connector (COM)	24
2.2 ECM-EHL Product Overview	25
2.3 ECM-EHL Jumper and Connector List	26
2.4 ECM-EHL Setting Jumpers & Connectors	28
2.4.1 Serial port 1 pin9 signal select (JRI1).....	28
2.4.2 Clear CMOS (JBAT1)	28
2.4.3 AT/ATX Input power select (JAT1).....	29
2.4.4 LCD inverter connector (JBKL1).....	29
2.4.5 CPU fan connector (CPU_FAN1)	30
2.4.6 Serial port 1 in RS-422/485 mode (J422_485).....	30
2.4.7 Serial port 2 connector (JCOM2).....	31
2.4.8 Serial port 3 connector (JCOM3).....	31
2.4.9 Serial port 4 connector (JCOM4).....	32
2.4.10 General purpose I/O connector (JDIO1)	32
2.4.11 SATA Power connector (SATA_PWR1).....	33
2.4.12 Power connector (PWR1).....	33
2.4.13 USB2.0 connector (JUSB1).....	34
2.4.14 BIOS SPI connector (BIOS_SPI1).....	34
2.4.15 EC Debug connector (JEC_ROM1).....	35
2.4.16 Battery connector (BT1)	35

EPC-EHL

2.4.17	Front Panel connector (JFP1)	36
2.4.18	PC Buzzer connector (JBZ1).....	36
2.4.19	Cortex Debug + ETM connector (JPSE1)	37
2.4.20	Port80 connector (JESPI1).....	37
2.4.21	eDP connector (JEDP1)	38
2.4.22	Audio connector (JAUDIO1).....	38
2.4.22.1	Signal Description – Audio connector (JAUDIO1)	38
2.5	Installing Hard Disk & Memory (EPC-EHL)	39
2.6	Installing M.2 B-Key/M.2 E-Key card (EPC-EHL)	41
2.7	Installing Mounting Brackets (EPC-EHL).....	42
3	BIOS Setup	43
3.1	Introduction.....	44
3.2	Starting Setup.....	44
3.3	Using Setup	45
3.4	Getting Help.....	46
3.5	In Case of Problems	46
3.6	BIOS setup	47
3.6.1	Main Menu	47
3.6.1.1	System Language	48
3.6.1.2	System Date	48
3.6.1.3	System Time	48
3.6.2	Advanced Menu.....	48
3.6.2.1	CPU Configuration	49
3.6.2.2	Power & Performance	50
3.6.2.2.1	CPU – Power Management Control.....	50
3.6.2.2.1.1	View/Configure Turbo Options	51
3.6.2.2.2	GT – Power Management Control	52
3.6.2.3	PCH-FW Configuration.....	53
3.6.2.3.1	Firmware Update Configuration	53
3.6.2.3.2	PTT Configuration	54
3.6.2.4	Trusted Computing.....	54
3.6.2.5	APCI Settings	55
3.6.2.6	HW Monitor	55
3.6.2.7	NCT5124DSEC Super IO Configuration	56
3.6.2.7.1	Serial Port 1 Configuration	57
3.6.2.7.2	Serial Port 2 Configuration	57
3.6.2.7.3	Serial Port 3 Configuration	58
3.6.2.7.4	Serial Port 4 Configuration	58
3.6.2.8	S5 RTC Wake Settings	59
3.6.2.9	Serial Port Console Redirection	59

3.6.2.10	USB Configuration.....	60
3.6.2.11	Network Stack Configuration.....	61
3.6.2.12	NVMe Configuration	62
3.6.3	Chipset.....	62
3.6.3.1	System Agent (SA) Configuration	63
3.6.3.1.1	Memory Configuration	63
3.6.3.1.2	Graphics Configuration.....	64
3.6.3.2	PCH-IO Configuration	65
3.6.3.2.1	PCI Express Configuration.....	65
3.6.3.2.1.1	PCI Express Root Port 1(M.2 KeyB).....	66
3.6.3.2.1.2	PCI Express Root Port 3(M.2 KeyE).....	67
3.6.3.2.1.3	PCI Express Root Port 4(i225-LM)	68
3.6.3.2.1.4	PCI Express Root Port 7(i210)	69
3.6.3.2.1.5	PCIE clocks.....	70
3.6.3.2.2	SATA Configuration.....	71
3.6.3.2.3	USB Configuration.....	72
3.6.3.2.4	HD Audio Configuration	73
3.6.3.3	Board & Panel Configuration.....	73
3.6.4	Security.....	75
3.6.4.1	Secure Boot.....	75
3.6.4.1.1	Key Management	76
3.6.5	Boot.....	77
3.6.6	Save and exit	78
3.6.6.1	Save Changes and Exit.....	78
3.6.6.2	Discard Changes and Exit.....	78
3.6.6.3	Save Changes and Reset	79
3.6.6.4	Discard Changes and Reset	79
3.6.6.5	Save Changes.....	79
3.6.6.6	Discard Changes.....	79
3.6.6.7	Restore Defaults.....	79
3.6.6.8	Save as User Defaults.....	79
3.6.6.9	Restore User Defaults	79

1. Getting Started

1.1 Safety Precautions

Warning!



Always completely disconnect the power cord from your chassis whenever you work with the hardware. Do not make connections while the power is on. Sensitive electronic components can be damaged by sudden power surges. Only experienced electronics personnel should open the PC chassis.

Caution!



Always ground yourself to remove any static charge before touching the CPU card. Modern electronic devices are very sensitive to static electric charges. As a safety precaution, use a grounding wrist strap at all times. Place all electronic components in a static-dissipative surface or static-shielded bag when they are not in the chassis.

1.2 Packing List

- 1 x EPC-EHL Intel® Elkhart Lake Fanless Compact System
- Other Major components Other major components include the followings:
 - 2 x Wall mount bracket
 - 1 x DP to VGA Converter
 - 1 x Screw Kit
 - 1 x Adapter



If any of the above items is damaged or missing, contact your retailer.

1.3 System Specifications

Component	
SBC	<ul style="list-style-type: none"> ECM-EHL
CPU	<ul style="list-style-type: none"> Intel Atom® x6413E Processor (1.5M Cache, up to 3.00 GHz)
Memory	<ul style="list-style-type: none"> One 260-pin SO-DIMM Socket, Supports Up to 32GB DDR4 3200MTs SDRAM
BIOS	<ul style="list-style-type: none"> AMI BIOS, 128Mbit SPI Flash ROM
Watchdog Timer	<ul style="list-style-type: none"> H/W Reset, 1sec. ~ 65535sec.
H/W Status Monitor	<ul style="list-style-type: none"> Monitoring System Temperature and Voltage with Auto Throttling Control
TPM	<ul style="list-style-type: none"> TPM 2.0 NuvoTon_NPCT754AADYX
Expansion	
M.2	<ul style="list-style-type: none"> 1 x M.2 (Key-B, 2242/3042, PCIe2, or (PCIe1+USB3.1 GEN1), or (SATAIII + USB 3.1 GEN1), USB2.0, w/SIM Slot for LTE Cards) *Default is PCIe1/SATAIII+USB3.1 GEN1, others through BIOS Modification. 1 x M.2 (Key-E, 2230, PCIe1, USB2.0)
Storage	
Storage	<ul style="list-style-type: none"> 1 x 2.5" Drive Bay (7mm) 1 x M.2 (2242) Key-B
Display	
Graphic Chipset	<ul style="list-style-type: none"> Intel® Elkhart Lake SoC Processor integrated Gen11 LP graphics
Spec. & Resolution	<ul style="list-style-type: none"> 1 x HDMI 2.0b Max resolution 4096 x 2160@60Hz 1 x DP 1.4a Max resolution 4096 x 2160@60Hz
Multiple Display	<ul style="list-style-type: none"> Dual Display
Front I/O	
Button	<ul style="list-style-type: none"> 1 x Power Button
LED Indicator	<ul style="list-style-type: none"> 1 x Power on/off LED 1 x Storage Access LED
Rear I/O	
USB	<ul style="list-style-type: none"> 2 x USB 3.1, 2 x USB2.0
COM	<ul style="list-style-type: none"> 4 x RS232
LAN	<ul style="list-style-type: none"> 2 x RJ45
Antenna	<ul style="list-style-type: none"> 4 x Antenna Mounting with Dust Protection Cover
Audio	<ul style="list-style-type: none"> 1 x Mic-in, 1 x Line-out
Display	<ul style="list-style-type: none"> 1 x HDMI, 1 x DP
LED Indicator	<ul style="list-style-type: none"> 1 x Power on/off LED

EPC-EHL

	<ul style="list-style-type: none"> 1 x Storage Access LED
Audio	
Chipset	<ul style="list-style-type: none"> 92HD73C, TEMPO(TSI)
Interface	<ul style="list-style-type: none"> 1 x Mic-in, 1 x Line-out
Ethernet	
LAN Chipset	<ul style="list-style-type: none"> Intel® I225-IT, Intel® I210-IT
Ethernet Spec.	<ul style="list-style-type: none"> 1 x 10/100/1000/2.5G Base-Tx GbE compatible 1 x 10/100/1000 Base-Tx GbE compatible
Mechanical & Environment	
Power Requirement	<ul style="list-style-type: none"> Typical +9~36Vdc in Lockable DC Jack
ACPI	<ul style="list-style-type: none"> Single Power ATX Support S0, S3, S4, S5 ACPI 5.0 Compliant
Power Type	<ul style="list-style-type: none"> AT/ATX (ATX is default setting)
Operating Temperature	<ul style="list-style-type: none"> Wide Temperature: -40°C ~ 60°C (-40°F ~ 140°F) with 0.2m/s air flow Wide Temperature: -40°C ~ 70°C (-40°F ~ 158°F) with 0.5m/s air flow
Storage Temperature	<ul style="list-style-type: none"> -40°C ~ 75°C (-40°F ~ 167°F)
Operating Humidity	<ul style="list-style-type: none"> 40°C @ 95% Relative Humidity, Non-condensing
Weight	<ul style="list-style-type: none"> 2.65 lbs (1.2KG)
Construction	<ul style="list-style-type: none"> Aluminum + Metal
Mounting Kit	<ul style="list-style-type: none"> Wall Mount Kit (Default)
Dimension (L x W x H)	<ul style="list-style-type: none"> 177 x 123 x 65mm
Vibration Test	<ul style="list-style-type: none"> Random Vibration Operation 1 Test PSD : 0.0505G²/Hz , 5 Grms 2 System condition : operation mode 3 Test frequency : 10~500 Hz 4 Test axis : X,Y and Z axis 5 Test time : 30 minutes per each axis 6 IEC60068-2-64 Test Fh 6 Storage : 2.5"SSD/HDD Sine Vibration test (Non-operation) 1 Test Acceleration : 2G 2 Test frequency : 5~500 Hz 3 Sweep : 1 Oct/ per one minute. (logarithmic) 4 Test Axis : X,Y and Z axis 5 Test time :30 min. each axis 6 System condition : Non-Operating mode 7. Reference IEC 60068-2-6 Testing procedures

	<ul style="list-style-type: none"> • Package Vibration Test: • 1 Test PSD : 0.026G²/Hz , 2.16 Grms • 2 Test frequency : 5~500 Hz • 3 Test axis : X,Y and Z axis • 4 Test time : 30 minutes per each axis • 5 IEC 60068-2-64 Test Fh
Shock Test	<ul style="list-style-type: none"> • 1 Wave from : Half Sine wave • 2 Acceleration Rate : 55G • 3 Duration Time : 11ms • 4 No. of shock : 3 times • 5 Test Axis : +/- X, +/-Y, +/-Z axis • 6 operation mode • 7 Reference IEC 60068-2-27 testing procedures • Test Eb : SSD Shock Test
Drop	<ul style="list-style-type: none"> • Package drop test • Reference ISTA 2A, Method : IEC-60068-2-32 Test:Ed • Test Ea : Drop Test • 1 Test phase : One corner, three edges, six faces • 2 Test high : 96.5cm • 3 Package weight : 5Kg • 4 Test drawing
Software Support	
OS Information	<ul style="list-style-type: none"> • Win10 64 bit, Linux
Certification	
Certification Information	<ul style="list-style-type: none"> • CE, FCC Class B
Power Requirement	
Adapter	<ul style="list-style-type: none"> • Input: 100 ~ 240Vdc/ 50 ~ 60Hz • Output: 12V/5A AC-DC 60W Adapter

➤ **Extended SKU**

- **Din Rail (EPC-EHL-DIN)**

Front I/O	
USB	2 x USB 3.1, 2 x USB2.0
COM	4 x RS232
LAN	2 x RJ45
Antenna	4 x Antenna Mounting with Dust Protection Cover
Power	1 x Power Switch
LED Indicator	1 x Power on/off LED, 1 x Storage Access LED
DC Connector	1 x DC Jack

- **8-USB (EPC-EHL-8USB)**

Front I/O	
Button	1 x Power Button
USB	2 x USB 3.1, 4 x USB2.0 (Daughter board EPM-1604)
LED Indicator	1 x Power on/off LED, 1 x Storage Access LED
Front I/O	
USB	2 x USB 3.1, 2 x USB2.0
COM	4 x RS232
LAN	2 x RJ45
Antenna	2 x Antenna Mounting with Dust Protection Cover
Audio	1 x Mic-in, 1 x Line-out
Display	1 x HDMI, 1 x DP
LED Indicator	1 x Power on/off LED, 1 x Storage Access LED

- **8-COM (EPC-EHL-8COM)**

Front I/O	
Button	1 x Power Button
USB	2 x USB 3.1, 4 x COM (Daughter board EPM-1607)
LED Indicator	1 x Power on/off LED, 1 x Storage Access LED
Front I/O	
USB	2 x USB 3.1, 2 x USB2.0
COM	4 x RS232
LAN	2 x RJ45
Antenna	2 x Antenna Mounting with Dust Protection Cover
Audio	1 x Mic-in, 1 x Line-out
Display	1 x HDMI, 1 x DP

LED Indicator	1 x Power on/off LED, 1 x Storage Access LED
----------------------	--

- **4-LAN (EPC-EHL-4LAN)**

Front I/O	
Button	1 x Power Button
LED Indicator	1 x Power on/off LED, 1 x Storage Access LED
Front I/O	
USB	2 x USB 3.1, 2 x USB2.0
COM	2 x RS232
LAN	4 x RJ45 (Daughter board EPM-1608)
Antenna	2 x Antenna Mounting with Dust Protection Cover
Audio	1 x Mic-in, 1 x Line-out
Display	1 x HDMI, 1 x DP
LED Indicator	1 x Power on/off LED, 1 x Storage Access LED



Note: Specifications are subject to change without notice.

1.4 System Overview

1.4.1 Front View/Side View

EPC-EHL

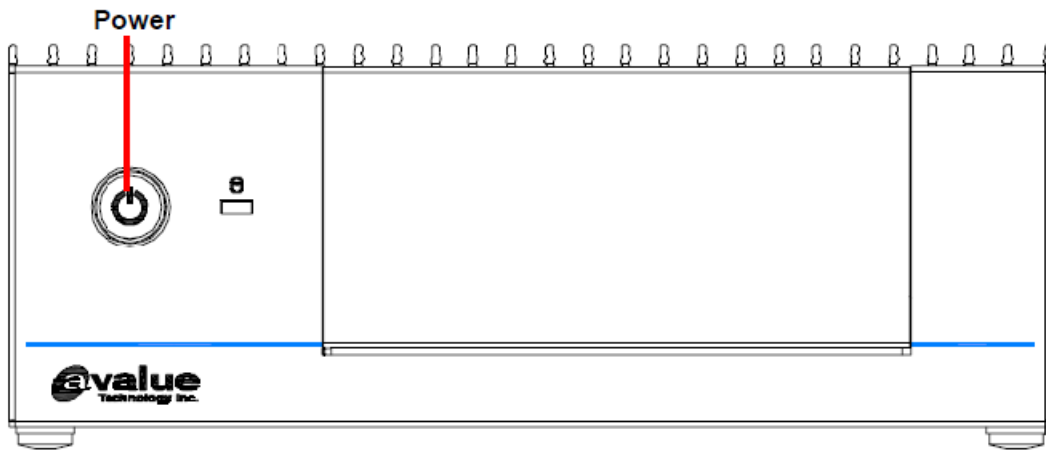

EPC-EHL-8USB

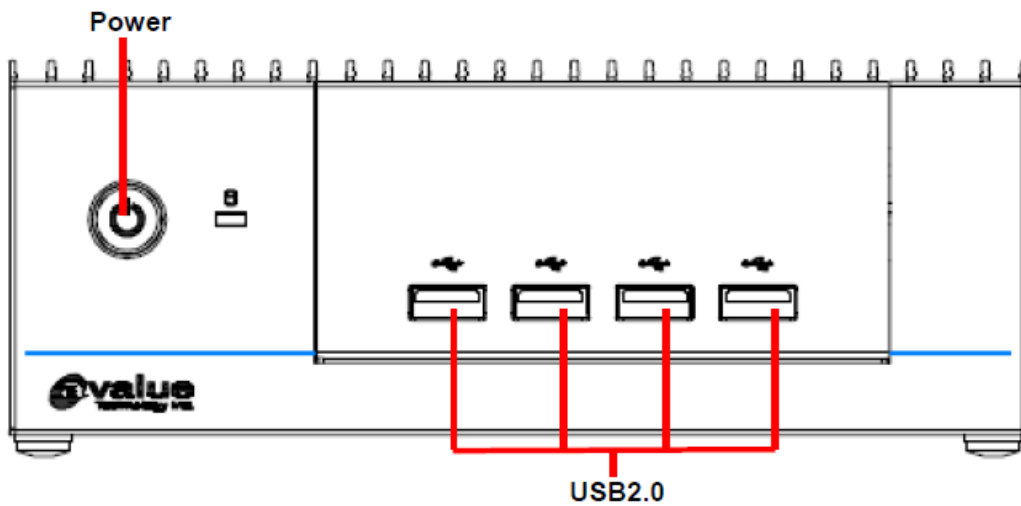

EPC-EHL-8COM

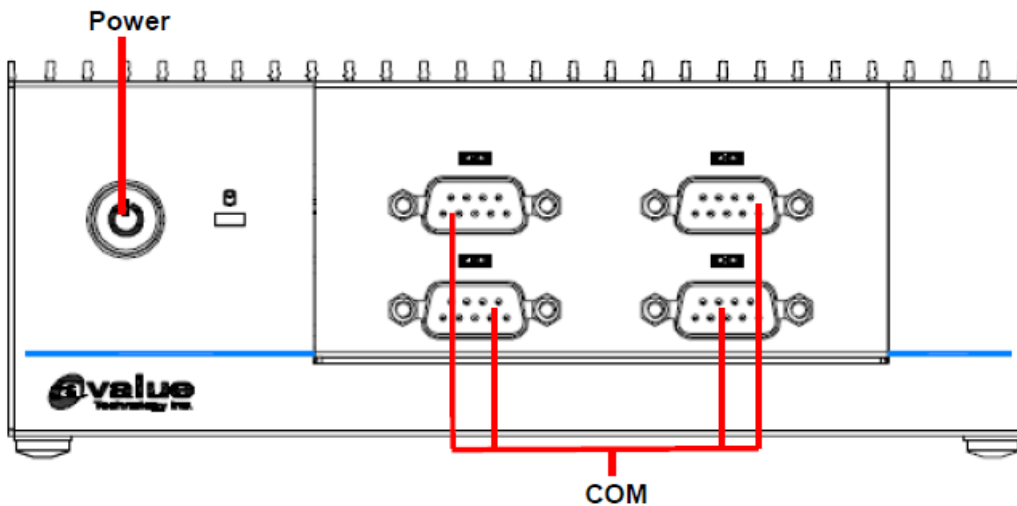

EPC-EHL-4LAN

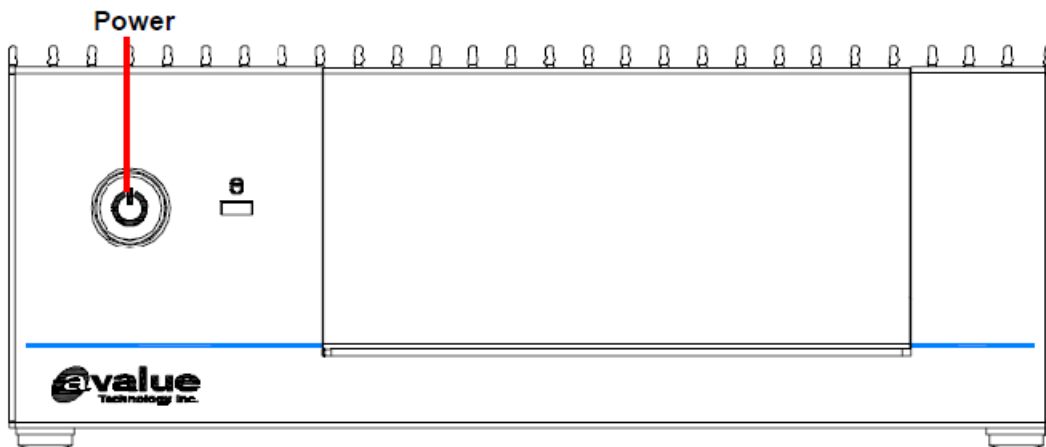

EPC-EHL-DIN

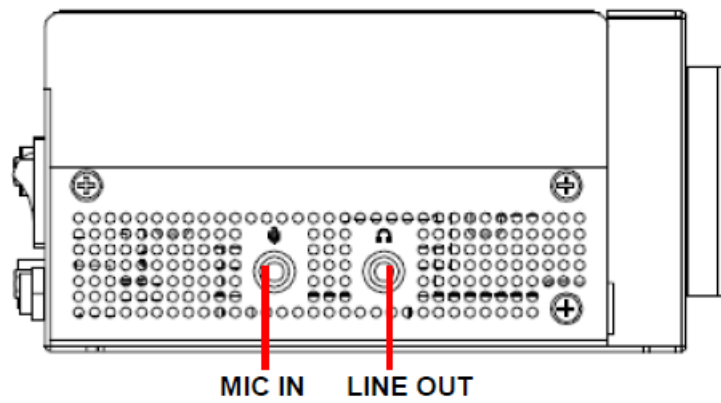

1.4.2 Rear View

EPC-EHL

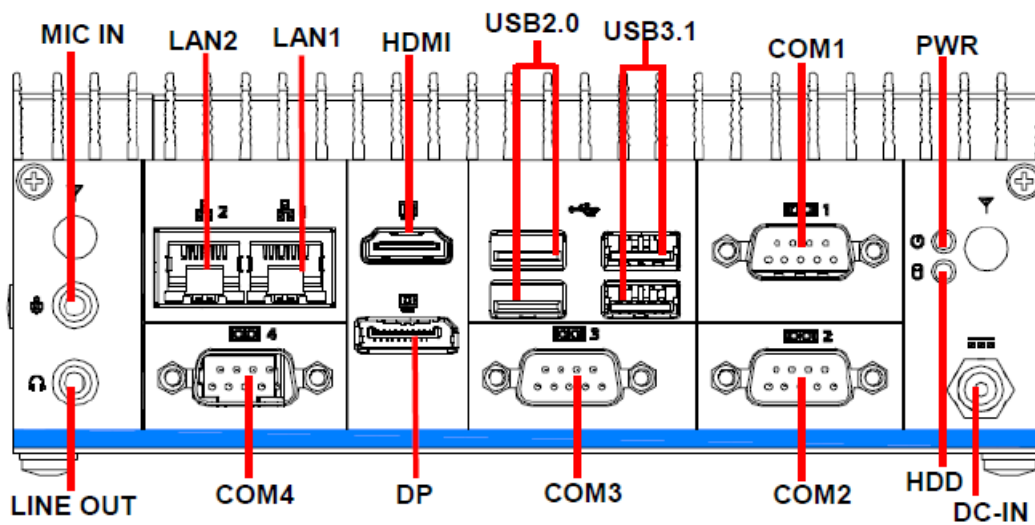

EPC-EHL-DIN

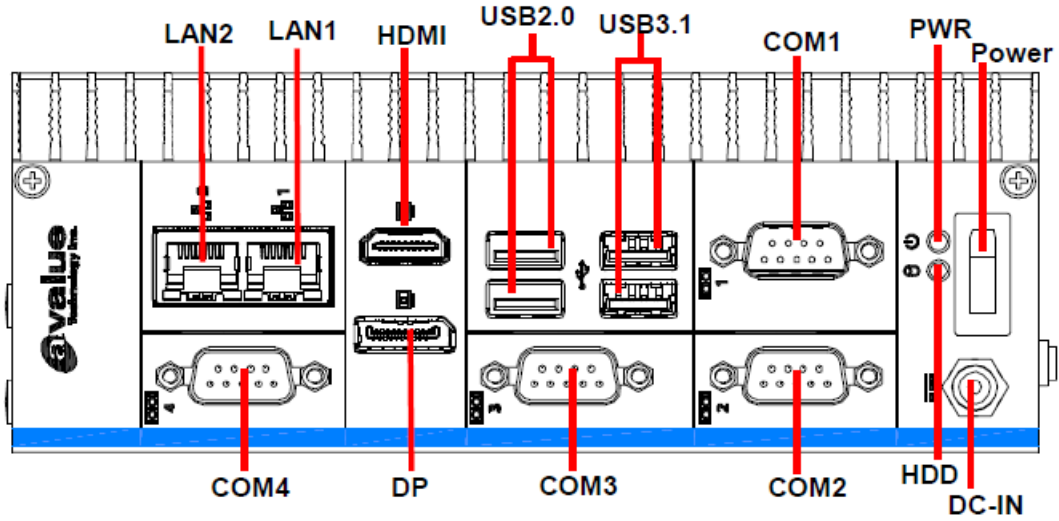

EPC-EHL-8USB

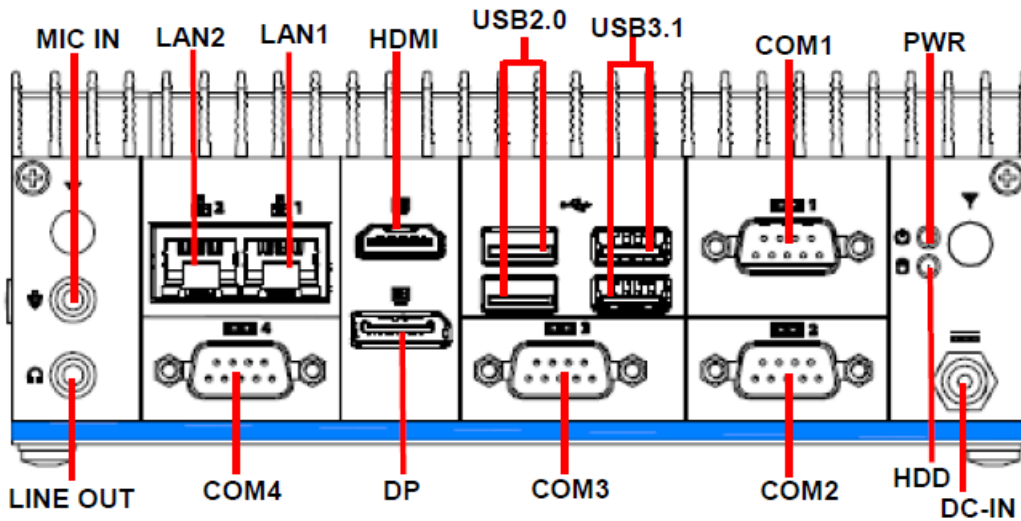

EPC-EHL-8COM

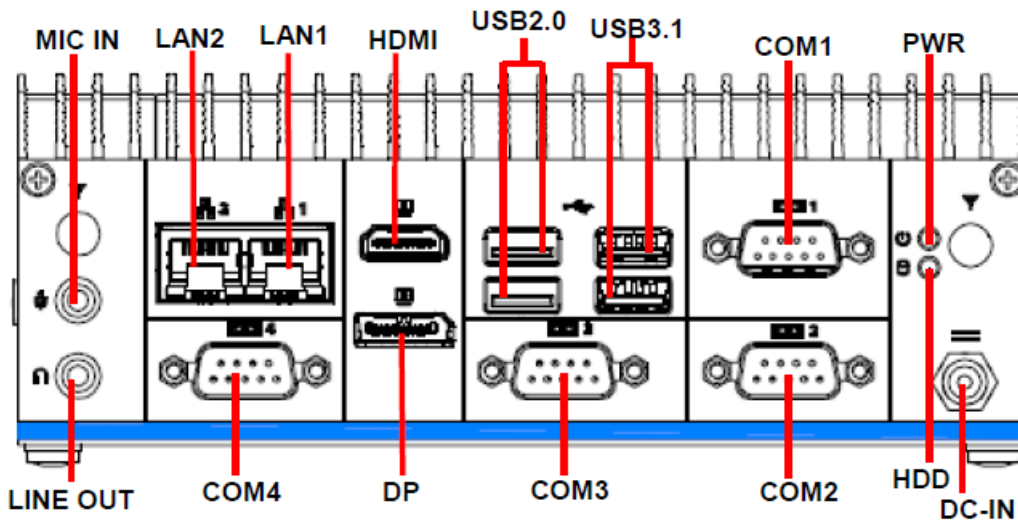

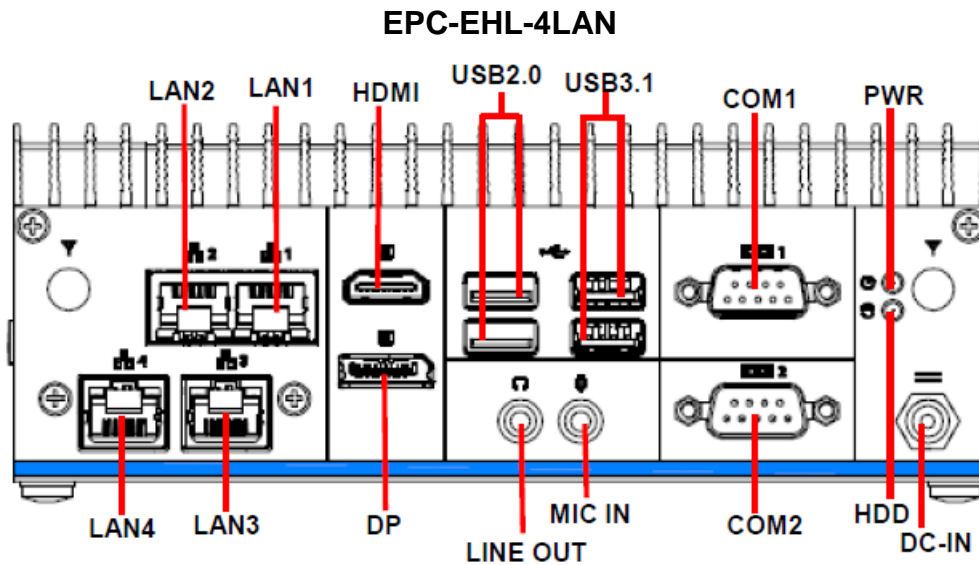
**EPC-EHL****Connectors**

Label	Function	Note
Power	Power on button	
HDD	HDD indicator	
PWR	System power indicator	
LAN1/2	RJ-45 Ethernet x 2	
COM1/2/3/4	Serial port connector x 4	
USB2.0	USB 2.0 connector x 2	
USB3.1	USB 3.1 connector x 2	
HDMI	HDMI connector	
DP	DP connector	
DC-IN	DC Power-in connector	
LINE OUT	Line-out audio jack	
MIC IN	Mic-in audio jack	

EPC-EHL-DIN**Connectors**

Label	Function	Note
Power	Power Switch	
HDD	HDD indicator	
PWR	System power indicator	
LAN1/2	RJ-45 Ethernet x 2	

EPC-EHL

COM1/2/3/4	Serial port connector x 4
USB2.0	USB 2.0 connector x 2
USB3.1	USB 3.1 connector x 2
HDMI	HDMI connector
DP	DP connector
DC-IN	DC Power-in connector
LINE OUT	Line-out audio jack
MIC IN	Mic-in audio jack

EPC-EHL-8USB

Connectors

Label	Function	Note
Power	Power on button	
HDD	HDD indicator	
PWR	System power indicator	
LAN1/2	RJ-45 Ethernet x 2	
COM1/2/3/4	Serial port connector x 4	
USB2.0	USB 2.0 connector x 6	
USB3.1	USB 3.1 connector x 2	
HDMI	HDMI connector	
DP	DP connector	
DC-IN	DC Power-in connector	
LINE OUT	Line-out audio jack	
MIC IN	Mic-in audio jack	

EPC-EHL-8COM

Connectors

Label	Function	Note
Power	Power on button	
HDD	HDD indicator	
PWR	System power indicator	
LAN1/2	RJ-45 Ethernet x 2	
COM	Serial port connector x 8	
USB2.0	USB 2.0 connector x 2	
USB3.1	USB 3.1 connector x 2	
HDMI	HDMI connector	

DP	DP connector
DC-IN	DC Power-in connector
LINE OUT	Line-out audio jack
MIC IN	Mic-in audio jack

EPC-EHL-4LAN**Connectors**

Label	Function	Note
Power	Power on button	
HDD	HDD indicator	
PWR	System power indicator	
LAN1/2/3/4	RJ-45 Ethernet x 4	
COM1/2	Serial port connector x 2	
USB2.0	USB 2.0 connector x 2	
USB3.1	USB 3.1 connector x 2	
HDMI	HDMI connector	
DP	DP connector	
DC-IN	DC Power-in connector	
LINE OUT	Line-out audio jack	
MIC IN	Mic-in audio jack	

1.5 System Dimensions

1.5.1 EPC-EHL Front & Top View

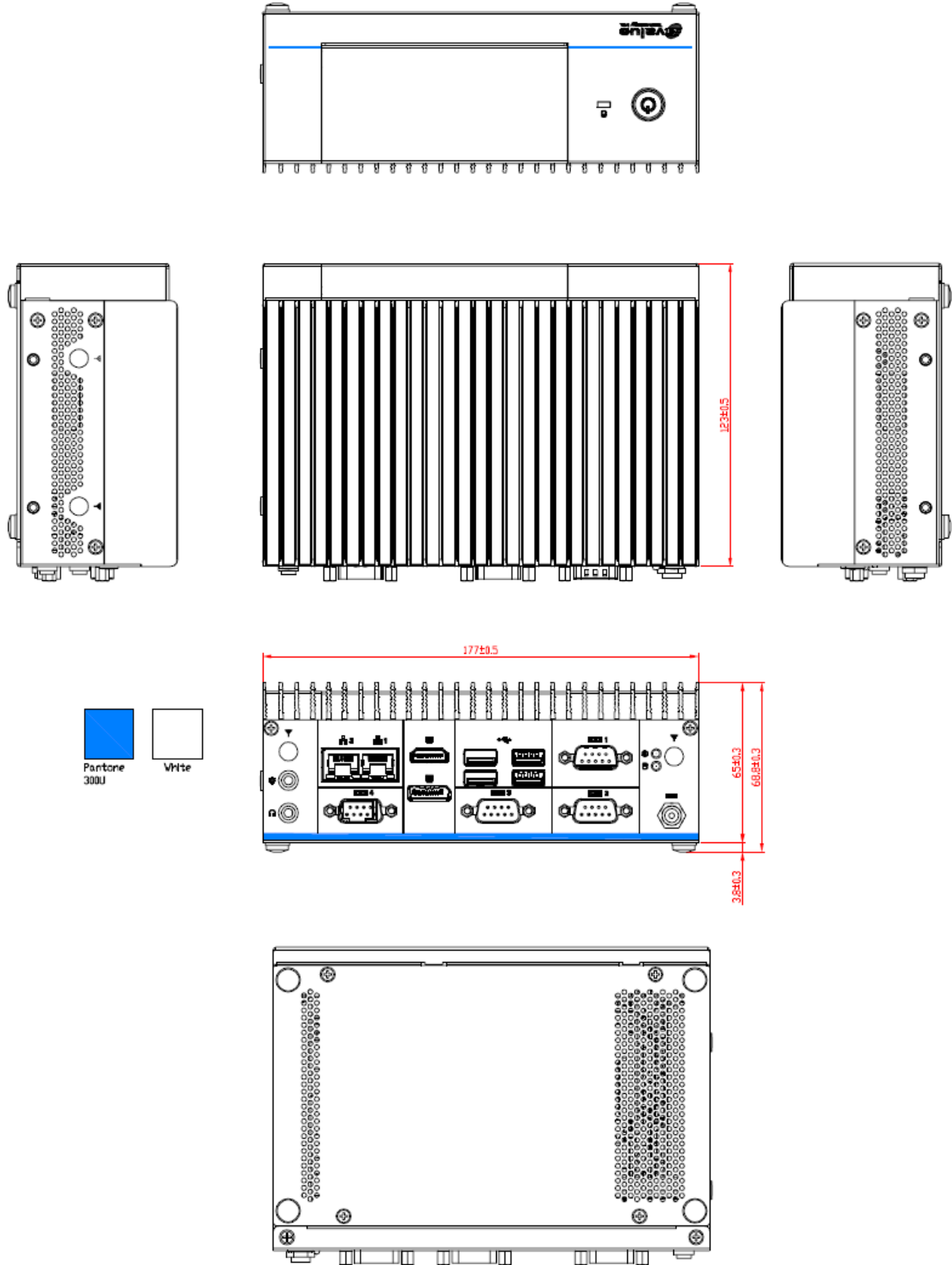

(Unit: mm)

1.5.2 EPC-EHL-DIN Front & Top View

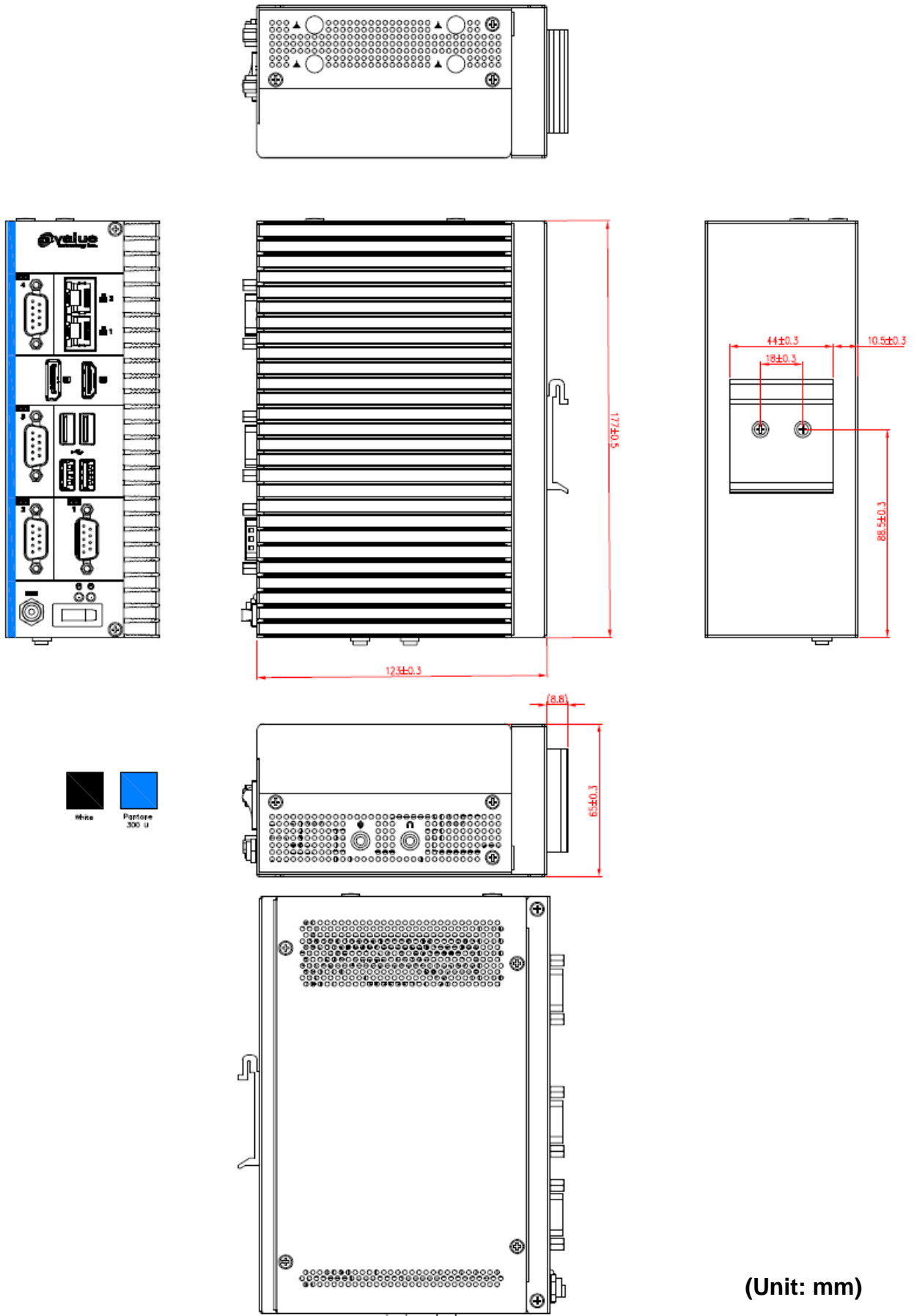

(Unit: mm)

EPC-EHL

1.5.3 EPC-EHL-8USB Front & Top View

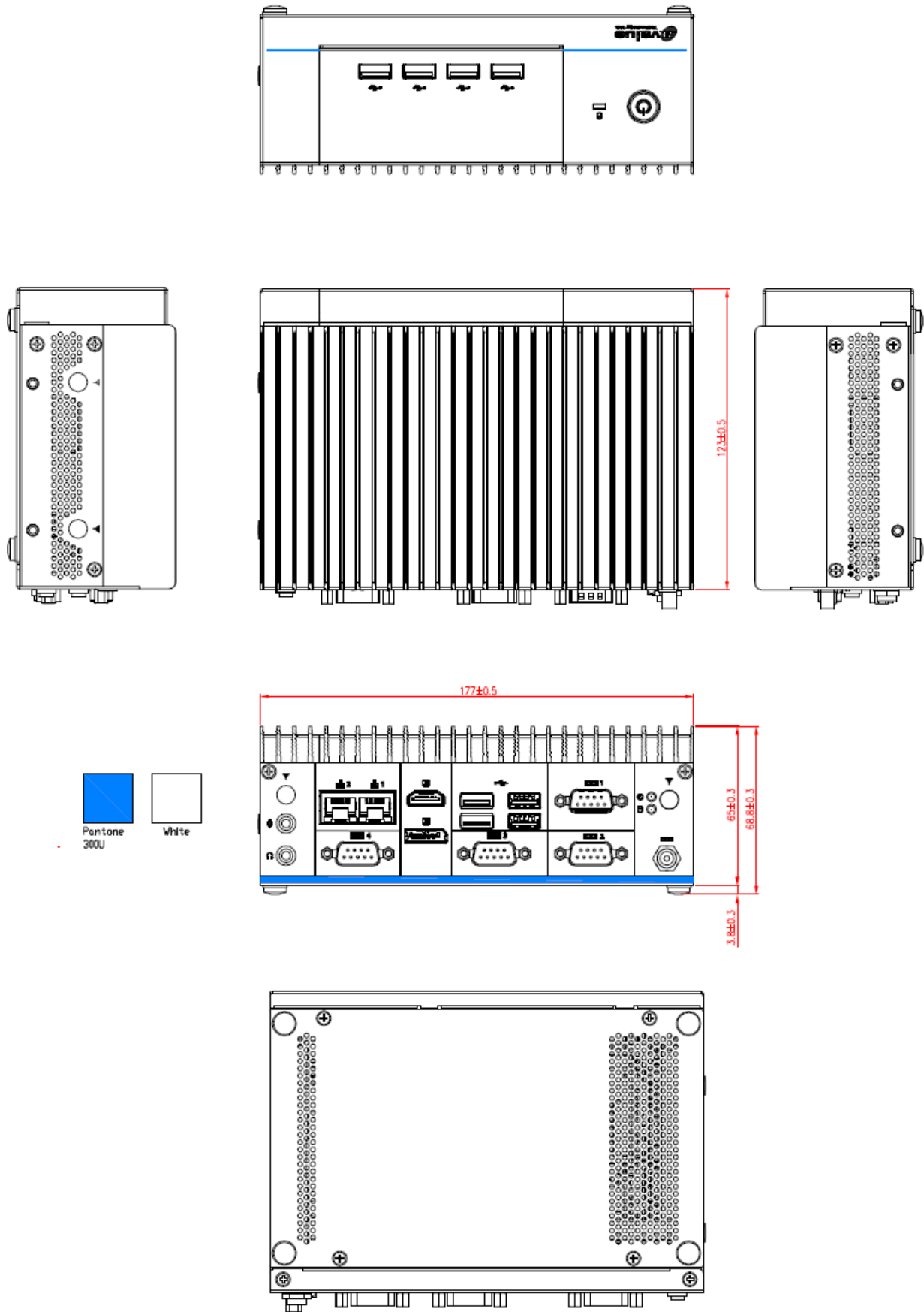

(Unit: mm)

1.5.4 EPC-EHL-8COM Front & Top View

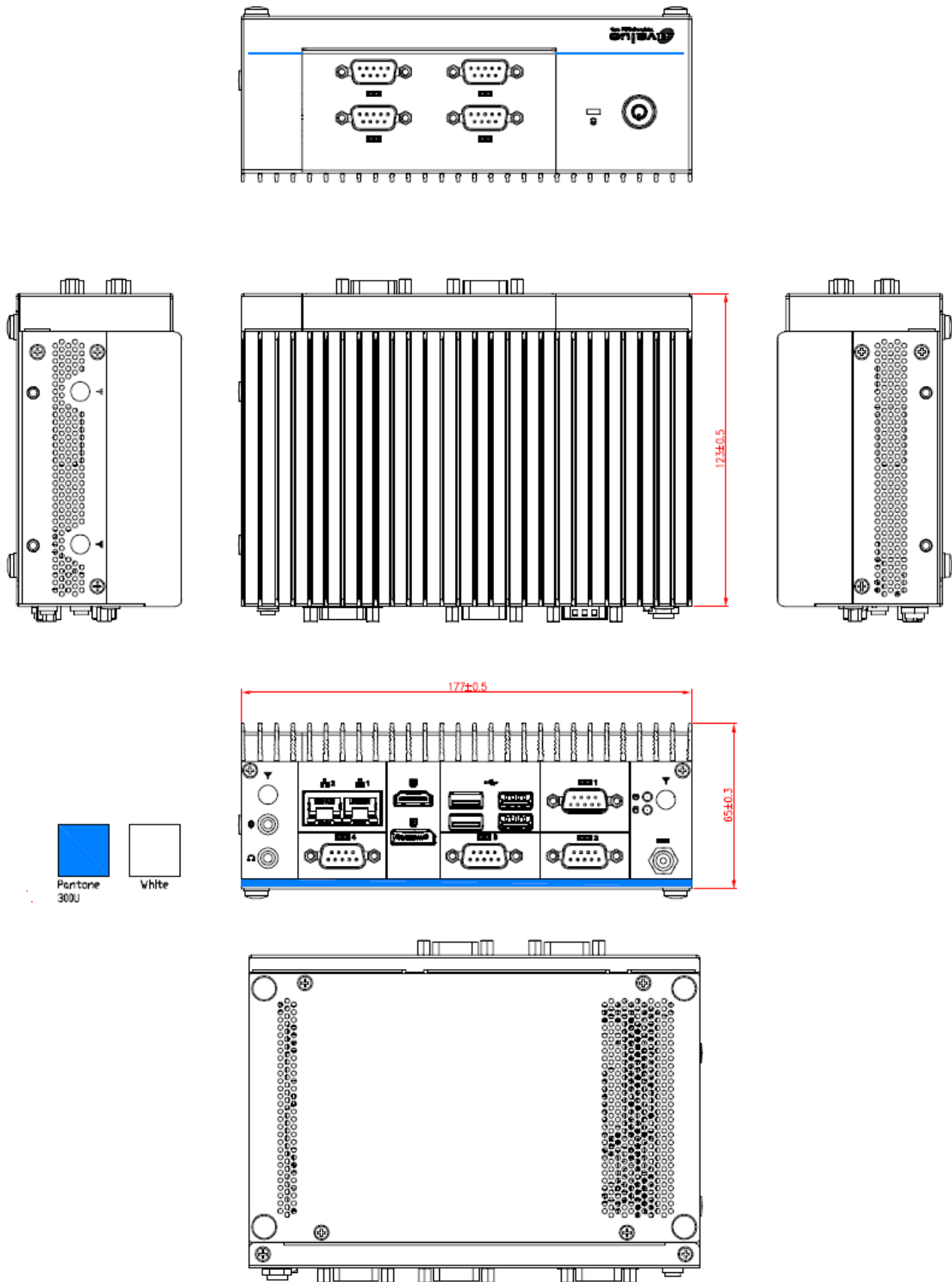

(Unit: mm)

EPC-EHL

1.5.5 EPC-EHL-4LAN Front & Top View

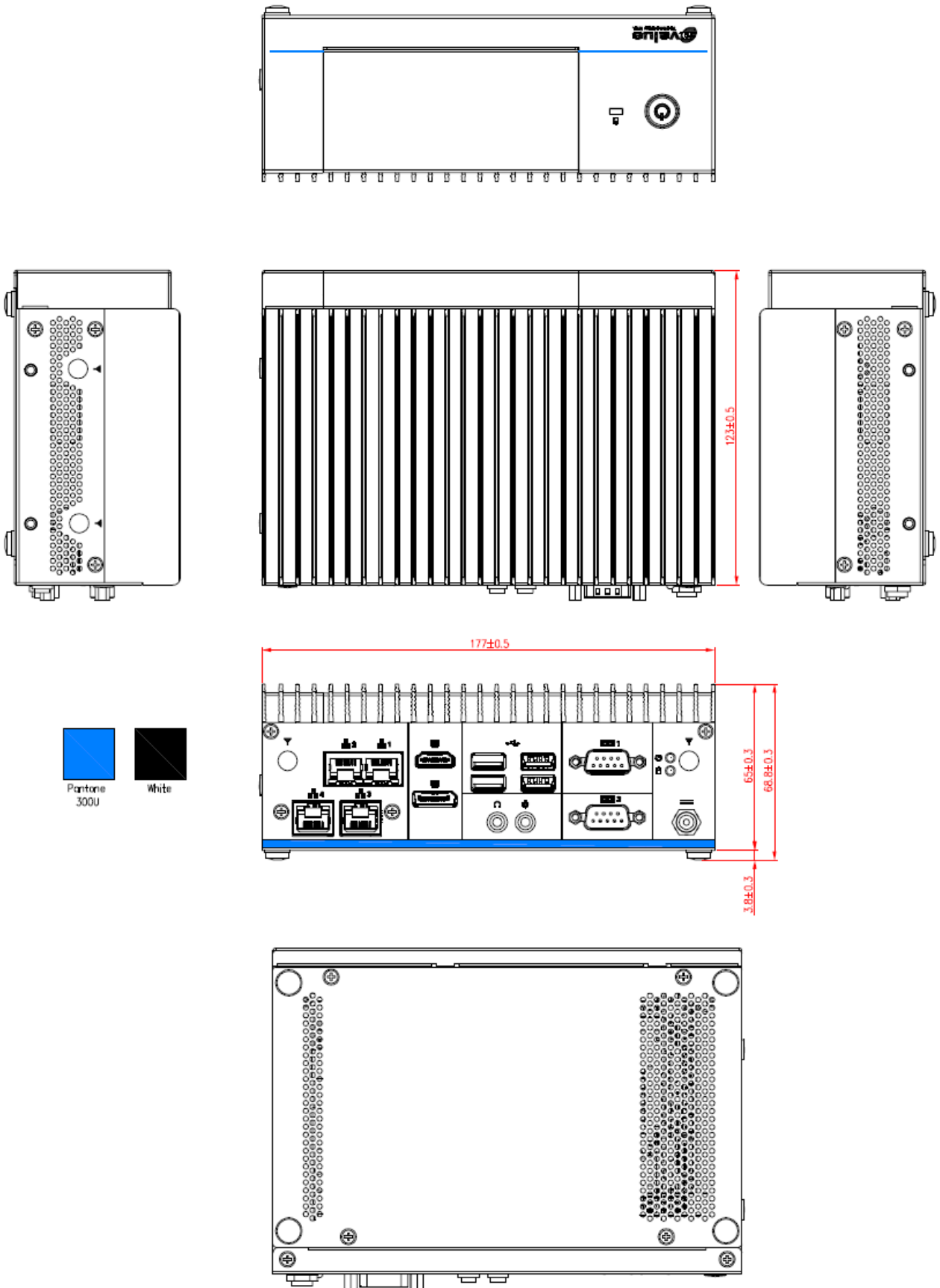

(Unit: mm)

2. Hardware Configuration

For advanced information, please refer to:

- 1- ECM-EHL included in this manual



Note: If you need more information, please visit our website:

<http://www.avalue.com.tw>

2.1 EPC-EHL connector mapping

2.1.1 Serial Port connector (COM)

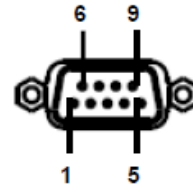
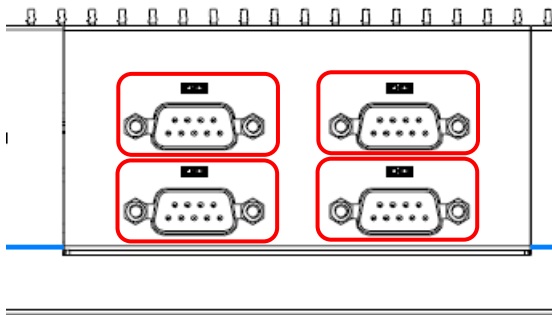
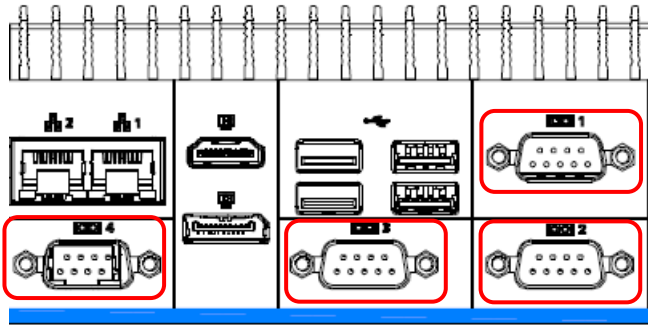

Signal	PIN	PIN	Signal
DCD#	1	6	DSR#
RXD	2	7	RTS#
TXD	3	8	CTS#
DTR#	4	9	RI#
GND	5		

2.2 ECM-EHL Product Overview

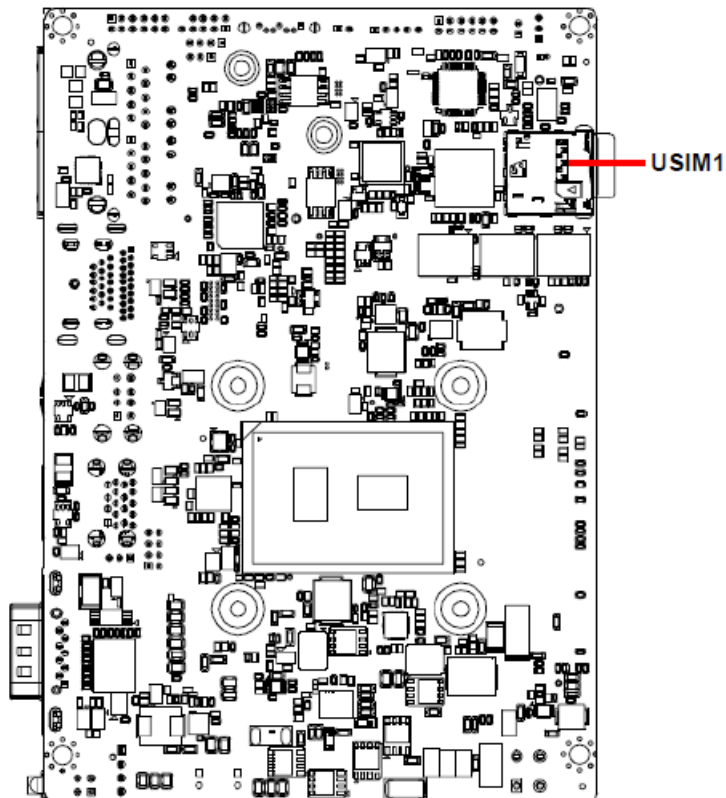
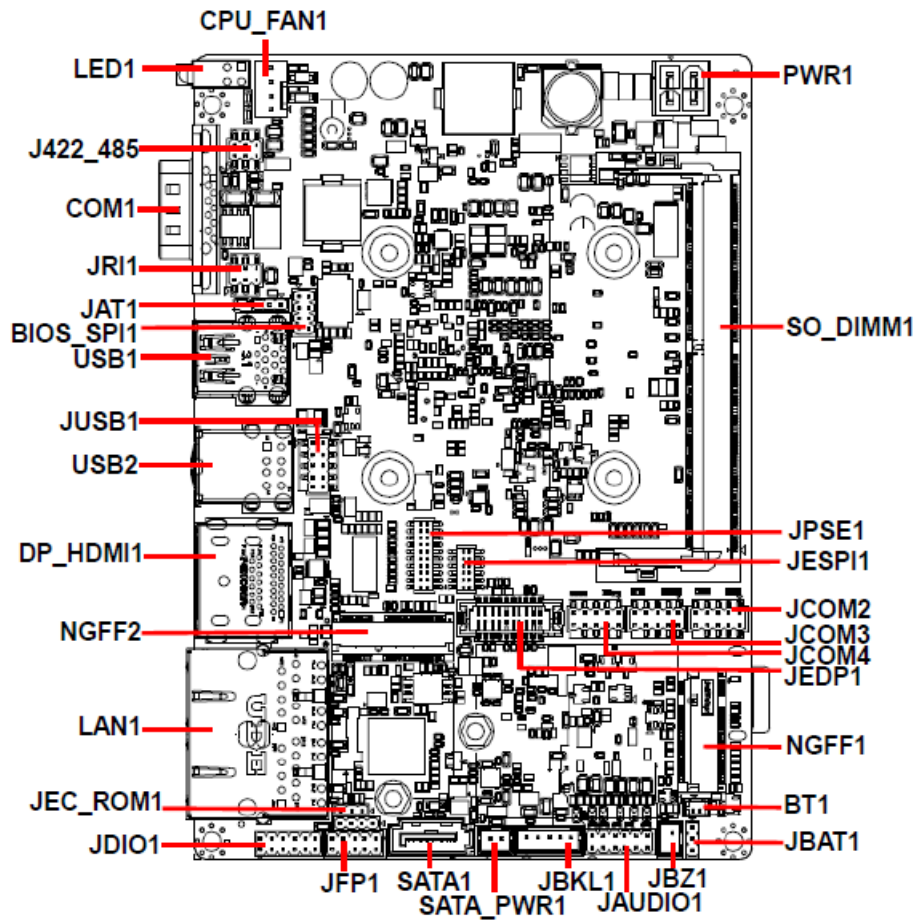

2.3 ECM-EHL Jumper and Connector List

You can configure your board to match the needs of your application by setting jumpers. A jumper is the simplest kind of electric switch.

It consists of two metal pins and a small metal clip (often protected by a plastic cover) that slides over the pins to connect them. To “close” a jumper you connect the pins with the clip. To “open” a jumper you remove the clip. Sometimes a jumper will have three pins, labeled 1, 2, and 3. In this case, you would connect either two pins.

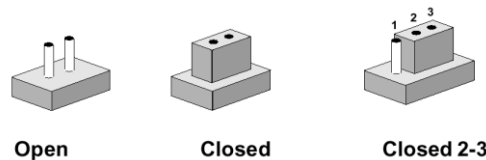

The jumper settings are schematically depicted in this manual as follows:



A pair of needle-nose pliers may be helpful when working with jumpers.

Connectors on the board are linked to external devices such as hard disk drives, a keyboard, or floppy drives. In addition, the board has a number of jumpers that allow you to configure your system to suit your application.

If you have any doubts about the best hardware configuration for your application, contact your local distributor or sales representative before you make any changes.

The following tables list the function of each of the board’s jumpers and connectors.

Jumpers

Label	Function	Note
JRI1	Serial port 1 pin9 signal select	3 x 2 header, pitch 2.00mm
JAT1	AT/ATX Input power select	3 x 1 header, pitch 2.00mm
JBAT1	Clear CMOS	3 x 1 header, pitch 2.00mm

Connectors

Label	Function	Note
JBKL1	LCD inverter connector	5 x 1 wafer, pitch 2.00mm Matching Connector: JST PHR-5
CPU_FAN1	CPU fan connector	4 x 1 wafer, pitch 2.54mm
COM1	Serial Port 1 connector	D-sub 9-pin, male Note : COM1 support RS422/485 by BIOS setting
J422_485	Serial port 1 in RS-422/485 mode	3 x 2 header, pitch 2.00 mm

Quick Reference Guide

JCOM2/3/4	Serial Port 2/3/4 connector	5 x 2 header, pitch 2.00mm
JDIO1	General purpose I/O connector	6 x 2 wafer, pitch 2.00mm
NGFF1	M.2 KEY-B 2242/3042 connector	
NGFF2	M.2 KEY-E 2230 connector	
LED1	HDD/Power LED indicator	
JFP1	Front Panel connector	5 x 2 header, pitch 2.00mm
USB1	2 x USB3.1 connector	
USB2	2 x USB2.0 connector	
JUSB1	USB2.0 connector	5 x 2 header, pitch 2.00mm
JBZ1	PC Buzzer connector	2 x 1 wafer, pitch 2.00mm
LAN1	2 x RJ-45 Ethernet	
BT1	Battery connector	2 x 1 wafer, pitch 1.25mm
JAUDIO1	Audio connector	6 x 2 header, pitch 2.00mm
PWR1	Power connector	2 x 2 wafer, pitch 4.20mm
BIOS_SPI1	BIOS SPI connector	4 x 2 header, pitch 2.00mm
JEC_ROM1	EC Debug connector	3 x 1 header, pitch 2.00mm
SATA_PWR1	SATA Power connector	2 x 1 wafer, pitch 2.00mm
SATA1	Serial ATA connector	
DP_HDMI1	DP connector HDMI connector	
SO_DIMM1	DDR4 SODIMM socket	
JPSE1	Cortex Debug + ETM connector	10 x 2 header, pitch 1.27mm
JESPI1	Port80 connector	6 x 2 header, pitch 1.27mm
JEDP1	eDP connector	10 x 2 wafer, pitch 1.25mm
USIM1	SIM card slot	

2.4 ECM-EHL Setting Jumpers & Connectors

2.4.1 Serial port 1 pin9 signal select (JRI1)

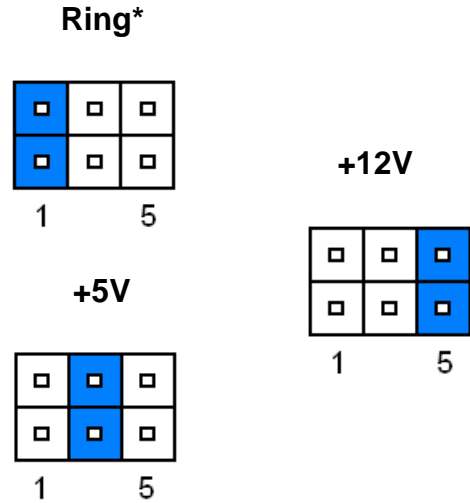
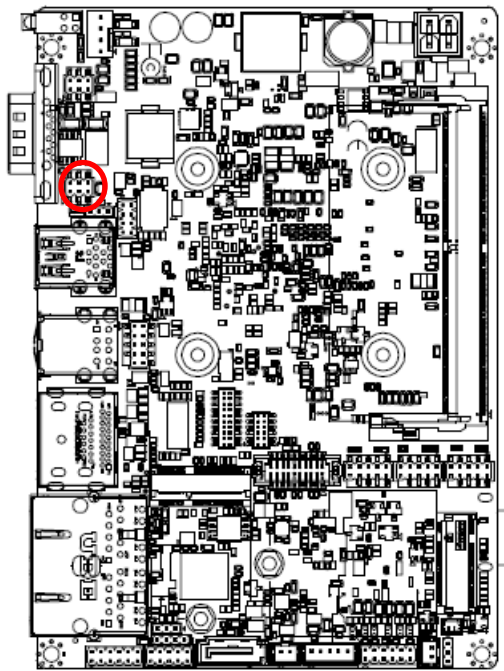

* Default

2.4.2 Clear CMOS (JBAT1)

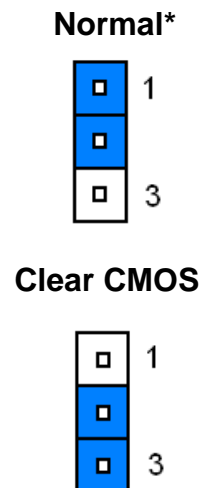
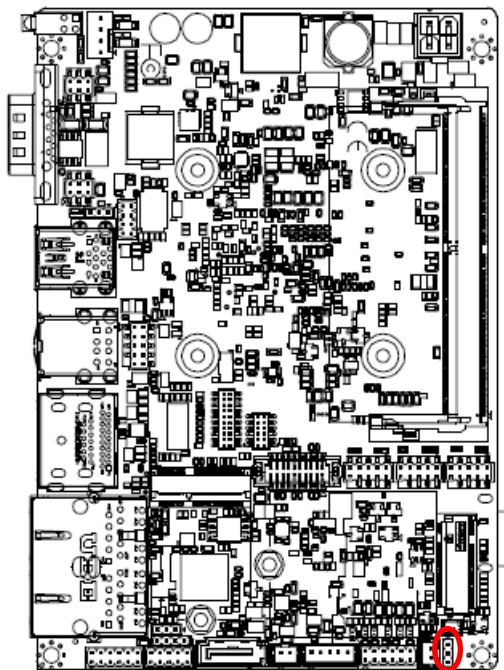

* Default

2.4.3 AT/ATX Input power select (JAT1)

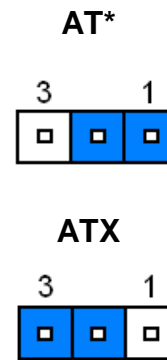
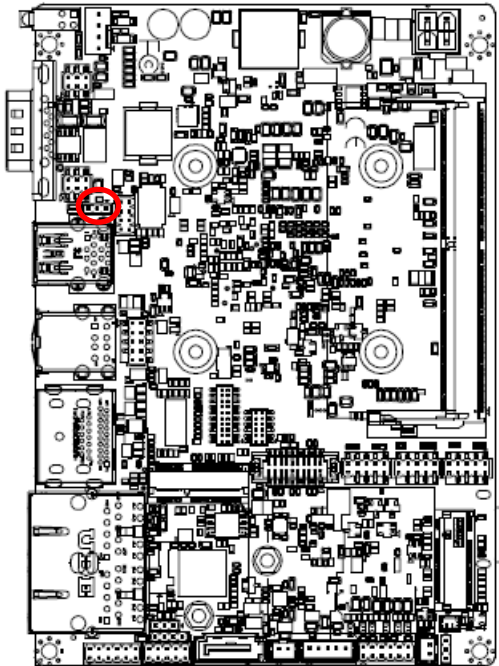

* Default

2.4.4 LCD inverter connector (JBKL1)

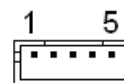
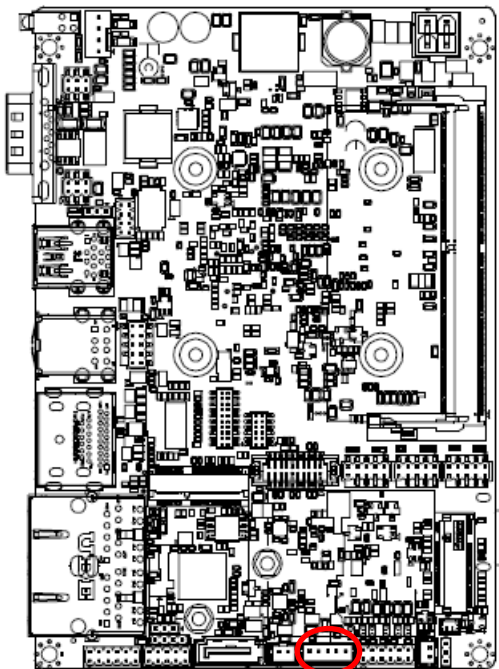

Signal	PIN
+12V	1
GND	2
BKLEN	3
VBRIGHT	4
+5V	5

2.4.5 CPU fan connector (CPU_FAN1)

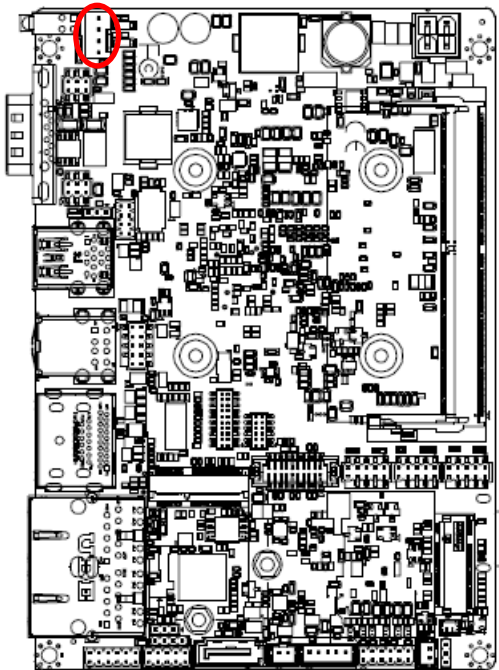

Signal	PIN
CFAN_OUT_PWM	4
CFAN_IN_TACH	3
+12V	2
GND	1

2.4.6 Serial port 1 in RS-422/485 mode (J422_485)

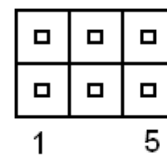
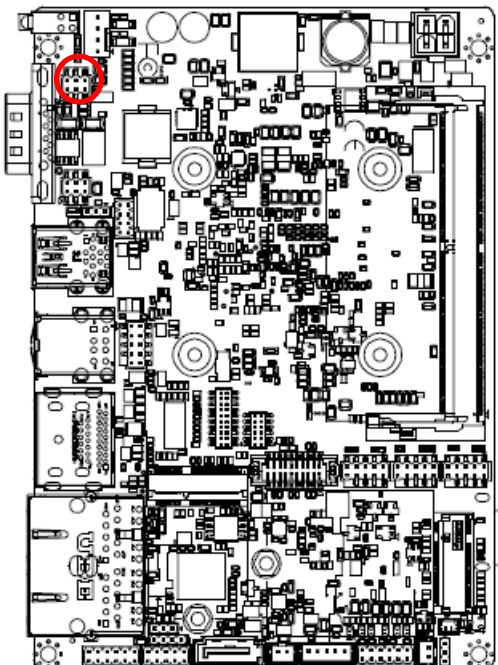

Signal	PIN	PIN	Signal
485TX2-	1	2	485TX2+
485RX2+	3	4	485RX2-
+5V	5	6	GND

2.4.7 Serial port 2 connector (JCOM2)

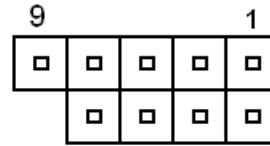
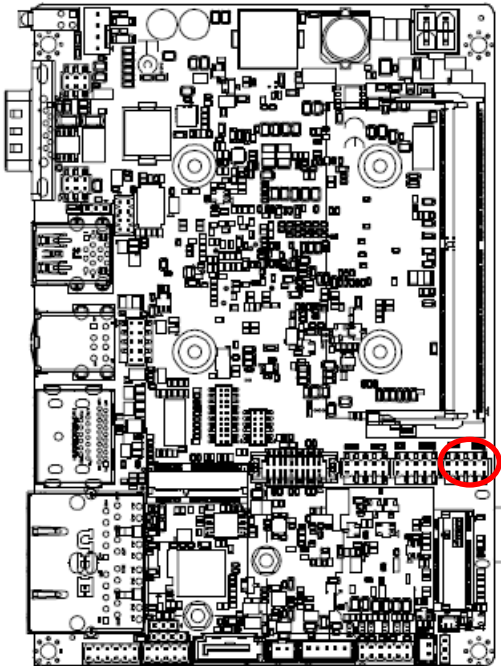

Signal	PIN	PIN	Signal
COM_DCD#_2	1	2	COM_RXD_2
COM_TXD_2	3	4	COM_DTR#_2
GND	5	6	COM_DSR#_2
COM_RTS#_2	7	8	COM_CTS#_2
COM_RI#_2	9		

2.4.8 Serial port 3 connector (JCOM3)

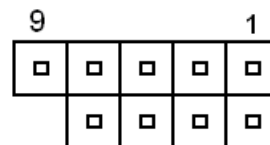
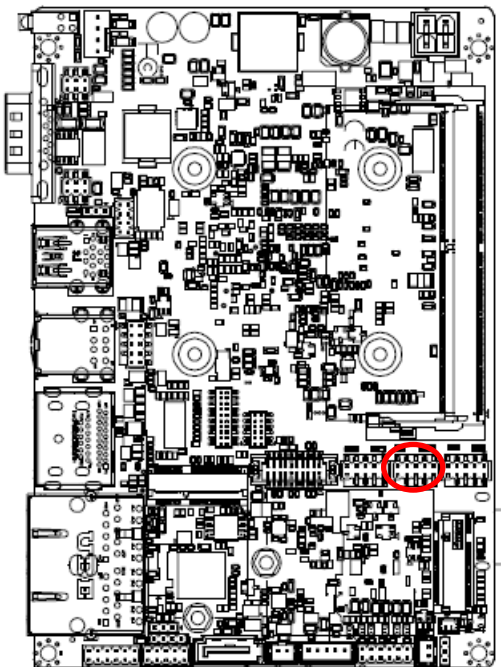

Signal	PIN	PIN	Signal
COM_DCD#_3	1	2	COM_RXD_3
COM_TXD_3	3	4	COM_DTR#_3
GND	5	6	COM_DSR#_3
COM_RTS#_3	7	8	COM_CTS#_3
COM_RI#_3	9		

2.4.9 Serial port 4 connector (JCOM4)

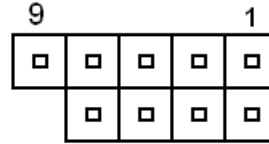
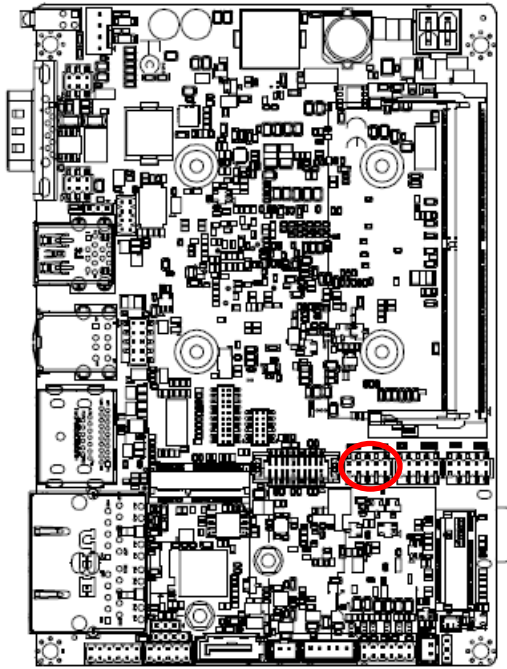

Signal	PIN	PIN	Signal
COM_DCD#_4	1	2	COM_RXD_4
COM_TXD_4	3	4	COM_DTR#_4
GND	5	6	COM_DSR#_4
COM_RTS#_4	7	8	COM_CTS#_4
COM_RI#_4	9		

2.4.10 General purpose I/O connector (JDIO1)

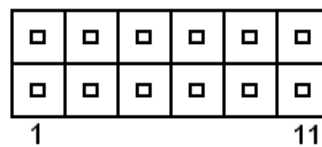
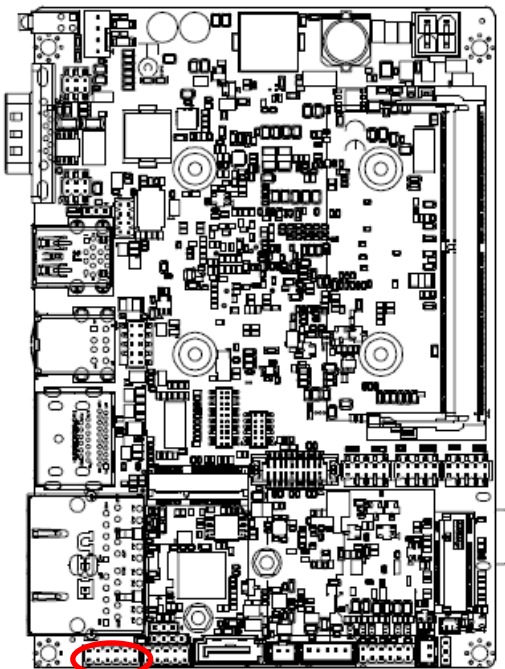

Signal	PIN	PIN	Signal
DIO_GP20_TGPI4	1	2	DIO_GP10_TGPI0
DIO_GP21_TGPI5	3	4	DIO_GP11_TGPI1
DIO_GP22_TGPI6	5	6	DIO_GP12_TGPI2
DIO_GP23_TGPI7	7	8	DIO_GP13_TGPI3
SMB_SCL_S0	9	10	SMB_SDA_S0
GND	11	12	+5V

2.4.11 SATA Power connector (SATA_PWR1)

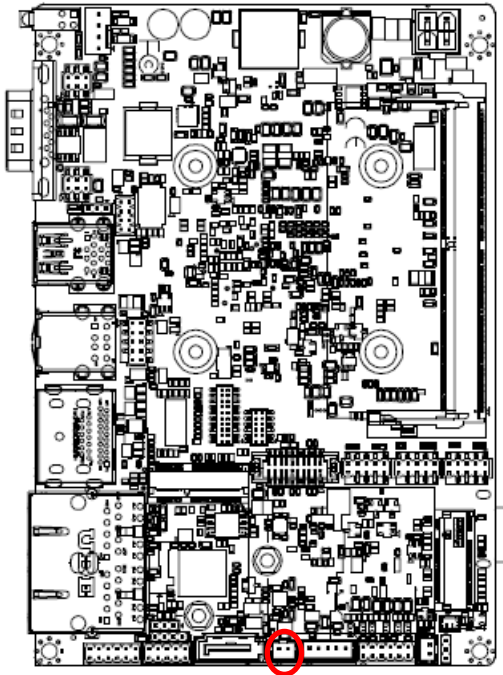

Signal	PIN
GND	1
+5V	2

2.4.12 Power connector (PWR1)

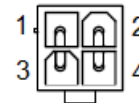
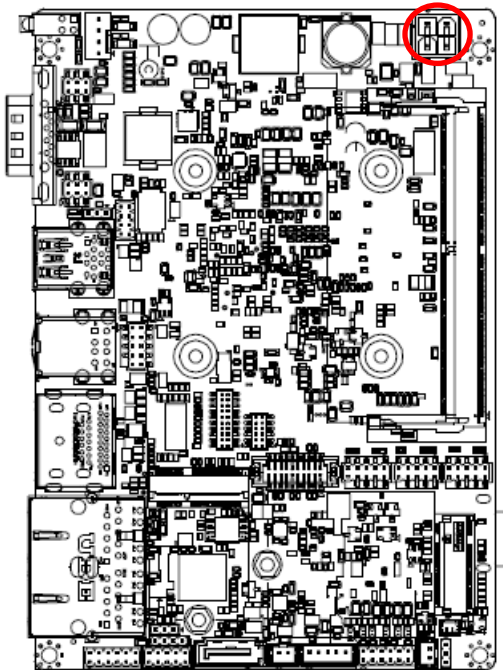

Signal	PIN	PIN	Signal
GND	1	2	GND
+VIN_EXT	3	4	+VIN_EXT

2.4.13 USB2.0 connector (JUSB1)

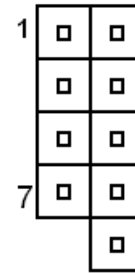
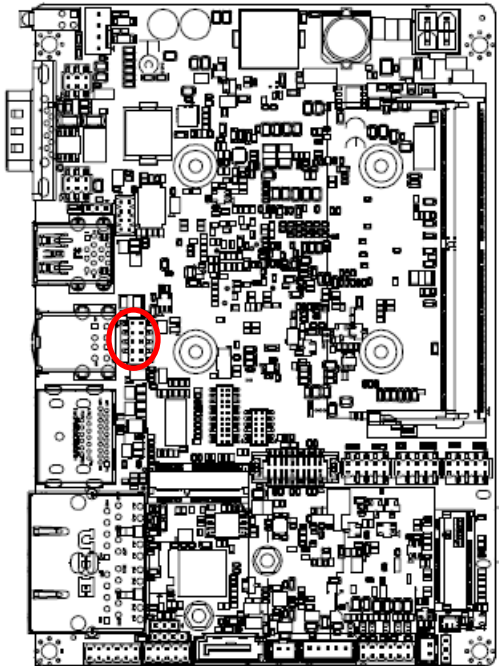

Signal	PIN	PIN	Signal
+5VSB	1	2	+5VSB
USB_R_DN4	3	4	USB_R_DN5
USB_R_DP4	5	6	USB_R_DP5
GND	7	8	GND
		10	GND

2.4.14 BIOS SPI connector (BIOS_SPI1)

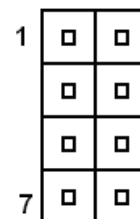
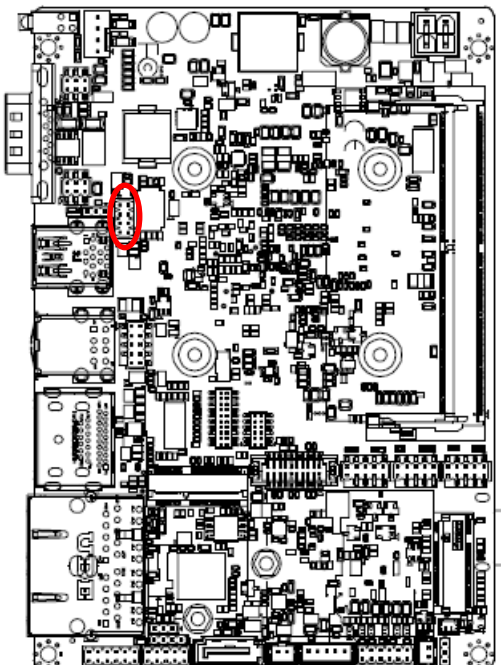

Signal	PIN	PIN	Signal
+3.3VSB	1	2	GND
SPI_CS0#	3	4	SPI_CLK
SPI_MISO	5	6	SPI_MOSI
BIOS_HOLD#	7	8	BIOS_WP#

2.4.15 EC Debug connector (JEC_ROM1)

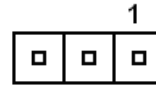
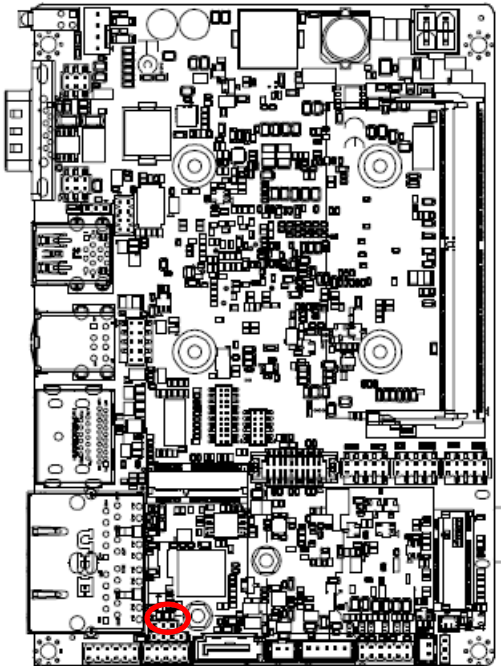

Signal	PIN
EC_SMCLK_DBG	1
EC_SMDAT_DBG	2
GND	3

2.4.16 Battery connector (BT1)

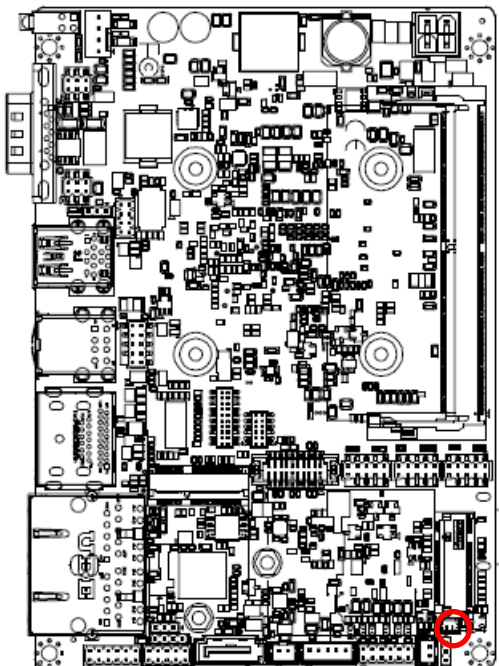

Signal	PIN
+RTCBATT	1
GND	2

2.4.17 Front Panel connector (JFP1)

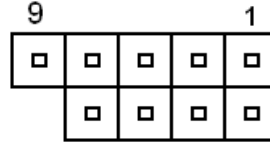
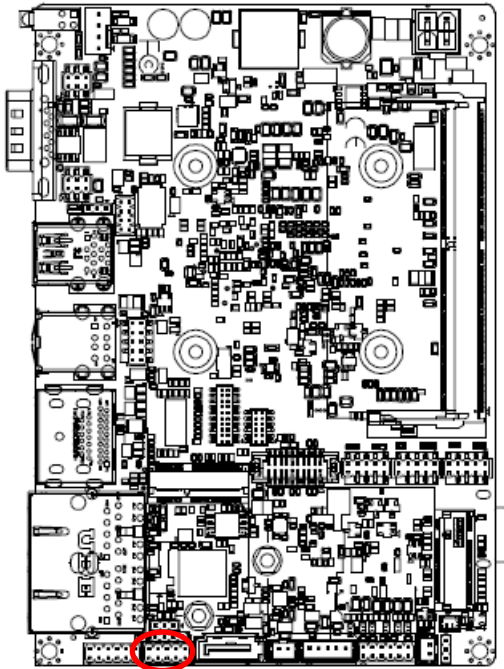

Signal	PIN	PIN	Signal
FP_HDD_LED+	1	2	FP_PWR_LED+
HDD_LED#	3	4	PWR_LED#
PMC_RSTBTN#	5	6	PWR_BTN_IN_EC#
GND	7	8	GND
NC	9		

2.4.18 PC Buzzer connector (JBZ1)

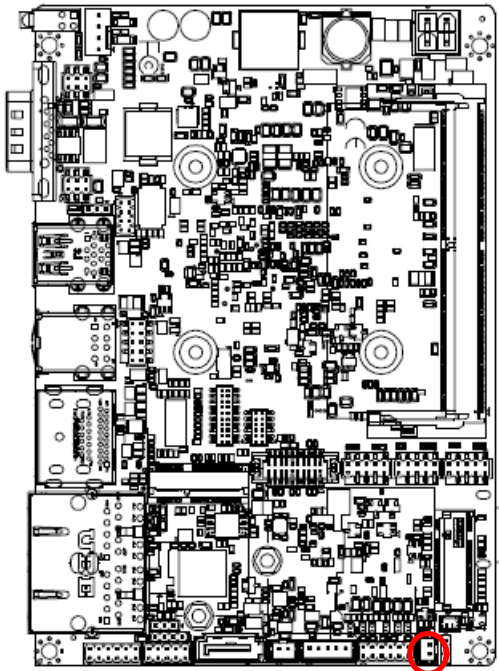

Signal	PIN
SOC_SPKR_R	1
+5V	2

2.4.19 Cortex Debug + ETM connector (JPSE1)

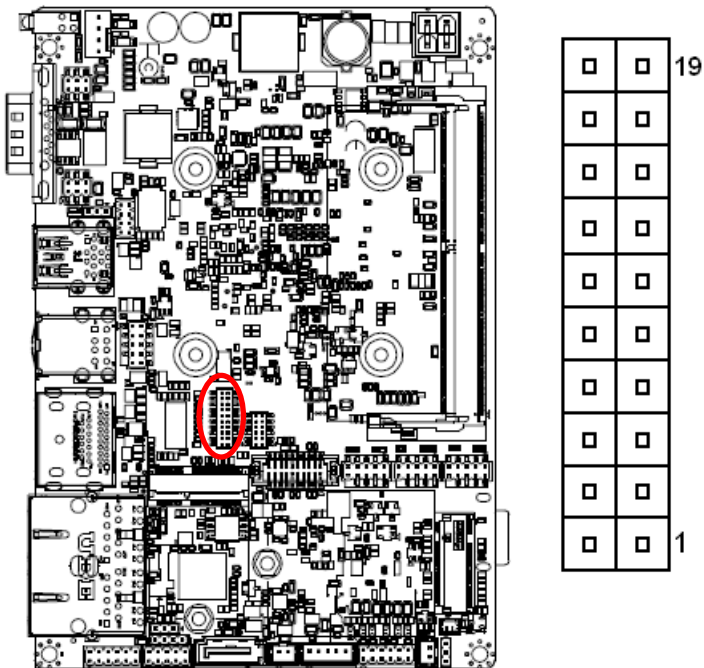

Signal	PIN	PIN	Signal
GND	20	19	PSE_TRACEDATA_3
GND	18	17	PSE_TRACEDATA_2
GND	16	15	PSE_TRACEDATA_1
TGTPWR_GND	14	13	PSE_TRACEDATA_0
TGTPWR_GND	12	11	PSE_TRACECLK
PSE_JTAG_GND_DET	10	9	PSE_JTAG_NRESET
NC	8	7	TP_TDI_PIN8
GND	6	5	PSE_TRACESWO
GND	4	3	PSE_SWCLK
+1.8VSB	2	1	PSE_SWDIO

2.4.20 Port80 connector (JESPI1)

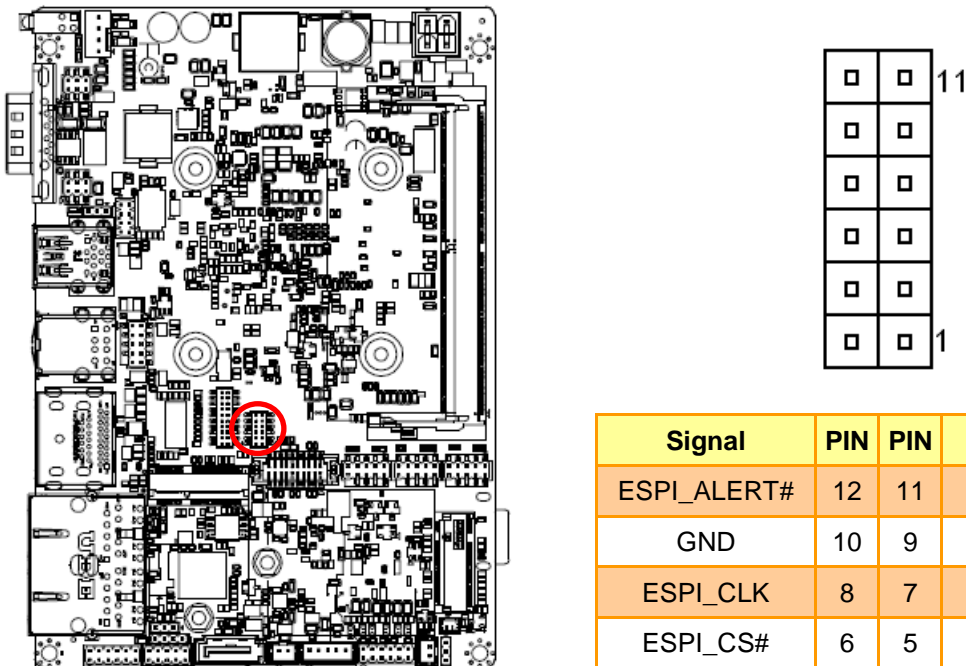

Signal	PIN	PIN	Signal
ESPI_ALERT#	12	11	ESPI_RST
GND	10	9	NC
ESPI_CLK	8	7	ESPI_IO3
ESPI_CS#	6	5	ESPI_IO2
PLT_RST_BUF#	4	3	ESPI_IO1
+3.3VSB	2	1	ESPI_IO0

2.4.21 eDP connector (JEDP1)

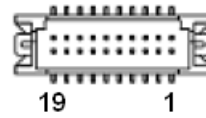
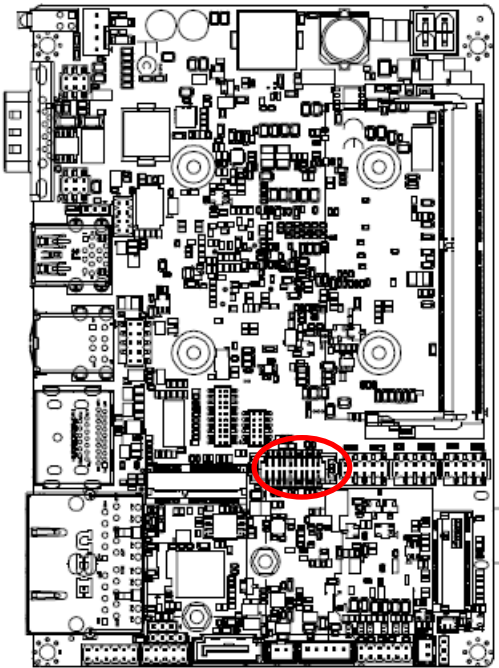

Signal	PIN	PIN	Signal
GND	1	2	GND
EDP_Panel_TXN0	3	4	EDP_Panel_TXN3
EDP_Panel_TXP0	5	6	EDP_Panel_TXP3
GND	7	8	NC
EDP_Panel_TXN1	9	10	GND
EDP_Panel_TXP1	11	12	EDP_Panel_AUXN
GND	13	14	EDP_Panel_AUXP
EDP_Panel_TXN2	15	16	GND
EDP_Panel_TXP2	17	18	SOC_DDI0_HPDP
+VeDP	19	20	+VeDP

2.4.22 Audio connector (JAUDIO1)

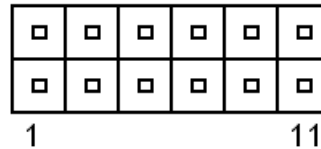
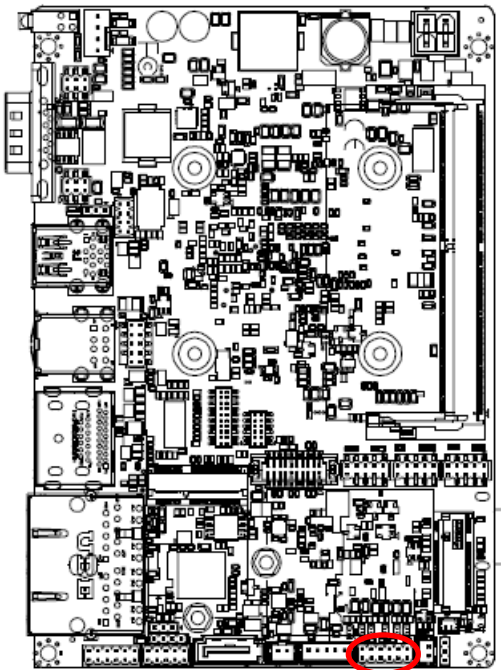

Signal	PIN	PIN	Signal
FRONT-R-OUT	1	2	FRONT-L-OUT
HD_AGND	3	4	HD_AGND
LINE1-R-IN	5	6	LINE1-L-IN
MIC1-R-IN	7	8	MIC1-L-IN
FRONT-JD	9	10	LINE1-JD
MIC1-JD	11	12	HD_AGND

2.4.22.1 Signal Description – Audio connector (JAUDIO1)

Signal	Signal Description
LINE1-JD	AUDIO IN (LINE_RIN/LIN)sense pin
FRONT-JD	AUDIO Out(ROUT/LOUT) sense pin
MIC1-JD	MIC IN (MIC_RIN/LIN) sense pin

2.5 Installing Hard Disk & Memory (EPC-EHL)

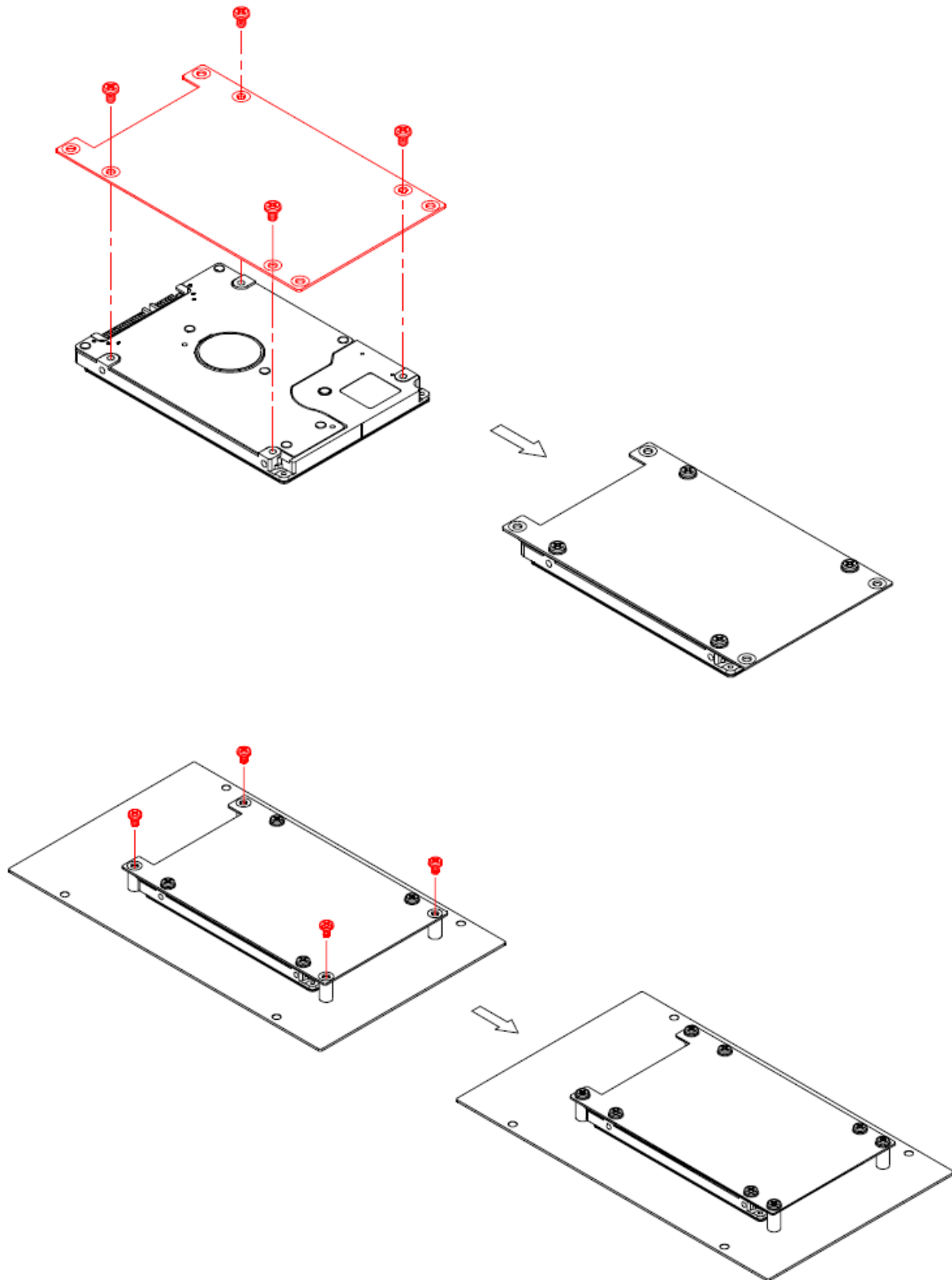

Step1. Remove screws from the bottom of your system and take it off.

Step2. Fix HDD using the 4 screws in the Accessory Kit.

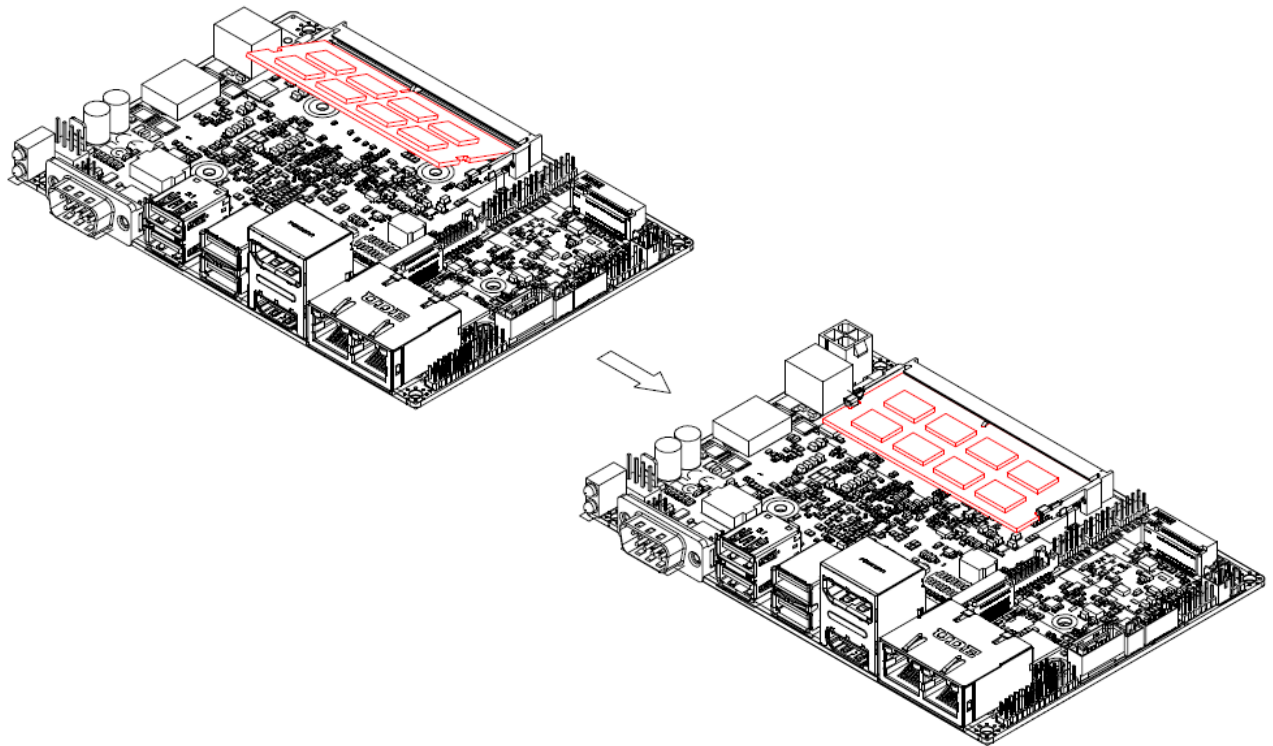

Step3. Properly install the memory modules and press until properly seated.

2.6 Installing M.2 B-Key/M.2 E-Key card (EPC-EHL)

M.2 E-Key card

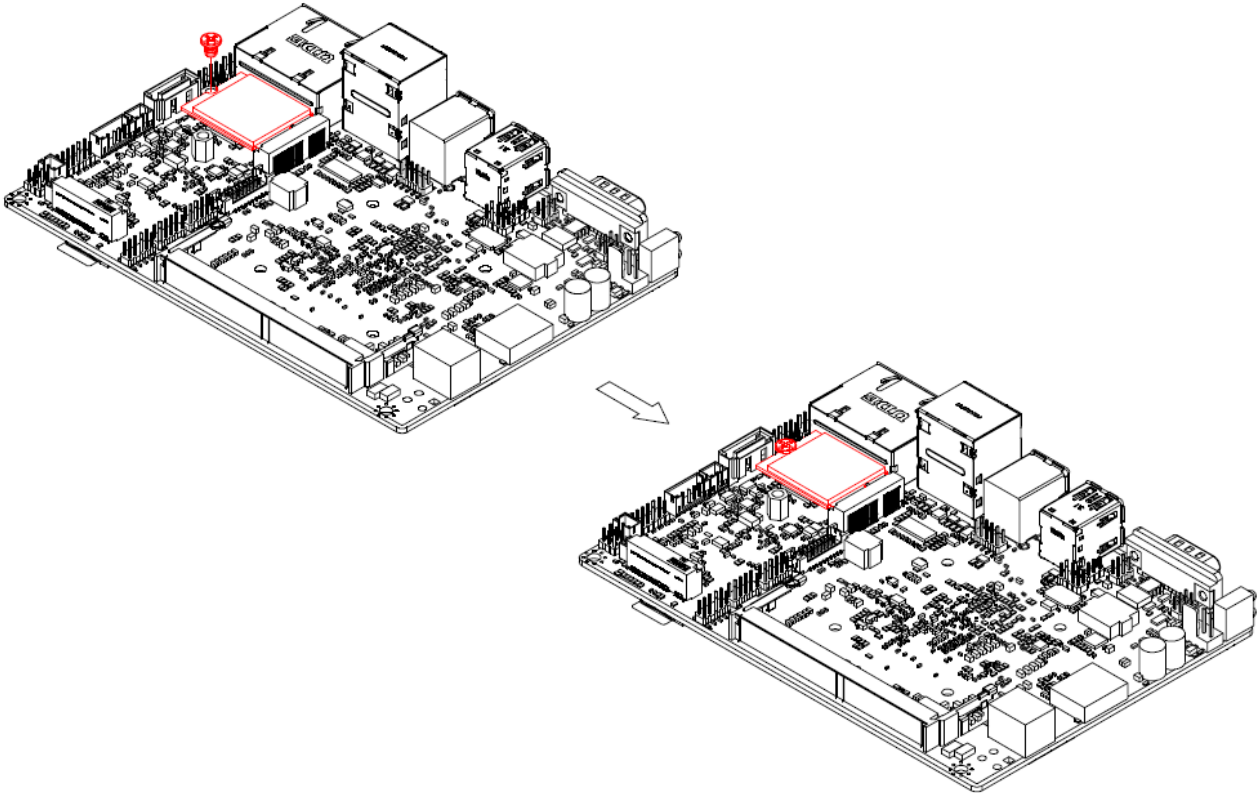

M.2 B-Key card

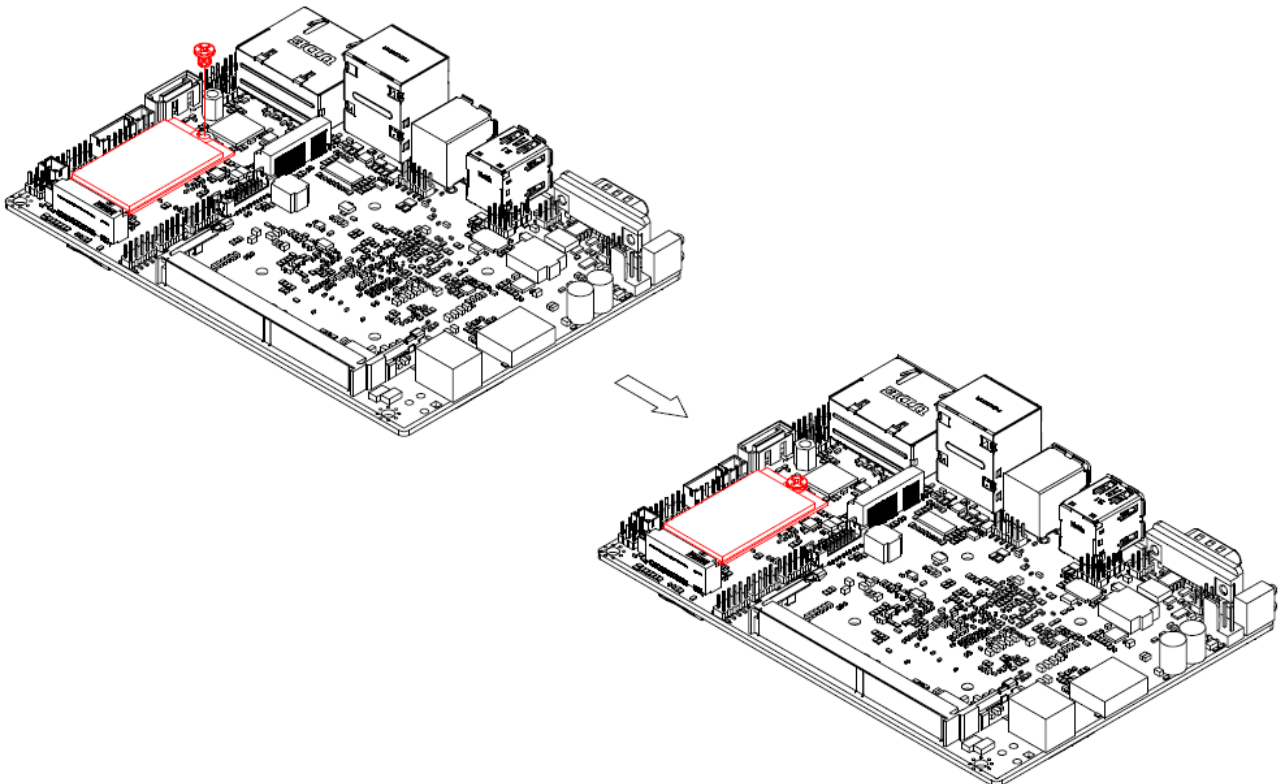

Step1. Insert M.2 B-Key/M.2 E-Key card into designated locations and fasten with the screws to complete installation.

2.7 Installing Mounting Brackets (EPC-EHL)

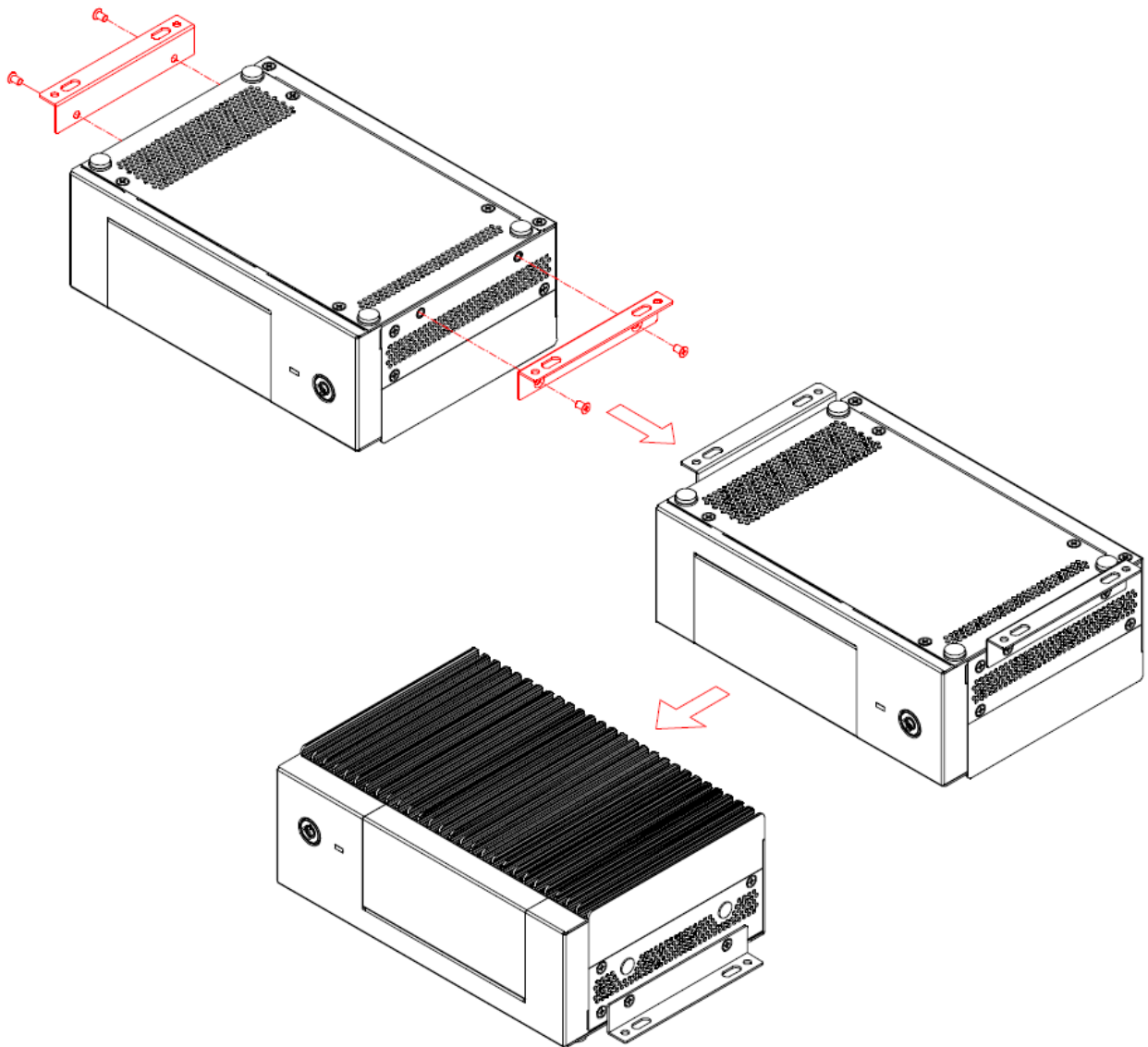

Step1. Insert and fasten 4 screws on each side of the system to secure Mounting brackets.

3. BIOS Setup

3.1 Introduction

The BIOS setup program allows users to modify the basic system configuration. In this following chapter will describe how to access the BIOS setup program and the configuration options that may be changed.

3.2 Starting Setup

AMI BIOS™ is immediately activated when you first power on the computer. The BIOS reads the system information contained in the NVRAM and begins the process of checking out the system and configuring it. When it finishes, the BIOS will seek an operating system on one of the disks and then launch and turn control over to the operating system.

While the BIOS is in control, the Setup program can be activated in one of two ways:

By pressing <ESC> or immediately after switching the system on, or

By pressing the <ESC> or key when the following message appears briefly at the left-top of the screen during the POST (Power On Self Test).

Press <ESC> or to enter SETUP

If the message disappears before you respond and you still wish to enter Setup, restart the system to try again by turning it OFF then ON or pressing the "RESET" button on the system case. You may also restart by simultaneously pressing <Ctrl>, <Alt>, and <Delete> keys.

3.3 Using Setup

In general, you use the arrow keys to highlight items, press <Enter> to select, use the PageUp and PageDown keys to change entries, press <F1> for help and press <Esc> to quit. The following table provides more detail about how to navigate in the Setup program using the keyboard.

Button	Description
↑	Move to previous item
↓	Move to next item
←	Move to the item in the left hand
→	Move to the item in the right hand
Esc key	Main Menu -- Quit and not save changes into NVRAM Status Page Setup Menu and Option Page Setup Menu -- Exit current page and return to Main Menu
+ key	Increase the numeric value or make changes
- key	Decrease the numeric value or make changes
F1 key	General help, only for Status Page Setup Menu and Option Page Setup Menu
F2 key	Previous Values
F3 key	Optimized defaults
F4 key	Save & Exit Setup

- **Navigating Through The Menu Bar**

Use the left and right arrow keys to choose the menu you want to be in.



Note: Some of the navigation keys differ from one screen to another.

- **To Display a Sub Menu**

Use the arrow keys to move the cursor to the sub menu you want. Then press <Enter>. A “➤” pointer marks all sub menus.

3.4 Getting Help

Press F1 to pop up a small help window that describes the appropriate keys to use and the possible selections for the highlighted item. To exit the Help Window press <Esc> or the <Enter> key again.

3.5 In Case of Problems

If, after making and saving system changes with Setup, you discover that your computer no longer is able to boot, the AMI BIOS supports an override to the NVRAM settings which resets your system to its defaults.

The best advice is to only alter settings which you thoroughly understand. To this end, we strongly recommend that you avoid making any changes to the chipset defaults. These defaults have been carefully chosen by both BIOS Vendor and your systems manufacturer to provide the absolute maximum performance and reliability. Even a seemingly small change to the chipset setup has the potential for causing you to use the override.

3.6 BIOS setup

Once you enter the Aptio Setup Utility, the Main Menu will appear on the screen. The Main Menu allows you to select from several setup functions and exit choices. Use the arrow keys to select among the items and press <Enter> to accept and enter the sub-menu.

3.6.1 Main Menu

This section allows you to record some basic hardware configurations in your computer and set the system clock.

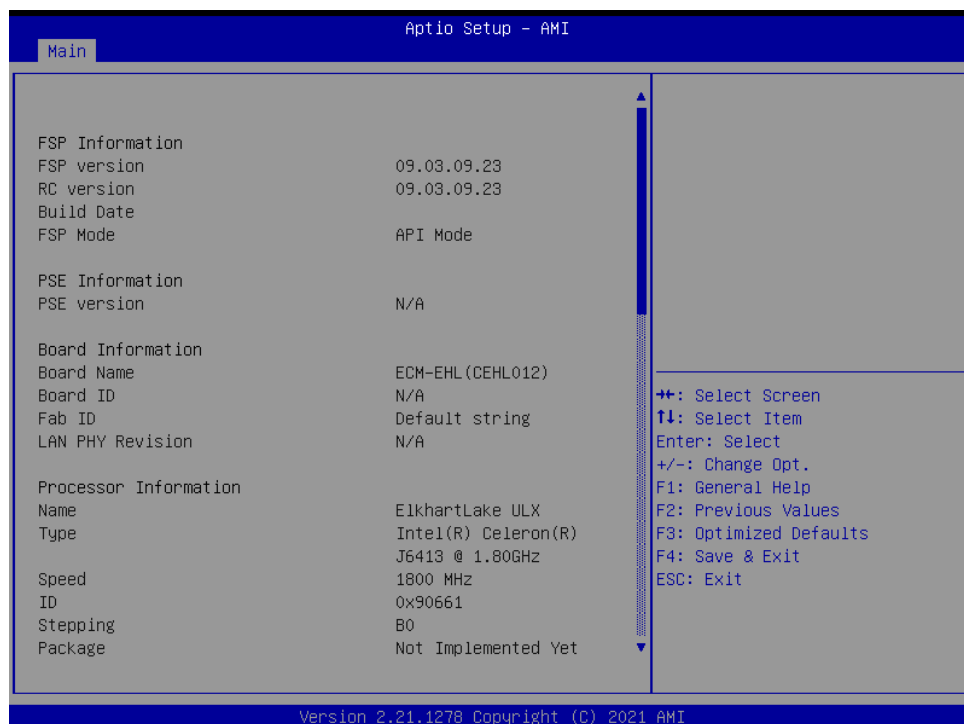
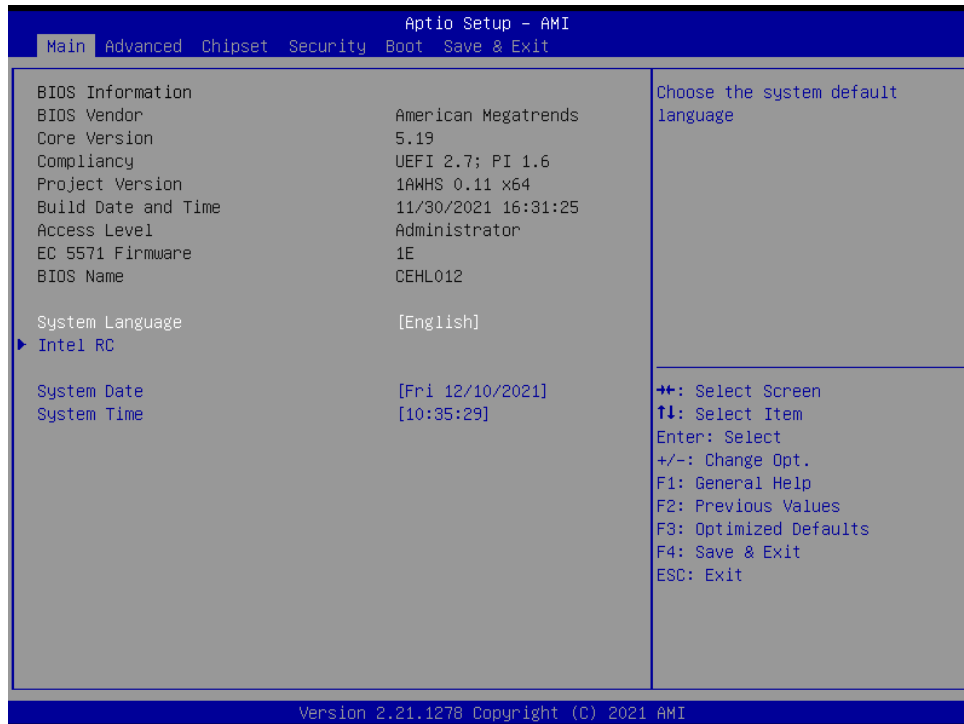

EPC-EHL

3.6.1.1 System Language

This option allows choosing the system default language.

3.6.1.2 System Date

Use the system date option to set the system date. Manually enter the day, month and year.

3.6.1.3 System Time

Use the system time option to set the system time. Manually enter the hours, minutes and seconds.



Note: The BIOS setup screens shown in this chapter are for reference purposes only, and may not exactly match what you see on your screen.

Visit the Avalue website (www.avalue.com.tw) to download the latest product and BIOS information.

3.6.2 Advanced Menu

This section allows you to configure your CPU and other system devices for basic operation through the following sub-menus.

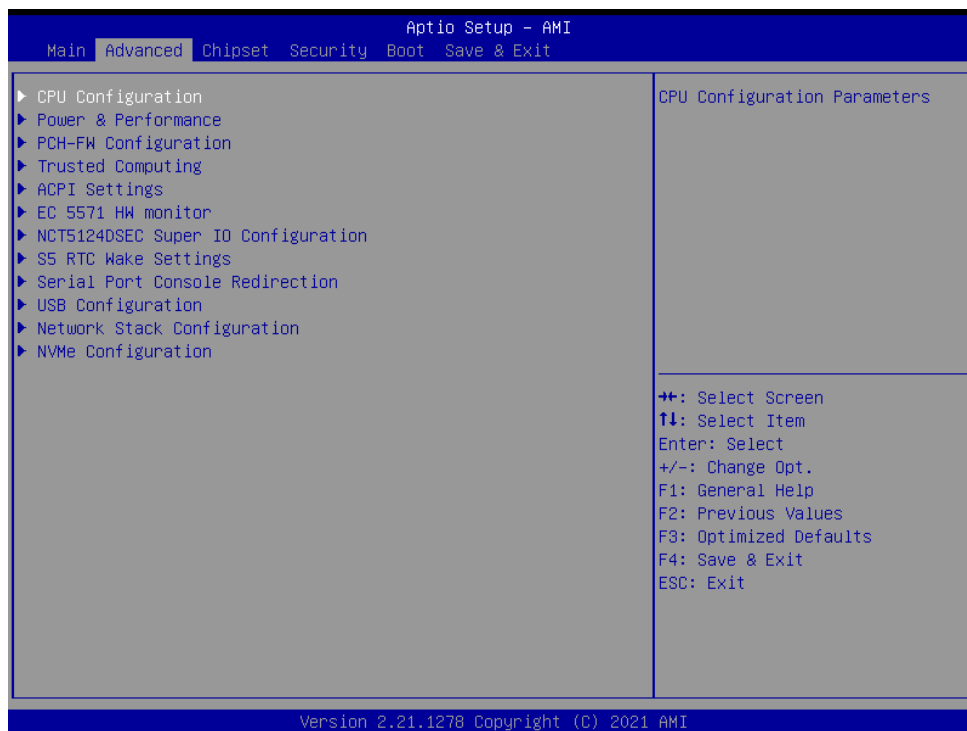

3.6.2.1 CPU Configuration

Use the CPU configuration menu to view detailed CPU specification and configure the CPU.

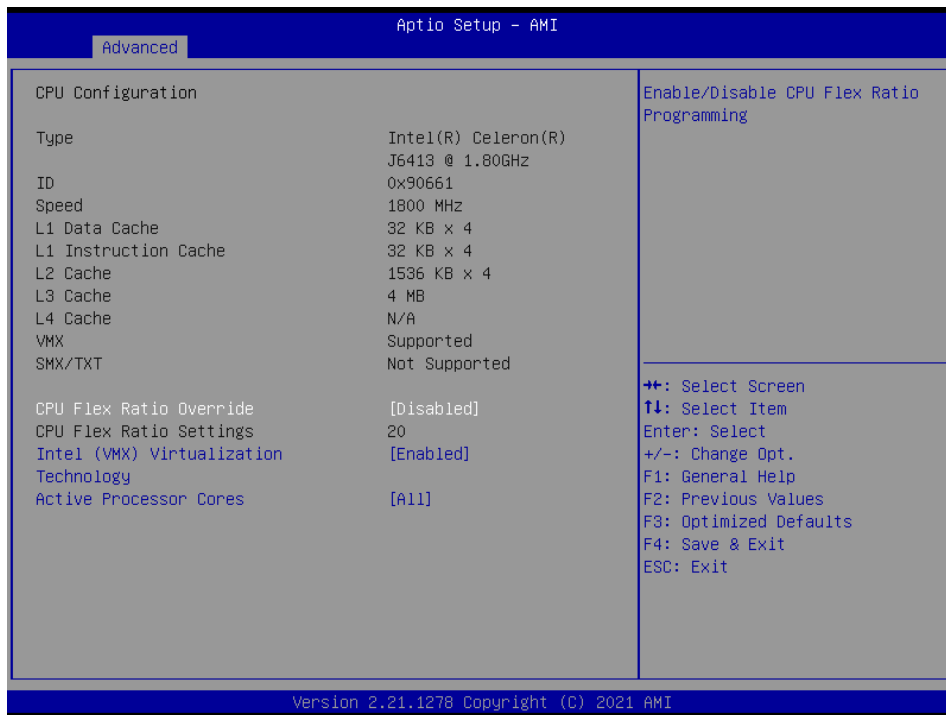

Item	Options	Description
CPU Flex Ratio Override	Disabled[Default] Enabled	Enable/Disable CPU Flex Ratio Programming.
Intel (VMX) Virtualization Technology	Disabled Enabled[Default]	When enabled, a VMM can utilize the additional hardware capabilities provided by Vanderpool Technology.
Active Processor Cores	All[Default] 1 2 3 4 5 6 7 8	Number of cores to enable in each processor package.

3.6.2.2 Power & Performance



3.6.2.2.1 CPU – Power Management Control

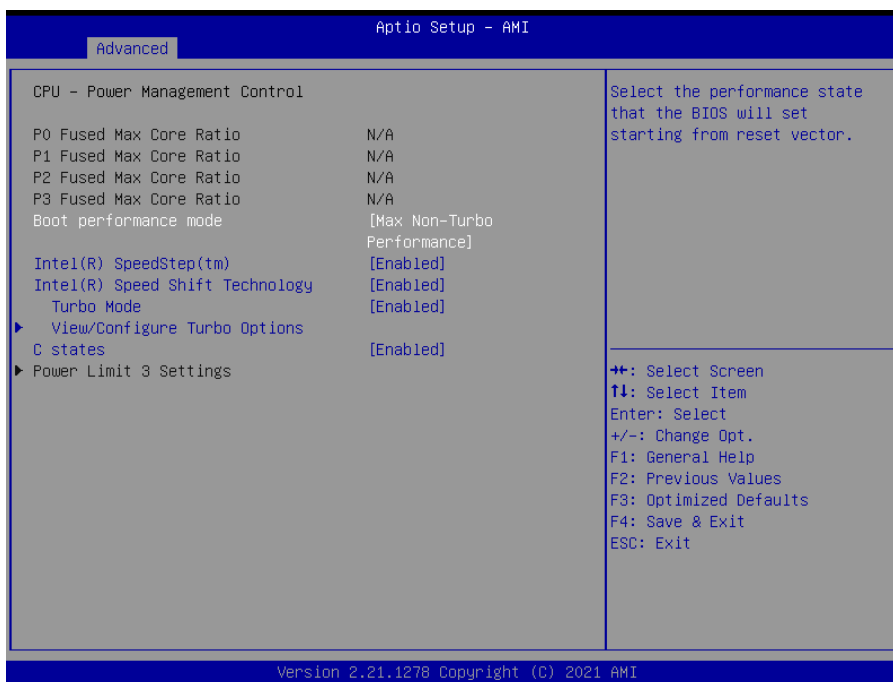

Item	Option	Description
Boot performance mode	Max Battery Max Non-Turbo Performance [Default] , Turbo Performance	Select the performance state that the BIOS will set starting from reset vector.
Intel® SpeedStep™	Enabled [Default] , Disabled	Allows more than two frequency ranges to be supported.

Intel® Speed Shift Technology	Enabled[Default], Disabled	Enable/Disable Intel® Speed Shift Technology support. Enabling will expose the CPPC v2 interface to allow for hardware controlled P-states.
Turbo Mode	Enabled[Default], Disabled	Enable/Disable processor Turbo Mode (requires Intel Speed Step or Intel Speed Shift to be available and enabled).
C States	Enabled[Default], Disabled	Enable/Disable CPU Power Management. Allows CPU to go to C states when it's not 100% utilized.

3.6.2.2.1.1 View/Configure Turbo Options

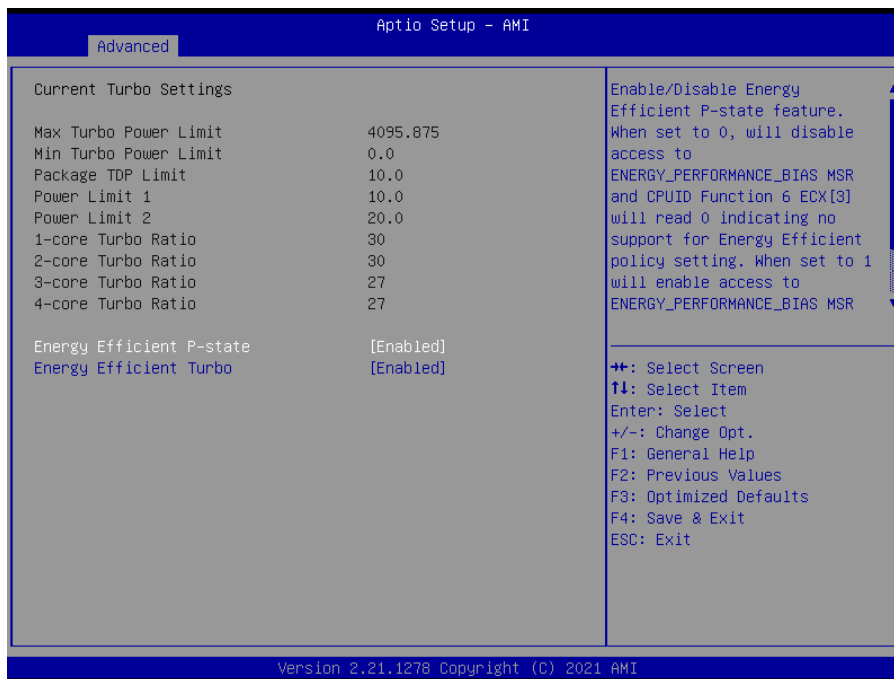

Item	Option	Description
Energy Efficient P-state	Disabled Enabled[Default]	Enable/Disable Energy Efficient P-state feature. When set to 0, will disable access to ENERGY_PERFORMANCE_BIAS MSR and CPUID Function 6 ECX[3] will read 0 indicating no support for Energy Efficient policy setting. When set to 1 will enable access to ENERGY_PERFORMANCE_BIAS MSR 1B0h.
Energy Efficient Turbo	Disabled Enabled[Default]	Enable/Disable Energy Efficient Turbo Feature. This feature will opportunistically lower the turbo frequency to increase efficiency. Recommended only to disable in overclocking situations where turbo frequency must remain constant. Otherwise, leave enabled.

3.6.2.2.2 GT – Power Management Control

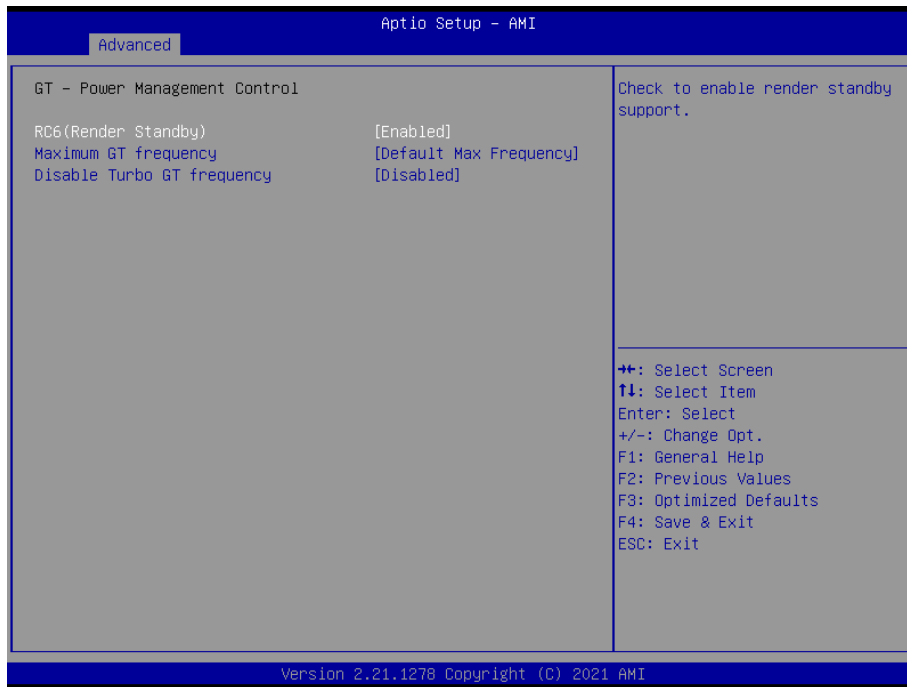

Item	Option	Description
RC6(Render Standby)	Enabled[Default], Disabled	Check to enable render standby support.
Maximum GT frequency	Default Max Frequency[Default] 100Mhz/150Mhz/200Mhz/250Mhz/300Mhz /350Mhz/400Mhz/450Mhz/500Mhz/550Mhz /600Mhz/650Mhz/700Mhz/750Mhz/800Mhz /850Mhz/900Mhz/950Mhz/1000Mhz/1050Mhz /1100Mhz/1150Mhz/1200Mhz	Auto Updated.
Disable Turbo GT frequency	Enabled Disabled[Default]	Enabled: Disables Turbo GT frequency. Disabled: GT frequency is not limited.

3.6.2.3 PCH-FW Configuration

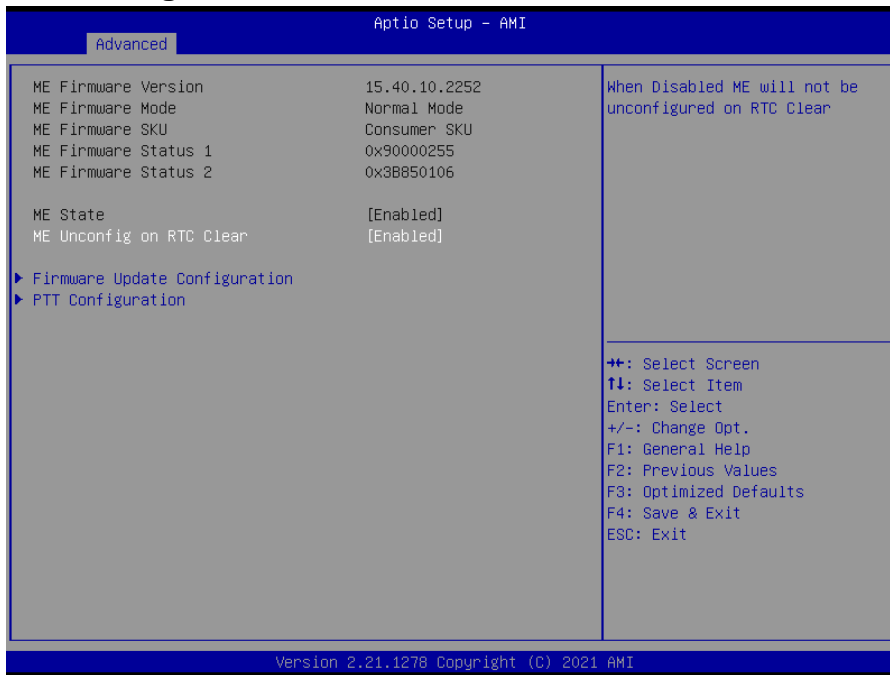

Item	Options	Description
ME Unconfig on RTC Clear	Disabled, Enabled[Default]	When Disabled ME will not be unconfigured on RTC Clear.

3.6.2.3.1 Firmware Update Configuration



Item	Option	Description
ME FW Image Re-Flash	Disabled [Default], Enabled	Enable/Disable Me FW Image Re-Flash function.

3.6.2.3.2 PTT Configuration

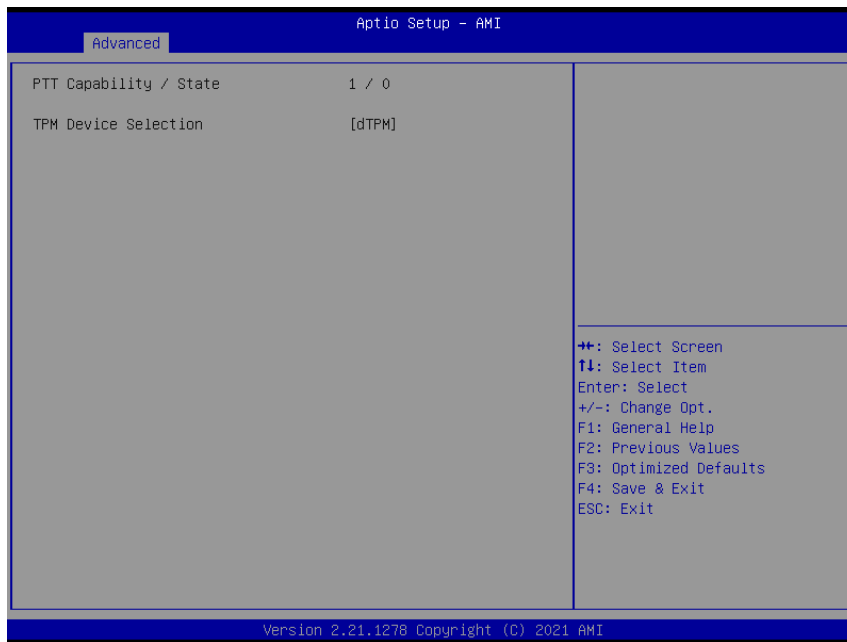

3.6.2.4 Trusted Computing

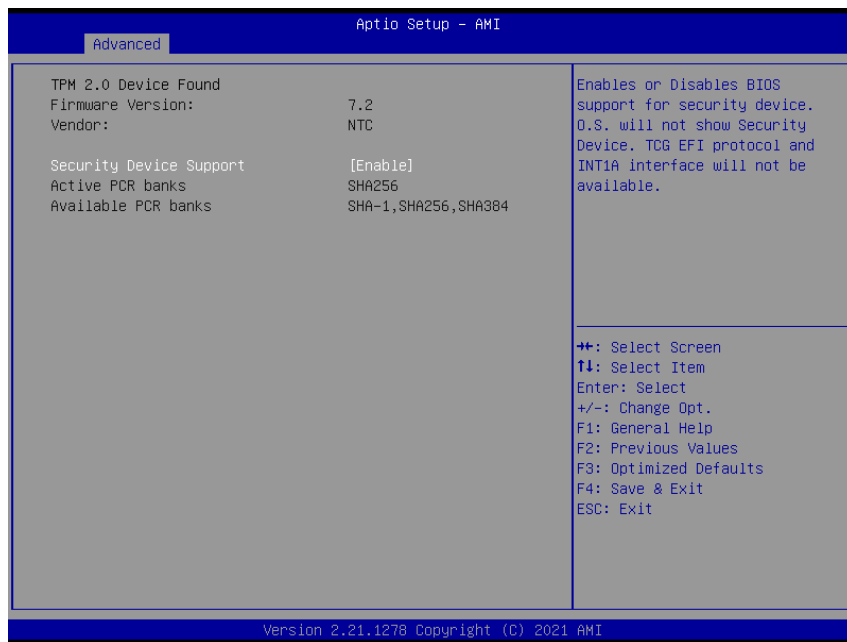

Item	Options	Description
Security Device Support	Disable, Enable[Default]	Enables or Disables BIOS support for security device. O.S. will not show Security Device. TCG EFI protocol and INT1A interface will not be available.

3.6.2.5 APCI Settings

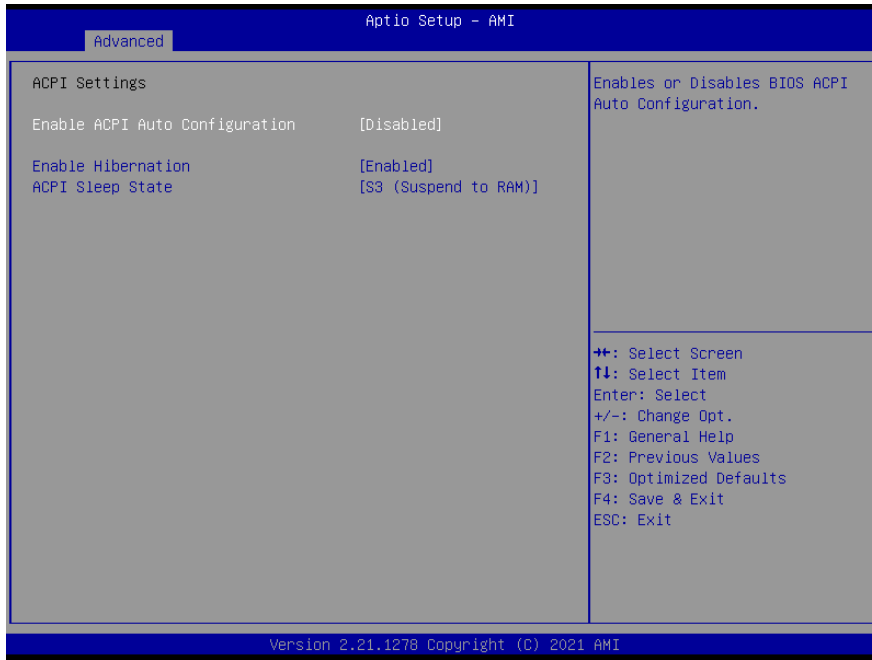

Item	Options	Description
Enable ACPI Auto Configuration	Disabled[Default], Enabled	Enables or Disables BIOS ACPI Auto Configuration.
Enable Hibernation	Disabled Enabled[Default],	Enables or Disables System ability to Hibernate (OS/S4 Sleep State). This option may not be effective with some OS.
ACPI Sleep State	Suspend Disabled, S3 (Suspend to RAM)[Default]	Select the highest ACPI sleep state the system will enter when the SUSPEND button is pressed.

3.6.2.6 HW Monitor

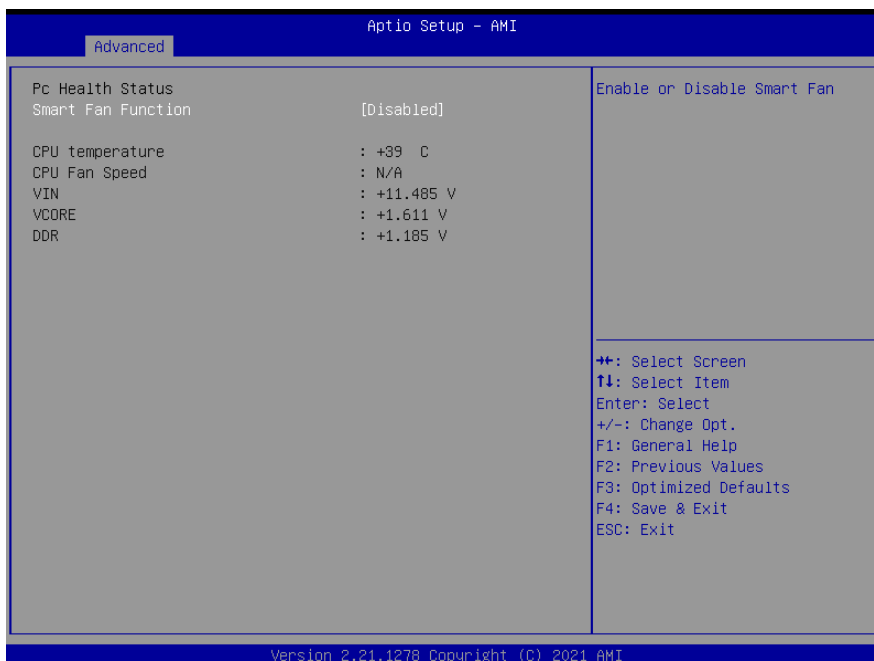

Item	Options	Description
Smart Fan Function	Enabled, Disabled[Default]	Enables or Disables Smart Fan.

3.6.2.7 NCT5124DSEC Super IO Configuration

You can use this item to set up or change the NCT5124DSEC Super IO configuration for serial ports. Please refer to 3.6.2.7.1 for more information.



Item	Description
Serial Port 1 Configuration	Set Parameters of Serial Port 1 (COMA).
Serial Port 2 Configuration	Set Parameters of Serial Port 2 (COMB).
Serial Port 3 Configuration	Set Parameters of Serial Port 3 (COMC).
Serial Port 4 Configuration	Set Parameters of Serial Port 4 (COMD).

3.6.2.7.1 Serial Port 1 Configuration

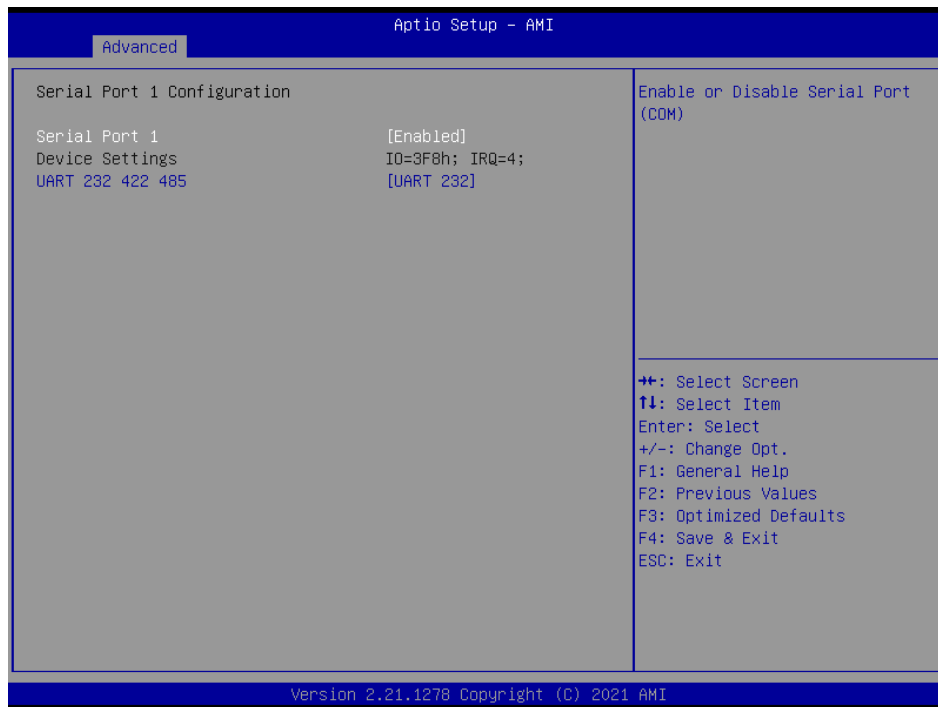

Item	Option	Description
Serial Port 1	Enabled[Default], Disabled	Enable or Disable Serial Port (COM).
UART 232 422 485	UART 232[Default], UART 422 UART 485	Change the Serial Port as RS232/422/485.

3.6.2.7.2 Serial Port 2 Configuration

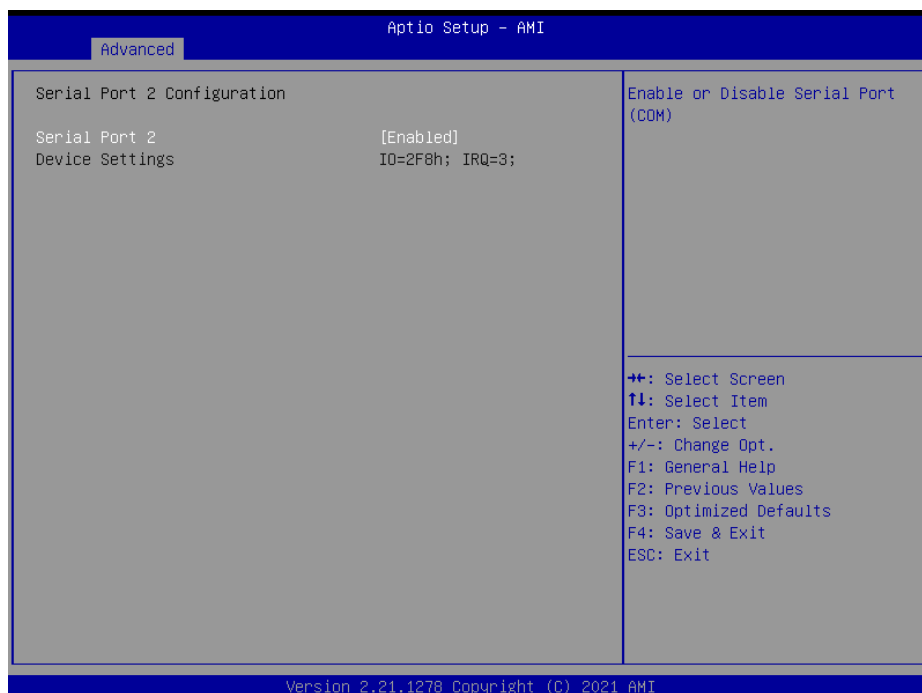

EPC-EHL

Item	Option	Description
Serial Port 2	Enabled[Default], Disabled	Enable or Disable Serial Port (COM).

3.6.2.7.3 Serial Port 3 Configuration

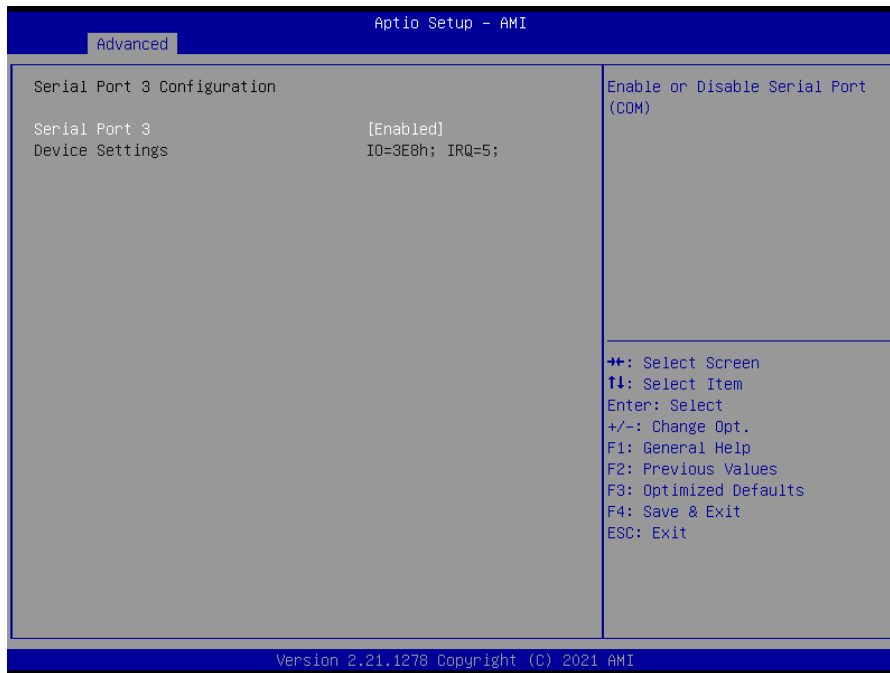

Item	Option	Description
Serial Port 3	Enabled[Default], Disabled	Enable or Disable Serial Port (COM).

3.6.2.7.4 Serial Port 4 Configuration



Item	Option	Description
Serial Port 4	Enabled[Default], Disabled	Enable or Disable Serial Port (COM).

3.6.2.8 S5 RTC Wake Settings

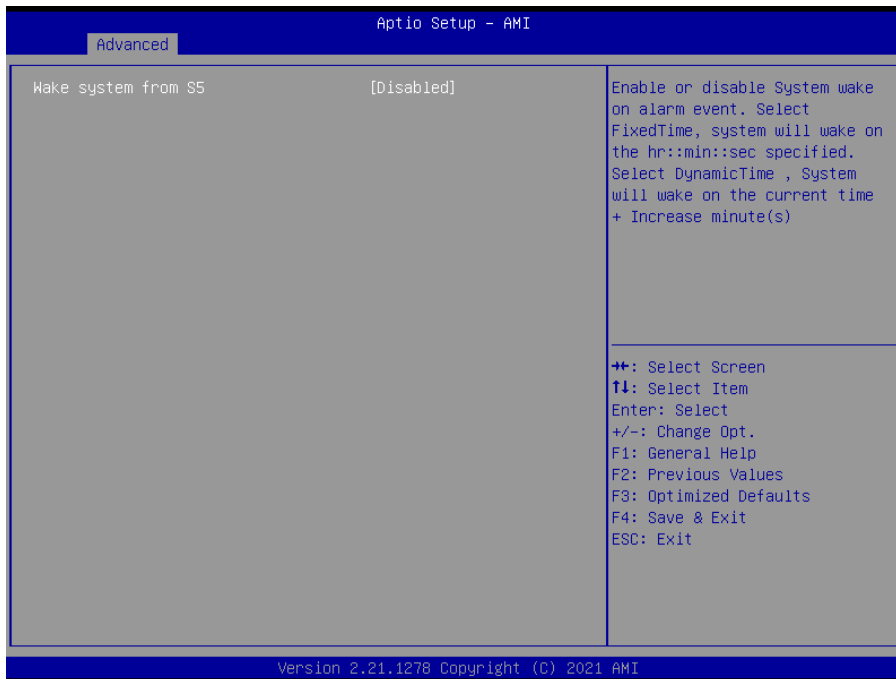

Item	Options	Description
Wake system from S5	Disabled[Default], Fixed Time Dynamic Time	Enable or disable System wake on alarm event. Select Fixed Time, system will wake on the hr::min::sec specified. Select Dynamic Time, System will wake on the current time + Increase minute(s).

3.6.2.9 Serial Port Console Redirection



Item	Options	Description
Console Redirection	Disabled[Default], Enabled	Console Redirection Enable or Disable.
Console Redirection EMS	Disabled[Default], Enabled	Console Redirection Enable or Disable.

3.6.2.10 USB Configuration

The USB Configuration menu helps read USB information and configures USB settings.

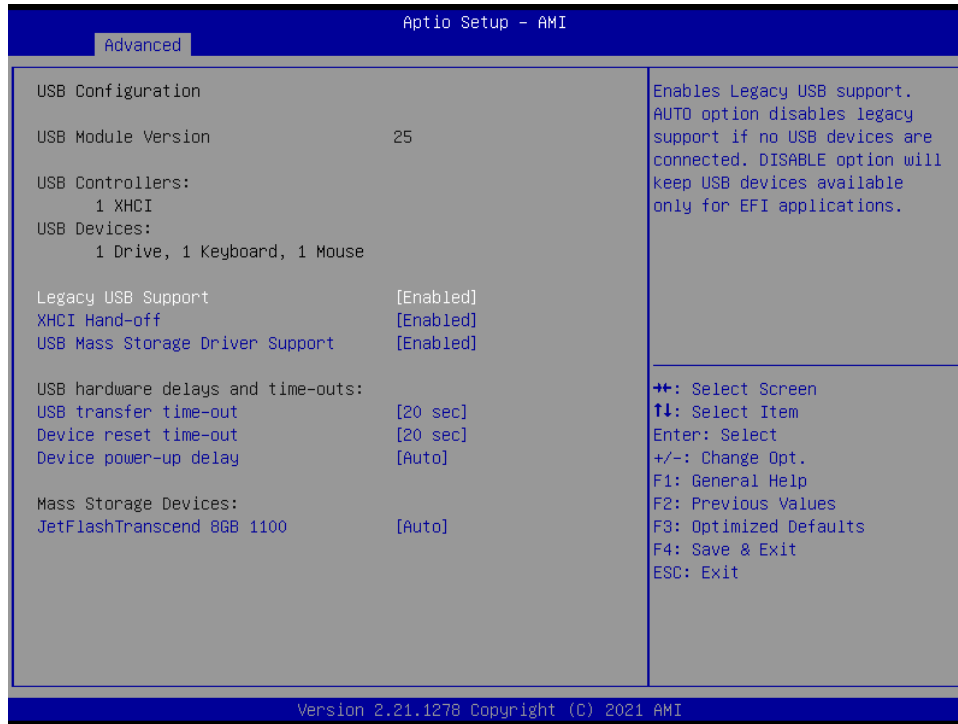

Item	Options	Description
Legacy USB Support	Enabled[Default], Disabled Auto	Enables Legacy USB support. AUTO option disables legacy support if no USB devices are connected. DISABLE option will keep USB devices available only for EFI applications.
XHCI Hand-off	Enabled[Default], Disabled	This is a workaround for OSeS without XHCI hand-off support. The XHCI ownership change should be claimed by XHCI driver.
USB Mass Storage Driver Support	Disabled Enabled[Default],	Enable/Disable USB Mass Storage Driver Support.
USB transfer time-out	1 sec 5 sec 10 sec 20 sec[Default]	The time-out value for Control, Bulk, and Interrupt transfers.
Device reset time-out	10 sec 20 sec[Default] 30 sec 40 sec	USB mass storage device Start Unit command time-out.
Device power-up delay	Auto[Default]	Maximum time the device will take before it

	Manual	properly reports itself to the Host Controller. 'Auto' uses default value: for a Root port it is 100ms, for a Hub port the delay is taken form Hub descriptor.
Mass Storage Devices	Auto[Default] Floppy Forced FDD Hard Disk CD-ROM	Mass storage device emulation type. 'AUTO' enumerates devices according to their media format. Optical drives are emulated as 'CDROM', drives with no media will be emulated according to a drive type.

3.6.2.11 Network Stack Configuration

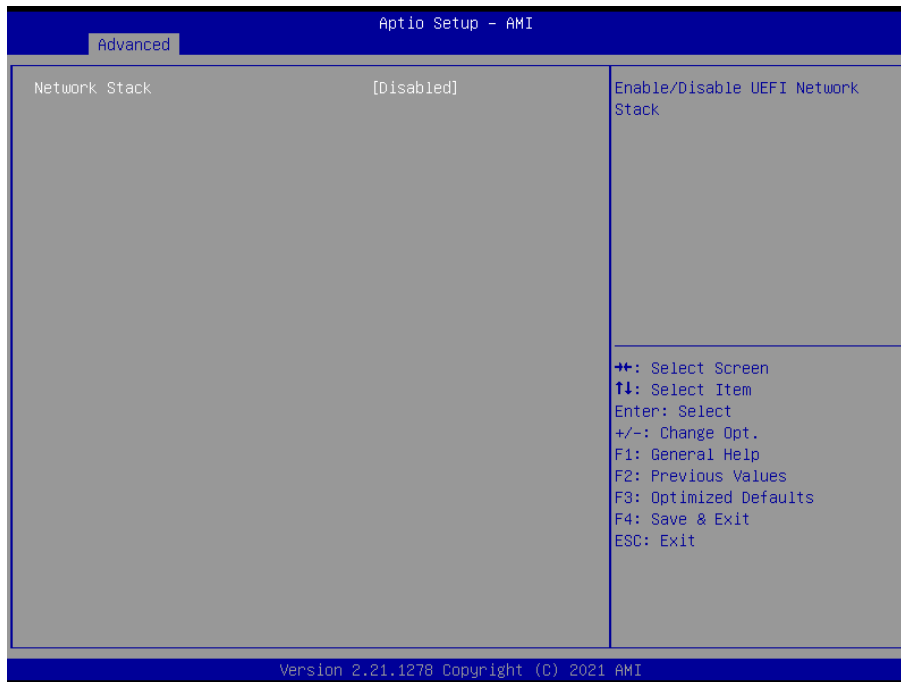

Item	Options	Description
Network Stack	Enabled Disabled[Default]	Enable/Disable UEFI Network Stack.

3.6.2.12 NVMe Configuration

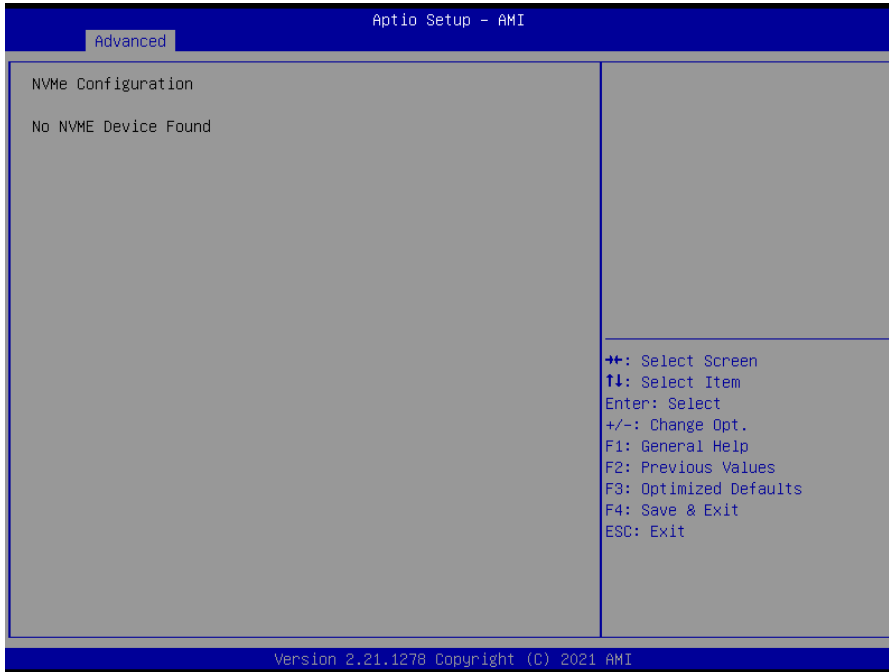

3.6.3 Chipset

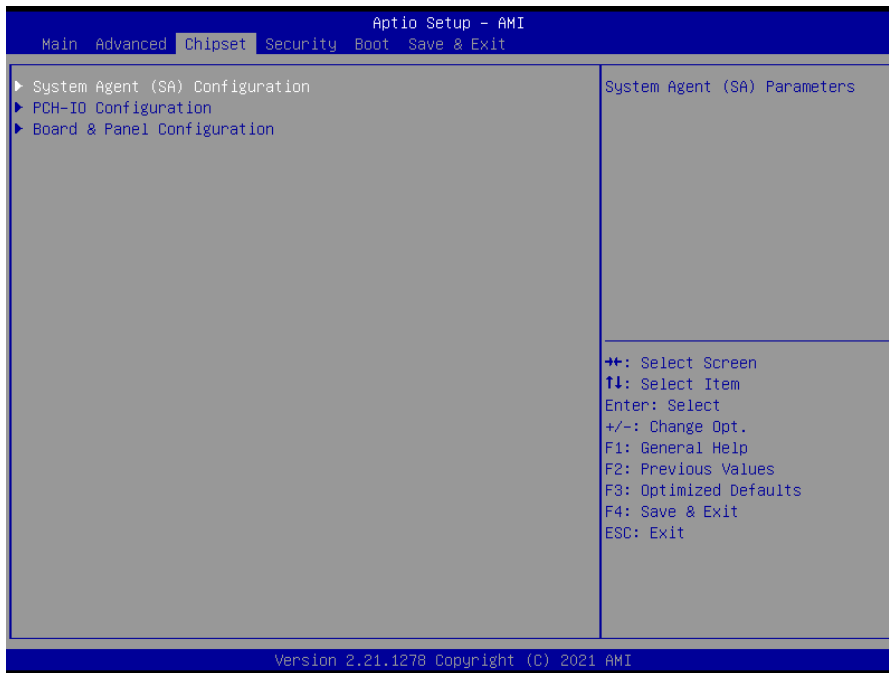

3.6.3.1 System Agent (SA) Configuration



Item	Option	Description
VT-d	Enabled[Default] Disabled	VT-d capability.
Above 4GB MMIO BIOS assignment	Enabled Disabled[Default]	Enable/Disable above 4GB MemoryMappedIO BIOS assignment. This is enabled automatically when Aperture Size is set to 2048MB.

3.6.3.1.1 Memory Configuration

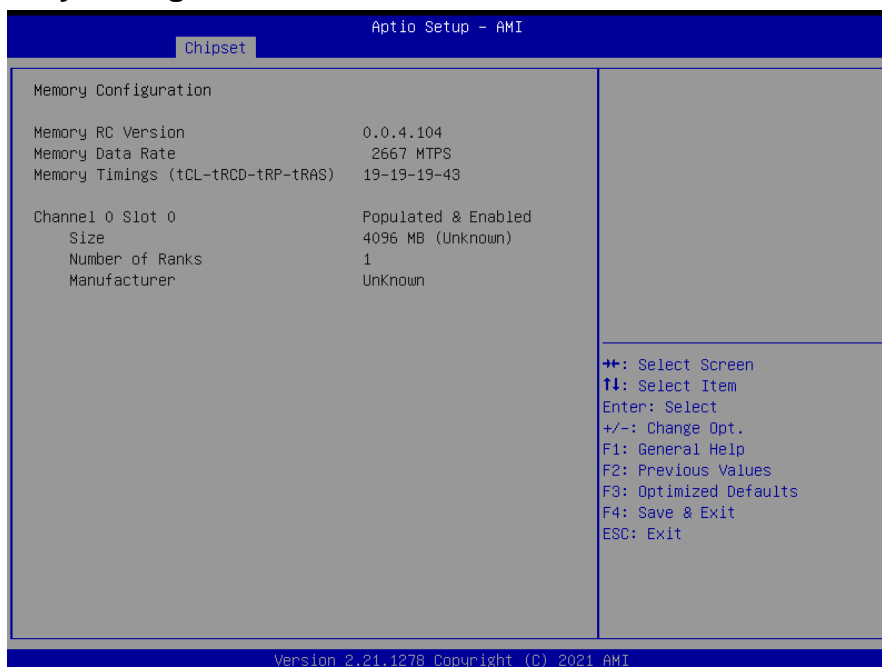

3.6.3.1.2 Graphics Configuration

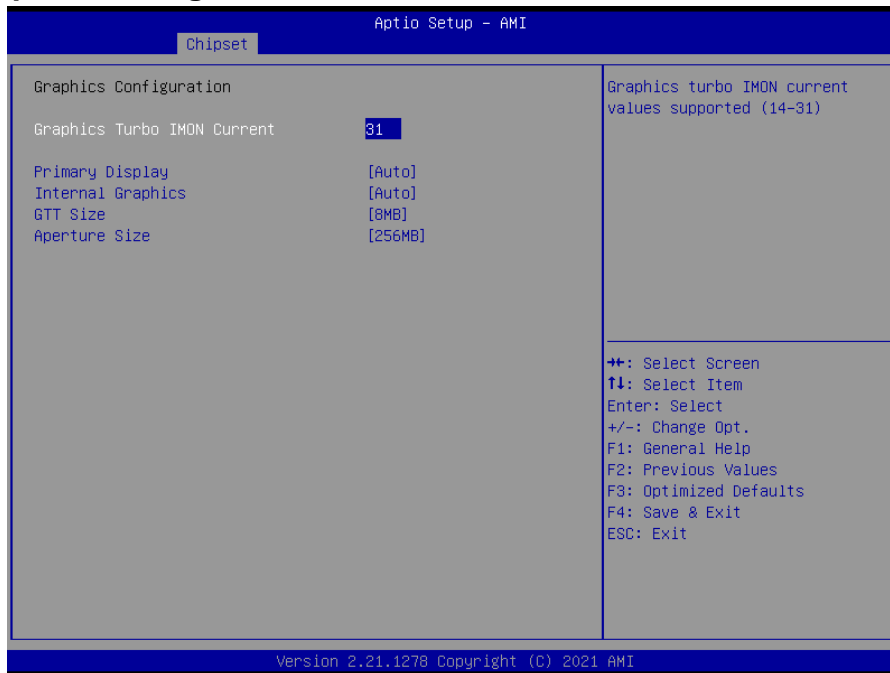

Item	Option	Description
Graphics Turbo IMON Current	14-31 [Default]	Graphics turbo IMON current values supported (14-31).
Primary Display	Auto [Default] IGFX PEG PCI	Select which of IGFX/PEG/PCI Graphics device should be Primary Display Or select SG for Switchable Gfx.
Internal Graphics	Auto [Default] Disabled Enabled	Keep IGFX enabled based on the setup options.
GTT Size	2MB 4MB 8MB [Default]	Select the GTT Size.
Aperture Size	128MB 256MB [Default] 512MB 1024MB	Select the Aperture Size. Note: Above 4GB MMIO BIOS assignment is automatically enabled when selecting 2048MB aperture. To use this feature, please disable CSM Support.

3.6.3.2 PCH-IO Configuration

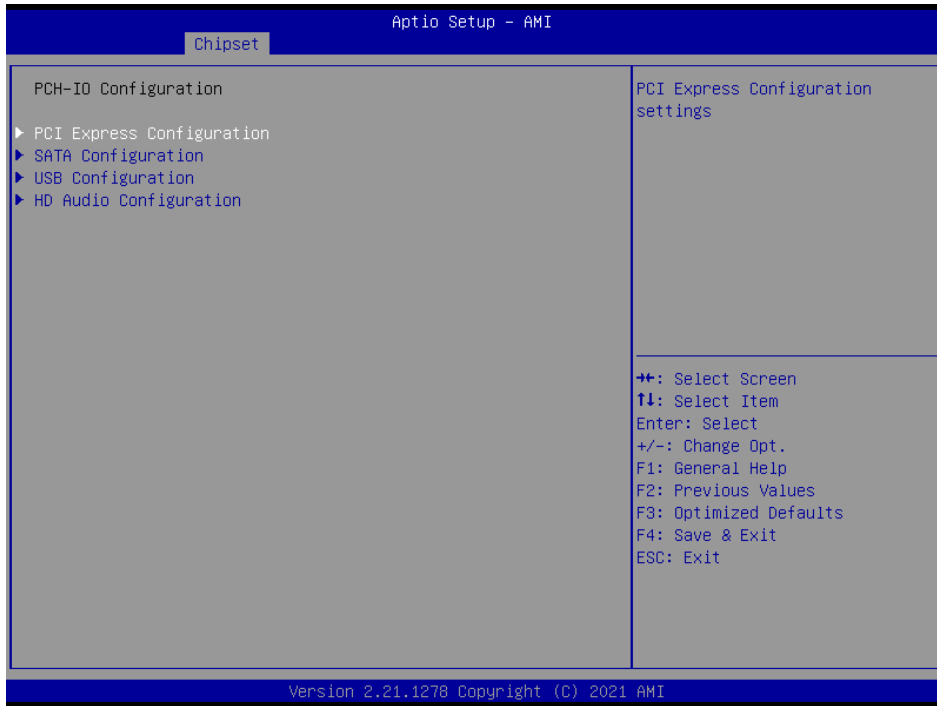

3.6.3.2.1 PCI Express Configuration

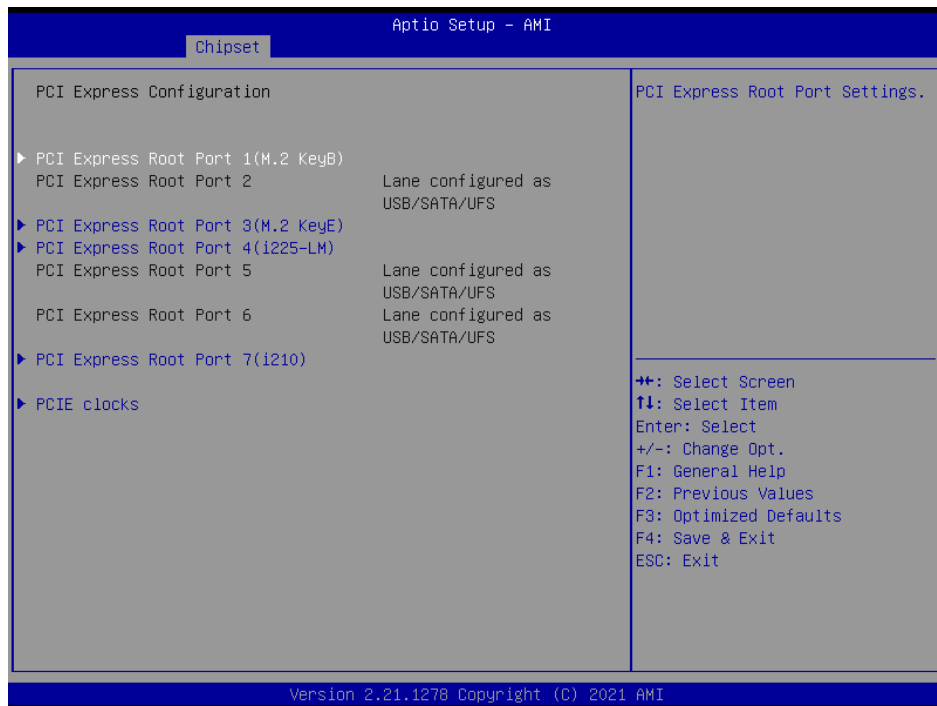

3.6.3.2.1.1 PCI Express Root Port 1(M.2 KeyB)

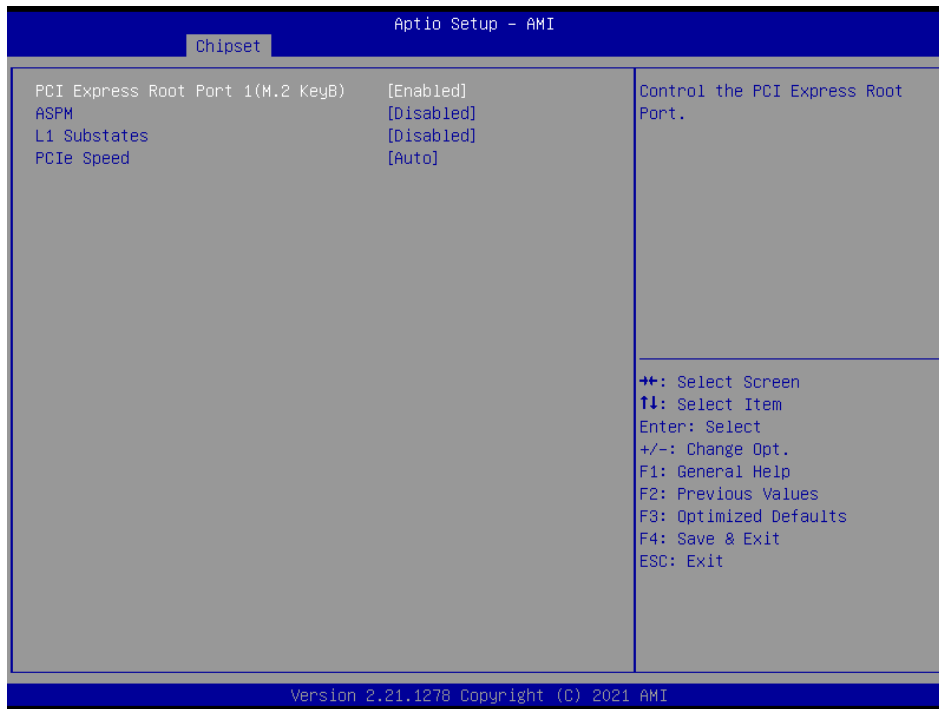

Item	Option	Description
PCI Express Root Port 1(M.2 KeyB)	Enabled[Default], Disabled	Control the PCI Express Root Port.
ASPM	Disabled[Default], L0s L1 L0sL1 Auto	Set the ASPM Level: Force L0s – Force all links to L0s State AUTO – BIOS auto configure DISABLE – Disables ASPM.
L1 Substates	Disabled[Default] L1.1 L1.1 & L1.2	PCI Express L1 Substates settings.
PCIe Speed	Auto[Default] Gen1 Gen2 Gen3	Configure PCIe Speed.

3.6.3.2.1.2 PCI Express Root Port 3(M.2 KeyE)

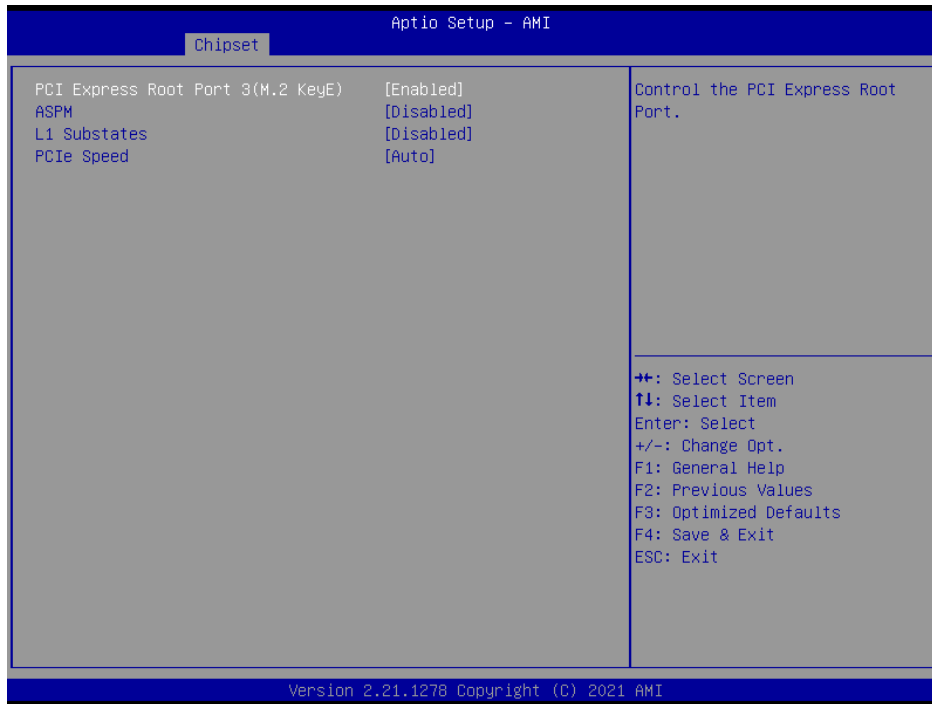

Item	Option	Description
PCI Express Root Port 3(M.2 KeyE)	Enabled[Default], Disabled	Control the PCI Express Root Port.
ASPM	Disabled[Default], L0s L1 L0sL1 Auto	Set the ASPM Level: Force L0s – Force all links to L0s State AUTO – BIOS auto configure DISABLE – Disables ASPM.
L1 Substates	Disabled[Default] L1.1 L1.1 & L1.2	PCI Express L1 Substates settings.
PCIe Speed	Auto[Default] Gen1 Gen2 Gen3	Configure PCIe Speed.

3.6.3.2.1.3 PCI Express Root Port 4(i225-LM)

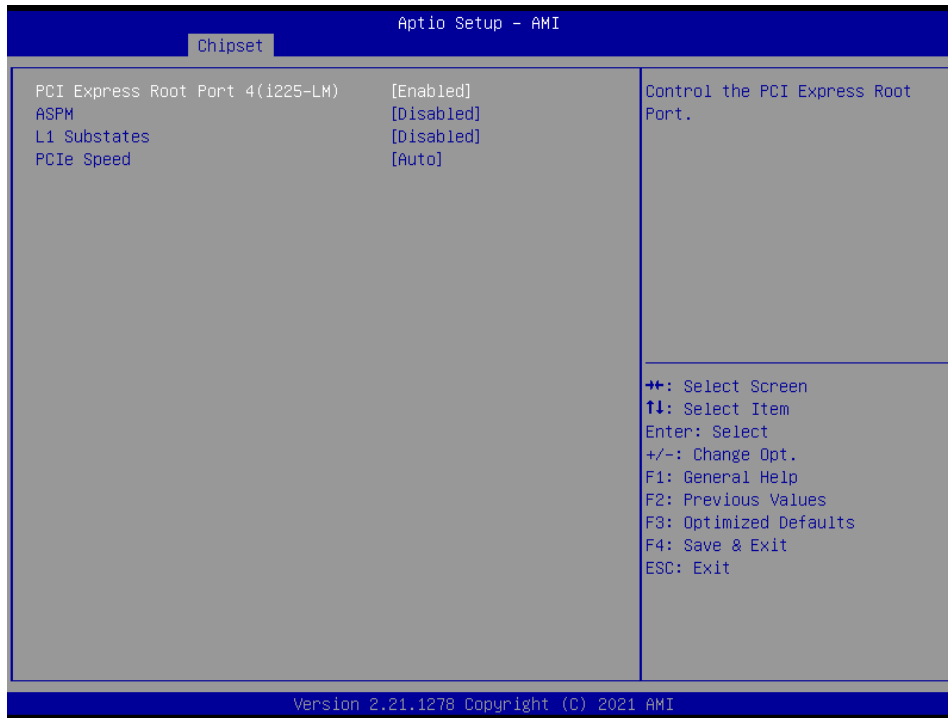

Item	Option	Description
PCI Express Root Port 4(i225-LM)	Enabled[Default], Disabled	Control the PCI Express Root Port.
ASPM	Disabled[Default], L0s L1 L0sL1 Auto	Set the ASPM Level: Force L0s – Force all links to L0s State AUTO – BIOS auto configure DISABLE – Disables ASPM.
L1 Substates	Disabled[Default], L1.1 L1.1 & L1.2	PCI Express L1 Substates settings.
PCIe Speed	Auto[Default] Gen1 Gen2 Gen3	Configure PCIe Speed.

3.6.3.2.1.4 PCI Express Root Port 7(i210)

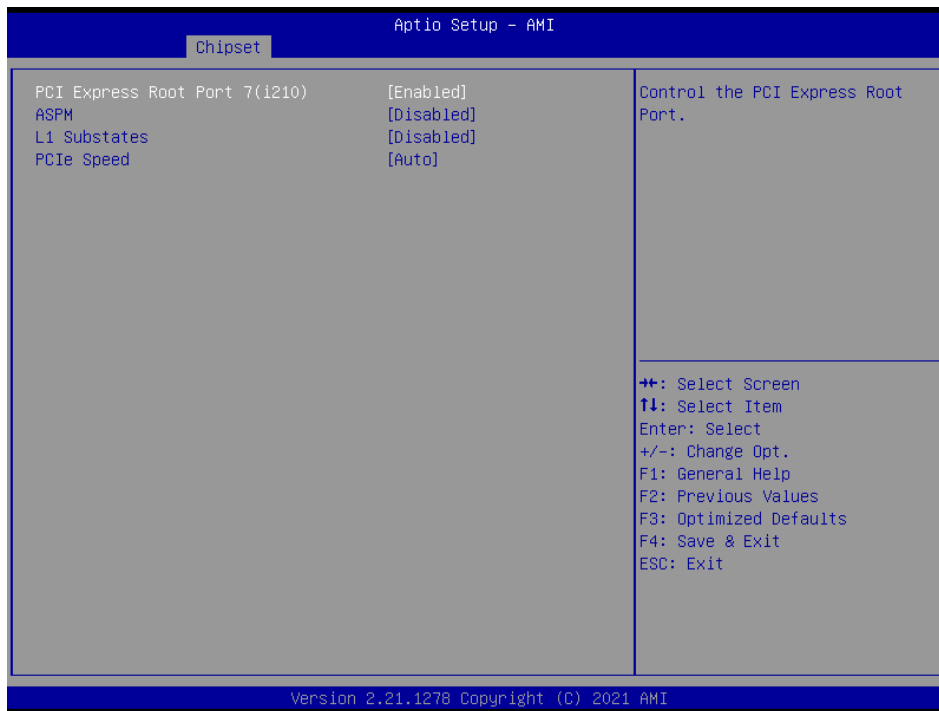

Item	Option	Description
PCI Express Root Port 7(i210)	Enabled[Default], Disabled	Control the PCI Express Root Port.
ASPM	Disabled[Default], L0s L1 L0sL1 Auto	Set the ASPM Level: Force L0s – Force all links to L0s State AUTO – BIOS auto configure DISABLE – Disables ASPM.
L1 Substates	Disabled[Default], L1.1 L1.1 & L1.2	PCI Express L1 Substates settings.
PCIe Speed	Auto[Default] Gen1 Gen2 Gen3	Configure PCIe Speed.

3.6.3.2.1.5 PCIE clocks

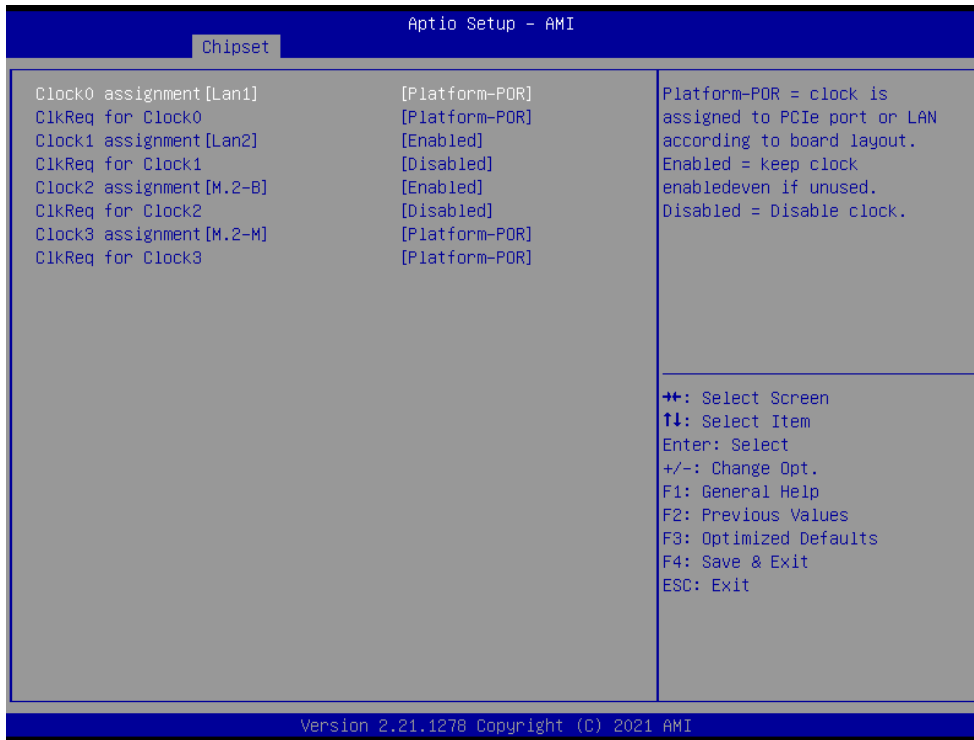

Item	Option	Description
Clock0 assignment[Lan1]	Platform-POR[Default], Enabled Disabled	Platform-POR= clock is assigned to PCIe port or LAN according to board layout. Enabled= keep clock enabled even if unused. Disabled = Disable clock.
ClkReq for Clock0	Platform-POR[Default], Disabled	Platform-POR= CLKREQ signal is assigned to CLKSRC according to board layout. Disabled = CLKREQ will not be used.
Clock1 assignment[Lan2]	Platform-POR Enabled[Default], Disabled	Platform-POR= clock is assigned to PCIe port or LAN according to board layout. Enabled= keep clock enabled even if unused. Disabled = Disable clock.
ClkReq for Clock1	Platform-POR, Disabled[Default]	Platform-POR= CLKREQ signal is assigned to CLKSRC according to board layout. Disabled = CLKREQ will not be used.
Clock2 assignment[M.2-B]	Platform-POR Enabled[Default] Disabled	Platform-POR= clock is assigned to PCIe port or LAN according to board layout. Enabled= keep clock enabled even if unused. Disabled = Disable clock.
ClkReq for Clock2	Platform-POR, Disabled[Default]	Platform-POR= CLKREQ signal is assigned to CLKSRC according to board layout. Disabled = CLKREQ will not be used.
Clock3 assignment[M.2-M]	Platform-POR[Default], Enabled Disabled	Platform-POR= clock is assigned to PCIe port or LAN according to board layout. Enabled= keep clock enabled even if unused. Disabled = Disable clock.

<p>ClkReq for Clock3</p>	<p>Platform-POR[Default], Disabled</p>	<p>Platform-POR= CLKREQ signal is assigned to CLKSRC according to board layout. Disabled = CLKREQ will not be used.</p>
---------------------------------	---	---

3.6.3.2.2 SATA Configuration

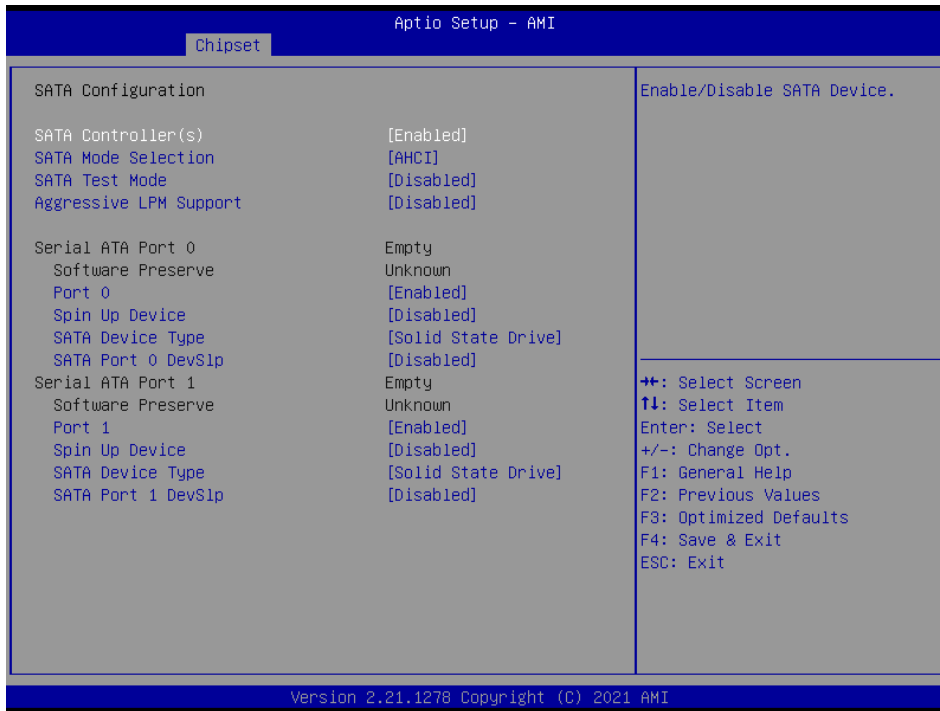

Item	Options	Description
<p>SATA Controller(s)</p>	<p>Enabled[Default] Disabled,</p>	<p>Enable/Disable SATA Device.</p>
<p>SATA Mode Selection</p>	<p>AHCI[Default],</p>	<p>Determines how SATA controller(s) operate.</p>
<p>SATA Test Mode</p>	<p>Enabled Disabled[Default]</p>	<p>Test Mode Enable/Disable (Loop Back).</p>
<p>Aggressive LPM Support</p>	<p>Enabled Disabled[Default]</p>	<p>Enable PCH to aggressively enter link power state.</p>
<p>Port 0</p>	<p>Enabled[Default] Disabled</p>	<p>Enable or Disable SATA Port.</p>
<p>Spin Up Device</p>	<p>Enabled Disabled[Default]</p>	<p>If enabled for any of ports Staggered Spin Up will be performed and only the drives which have this option enabled will spin up at boot. Otherwise all drives spin up at boot.</p>
<p>SATA Device Type</p>	<p>Hard Disk Drive Solid State Drive[Default]</p>	<p>Identify the SATA port is connected to Solid State Drive or Hard Disk Drive.</p>
<p>SATA Port 0 DevSlp</p>	<p>Disabled[Default] Enabled</p>	<p>Enable/Disable SATA Port 0 DevSlp. For DevSlp to work, both hard drive and SATA port need to support DevSlp function, otherwise an unexpected behaviour might happen. Please check board design before enabling it.</p>

EPC-EHL

Port 1	Enabled[Default] Disabled	Enable or Disable SATA Port.
Spin Up Device	Enabled Disabled[Default]	If enabled for any of ports Staggered Spin Up will be performed and only the drives which have this option enabled will spin up at boot. Otherwise all drives spin up at boot.
SATA Device Type	Hard Disk Drive Solid State Drive[Default]	Identify the SATA port is connected to Solid State Drive or Hard Disk Drive.
SATA Port 1 DevSlp	Disabled[Default] Enabled	Enable/Disable SATA Port 1 DevSlp. For DevSlp to work, both hard drive and SATA port need to support DevSlp function, otherwise an unexpected behaviour might happen. Please check board design before enabling it.

3.6.3.2.3 USB Configuration



Item	Options	Description
XHCI Compliance Mode	Disabled[Default] Enabled	Option to enable Compliance Mode. Default is to disable Compliance Mode. Change to enabled for Compliance Mode testing.
USB3 Link Speed Selection	GEN1 GEN2[Default],	This option is to select USB3 Link Speed GEN1 or GEN2.
USB Port Disable Override	Disabled[Default] Select-Per-Pin	Selectively Enable/Disable the corresponding USB port from reporting a Device Connection to the controller.

3.6.3.2.4 HD Audio Configuration

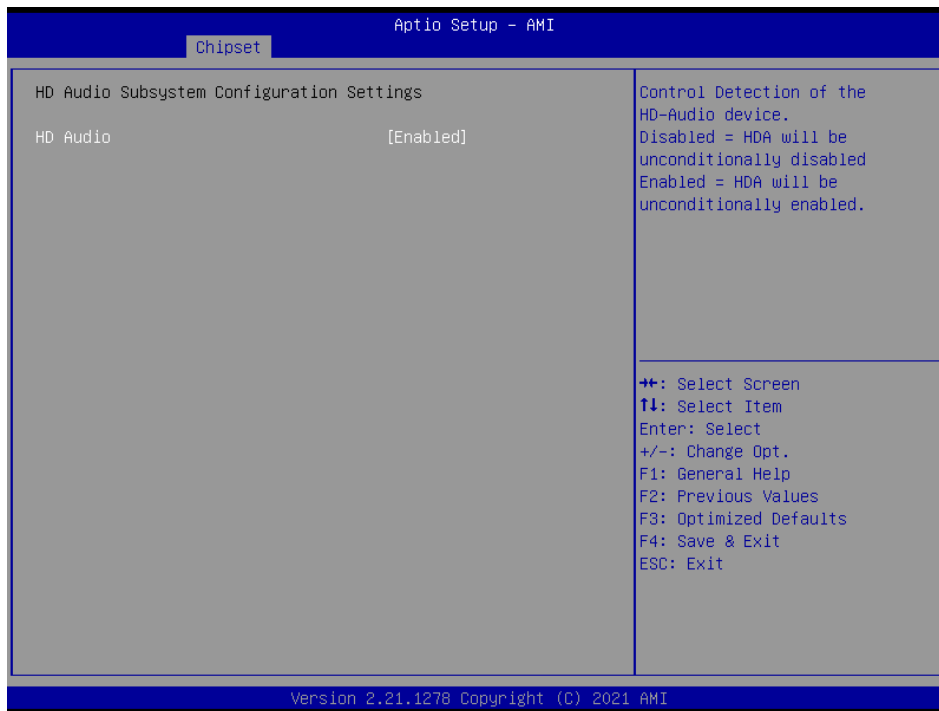

Item	Option	Description
HD Audio	Disabled Enabled[Default]	Control Detection of the HD-Audio device. Disable = HDA will be unconditionally disabled Enabled = HDA will be unconditionally enabled.

3.6.3.3 Board & Panel Configuration

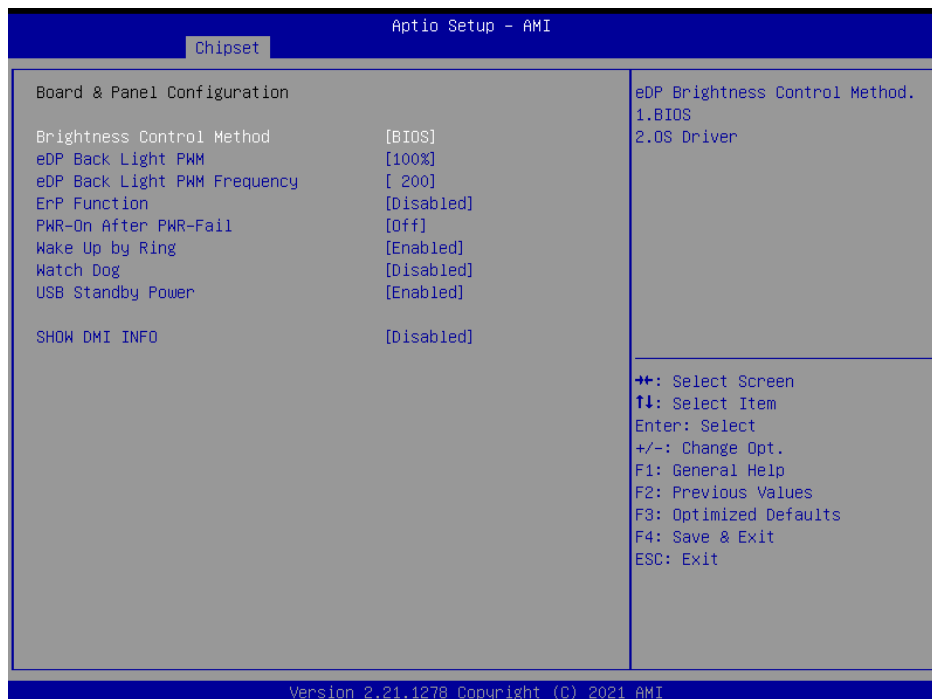

EPC-EHL

Item	Option	Description
Brightness Control Method	BIOS[Default] OS Driver	eDP Brightness Control Method. 1.BIOS 2.OS Driver.
eDP Back Light PWM	00% 25% 50% 75% 100%[Default]	Select eDP back light PWM duty.
eDP Back Light PWM Frequency	200[Default] 300 400 500 700 1k 2k 3k 5k 10k 20k	Select eDP back light PWM Frequency.
ErP Function	Disabled[Default] Enabled	ErP Function (Deep S5).
PWR-On After PWR-Fail	Off[Default] On Last state	AC loss resume.
Wake Up by Ring	Disabled Enabled[Default]	Wake Up by Ring from S3/S4/S5.
Watch Dog	Disabled[Default] 30 sec 40 sec 50 sec 1 min 2 min 10 min 30 min	Select WatchDog.
USB Standby Power	Disabled Enabled[Default]	Enable/Disabled USB Standby Power during S3/S4/S5.
SHOW DMI INFO	Disabled[Default] Enabled	SHOW DMI INFO.

3.6.4 Security



- **Administrator Password**

Set setup Administrator Password

- **User Password**

Set User Password

3.6.4.1 Secure Boot



Item	Option	Description
Secure Boot	Disabled[Default] Enabled	Secure Boot feature is Active if Secure Boot is Enable, Platform Key(PK) is enrolled and the System is in User mode. The mode change requires platform reset.
Secure Boot Mode	Standard Custom[Default]	Secure Boot mode selector: Standard/Custom. In Custom mode Secure Boot Variables can be configured without authentication.

3.6.4.1.1 Key Management

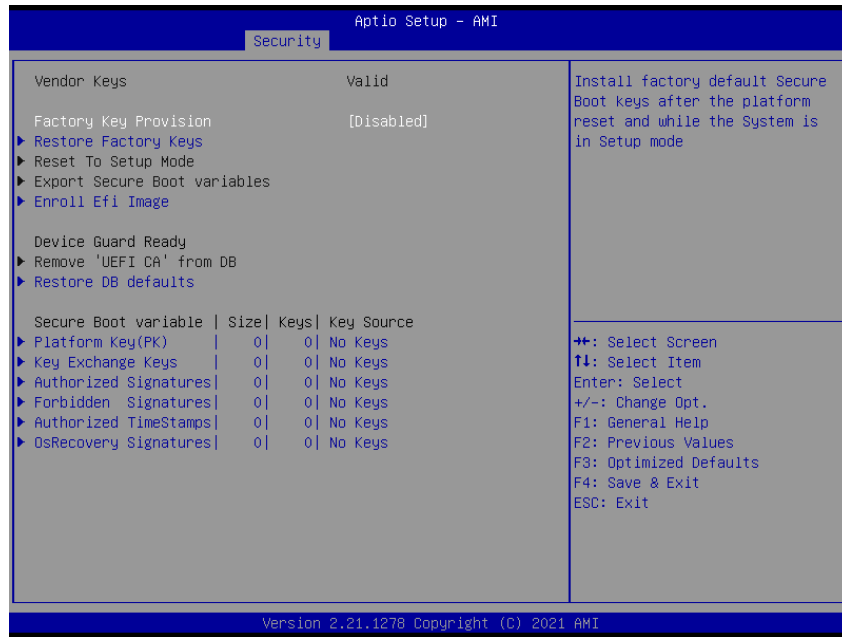

Item	Option	Description
Factory Key Provision	Disabled[Default] Enabled	Install factory default Secure Boot keys after the platform reset and while the System is in Setup mode.

3.6.5 Boot

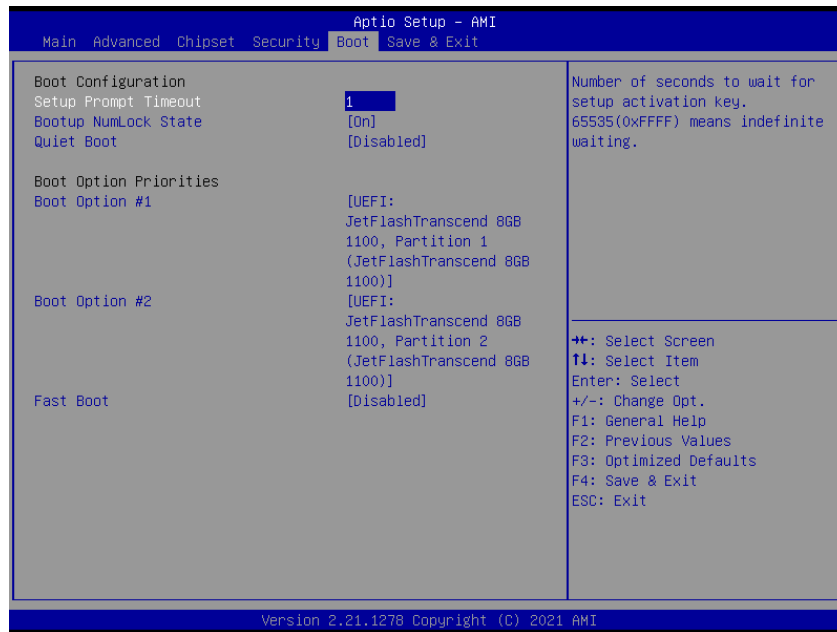

Item	Option	Description
Setup Prompt Timeout	1~ 65535	Number of seconds to wait for setup activation key. 65535(0xFFFF) means indefinite waiting.
Bootup NumLock State	On[Default] Off	Select the keyboard NumLock state
Quiet Boot	Disabled[Default] Enabled	Enables or disables Quiet Boot option
Fast Boot	Disabled[Default] Enabled	Enables or disables boot with initialization of a minimal set of devices required to launch active boot option. Has no effect for BBS boot options.
Boot Option #1/#2	Set the system boot order.	

3.6.6 Save and exit

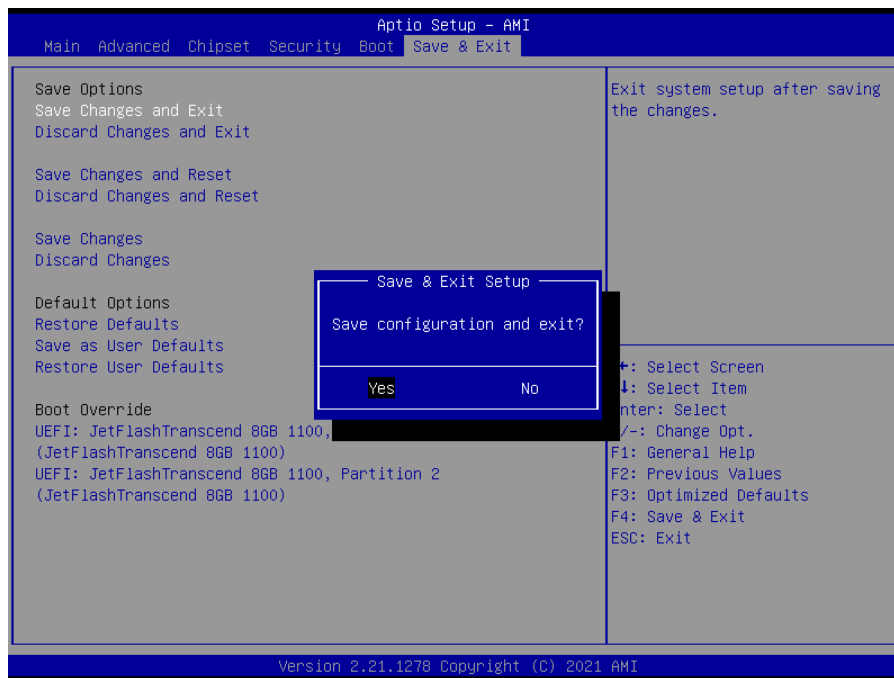
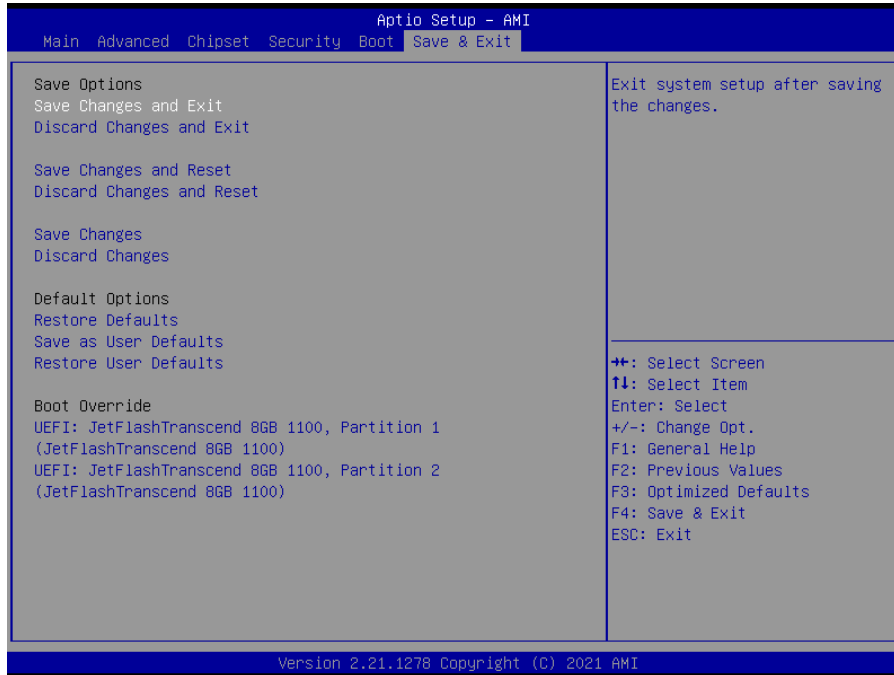

3.6.6.1 Save Changes and Exit

Use the save changes and reset option to save the changes made to the BIOS options and to exit the BIOS configuration setup program.

3.6.6.2 Discard Changes and Exit

Use the Discard changes and Exit option to exit the system without saving the changes made to the BIOS configuration setup program.

3.6.6.3 Save Changes and Reset

Reset the system after saving the changes.

3.6.6.4 Discard Changes and Reset

Any changes made to BIOS settings during this session of the BIOS setup program are discarded. The setup program then exits and reboots the controller.

3.6.6.5 Save Changes

Changes made to BIOS settings during this session are committed to NVRAM. The setup program remains active, allowing further changes.

3.6.6.6 Discard Changes

Any changes made to BIOS settings during this session of the BIOS setup program are discarded. The BIOS setup continues to be active.

3.6.6.7 Restore Defaults

This option restores all BIOS settings to the factory default. This option is useful if the controller exhibits unpredictable behavior due to an incorrect or inappropriate BIOS setting.

3.6.6.8 Save as User Defaults

This option saves a copy of the current BIOS settings as the User Defaults. This option is useful for preserving custom BIOS setup configurations.

3.6.6.9 Restore User Defaults

This option restores all BIOS settings to the user defaults. This option is useful for restoring previously preserved custom BIOS setup configurations.

