

# EPC-BYT2

Intel® Celeron® SoC Processor Fanless Box PC

## Quick Reference Guide

3<sup>rd</sup> Ed – 17 November 2022

### Copyright Notice

Copyright © 2022 Avalue Technology Inc., ALL RIGHTS RESERVED.

## FCC Statement



THIS DEVICE COMPLIES WITH PART 15 FCC RULES. OPERATION IS SUBJECT TO THE FOLLOWING TWO CONDITIONS:

(1) THIS DEVICE MAY NOT CAUSE HARMFUL INTERFERENCE.

(2) THIS DEVICE MUST ACCEPT ANY INTERFERENCE RECEIVED INCLUDING INTERFERENCE THAT MAY CAUSE UNDESIRE OPERATION.

THIS EQUIPMENT HAS BEEN TESTED AND FOUND TO COMPLY WITH THE LIMITS FOR A CLASS "A" DIGITAL DEVICE, PURSUANT TO PART 15 OF THE FCC RULES.

THESE LIMITS ARE DESIGNED TO PROVIDE REASONABLE PROTECTION AGAINST HARMFUL INTERFERENCE WHEN THE EQUIPMENT IS OPERATED IN A COMMERCIAL ENVIRONMENT. THIS EQUIPMENT GENERATES, USES, AND CAN RADIATE RADIO FREQUENCY ENERGY AND, IF NOT INSTALLED AND USED IN ACCORDANCE WITH THE INSTRUCTION MANUAL, MAY CAUSE HARMFUL INTERFERENCE TO RADIO COMMUNICATIONS.

OPERATION OF THIS EQUIPMENT IN A RESIDENTIAL AREA IS LIKELY TO CAUSE HARMFUL INTERFERENCE IN WHICH CASE THE USER WILL BE REQUIRED TO CORRECT THE INTERFERENCE AT HIS OWN EXPENSE.

## A Message to the Customer

### *Avalue Customer Services*

Each and every Avalue's product is built to the most exacting specifications to ensure reliable performance in the harsh and demanding conditions typical of industrial environments. Whether your new Avalue device is destined for the laboratory or the factory floor, you can be assured that your product will provide the reliability and ease of operation for which the name Avalue has come to be known.

Your satisfaction is our primary concern. Here is a guide to Avalue's customer services. To ensure you get the full benefit of our services, please follow the instructions below carefully.

### *Technical Support*

We want you to get the maximum performance from your products. So if you run into technical difficulties, we are here to help. For the most frequently asked questions, you can easily find answers in your product documentation. These answers are normally a lot more detailed than the ones we can give over the phone. So please consult the user's manual first.

To receive the latest version of the user's manual; please visit our Web site at:

<http://www.avalue.com.tw/>

# Content

<b>1. Getting Started</b> .....	<b>4</b>
1.1 Safety Precautions .....	4
1.2 Packing List .....	4
1.3 System Specifications .....	5
1.4 System Overview.....	7
1.4.1 Front View.....	7
1.4.2 Rear View .....	7
1.5 System Dimensions.....	8
1.5.1 Front & Top View .....	8
<b>2. Hardware Configuration</b> .....	<b>9</b>
2.1 EPC-BYT2 connector mapping.....	10
2.1.1 Serial Port 1 connector (COM1).....	10
2.1.2 VGA connector (VGA).....	10
2.2 Installing Hard Disk & Memory (EPC-BYT2) .....	11
2.3 Installing Mounting Brackets (EPC-BYT2).....	12

# 1. Getting Started

## 1.1 Safety Precautions

### Warning!



Always completely disconnect the power cord from your chassis whenever you work with the hardware. Do not make connections while the power is on. Sensitive electronic components can be damaged by sudden power surges. Only experienced electronics personnel should open the PC chassis.

### Caution!



Always ground yourself to remove any static charge before touching the CPU card. Modern electronic devices are very sensitive to static electric charges. As a safety precaution, use a grounding wrist strap at all times. Place all electronic components in a static-dissipative surface or static-shielded bag when they are not in the chassis.

## 1.2 Packing List

- 1 x EPC-BYT2 Intel® Celeron® SoC Processor Fanless Box PC
- Other major components include the followings:
  - Screw kit
  - Adapter



---

If any of the above items is damaged or missing, contact your retailer.

---

## 1.3 System Specifications

System	
Board	<ul style="list-style-type: none"> <li>ECM-BYT2</li> </ul>
CPU	<ul style="list-style-type: none"> <li>Intel® Celeron® Processor J1900 Family</li> </ul>
BIOS	<ul style="list-style-type: none"> <li>AMI uEFI BIOS, 64Mbit SPI Flash ROM</li> </ul>
System Chipset	<ul style="list-style-type: none"> <li>Valleyview D SoC Integrated</li> </ul>
I/O Chipset	<ul style="list-style-type: none"> <li>EC ITE IT8528E</li> </ul>
System Memory	<ul style="list-style-type: none"> <li>One 204-pin SODIMM Socket Up to 8GB DDR3L 1333MHz SDRAM</li> </ul>
Watchdog Timer	<ul style="list-style-type: none"> <li>H/W Reset, 1sec. ~ 65535sec./1sec.step</li> </ul>
H/W Status Monitor	<ul style="list-style-type: none"> <li>Monitoring System Temperature, Voltage with Auto Throttling Control</li> </ul>
Storage	
Solid State Drive	<ul style="list-style-type: none"> <li>1 x mSATA</li> <li>1 x 2.5" Drive Bay</li> </ul>
External I/O	
COM Port	<ul style="list-style-type: none"> <li>1 x RS-232</li> </ul>
USB Port	<ul style="list-style-type: none"> <li>4 x USB (1 x USB 3.0, 3 x USB 2.0)</li> </ul>
Video Port	<ul style="list-style-type: none"> <li>1 x VGA, 1 X HDMI</li> </ul>
LAN Port	<ul style="list-style-type: none"> <li>2 x RJ45</li> </ul>
Switch	<ul style="list-style-type: none"> <li>1 x Power on/off membrane w/ LED</li> </ul>
Indicator Light	<ul style="list-style-type: none"> <li>1 x Power on/off LED on rear side</li> <li>1 x Storage LED on rear side</li> </ul>
Antenna	<ul style="list-style-type: none"> <li>2 x Antenna mounting</li> </ul>
Expansion Slots	<ul style="list-style-type: none"> <li>1 x Full Size Mini PCIe (mSATA supported)</li> <li>1 x Half Size Mini PCIe</li> </ul>
Display	
Chipset	<ul style="list-style-type: none"> <li>Intel® Celeron® SoC Integrated Graphics</li> </ul>
Multiple Display	<ul style="list-style-type: none"> <li>Dual Display, VGA + HDMI</li> </ul>
Resolution	<ul style="list-style-type: none"> <li>VGA Mode: 2560 x 1600 @ 60Hz</li> <li>HDMI Mode: 1920 x 1200 @ 60Hz</li> </ul>
Ethernet	
Chipset	<ul style="list-style-type: none"> <li>2 x Realtek RTL8111E Gigabit Ethernet</li> </ul>
Ethernet Interface	<ul style="list-style-type: none"> <li>10/100/1000 Base-Tx Gigabit Ethernet Compatible</li> </ul>
Mechanical	
Power Type	<ul style="list-style-type: none"> <li>+12 ~ 26Vdc (Lockable DC Jack)</li> </ul>
ACPI	<ul style="list-style-type: none"> <li>Single Power ATX Support S0, S3, S4, S5</li> <li>ACPI 3.0 Compliant</li> </ul>

## EPC-BYT2

<b>Power Mode</b>	<ul style="list-style-type: none"><li>• AT/ATX (ATX is the default setting)</li></ul>
<b>Operating Temperature</b>	<ul style="list-style-type: none"><li>• -10 ~ +45°C (w/mSATA &amp; SSD), Ambient w/Air Flow</li><li>• 0 ~ 40°C (32 ~ 104°F) (w/HDD), Ambient w/Air Flow</li></ul>
<b>Storage Temperature</b>	<ul style="list-style-type: none"><li>• -40 ~ 75°C (-40 ~ 167°F)</li></ul>
<b>Relative Humidity</b>	<ul style="list-style-type: none"><li>• 0% ~ 90% Relative Humidity, Non-condensing</li></ul>
<b>Vibration Protection</b>	<ul style="list-style-type: none"><li>• With CF/SSD: 1.5Grms, IEC 60068-2-64, Random, 5 ~ 500Hz, 30min/axis</li></ul>
<b>Shock Protection</b>	<ul style="list-style-type: none"><li>• With CF/SSD: 10G, IEC 60068-2-27, Half Sine, 11ms</li></ul>
<b>Certification</b>	<ul style="list-style-type: none"><li>• CE, FCC Class A</li></ul>
<b>Dimension (W x D x H)</b>	<ul style="list-style-type: none"><li>• 175mm x 110mm x 40mm</li></ul>
<b>Color</b>	<ul style="list-style-type: none"><li>• Black</li></ul>
<b>Fanless</b>	<ul style="list-style-type: none"><li>• YES</li></ul>



**Note:** Specifications are subject to change without notice.

## 1.4 System Overview

### 1.4.1 Front View



### Connectors

Label	Function	Note
POWER	Power on button	

### 1.4.2 Rear View

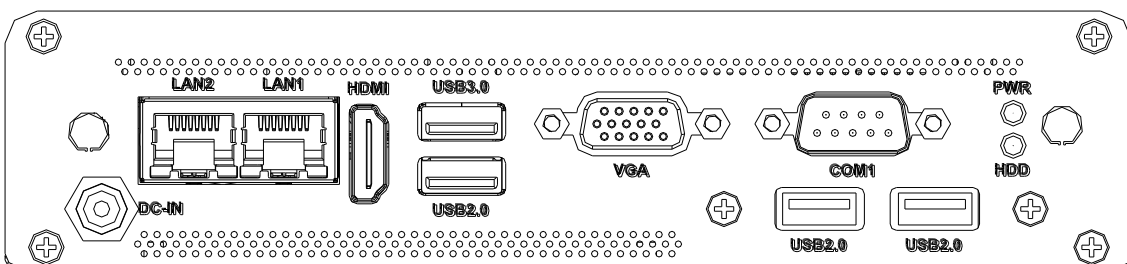

### Connectors

Label	Function	Note
COM1	Serial port 1 connector	D-sub 9-pin, male
HDD	HDD indicator	
LAN1/2	RJ-45 Ethernet 1/2 with (L)LED for ACT/LINK and (R)LED for speed	
PWR	System power indicator	
USB2.0	USB 2.0 connector x 3	
USB3.0	USB 3.0 connector	
VGA	VGA connector	DB-15 female connector
HDMI	HDMI connector	
DC-IN	DC Power-in connector	

## 1.5 System Dimensions

### 1.5.1 Front & Top View

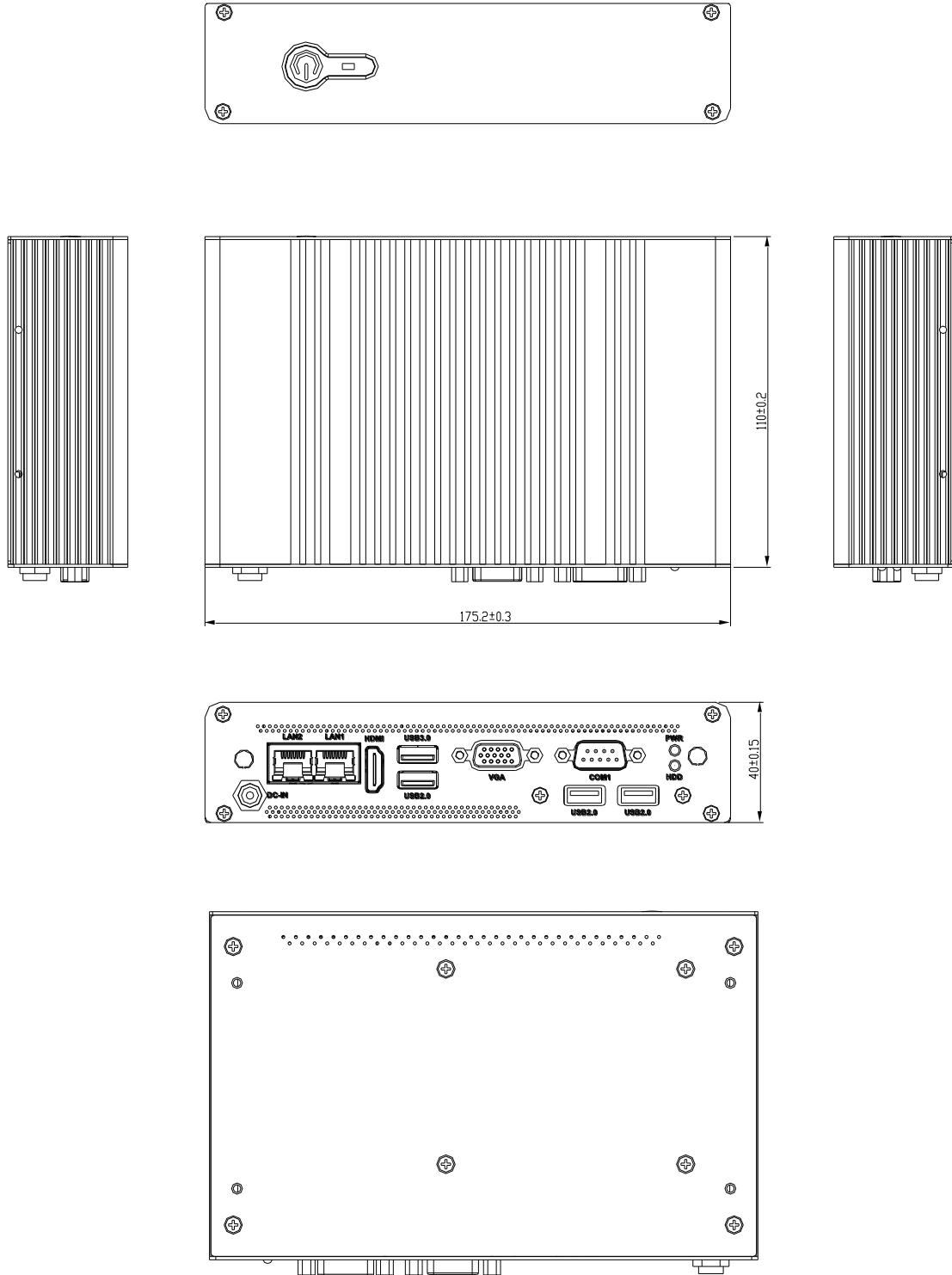

(Unit: mm)



# 2. Hardware Configuration

---

For advanced information, please refer to:

- 1- ECM-BYT2 User's Manual



**Note:** If you need more information, please visit our website:

<http://www.avalue.com.tw>

## 2.1 EPC-BYT2 connector mapping

### 2.1.1 Serial Port 1 connector (COM1)

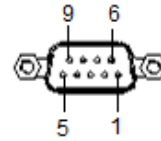
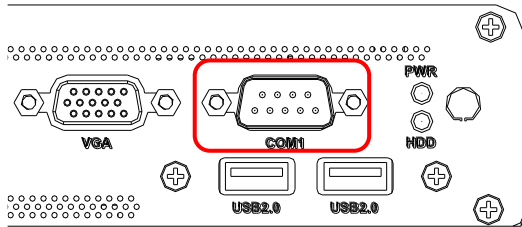

Signal	PIN	PIN	Signal
NDCD#	1	6	NDSR#
NRXD	2	7	NRTS#
NTXD	3	8	NCTS#
NDTR#	4	9	NRI#
GND	5		

### 2.1.2 VGA connector (VGA)

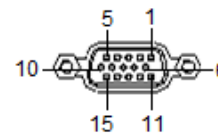
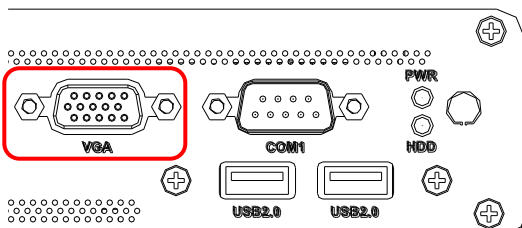

PIN	Signal	PIN	Signal	PIN	Signal
1	R	6	GND	11	NC
2	G	7	GND	12	DATA
3	B	8	GND	13	HSYNC
4	NC	9	+5V	14	VSYNC
5	GND	10	GND	15	CLK

## 2.2 Installing Hard Disk & Memory (EPC-BYT2)

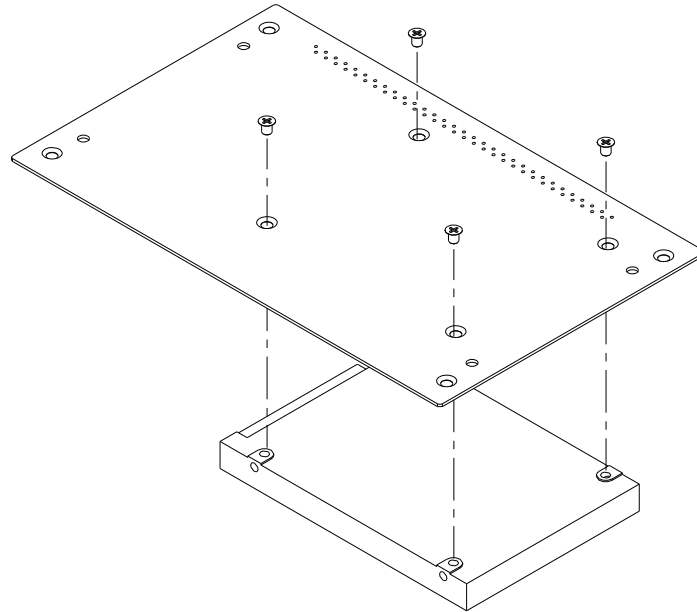

**Step1.** Fix HDD using the 4 screws in the Accessory Kit.

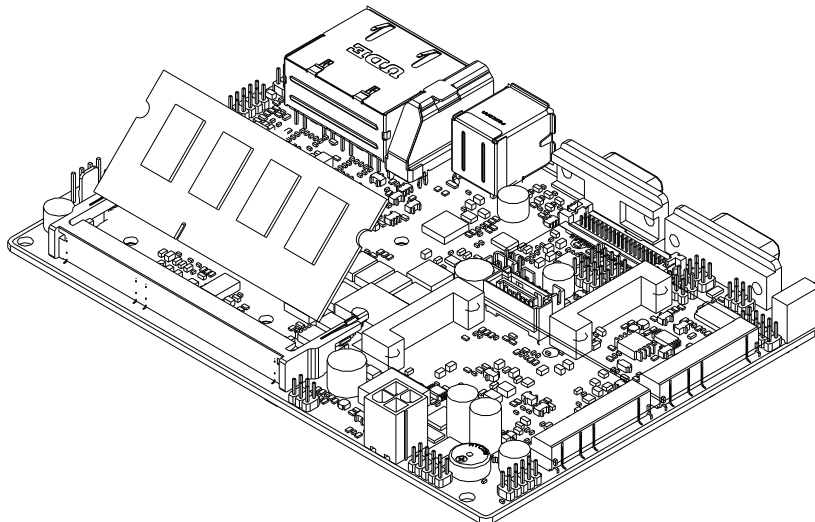

**Step2.** Properly install the memory module and press until properly seated.

## 2.3 Installing Mounting Bracket (EPC-BYT2)

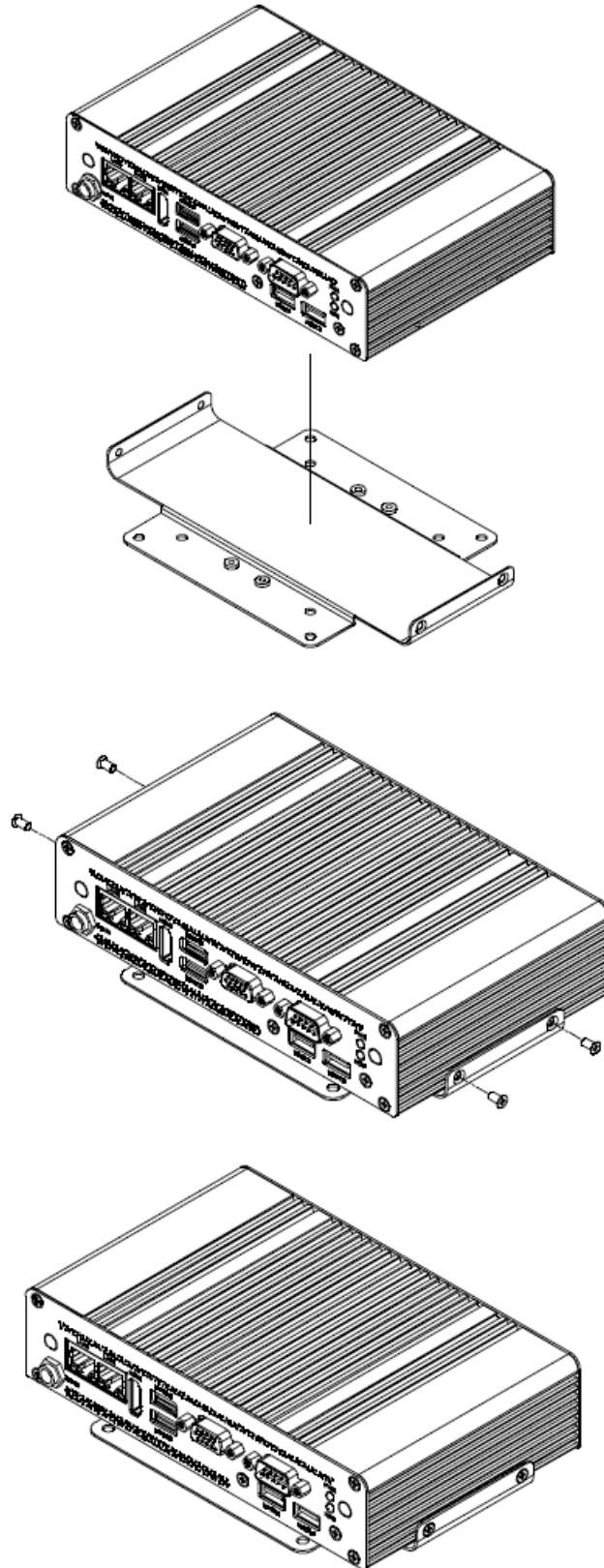

**Step1.** Insert and fasten 4 screws on each side of the system to secure Mounting bracket.

