

ESM-EHLC

PICMG COM.0 R3.0 Type 6 Compact module with on board
Intel® Elkhart Lake series Platform

User's Manual

1st Ed –31 May 2022

Copyright Notice

Copyright © 2022 Avalue Technology Inc., ALL RIGHTS RESERVED.

Part No. E2047290400R

FCC Statement



THIS DEVICE COMPLIES WITH PART 15 FCC RULES. OPERATION IS SUBJECT TO THE FOLLOWING TWO CONDITIONS:

(1) THIS DEVICE MAY NOT CAUSE HARMFUL INTERFERENCE.

(2) THIS DEVICE MUST ACCEPT ANY INTERFERENCE RECEIVED INCLUDING INTERFERENCE THAT MAY CAUSE UNDESIRE OPERATION.

THIS EQUIPMENT HAS BEEN TESTED AND FOUND TO COMPLY WITH THE LIMITS FOR A CLASS "A" DIGITAL DEVICE, PURSUANT TO PART 15 OF THE FCC RULES.

THESE LIMITS ARE DESIGNED TO PROVIDE REASONABLE PROTECTION AGAINST HARMFUL INTERFERENCE WHEN THE EQUIPMENT IS OPERATED IN A COMMERCIAL ENVIRONMENT. THIS EQUIPMENT GENERATES, USES, AND CAN RADIATE RADIO FREQUENCY ENERGY AND, IF NOT INSTALLED AND USED IN ACCORDANCE WITH THE INSTRUCTION MANUAL, MAY CAUSE HARMFUL INTERFERENCE TO RADIO COMMUNICATIONS.

OPERATION OF THIS EQUIPMENT IN A RESIDENTIAL AREA IS LIKELY TO CAUSE HARMFUL INTERFERENCE IN WHICH CASE THE USER WILL BE REQUIRED TO CORRECT THE INTERFERENCE AT HIS OWN EXPENSE.

Notice

This guide is designed for experienced users to setup the system within the shortest time. For detailed information, please always refer to the electronic user's manual.

Copyright Notice

Copyright © 2022 Avalue Technology Inc., ALL RIGHTS RESERVED.

No part of this document may be reproduced, copied, translated, or transmitted in any form or by any means, electronic or mechanical, for any purpose, without the prior written permission of the original manufacturer.

Trademark Acknowledgement

Brand and product names are trademarks or registered trademarks of their respective owners.

Disclaimer

Avalue Technology Inc. reserves the right to make changes, without notice, to any product, including circuits and/or software described or contained in this manual in order to improve design and/or performance. Avalue Technology assumes no responsibility or liability for the use of the described product(s), conveys no license or title under any patent, copyright, or masks work rights to these products, and makes no representations or warranties that

these products are free from patent, copyright, or mask work right infringement, unless otherwise specified. Applications that are described in this manual are for illustration purposes only. Avalue Technology Inc. makes no representation or warranty that such application will be suitable for the specified use without further testing or modification.

Life Support Policy

Avalue Technology's PRODUCTS ARE NOT FOR USE AS CRITICAL COMPONENTS IN LIFE SUPPORT DEVICES OR SYSTEMS WITHOUT THE PRIOR WRITTEN APPROVAL OF Avalue Technology Inc.

As used herein:

1. Life support devices or systems are devices or systems which, (a) are intended for surgical implant into body, or (b) support or sustain life and whose failure to perform, when properly used in accordance with instructions for use provided in the labeling, can be reasonably expected to result in significant injury to the user.
2. A critical component is any component of a life support device or system whose failure to perform can be reasonably expected to cause the failure of the life support device or system, or to affect its safety or effectiveness.

A Message to the Customer

Avalue Customer Services

Each and every Avalue's product is built to the most exacting specifications to ensure reliable performance in the harsh and demanding conditions typical of industrial environments. Whether your new Avalue device is destined for the laboratory or the factory floor, you can be assured that your product will provide the reliability and ease of operation for which the name Avalue has come to be known.

Your satisfaction is our primary concern. Here is a guide to Avalue's customer services. To ensure you get the full benefit of our services, please follow the instructions below carefully.

Technical Support

We want you to get the maximum performance from your products. So if you run into technical difficulties, we are here to help. For the most frequently asked questions, you can easily find answers in your product documentation. These answers are normally a lot more detailed than the ones we can give over the phone. So please consult the user's manual first.

To receive the latest version of the user's manual; please visit our Web site at:

<http://www.avalue.com.tw/>

CONTENT

1. Getting Started	7
1.1 Safety Precautions	7
1.2 Packing List.....	7
1.3 Document Amendment History	8
1.4 Manual Objectives.....	9
1.5 System Specifications	10
1.6 Architecture Overview—Block Diagram	13
2. Hardware Configuration	14
2.1 Product Overview.....	15
2.2 Connector List.....	16
2.3 Setting Jumpers & Connectors	17
2.3.1 AT/ATX mode selector (SW1).....	17
2.3.1.1 Signal Description –AT/ATX mode selection.....	17
2.3.2 COM Express Connector 1 (CN1A)	18
2.3.2.1 Signal Description – COM Express Connector 1 (CN1A).....	22
2.3.2.1.1 Audio Signals	22
2.3.2.1.2 Gigabit Ethernet Signals	22
2.3.2.1.3 PCI Express Signals.....	22
2.3.2.1.4 Flat Panel LVDS Signals.....	22
2.3.2.1.5 LPC/eSPI Signals.....	23
2.3.2.1.6 GPIO Signals.....	23
2.3.2.1.7 Power & System Management Signals.....	23
2.3.2.1.8 SATA Signals	25
2.3.2.1.9 USB Signals	25
2.3.2.1.10 I2C Signals	25
2.3.2.1.11 USB3.0 Signals	25
2.3.3 COM Express Connector 2 (CN1B)	26
2.3.3.1 Signal Description – COM Express Connector 2 (CN1B).....	30
2.3.3.1.1 USB3.0 Signals	30
2.3.3.1.2 DDI Signals.....	30
2.4 Installing Heatsink / Heat spreader	31
3. BIOS Setup	33
3.1 Introduction	34
3.2 Starting Setup	34

3.3	Using Setup	35
3.4	Getting Help	36
3.5	In Case of Problems.....	36
3.6	BIOS setup.....	37
3.6.1	Main Menu.....	37
3.6.1.1	System Language.....	38
3.6.1.2	System Date	38
3.6.1.3	System Time.....	38
3.6.2	Advanced Menu	39
3.6.2.1	CPU Configuration.....	40
3.6.2.2	Power & Performance	41
3.6.2.2.1	CPU – Power Management Control	41
3.6.2.2.2	GT – Power Management Control.....	43
3.6.2.3	PCH-FW Configuration	44
3.6.2.3.1	Firmware Update Configuration.....	44
3.6.2.3.2	PTT Configuration.....	45
3.6.2.4	Trusted Computing	46
3.6.2.5	APCI Settings	46
3.6.2.6	IT5571 Super IO Configuration.....	47
3.6.2.6.1	Serial Port 1 Configuration	48
3.6.2.6.2	Serial Port 2 Configuration	48
3.6.2.7	HW Monitor.....	49
3.6.2.7.1	Smart Fan Mode Configuration	50
3.6.2.8	S5 RTC Wake Settings.....	51
3.6.2.9	Serial Port Console Redirection	53
3.6.2.9.1	COM0	53
3.6.2.9.2	Console Redirection Settings	55
3.6.2.10	USB Configuration	55
3.6.2.11	Network Stack Configuration	57
3.6.2.12	NVMe Configuration	59
3.6.2.13	User Password Management	59
3.6.3	Chipset.....	60
3.6.3.1	System Agent (SA) Configuration.....	60
3.6.3.1.1	Memory Configuration	61
3.6.3.1.2	Graphics Configuration	62
3.6.3.2	PCH-IO Configuration.....	63
3.6.3.2.1	PCI Express Configuration	63
3.6.3.2.2	SATA And RST Configuration	69
3.6.3.2.3	USB Configuration	70
3.6.3.2.4	HD Audio Configuration	71

ESM-EHLC User's Manual

3.6.3.2.5	SCS Configuration	71
3.6.3.3	Board & Panel Configuration	72
3.6.4	Security	74
3.6.5	Boot	75
3.6.6	Save and exit	76
3.6.6.1	Save Changes and Reset	76
3.6.6.2	Discard Changes and Reset	76
3.6.6.3	Restore Defaults	76
3.6.6.4	Launch EFI Shell from filesystem device	76
4.	Drivers Installation	77
4.1	Install Chipset Driver	78
4.2	Install HID Driver	79
4.3	Install VGA Driver	80
4.4	Install Audio Driver	81
4.5	Install Ethernet Driver	82
4.6	Install ME Driver	84
4.7	Install SIO Driver	85
5.	Mechanical Drawing	86

1. Getting Started

1.1 Safety Precautions

Warning!



Always completely disconnect the power cord from your chassis whenever you work with the hardware. Do not make connections while the power is on. Sensitive electronic components can be damaged by sudden power surges. Only experienced electronics personnel should open the PC chassis.

Caution!



Always ground yourself to remove any static charge before touching the CPU card. Modern electronic devices are very sensitive to static electric charges. As a safety precaution, use a grounding wrist strap at all times. Place all electronic components in a static-dissipative surface or static-shielded bag when they are not in the chassis.

1.2 Packing List

Before you begin installing your single board, please make sure that the following materials have been shipped:

- 1 x ESM-EHLC COMe Module
- 1 x Desiccant (5g)
- 4 x Screws



If any of the above items is damaged or missing, contact your retailer.

1.3 Document Amendment History

Revision	Date	By	Comment
1 st	May 2022	Avalue	Initial Release

1.4 Manual Objectives

This manual describes in details Avalue Technology ESM-EHLC Single Board.

We have tried to include as much information as possible but we have not duplicated information that is provided in the standard IBM Technical References, unless it proved to be necessary to aid in the understanding of this board.

We strongly recommend that you study this manual carefully before attempting to set up ESM-EHLC series or change the standard configurations. Whilst all the necessary information is available in this manual we would recommend that unless you are confident, you contact your supplier for guidance.

Please be aware that it is possible to create configurations within the NVRAM that make booting impossible. If this should happen, clear the NVRAM settings, (see the description of the Jumper Settings for details).

If you have any suggestions or find any errors regarding this manual and want to inform us of these, please contact our Customer Service department with the relevant details.

1.5 System Specifications

System	
CPU	Onboard Intel® Celeron®/ Pentium®/Atom™ SoC BGA Processor (Elkhart Lake Platform 6~12W)
BIOS	AMI uEFI BIOS, 256 Mbit SPI Flash ROM
System Chipset	Elkhart lake SoC integrated
I/O Chip	EC ITE IT5571
System Memory	Two 260-pin SODIMM DDR4 3200 SDRAM slot up to 32GB
Watchdog Timer	H/W Reset, 1sec. ~ 65535sec. and 1sec./step
H/W Status Monitor	Monitoring System Temperature, Voltage and FAN Status with Auto Throttling Control
TPM	TPM 2.0 (Optional, NuvoTon NPCT754AADYX SPI Interface E14S4075401H, wide temp version, Co-lay with Infineon solution)
Storage	
eMMC	eMMC 5.1 up to 128 GB (build option)
I/O Interface (SOM)	
PCI Express	3 PCIe1 Gen3 (8.0 GT/s)
UART	2 x UART(2-wire)
USB 2.0	8 x USB 2.0
USB 3.1	4 x USB 3.2 Gen2x1 (10 Gbps)
SATA	2 x SATA3.0 (6.0Gb/s)
LPC/eSPI	1x LPC (via eSPI-to-LPC bridge), or 1x eSPI (Only support 20MHz), build option.
I2C Bus	1 x I2C
SMBus	SMBus
SD	SD Optional (SD signal share with GPIO, default is GPIO, controlled by BIOS and BOM setting)
SPI	1 x SPI
Others	8bit GPIO
Display	
Graphic Chipset	Intel® Elkhart Lake SoC Processor integrated Gen11 LP graphics
Spec. & Resolution	<p>HDMI 1.4b/2.0b: 4096x2160 @60Hz</p> <p>DP 1.4: 4096x2160 @60Hz Per Intel design guide, need to add Redriver (Redriver in carrier board to fine tune the signal of DP1.4).</p> <p>eDP 1.3b(Optional): 4096x2160 @60Hz (Only support 4Lanes 2560x1440 & 2Lanes 1920x1080)</p> <p>LVDS(via eDP-to-LVDS): 1920x1080 @60Hz, LVDS via CH7511B</p> <p>VGA(via DP-to-VGA): 1920x1080 @60Hz, VGA via CH7517A (DP to VGA)</p>

Multiple Display	Maximum of 3 Simultaneous Displays						
	Maximum of 3 Simultaneous Displays						
		1 Display Only		2 Displays		3 Displays	
		1 Internal	1 External	1 Internal + 1 External	2 External	1 Internal + 2 External	3 External
	Internal #1	eDP 1.3b ² : 4096x2160 60Hz (Single port) MIPI-DSI: 4096x2160 @ 60Hz (w. compression)	N/A	eDP 1.3b ² : 4096 x 2160 @ 60Hz MIPI-DSI: 4096 x 2160 @ 60Hz	N/A	eDP 1.3b ² : 4096 x 2160 @ 60Hz MIPI-DSI: 4096 x 2160 @ 60Hz	N/A
External #1	N/A	DP 1.4 ² : 4096x2160 @ 60Hz 4096x2160 @120Hz (w.compression) HDMI 2.0b: 4096 x 2160 @ 60Hz	DP 1.4 ² : 4096 x 2160 @ 60Hz HDMI 2.0b: 4096 x 2160 @ 60Hz	DP 1.4 ² : 4096 x 2160 @ 60Hz HDMI 2.0b: 4096 x 2160 @ 60Hz	DP 1.4 ² : 4096 x 2160 @ 60Hz HDMI 2.0b: 4096 x 2160 @ 60Hz	DP 1.4 ² : 4096 x 2160 @ 60Hz HDMI 2.0b: 4096 x 2160 @ 60Hz	
External #2	N/A	N/A	N/A	DP 1.4 ² : 4096 x 2160 @ 60Hz HDMI 2.0b: 4096 x 2160 @ 60Hz	DP 1.4 ² : 4096 x 2160 @ 60Hz HDMI 2.0b: 4096 x 2160 @ 60Hz	DP 1.4 ² : 4096 x 2160 @ 60Hz HDMI 2.0b: 4096 x 2160 @ 60Hz	
External #3	N/A	N/A	N/A	N/A	N/A	DP 1.4 ² : 4096 x 2160 @ 60Hz HDMI 2.0b: 4096 x 2160 @ 60Hz	
	Notes: Depends on vary carrier board.						
Digital Display Interface (SOM)	HDMI/DP (default)						
Audio							
Audio Codec	Intel® HD Audio integrated in SoC						
Ethernet							
LAN Chipset	1 x Intel KTI225LM for STD-Temp. SKU 1 x Intel KTI225IT for Wide-Temp. SKU						
LAN Spec.	1 x 10BASE-TE/100BASE-TX/1000BASE-T/2500BASE-T compatible Gigabit, above 70°C Tc, the recommended speed is 1G.						
Mechanical & Environmental							
Power Requirement	+9~ +19V						
ACPI	Single power ATX Support S0, S3, S4, S5 ACPI 6.0Compliant						
Power Mode	AT/ATX						
Operating Temp.	Operating Standard: 0°C ~ 60°C with 0.2m/s air flow Conditional extend: -40°C ~ 85°C with 0.5m/s air flow. (Note: Above 70°C Tc, the recommended ethernet speed is 1G.)						
Storage Temp.	-40°C ~ 85°C (-40°F ~ 185°F)						
Operating Humidity	40°C @ 95% Relative Humidity, Non-condensing						
Size (L x W) (Please consult product engineers for the production feasibility if the size is larger than 410x360mm or smaller than 80x70mm)	95 x 95 mm (3.74" x 3.74")						
Weight	0.44lbs(0.2kg)						

ESM-EHLC User's Manual

<p>Vibration Test</p>	<p>Random Vibration Operation 1 Test PSD : 0.00454G²/Hz , 1.5 Grms 2 System condition : operation mode 3 Test frequency : 5~500 Hz 4 Test axis : X,Y and Z axis 5 Test time : 30 minutes per each axis 6 IEC60068-2-64 Test Fh 6 Storage : mSATA</p> <p>Random vibration test (Non-operation)</p> <p>1 PSD: 0.01818G²/Hz , 3.0 Grms</p> <p>2 Non-Operation mode</p> <p>3 Test Frequency : 5-500Hz</p> <p>4 Test Axis : X,Y and Z axis</p> <p>5 30 min. per each axis</p> <p>6 IEC 60068-2-64 Test:Fh</p> <p>Package Vibration Test:</p> <p>1 Test PSD : 0.026G²/Hz , 2.16 Grms</p> <p>2 Test frequency : 5~500 Hz</p> <p>3 Test axis : X,Y and Z axis</p> <p>4 Test time : 30 minutes per each axis</p> <p>5 IEC 60068-2-64 Test Fh</p>
<p>Shock Test</p>	<p>1 Wave from : Half Sine wave</p> <p>2 Acceleration Rate : 10g</p> <p>3 Duration Time : 11ms</p> <p>4 No. of shock : Z axis 300 times</p> <p>5 Test Axis : Z axis</p> <p>6 operation mode</p> <p>7 Reference IEC 60068-2-27 testing procedures Test Eb : Shock Test</p>
<p>Drop Test</p>	<p>Package drop test</p> <p>Reference ISTA 2A, Method : IEC-60068-2-32 Test:Ed Test Ea : Drop Test</p> <p>1 Test phase : One corner, three edges, six faces</p> <p>2 Test high : 96.5cm</p> <p>3 Package weight : 5Kg</p> <p>4 Test drawing</p>
<p>OS Information</p>	<p>Windows* 10 IoT Enterprise (64-bit), Linux</p>
<p>Carrier</p>	<p>Carrier: with EEV-EX16 B1 version</p>
<p>Others</p>	<p>Sample build included BOM1 & 2, BOM3 RD will adjust component and offer for testing</p>



Note: Specifications are subject to change without notice.

1.6 Architecture Overview—Block Diagram

The following block diagram shows the architecture and main components of ESM-EHLC.

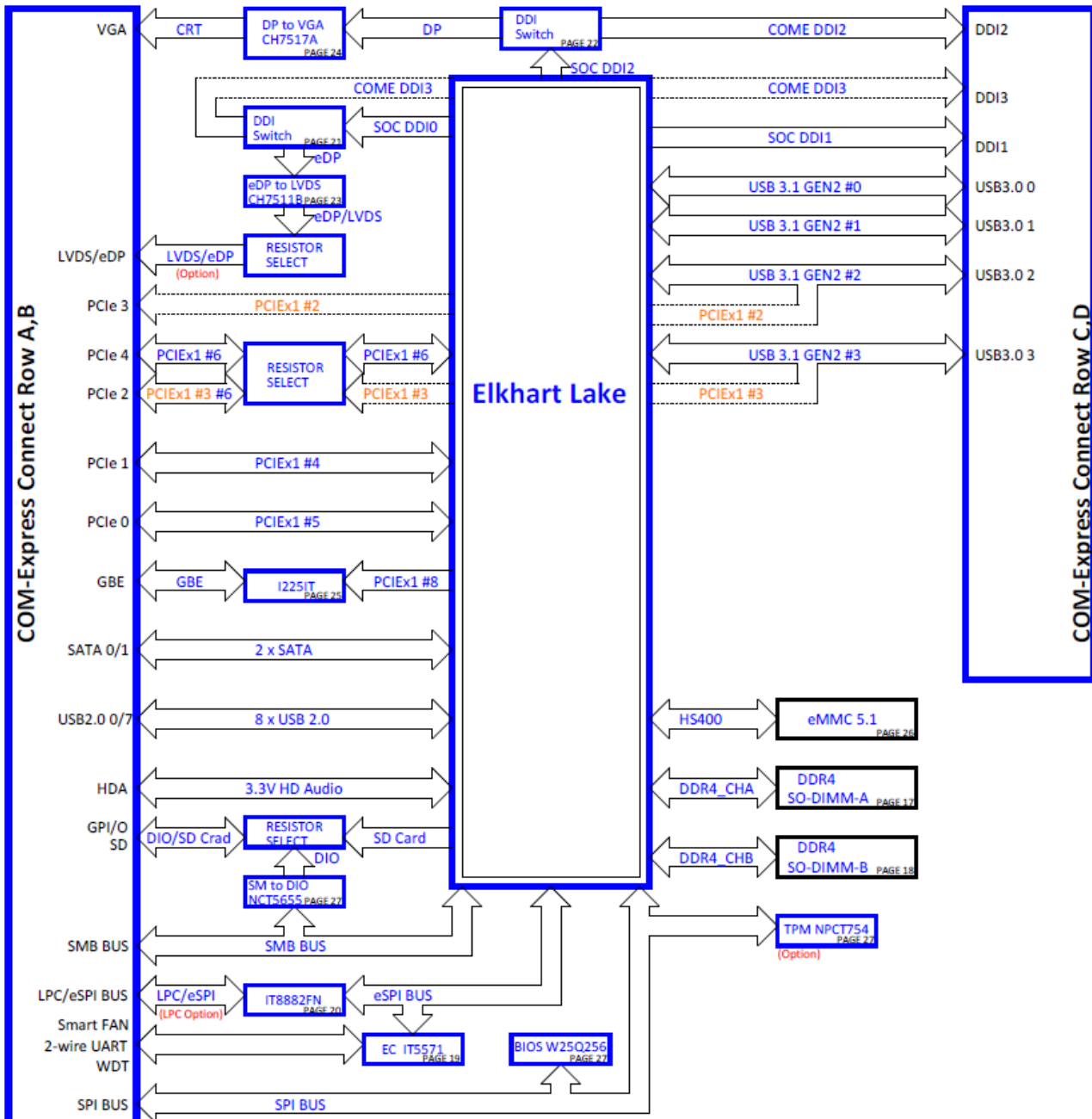

2. Hardware Configuration

2.1 Product Overview

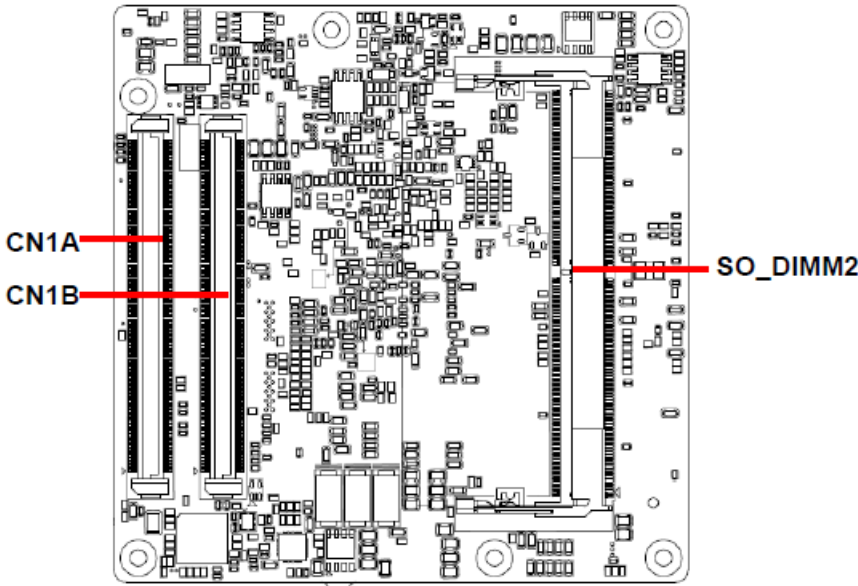
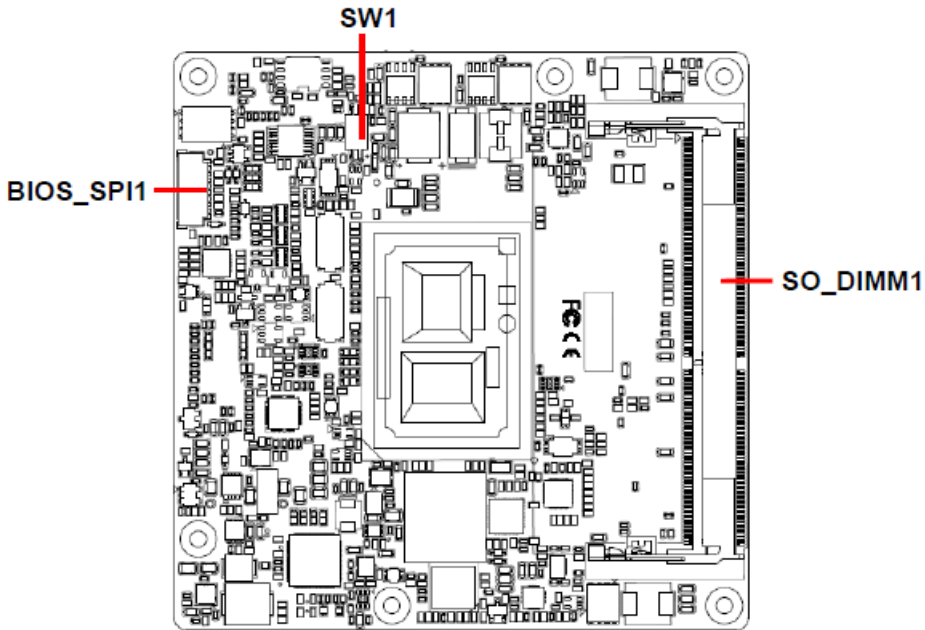

2.2 Connector List

You can configure your board to match the needs of your application by setting jumpers. A jumper is the simplest kind of electric switch.

It consists of two metal pins and a small metal clip (often protected by a plastic cover) that slides over the pins to connect them. To “close” a jumper you connect the pins with the clip. To “open” a jumper you remove the clip. Sometimes a jumper will have three pins, labeled 1, 2, and 3. In this case, you would connect either two pins.

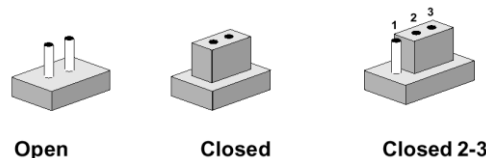

The jumper settings are schematically depicted in this manual as follows:



A pair of needle-nose pliers may be helpful when working with jumpers.

Connectors on the board are linked to external devices such as hard disk drives, a keyboard, or floppy drives. In addition, the board has a number of jumpers that allow you to configure your system to suit your application.

If you have any doubts about the best hardware configuration for your application, contact your local distributor or sales representative before you make any changes.

The following tables list the function of each of the board’s jumpers and connectors.

Connectors

Label	Function	Note
BIOS_SPI1	(Reserved for BIOS programming)	5 x 2 header, pitch 2.00mm
CN1A	COM Express connector 1	
CN1B	COM Express connector 2	
SODIMM1	260-pin DDR4 SDRAM DIMM socket	
SODIMM2	260-pin DDR4 SDRAM DIMM socket	
SW1	AT/ATX mode selector	

2.3 Setting Jumpers & Connectors

2.3.1 AT/ATX mode selector (SW1)

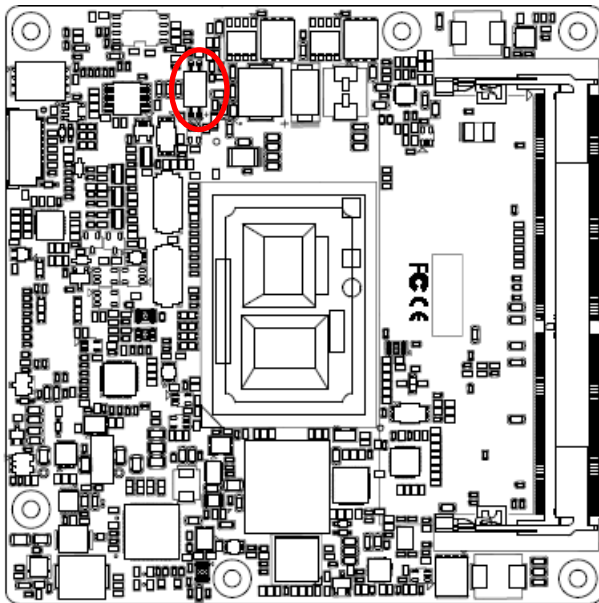

*Default

AT/ATX mode



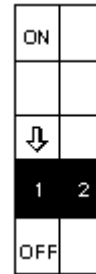
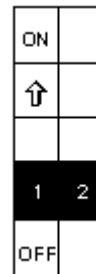

AT mode

ATX mode*



2.3.1.1 Signal Description –AT/ATX mode selection

AT/ATX mode	Description
<p>AT mode</p> <p>on</p>  <p>12</p>	<p>Auto power on, no need to press Power button to enable power on/off</p>
<p>ATX mode</p> <p>on</p>  <p>12</p>	<p>Press the ATX power button to enable power on/off</p>

2.3.2 COM Express Connector 1 (CN1A)

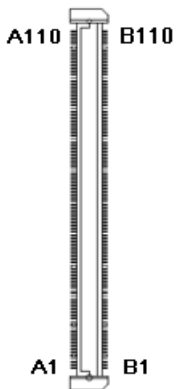
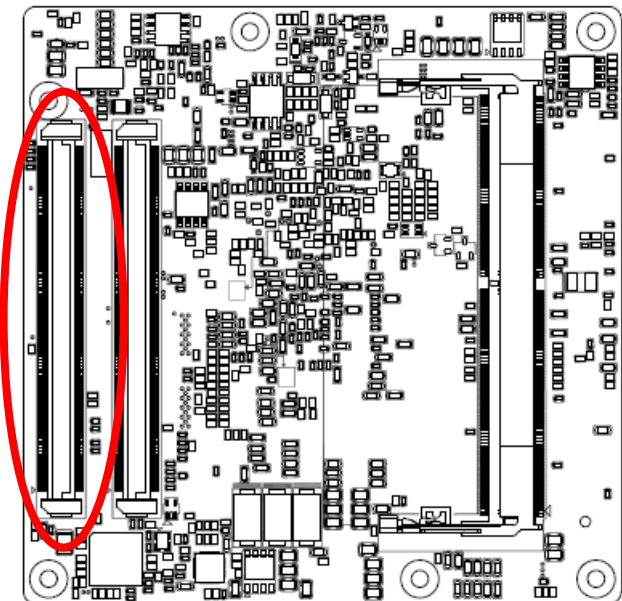

Signal	PIN	PIN	Signal
GND	A110	B110	GND
VCC	A109	B109	VCC
VCC	A108	B108	VCC
VCC	A107	B107	VCC
VCC	A106	B106	VCC
VCC	A105	B105	VCC
VCC	A104	B104	VCC
LID#	A103	B103	SLEEP#
SER1_RX	A102	B102	FAN_TACHIN
SER1_TX	A101	B101	FAN_PWMOUT
GND	A100	B100	GND
SER0_RX	A99	B99	NC
SER0_TX	A98	B98	NC
TYPE10#	A97	B97	SPI_CS#
TPM_PP	A96	B96	VGA_I2C_DAT
SPI_MOSI	A95	B95	VGA_I2C_CK
SPI_CLK	A94	B94	VGA_VSYNC
GPO0	A93	B93	VGA_HSYNC
SPI_MISO	A92	B92	VGA_BLU
+3.3V_SPI	A91	B91	VGA_GRN
GND	A90	B90	GND
PCIE_CLK_REF-	A89	B89	VGA_RED
PCIE_CLK_REF+	A88	B88	BIOS_DIS1#
CB_EDP_HDP	A87	B87	+ATX5VSB
NC	A86	B86	+ATX5VSB
GPI3	A85	B85	+ATX5VSB
LVDS_I2C_DAT/EDP_AUX-	A84	B84	+ATX5VSB
LVDS_I2C_CK/EDP_AUX+	A83	B83	LVDS_BKLT_CTRL/ EDP_BKLT_CTRL
LVDS_A_CK-/EDP_TX3-	A82	B82	LVDS_B_CK-
LVDS_A_CK+/EDP_TX3+	A81	B81	LVDS_B_CK+

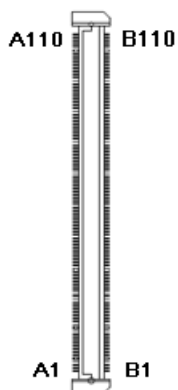
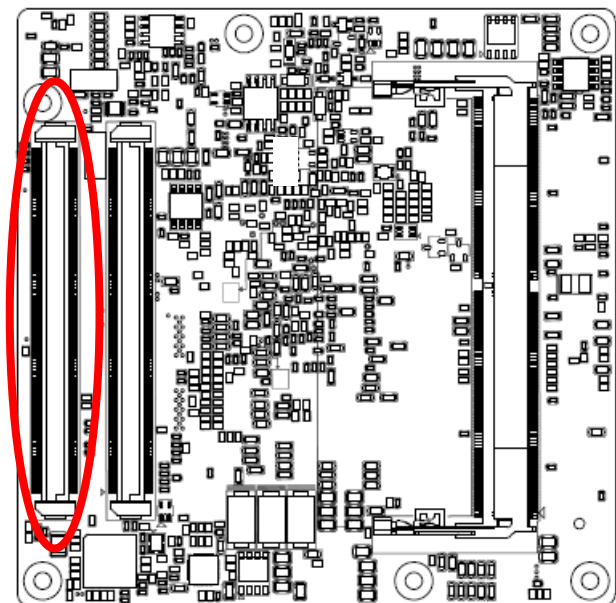

Signal	PIN	PIN	Signal
GND	A80	B80	GND
LVDS_A3-	A79	B79	LVDS_BKLT_EN/ EDP_BKLT_EN
LVDS_A3+	A78	B78	LVDS_B3-
LVDS_VDD_EN/EDP_VDD_EN	A77	B77	LVDS_B3+
LVDS_A2-/EDP_TX0-	A76	B76	LVDS_B2-
LVDS_A2+/EDP_TX0+	A75	B75	LVDS_B2+
LVDS_A1-/EDP_TX1-	A74	B74	LVDS_B1-
LVDS_A1+/EDP_TX1+	A73	B73	LVDS_B1+
LVDS_A0-/EDP_TX2-	A72	B72	LVDS_B0-
LVDS_A0+/EDP_TX2+	A71	B71	LVDS_B0+
GND	A70	B70	GND
PCIE_TX0-	A69	B69	PCIE_RX0-
PCIE_TX0+	A68	B68	PCIE_RX0+
GPI2	A67	B67	WAKE1#
GND	A66	B66	WAKE0#
PCIE_TX1-	A65	B65	PCIE_RX1-
PCIE_TX1+	A64	B64	PCIE_RX1+
GPI1	A63	B63	GPO3
PCIE_TX2-	A62	B62	PCIE_RX2-
PCIE_TX2+	A61	B61	PCIE_RX2+
GND	A60	B60	GND
PCIE_TX3-	A59	B59	PCIE_RX3-
PCIE_TX3+	A58	B58	PCIE_RX3+
GND	A57	B57	GPO2
PCIE_TX4-	A56	B56	PCIE_RX4-
PCIE_TX4+	A55	B55	PCIE_RX4+
GPI0	A54	B54	GPO1
NC	A53	B53	NC
NC	A52	B52	NC
GND	A51	B51	GND

ESM-EHLC User's Manual

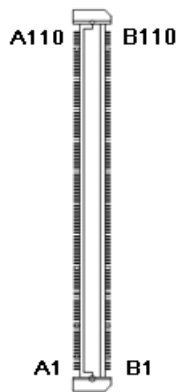
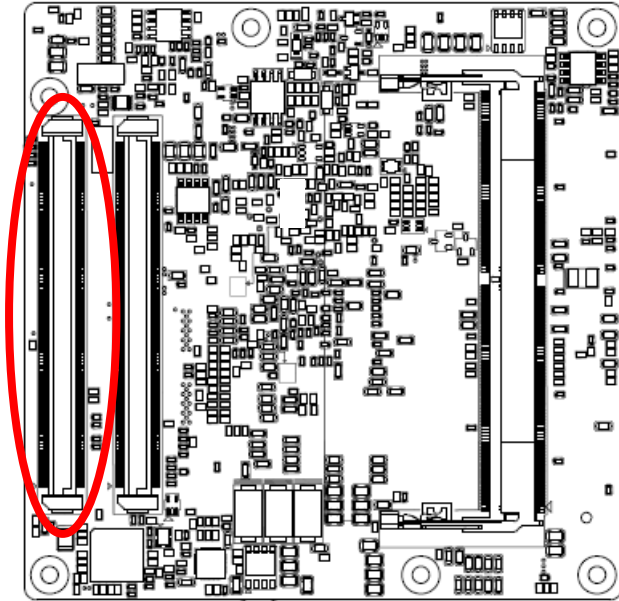

Signal	PIN	PIN	Signal
LPC_SERIRQ/ ESPI_CS1#	A50	B50	CB_RESET#
GBE0_SDP	A49	B49	SYS_RESET#
RSVD1	A48	B48	NC
+3.3V_RTC	A47	B47	NC
USB0+	A46	B46	USB1+
USB0-	A45	B45	USB1-
USB_2_3_OC#	A44	B44	USB_0_1_OC#
USB2+	A43	B43	USB3+
USB2-	A42	B42	USB3-
GND	A41	B41	GND
USB4+	A40	B40	USB5+
USB4-	A39	B39	USB5-
USB_6_7_OC#	A38	B38	USB_4_5_OC#
USB6+	A37	B37	USB7+
USB6-	A36	B36	USB7-
THRMTRIP#	A35	B35	THRM#
BIOS_DIS0#	A34	B34	I2C_DAT
HDA_SDOUT	A33	B33	I2C_CLK
HDA_BITCLK	A32	B32	SPKR
GND	A31	B31	GND
HDA_RST#	A30	B30	HDA_SDIN0
HDA_SYNC	A29	B29	HDA_SDIN1
(S)ATA_ACT#	A28	B28	NC
BATLOW#	A27	B27	WDT
NC	A26	B26	NC
NC	A25	B25	NC
SUS_S5#	A24	B24	PWR_OK
NC	A23	B23	NC
NC	A22	B22	NC
GND	A21	B21	GND

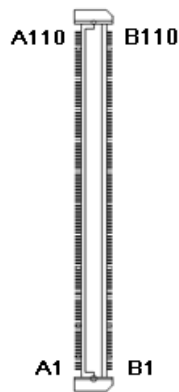
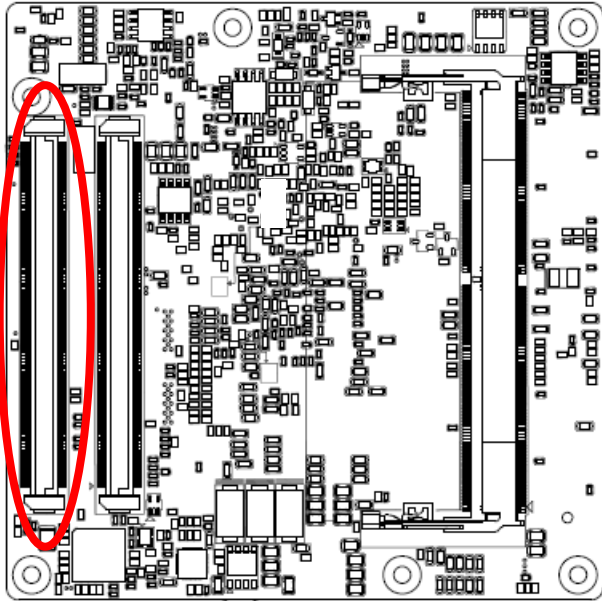

Signal	PIN	PIN	Signal
SATA0_RX-	A20	B20	SATA1_RX-
SATA0_RX+	A19	B19	SATA1_RX+
PCH_SLP_S4#	A18	B18	ESPI_RST#
SATA0_TX-	A17	B17	SATA1_TX-
SATA0_TX+	A16	B16	SATA1_TX+
SUS_S3#	A15	B15	SMB_ALERT#
GBE0_CTREF	A14	B14	SMB_SDA_S5
GBE0_MDI0+	A13	B13	SMB_SCL_S5
GBE0_MDI0-	A12	B12	PWRBTN#
GND	A11	B11	GND
GBE0_MDI1+	A10	B10	LPC_CLK/ ESPI_CK
GBE0_MDI1-	A9	B9	LPC_DRQ1#/ ESPI_ALERT1#
GBE0_LINK#	A8	B8	LPC_DRQ0#/ ESPI_ALERT0#
GBE0_MDI2+	A7	B7	LPC_AD3/ ESPI_IO_3
GBE0_MDI2-	A6	B6	LPC_AD2/ ESPI_IO_2
GBE0_LINK2500#	A5	B5	LPC_AD1/ ESPI_IO_1
GBE0_LINK100_1000#	A4	B4	LPC_AD0/ ESPI_IO_0
GBE0_MDI3+	A3	B3	LPC_FRAME#/ ESPI_CS0#
GBE0_MDI3-	A2	B2	GBE0_ACT#
GND	A1	B1	GND

2.3.2.1 Signal Description – COM Express Connector 1 (CN1A)

2.3.2.1.1 Audio Signals

Signal	Signal Description
HDA_SYNC	HD Audio Sync
HDA_RST#	HD Audio Reset

2.3.2.1.2 Gigabit Ethernet Signals

Signal	Signal Description																				
GBE0_MD[0:3] +/-	Gigabit Ethernet Controller 0: Media Dependent Interface Differential Pairs 0,1,2,3. The MDI can operate in 2500, 1000, 100 and 10 Mbit / sec modes. Some pairs are unused in some modes, per the following:																				
	<table border="1"> <thead> <tr> <th></th> <th>2500B-T/1000B-T</th> <th>100B-T</th> <th>10B-T</th> </tr> </thead> <tbody> <tr> <td>MDI[0] +/-</td> <td>B1_DA+</td> <td>TX +/-</td> <td>TX +/-</td> </tr> <tr> <td>MDI[1] +/-</td> <td>B1_DB+</td> <td>RX +/-</td> <td>RX +/-</td> </tr> <tr> <td>MDI[2] +/-</td> <td>B1_DC+</td> <td>X</td> <td>X</td> </tr> <tr> <td>MDI[3] +/-</td> <td>B1_DD+</td> <td>X</td> <td>X</td> </tr> </tbody> </table>		2500B-T/1000B-T	100B-T	10B-T	MDI[0] +/-	B1_DA+	TX +/-	TX +/-	MDI[1] +/-	B1_DB+	RX +/-	RX +/-	MDI[2] +/-	B1_DC+	X	X	MDI[3] +/-	B1_DD+	X	X
		2500B-T/1000B-T	100B-T	10B-T																	
	MDI[0] +/-	B1_DA+	TX +/-	TX +/-																	
	MDI[1] +/-	B1_DB+	RX +/-	RX +/-																	
MDI[2] +/-	B1_DC+	X	X																		
MDI[3] +/-	B1_DD+	X	X																		
GBE0_ACT#	Gigabit Ethernet Controller 0 activity indicator, active low.																				
GBE0_LINK#	Gigabit Ethernet Controller 0 link indicator, active low.																				
GBE0_LINK100_1000#	Gigabit Ethernet Controller 100 1000 Mbit / sec link indicator, active low.																				
GBE0_LINK2500#	Gigabit Ethernet Controller 2500 Mbit / sec link indicator, active low.																				

2.3.2.1.3 PCI Express Signals

Signal	Signal Description
PCIE_TX[0:4] +/-	PCI Express Differential Transmit Pair 0-4
PCIE_RX[0:4] +/-	PCI Express Differential Receive Pair 0-4

2.3.2.1.4 Flat Panel LVDS Signals

Signal	Signal Description
LVDS_BKLT_CTRL	Controls panel digital power.
LVDS_I2C_CLK	I2C clock output for LVDS display use.
LVDS_I2C_DAT	I2C data line for LVDS display use.
LVDS_VDD_EN	LVDS panel power enables.

2.3.2.1.5 LPC/eSPI Signals

Signal	Signal Description
LPC_FRAME#/ ESPI_CS0#	LPC frame indicates the start of an LPC cycle ESPI Mode: eSPI Master Chip Select Outputs Driving Chip Select0#. A low selects a particular eSPI slave for the transaction. Each of the eSPI slaves is connected to a dedicated Chip Selectn# pin
LPC_AD[0:3]/ ESPI_IO_[0:3]	LPC multiplexed address, command and data bus ESPI Mode: eSPI Master Data Input / Outputs These are bi-directional input/output pins used to transfer data between master and slaves. Multiplexed with LPC_AD[0:3]
LPC_CLK/ ESPI_CK	LPC clock output - 33MHz nominal ESPI Mode: eSPI Master Clock Output This pin provides the reference timing for all the serial input and output operations
LPC_SERIRQ/ ESPI_CS1#	LPC serial interrupt ESPI Mode: eSPI Master Chip Select Outputs Driving Chip Select# A low selects a particular eSPI slave for the transaction. Each of the eSPI slaves is connected to a dedicated Chip Selectn# pin
LPC_DRQ0#/ ESPI_ALERT0#	LPC serial DMA request. ESPI Mode: eSPI pins used by eSPI slave to request service from the eSPI master.
LPC_DRQ1#/ ESPI_ALERT1#	LPC serial DMA request. ESPI Mode: eSPI pins used by eSPI slave to request service from the eSPI master.

2.3.2.1.6 GPIO Signals

Signal	Signal Description
GPI[0:4]	General purpose input pins.
GPO[0:4]	General purpose output pins.

2.3.2.1.7 Power & System Management Signals

Signal	Signal Description
SUS_S3#	Indicates system is in Suspend to RAM state. Active low output.
BATLOW#	Indicates that external battery is low
PWRBTN#	Power button to bring system out of S5 (soft off), active on rising edge.

ESM-EHLC User's Manual

SMB_SCL_S5	System Management Bus bidirectional clock line.
SMB_SDA_S5	System Management Bus bidirectional data line.
SMB_ALERT#	System Management Bus Alert - input can be used to generate an SMI# (System Management Interrupt) or to wake the system.
ESPI_RST#	ESPI Mode: eSPI Reset Reset the eSPI interface for both master and slaves. eSPI Reset# is typically driven from eSPI master to eSPI slaves
PWR_OK	Power OK from main power supply
SYS_RESET#	Reset button input. Active low input.
WAKE0#	PCI Express wake up signal.
WAKE1#	General purpose wake up signal.

2.3.2.1.8 SATA Signals

Signal	Signal Description
SATA[0:1]_TX +/-	Serial ATA Channel 0-1 transmit differential pair.
SATA[0:1]_RX +/-	Serial ATA Channel 0-1 receive differential pair.
ATA_ACT#	ATA (parallel and serial) activity indicator, active low.

2.3.2.1.9 USB Signals

Signal	Signal Description
USB[0:7] +/-	USB differential pairs, channels 0 through 7
USB_0_1_OC#	USB over-current sense, USB channels 0 and 1
USB_2_3_OC#	USB over-current sense, USB channels 2 and 3
USB_4_5_OC#	USB over-current sense, USB channels 4 and 5
USB_6_7_OC#	USB over-current sense, USB channels 6 and 7

2.3.2.1.10 I2C Signals

Signal	Signal Description
I2C_CLK	General purpose I2C port clock output.
I2C_DATA	General purpose I2C port data I/O line.

2.3.2.1.11 USB3.0 Signals

Signal	Signal Description
USB_SSTX[0:1]+ USB_SSTX[0:1]-	Additional transmit signal differential pairs for the SuperSpeed USB data path.
USB_SSRX[0:1]+ USB_SSRX[0:1]-	Additional receive signal differential pairs for the SuperSpeed USB data path.

ESM-EHLC User's Manual

2.3.3 COM Express Connector 2 (CN1B)

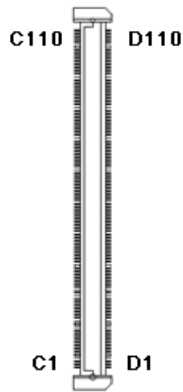
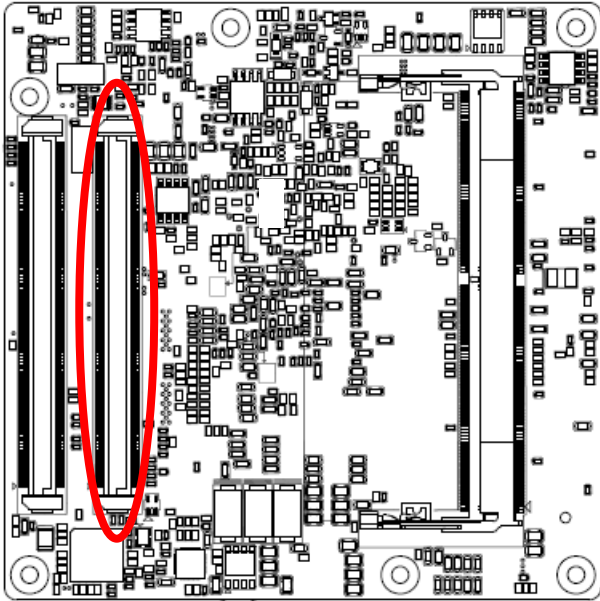

Signal	PIN	PIN	Signal
GND	C110	D110	GND
VCC	C109	D109	VCC
VCC	C108	D108	VCC
VCC	C107	D107	VCC
VCC	C106	D106	VCC
VCC	C105	D105	VCC
VCC	C104	D104	VCC
GND	C103	D103	GND
NC	C102	D102	NC
NC	C101	D101	NC
GND	C100	D100	GND
NC	C99	D99	NC
NC	C98	D98	NC
NC	C97	D97	NC
GND	C96	D96	GND
NC	C95	D95	NC
NC	C94	D94	NC
GND	C93	D93	GND
NC	C92	D92	NC
NC	C91	D91	NC
GND	C90	D90	GND
NC	C89	D89	NC
NC	C88	D88	NC
GND	C87	D87	GND
NC	C86	D86	NC
NC	C85	D85	NC
GND	C84	D84	GND
NC	C83	D83	NC
NC	C82	D82	NC
NC	C81	D81	NC

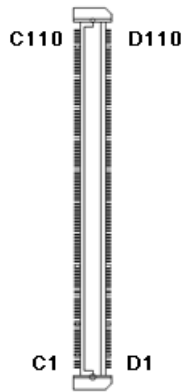
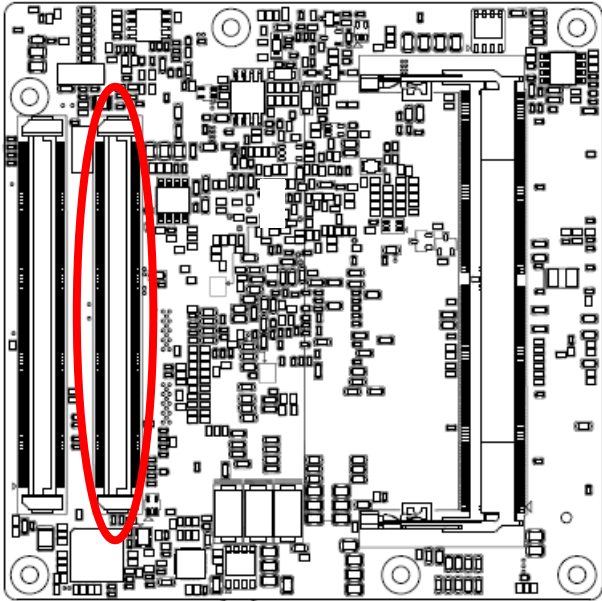

Signal	PIN	PIN	Signal
GND	C80	D80	GND
NC	C79	D79	NC
NC	C78	D78	NC
NC	C77	D77	NC
GND	C76	D76	GND
NC	C75	D75	NC
NC	C74	D74	NC
GND	C73	D73	GND
NC	C72	D72	NC
NC	C71	D71	NC
GND	C70	D70	GND
NC	C69	D69	NC
NC	C68	D68	NC
RAPID_SHUTDOWN	C67	D67	GND
NC	C66	D66	NC
NC	C65	D65	NC
NC	C64	D64	NC
NC	C63	D63	NC
NC	C62	D62	NC
NC	C61	D61	NC
GND	C60	D60	GND
NC	C59	D59	NC
NC	C58	D58	NC
TYPE1#	C57	D57	TYPE2#
NC	C56	D56	NC
NC	C55	D55	NC
TYPE0#	C54	D54	NC
NC	C53	D53	NC
NC	C52	D52	NC
GND	C51	D51	GND

ESM-EHLC User's Manual

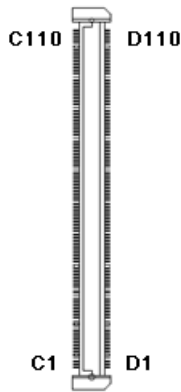
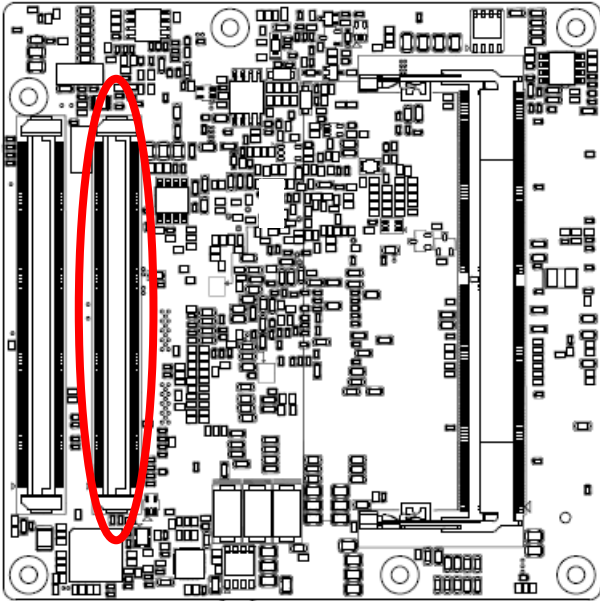

Signal	PIN	PIN	Signal
DDI3_PAIR3-	C50	D50	DDI2_PAIR3-
DDI3_PAIR3+	C49	D49	DDI2_PAIR3+
NC	C48	D48	NC
DDI3_PAIR2-	C47	D47	DDI2_PAIR2-
DDI3_PAIR2+	C46	D46	DDI2_PAIR2+
NC	C45	D45	NC
DDI3_HPDP	C44	D44	DDI2_HPDP
DDI3_PAIR1-	C43	D43	DDI2_PAIR1-
DDI3_PAIR1+	C42	D42	DDI2_PAIR1+
GND	C41	D41	GND
DDI3_PAIR0-	C40	D40	DDI2_PAIR0-
DDI3_PAIR0+	C39	D39	DDI2_PAIR0+
DDI3_DDC_AUX_SEL	C38	D38	NC
DDI3_CTRLDATA_AUX-	C37	D37	DDI1_PAIR3-
DDI3_CTRLCLK_AUX+	C36	D36	DDI1_PAIR3+
NC	C35	D35	NC
DDI2_DDC_AUX_SEL	C34	D34	DDI1_DDC_AUX_SEL
DDI2_CTRLDATA_AUX-	C33	D33	DDI1_PAIR2-
DDI2_CTRLCLK_AUX+	C32	D32	DDI1_PAIR2+
GND	C31	D31	GND
NC	C30	D30	DDI1_PAIR1-
NC	C29	D29	DDI1_PAIR1+
NC	C28	D28	NC
NC	C27	D27	DDI1_PAIR0-
NC	C26	D26	DDI1_PAIR0+
NC	C25	D25	NC
DDI1_HPDP	C24	D24	NC
NC	C23	D23	NC
NC	C22	D22	NC
GND	C21	D21	GND

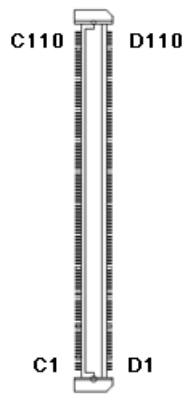
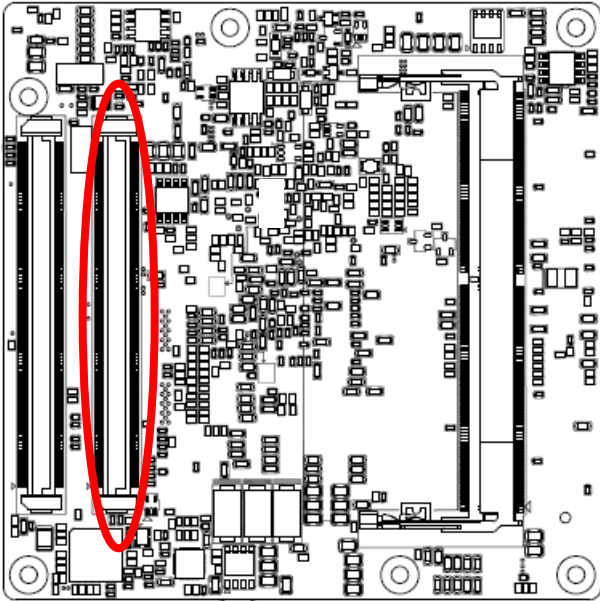

Signal	PIN	PIN	Signal
NC	C20	D20	NC
NC	C19	D19	NC
LVDS_BLDN	C18	D18	NC
LVDS_BLUP	C17	D17	NC
NC	C16	D16	DDI1_CTRLCLK_AUX-
NC	C15	D15	DDI1_CTRLCLK_AUX+
GND	C14	D14	GND
USB_SSRX3+	C13	D13	USB_SSTX3+
USB_SSRX3-	C12	D12	USB_SSTX3-
GND	C11	D11	GND
USB_SSRX2+	C10	D10	USB_SSTX2+
USB_SSRX2-	C9	D9	USB_SSTX2-
GND	C8	D8	GND
USB_SSRX1+	C7	D7	USB_SSTX1+
USB_SSRX1-	C6	D6	USB_SSTX1-
GND	C5	D5	GND
USB_SSRX0+	C4	D4	USB_SSTX0+
USB_SSRX0-	C3	D3	USB_SSTX0-
GND	C2	D2	GND
GND	C1	D1	GND

ESM-EHLC User's Manual

2.3.3.1 Signal Description – COM Express Connector 2 (CN1B)

2.3.3.1.1 USB3.0 Signals

Signal	Signal Description
USB_SSTX[0:3]+ USB_SSTX[0:3]-	Additional transmit signal differential pairs for the SuperSpeed USB data path.
USB_SSRX[0:3]+ USB_SSRX[0:3]-	Additional receive signal differential pairs for the SuperSpeed USB data path.

2.3.3.1.2 DDI Signals

Signal	Signal Description
DDI[1:3]_PAIR[0:3]+ DDI[1:3]_PAIR[0:3]-	Digital Display Interface 1 to 3Pair[0:3] differential pairs
DDI[1:3]_DDC_AUX_SEL	Selects the function of DDI[1:3]_CTRLCLK_AUX+ and DDI[1:3]_CTRLDATA_AUX-. If this input is floating the AUX pair is used for the DP AUX+/- signals. If pulled-high the AUX pair contains the CTRLCLK and CTRLDATA signals.
DDI[1:3]_CTRLCLK_AUX+	DP AUX+function if DDI[1:3]_DDC_AUX_SEL is no connect HDMI/DVI 12C CTRLCLK if DDI[1:3]_DDC_AUX_SEL is pulled high
DDI[1:3]_CTRLDATA_AUX-	DP AUX-function if DDI[1:3]_DDC_AUX_SEL is no connect HDMI/DVI 12C CTRLDATA if DDI[1:3]_DDC_AUX_SEL is pulled high
DDI[1:3]_HPD	Digital Display Interface Hot-Plug Detect

2.4 Installing Heatsink / Heat spreader

Standard Temperature

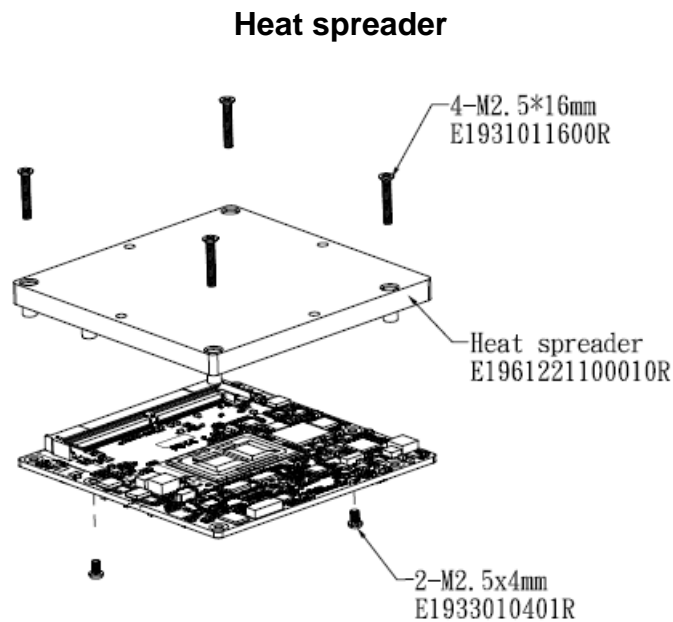
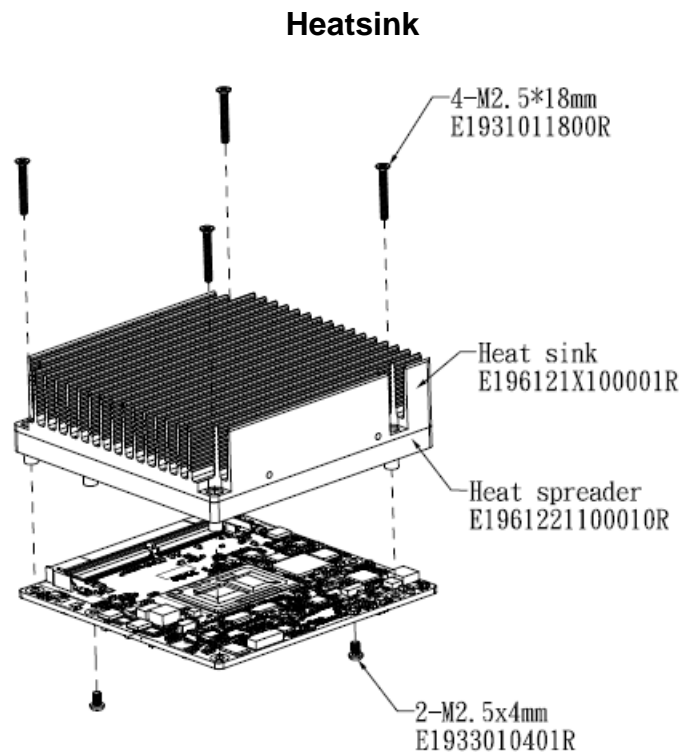

Step1. Using 4 screws (M2.5-16L) to lock the Heatsink/Heat spreader from PCB backside.

Note:

Screw Size/Q'TY

- M2.5-16L Ni*4pcs

Wide Temperature

Heat spreader

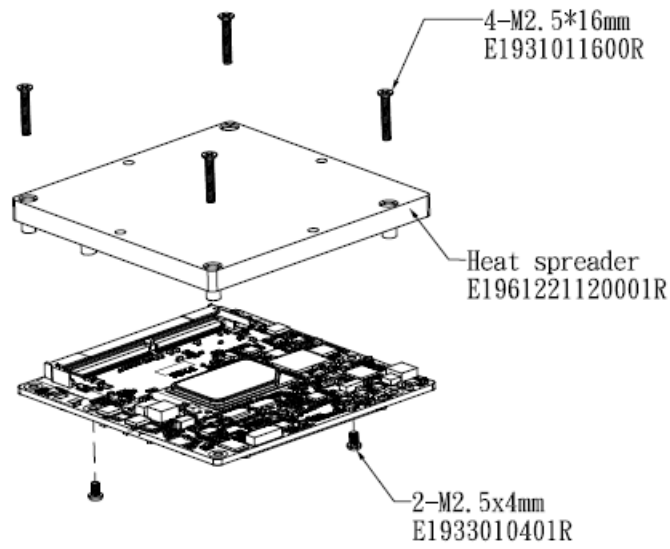

Cooler

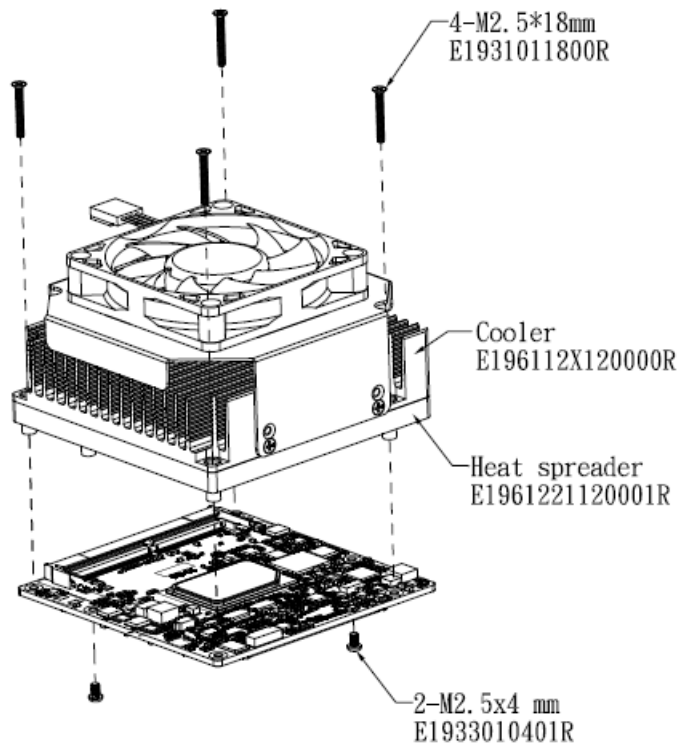

Step1. Using 4 screws (M2.5-12L) to lock the Heat spreader/Cooler from PCB backside.

Note:

Screw Size/Q'TY

- M2.5-12L Ni*4pcs

3. BIOS Setup

3.1 Introduction

The BIOS setup program allows users to modify the basic system configuration. In this following chapter will describe how to access the BIOS setup program and the configuration options that may be changed.

3.2 Starting Setup

AMI BIOS™ is immediately activated when you first power on the computer. The BIOS reads the system information contained in the NVRAM and begins the process of checking out the system and configuring it. When it finishes, the BIOS will seek an operating system on one of the disks and then launch and turn control over to the operating system.

While the BIOS is in control, the Setup program can be activated in one of two ways:

By pressing <F2> or immediately after switching the system on, or

By pressing the <F2> or key when the following message appears briefly at the left-top of the screen during the POST (Power On Self Test).

Press <F2> or to enter SETUP

If the message disappears before you respond and you still wish to enter Setup, restart the system to try again by turning it OFF then ON or pressing the "RESET" button on the system case. You may also restart by simultaneously pressing <Ctrl>, <Alt>, and <Delete> keys.

3.3 Using Setup

In general, you use the arrow keys to highlight items, press <Enter> to select, use the PageUp and PageDown keys to change entries, press <F1> for help and press <Esc> to quit. The following table provides more detail about how to navigate in the Setup program using the keyboard.

Button	Description
↑	Move to previous item
↓	Move to next item
←	Move to the item in the left hand
→	Move to the item in the right hand
Esc key	Main Menu -- Quit and not save changes into NVRAM Status Page Setup Menu and Option Page Setup Menu -- Exit current page and return to Main Menu
+ key	Increase the numeric value or make changes
- key	Decrease the numeric value or make changes
F1 key	General help, only for Status Page Setup Menu and Option Page Setup Menu
F2 key	Previous Values
F3 key	Optimized defaults
F4 key	Save & Exit Setup

- **Navigating Through The Menu Bar**

Use the left and right arrow keys to choose the menu you want to be in.



Note: Some of the navigation keys differ from one screen to another.

- **To Display a Sub Menu**

Use the arrow keys to move the cursor to the sub menu you want. Then press <Enter>. A “➤” pointer marks all sub menus.

3.4 Getting Help

Press F1 to pop up a small help window that describes the appropriate keys to use and the possible selections for the highlighted item. To exit the Help Window press <Esc> or the F1 key again.

3.5 In Case of Problems

If, after making and saving system changes with Setup, you discover that your computer no longer is able to boot, the BIOS supports an override to the NVRAM settings which resets your system to its defaults.

The best advice is to only alter settings which you thoroughly understand. To this end, we strongly recommend that you avoid making any changes to the chipset defaults. These defaults have been carefully chosen by both your systems manufacturer to provide the absolute maximum performance and reliability. Even a seemingly small change to the chipset setup has the potential for causing you to use the override.

3.6 BIOS setup

Once you enter the Aptio Setup Utility, the Main Menu will appear on the screen. The Main Menu allows you to select from several setup functions and exit choices. Use the arrow keys to select among the items and press <Enter> to accept and enter the sub-menu.

3.6.1 Main Menu

This section allows you to record some basic hardware configurations in your computer and set the system clock.

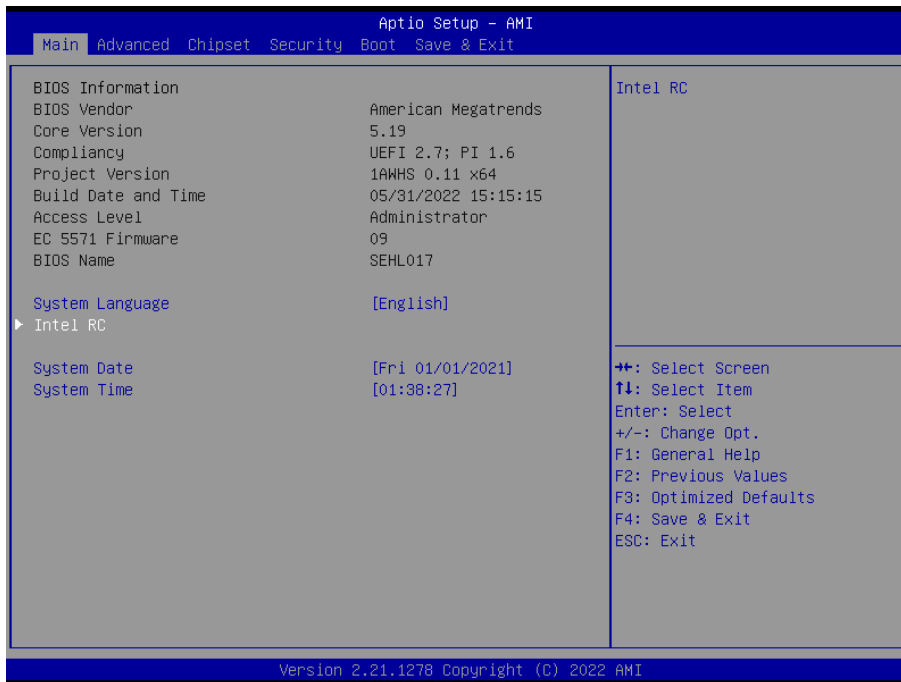

ESM-EHLC User's Manual

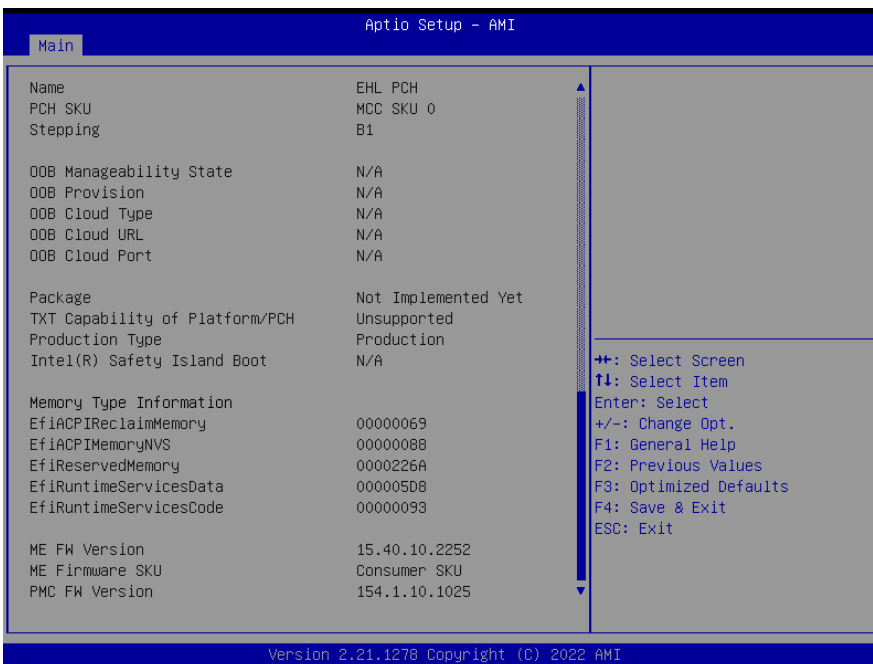
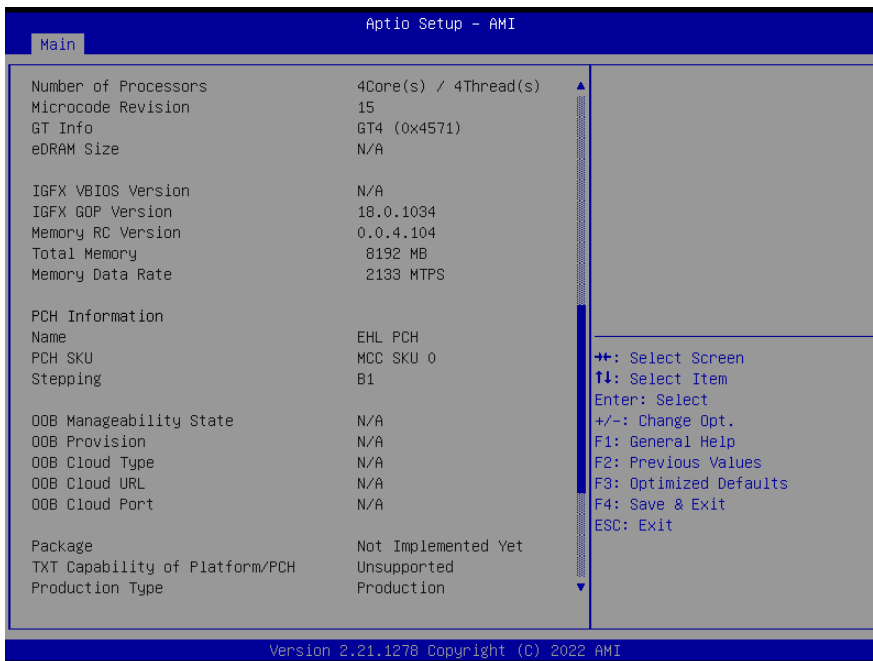

3.6.1.1 System Language

This option allows choosing the system default language.

3.6.1.2 System Date

Use the system date option to set the system date. Manually enter the day, month and year.

3.6.1.3 System Time

Use the system time option to set the system time. Manually enter the hours, minutes and seconds.



Note: The BIOS setup screens shown in this chapter are for reference purposes only, and may not exactly match what you see on your screen.

Visit the Avalue website (www.avalue.com.tw) to download the latest product and BIOS information.

3.6.2 Advanced Menu

This section allows you to configure your CPU and other system devices for basic operation through the following sub-menus.

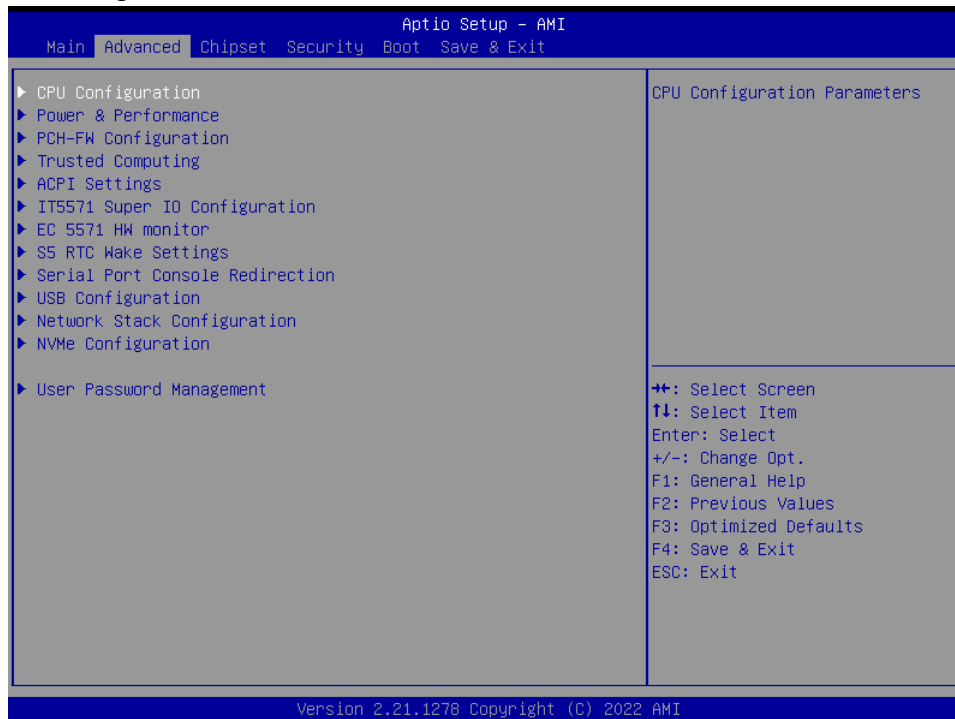

ESM-EHLC User's Manual

3.6.2.1 CPU Configuration

Use the CPU configuration menu to view detailed CPU specification and configure the CPU.

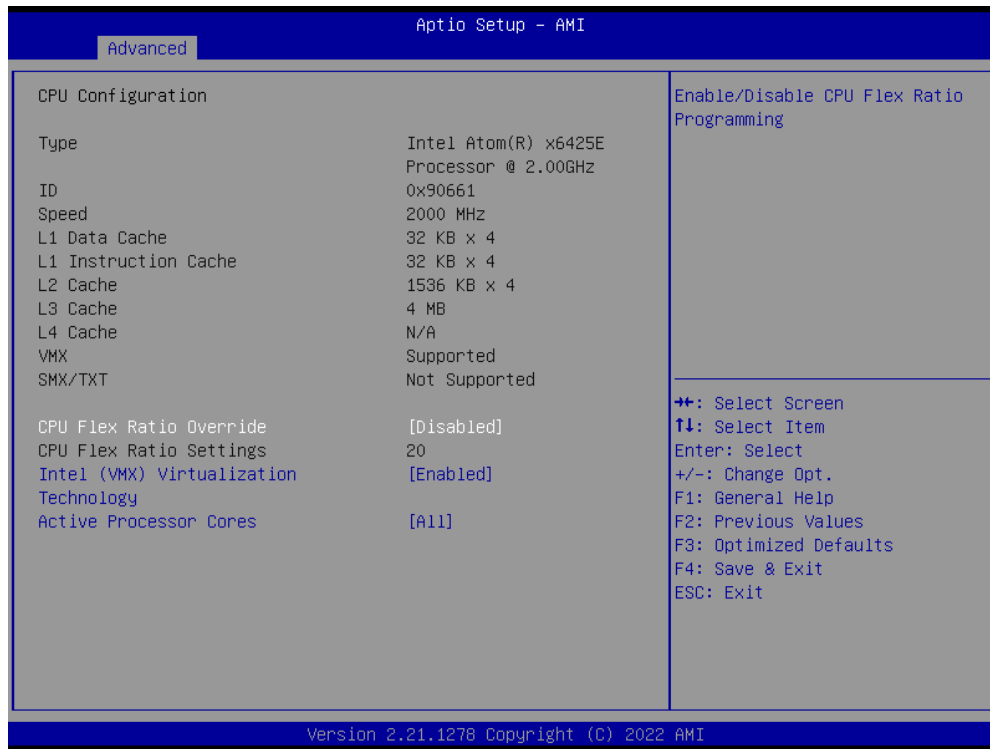

Item	Options	Description
CPU Flex Ratio Override	Disabled[Default] Enabled	Enable/Disable CPU Flex Ratio Programming.
Intel (VMX) Virtualization Technology	Disabled Enabled[Default]	When enabled, a VMM can utilize the additional hardware capabilities provided by Vanderpool Technology.
Active Processor Cores	All[Default] 1 2 3 4 5 6 7 8	Number of cores to enable in each processor package.

3.6.2.2 Power & Performance

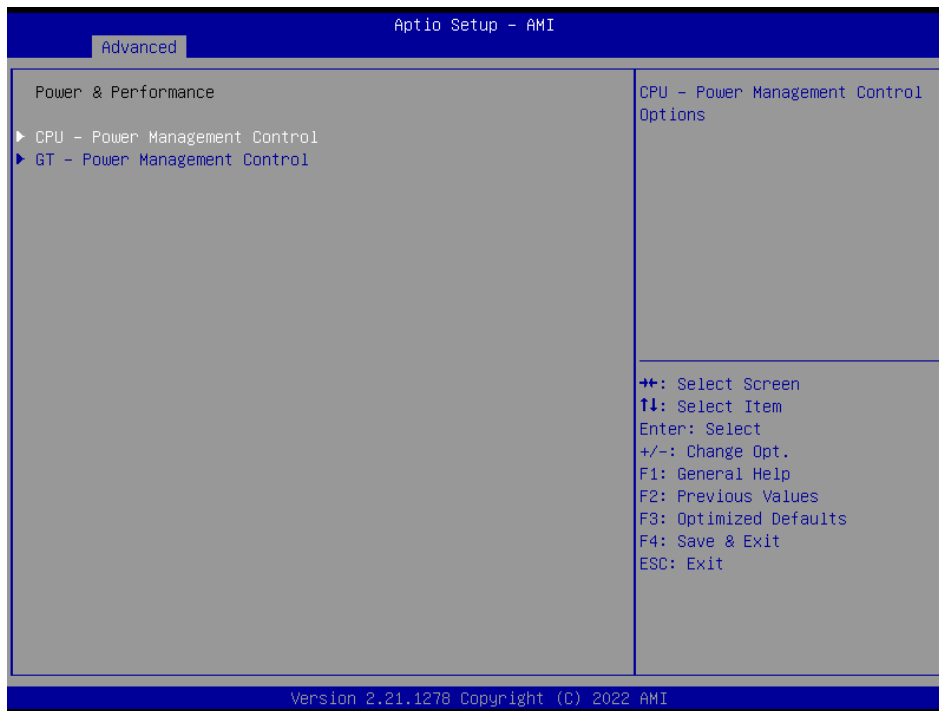

3.6.2.2.1 CPU – Power Management Control

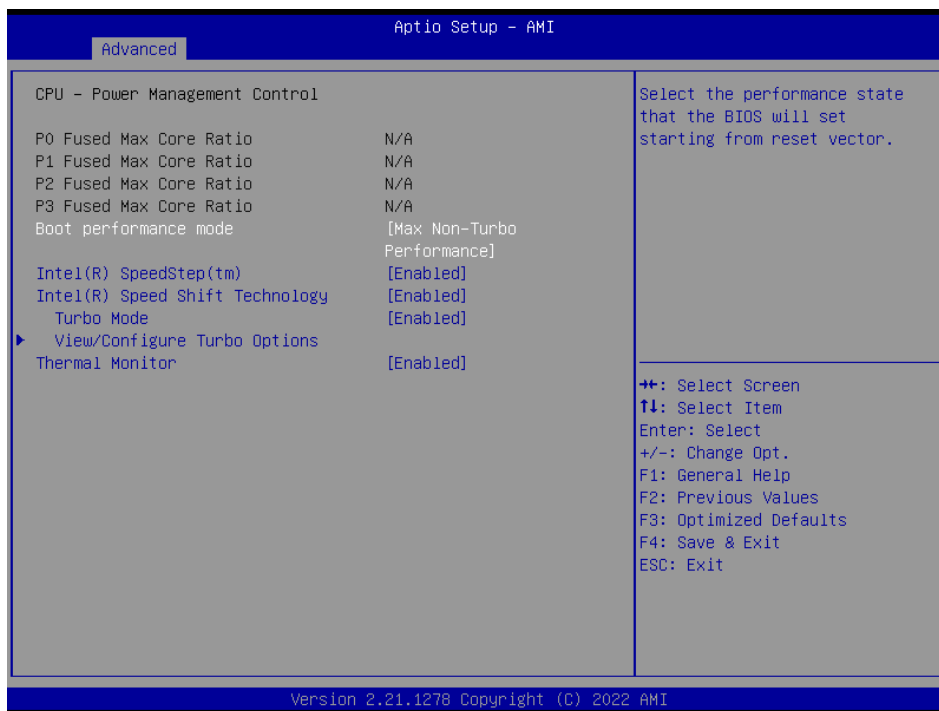

Item	Option	Description
Boot performance mode	Max Battery Max Non-Turbo Performance[Default] Turbo Performance	Select the performance state that the BIOS will set starting from reset vector.
Intel® SpeedStep™	Enabled[Default], Disabled	Allows more than two frequency ranges to be supported.

ESM-EHLC User's Manual

Intel® Speed Shift Technology	Enabled[Default], Disabled	Enable/Disable Intel® Speed Shift Technology support. Enabling will expose the CPPC v2 interface to allow for hardware controlled P-states.
Turbo Mode	Enabled[Default], Disabled	Enable/Disable processor Turbo Mode (requires Intel Speed Step or Intel Speed Shift to be available and enabled).
Thermal Monitor	Enabled[Default], Disabled	Enable/Disable Thermal Monitor.

3.6.2.2.1.1 View/Configure Turbo Options

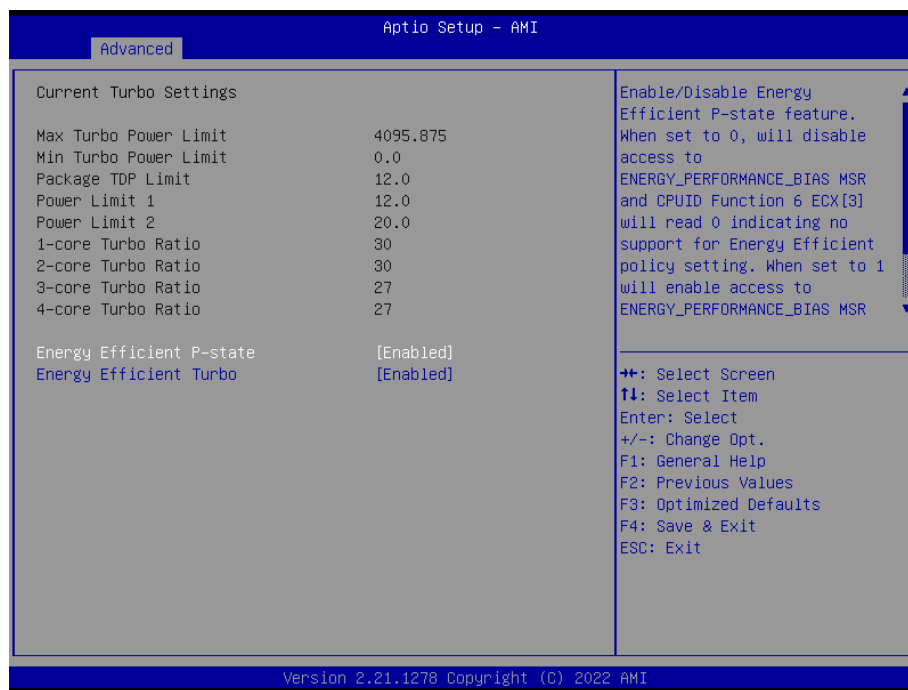

Item	Option	Description
Energy Efficient P-state	Enabled[Default], Disabled	Enable/Disable Energy Efficient P-state feature. When set to 0, will disable access to ENERGY_PERFORMANCE_BIAS MSR and CPUID Function 6 EXC[3] will read 0 indicating no support for Energy Efficient policy setting. When set to 1 will enable access to ENERGY_PERFORMANCE_BIAS MSR 0B0h.
Energy Efficient Turbo	Enabled[Default], Disabled	Enable/Disable Energy Efficient Turbo Feature. This feature will opportunistically lower the turbo frequency to increase efficiency. Recommended only to disable in overclocking situations where turbo frequency must remain constant. Otherwise, leave enabled.

3.6.2.2.2 GT – Power Management Control

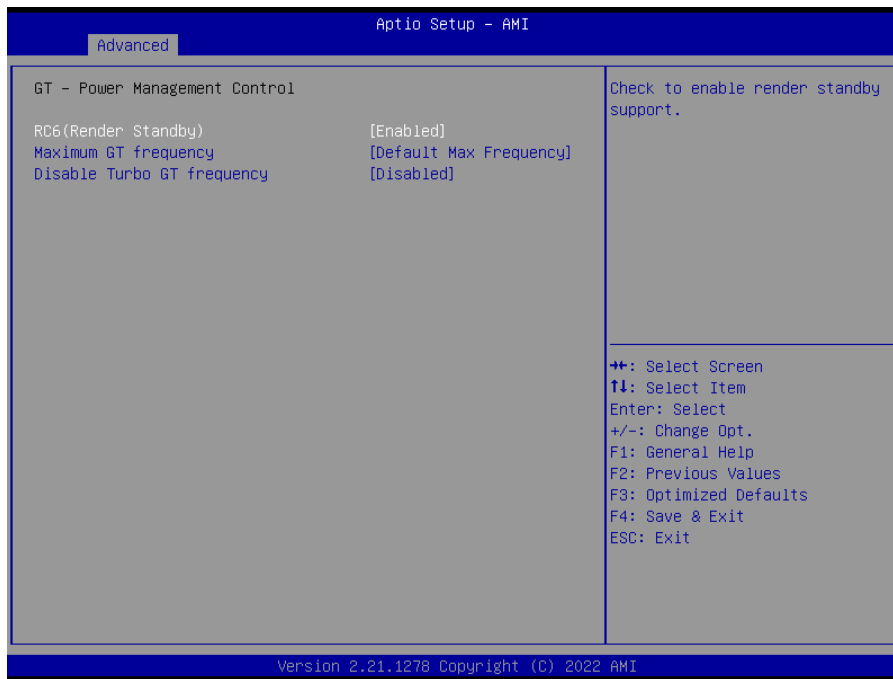

Item	Option	Description
RC6(Render Standby)	Enabled[Default], Disabled	Check to enable render standby support.
Maximum GT frequency	Default Max Frequency[Default],/ 100Mhz/150Mhz/200Mhz/250Mhz/ 300Mhz/350Mhz/400Mhz/450Mhz/ 500Mhz/550Mhz/600Mhz/650Mhz/ 700Mhz/750Mhz/800Mhz/850Mhz/ 900Mhz/950Mhz/1000Mhz/1050Mhz/ 1100Mhz/1150Mhz/1200Mhz	Auto Updated.
Disable Turbo GT frequency	Enabled Disabled[Default]	Enable: Disables Turbo GT frequency. Disabled: GT frequency is not limited.

3.6.2.3 PCH-FW Configuration

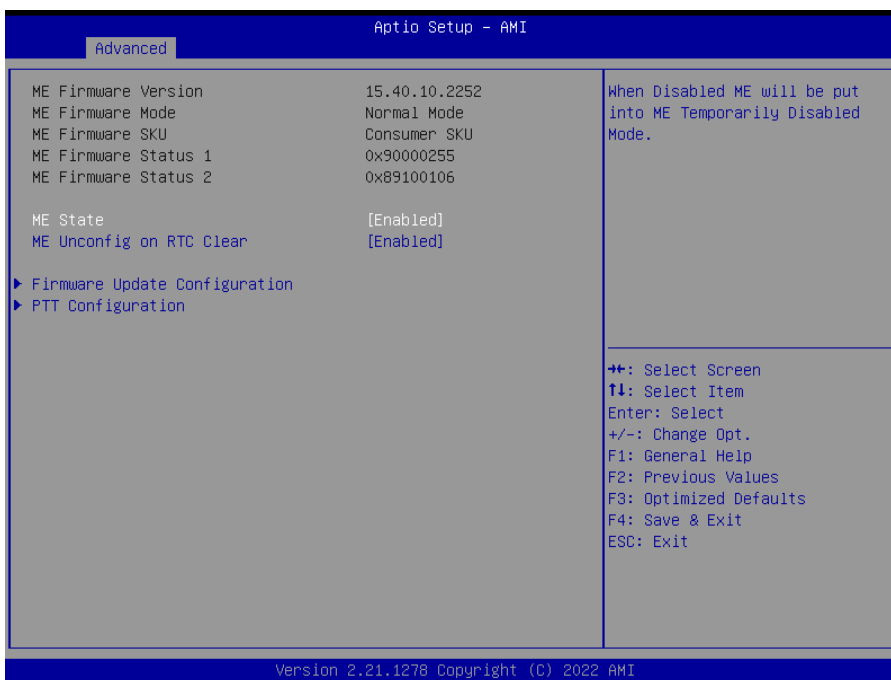

Item	Option	Description
ME State	Disabled Enabled[Default],	When Disabled ME will be put into ME Temporarily Disabled Mode.
ME Unconfig on RTC Clear	Disabled Enabled[Default],	When Disabled ME will not be unconfigured on RTC Clear.

3.6.2.3.1 Firmware Update Configuration



Item	Option	Description
ME FW Image Re-Flash	Disabled[Default], Enabled	Enable/Disable Me FW Image Re-Flash function.
FW Update	Disabled Enabled[Default],	Enable/Disable Me FW Update function.

3.6.2.3.2 PTT Configuration

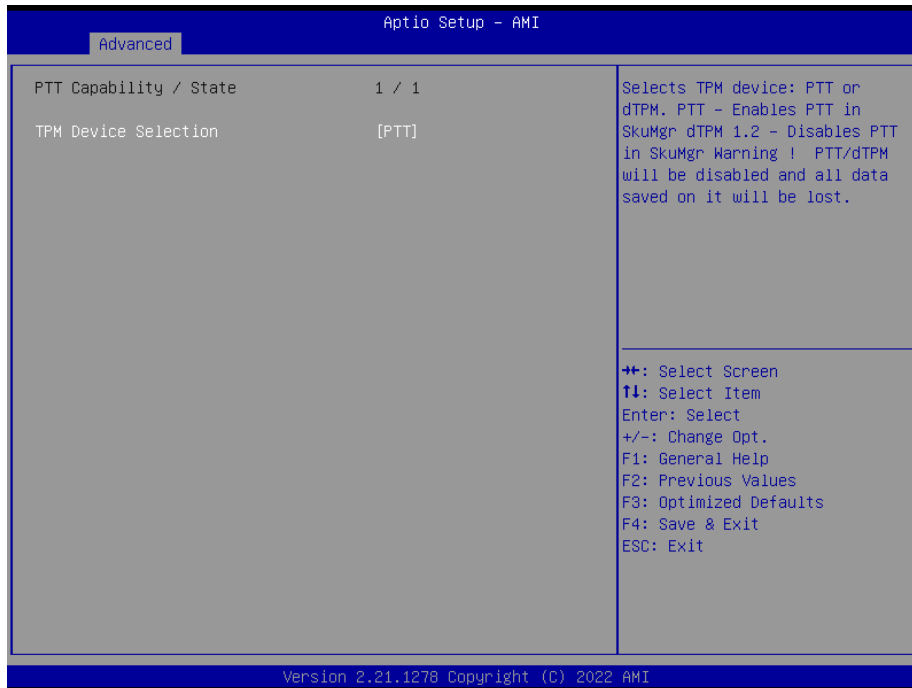

Item	Option	Description
TPM Device Selection	dTPM, PTT[Default]	Selects TPM device: PTT or dTPM. PTT-Enables PTT in SkuMgr dTPM 1.2 – Disables PTT in SkuMgr Warning! PTT/dTPM will be disabled and all data saved on it will be lost.

3.6.2.4 Trusted Computing

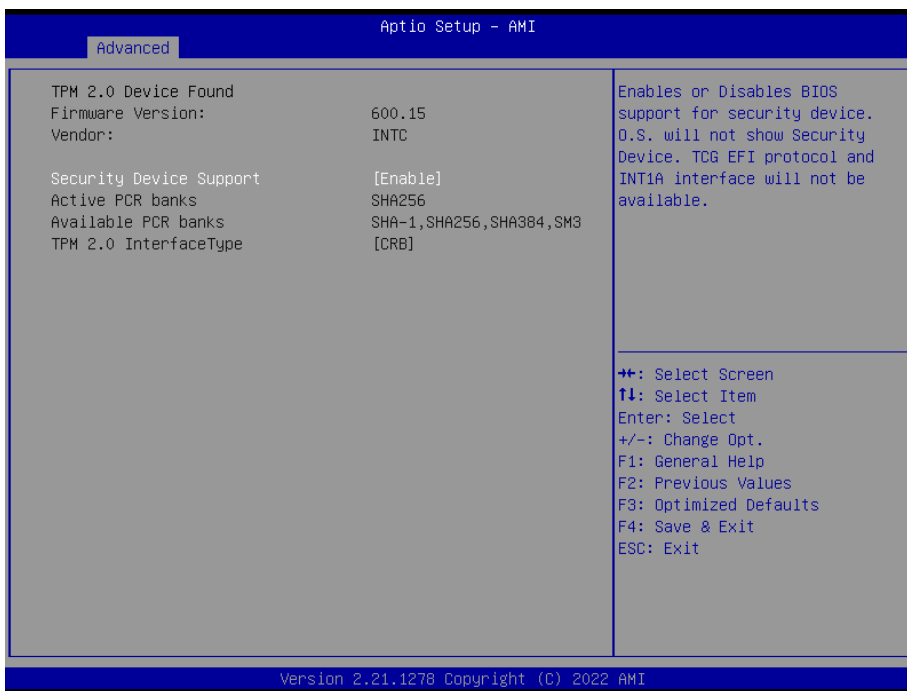

Item	Options	Description
Security Device Support	Disable, Enable[Default]	Enables or Disables BIOS support for security device. O.S. will not show Security Device. TCG EFI protocol and INT1A interface will not be available.

3.6.2.5 APCI Settings

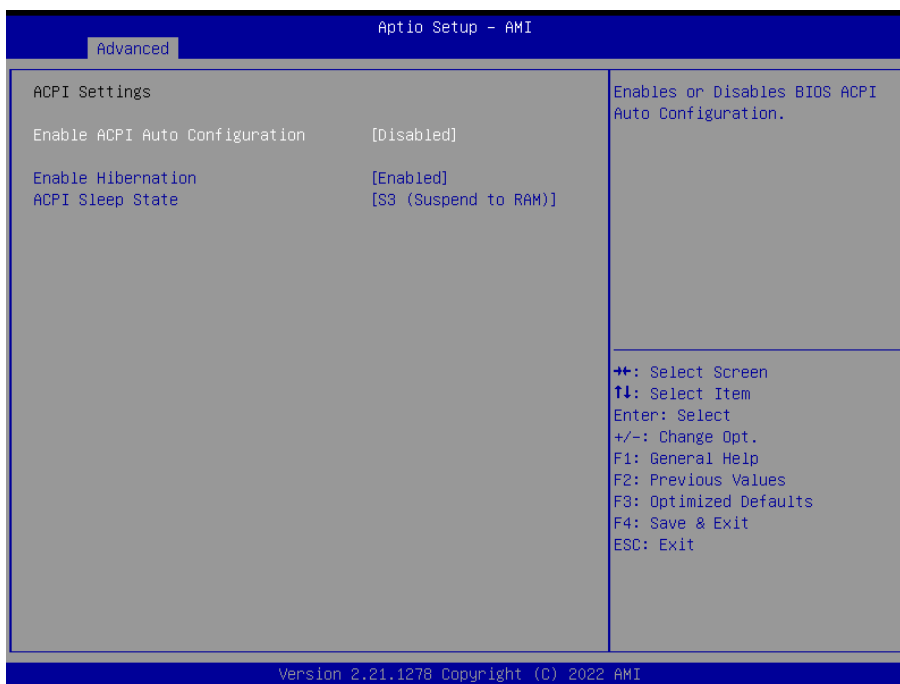

Item	Options	Description
Enable ACPI Auto Configuration	Disabled[Default] Enabled,	Enables or Disables BIOS ACPI Auto Configuration.
Enable Hibernation	Disabled Enabled[Default],	Enables or Disables System ability to Hibernate (OS/S4 Sleep State). This option may not be effective with some OS.
ACPI Sleep State	Suspend Disabled, S3 (Suspend to RAM)[Default]	Select the highest ACPI sleep state the system will enter when the SUSPEND button is pressed.

3.6.2.6 IT5571 Super IO Configuration

You can use this item to set up or change the IT5571 Super IO configuration for serial ports. Please refer to 3.6.2.6.1 ~ 3.6.2.6.2 for more information.

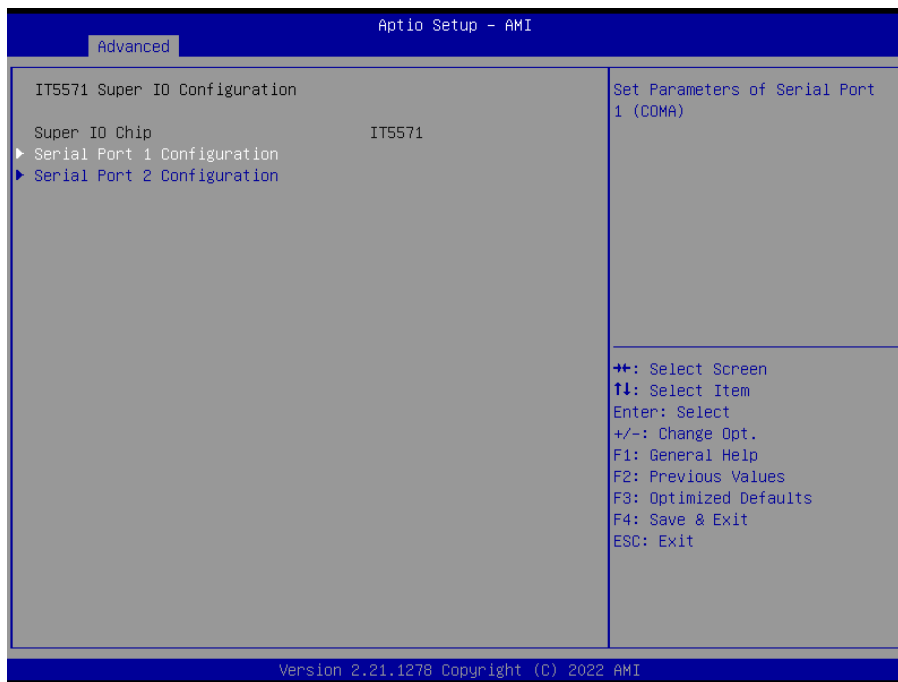

Item	Description
Serial Port 1 Configuration	Set Parameters of Serial Port 1 (COMA).
Serial Port 2 Configuration	Set Parameters of Serial Port 2 (COMB).

3.6.2.6.1 Serial Port 1 Configuration

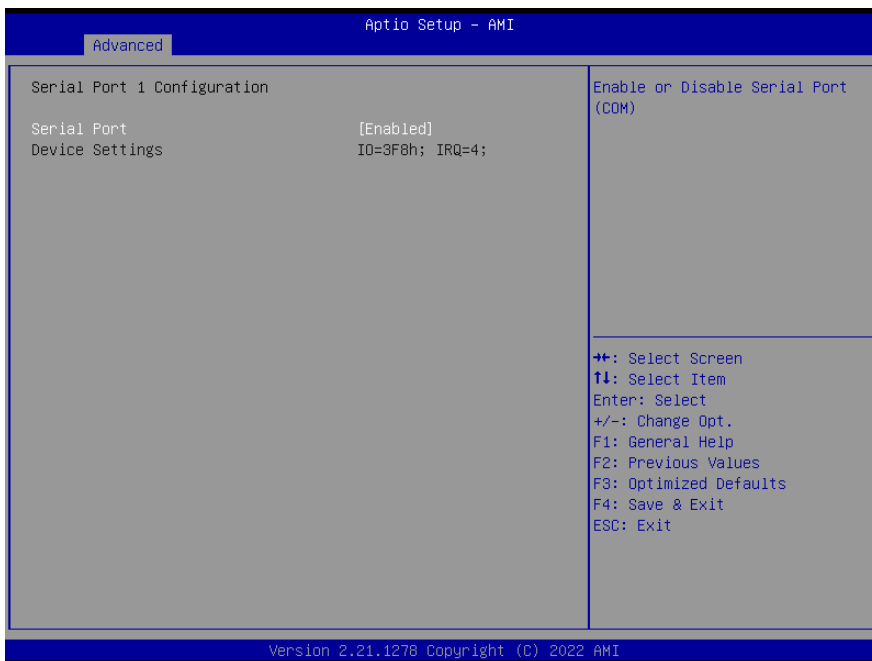

Item	Option	Description
Serial Port	Enabled[Default], Disabled	Enable or Disable Serial Port (COM).

3.6.2.6.2 Serial Port 2 Configuration



Item	Option	Description
Serial Port	Enabled[Default], Disabled	Enable or Disable Serial Port (COM).

3.6.2.7 HW Monitor

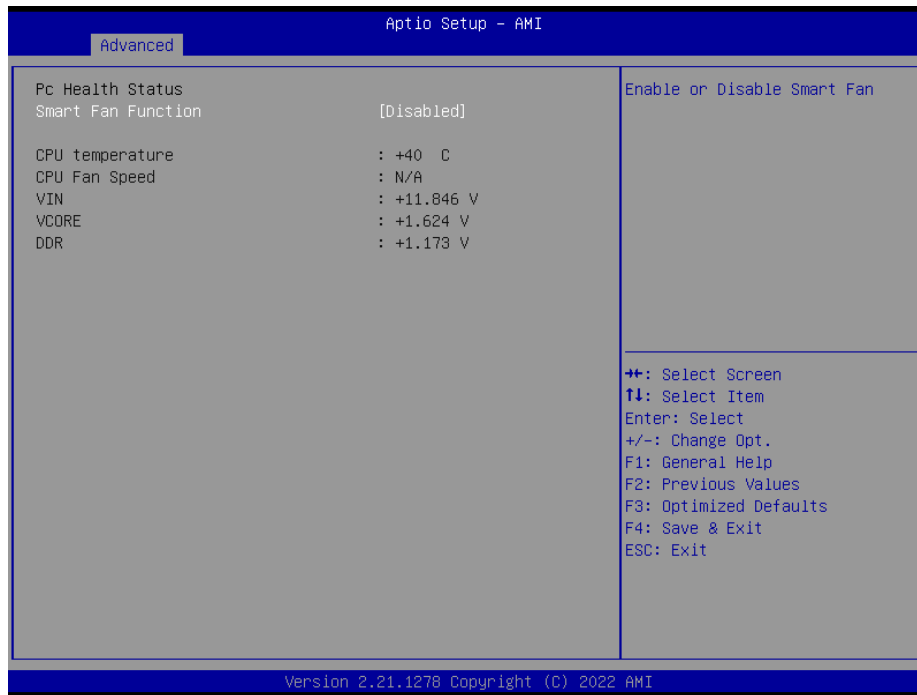

Item	Options	Description
Smart Fan Function	Enabled, Disabled[Default]	Enables or Disables Smart Fan.

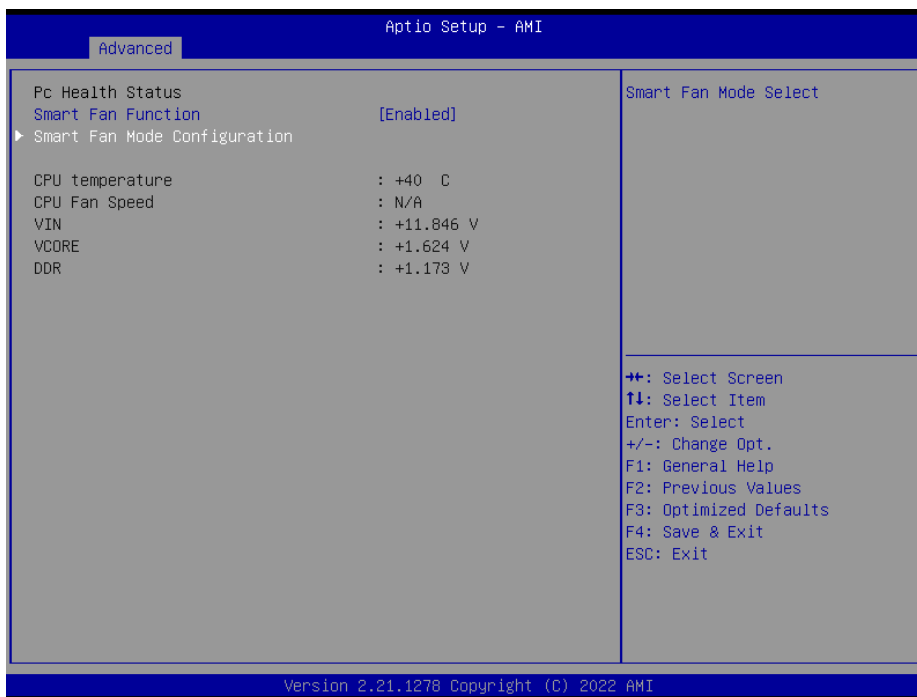

Item	Options	Description
Smart Fan Function	Enabled[Default] Disabled	Enables or Disables Smart Fan.

ESM-EHLC User's Manual

3.6.2.7.1 Smart Fan Mode Configuration

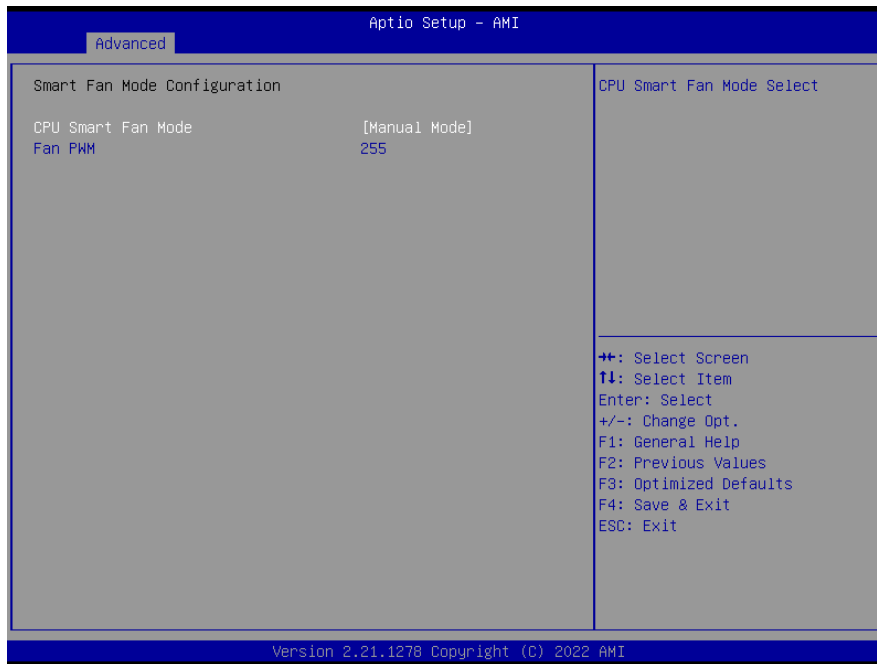

Item	Option	Description
CPU Smart Fan Mode	Manual Mode[Default],/ Mode 01/Mode 02/ Mode 03/ Mode 04/ Mode 05/Mode 06/ Mode 07/ Mode 08/ Mode 09/Mode 10/ Mode 11/ Mode 12/ Mode 13/Mode 14/ Mode 15/ Mode 16/ Mode 17/Mode 18/ Mode 19/ Mode 20	CPU Smart Fan Mode Select.
Fan PWM	255	Fan PWM duty.

3.6.2.8 S5 RTC Wake Settings

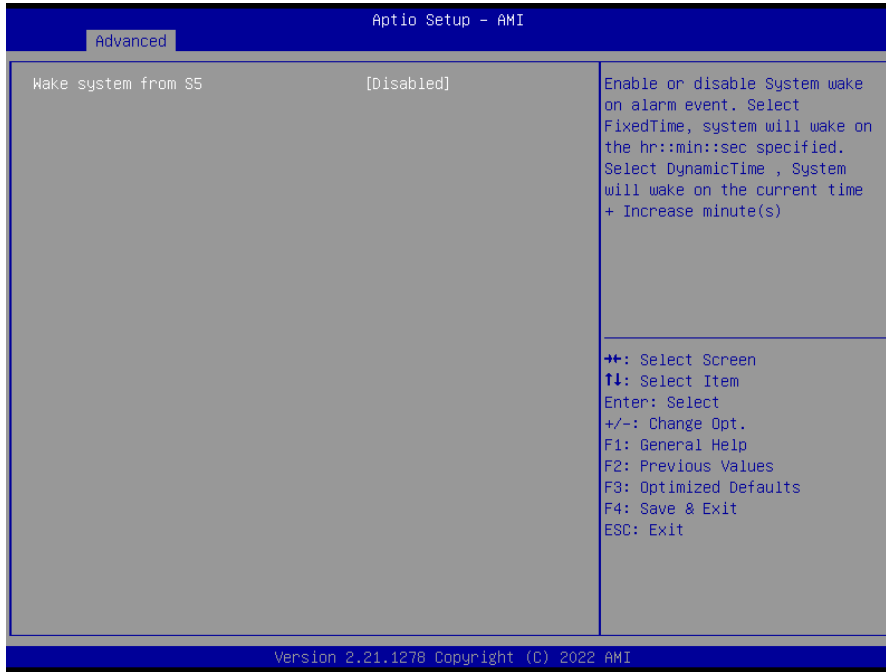

Item	Options	Description
Wake system from S5	Disabled[Default], Fixed Time Dynamic Time	Enable or disable System wake on alarm event. Select Fixed Time, system will wake on the hr::min::sec specified. Select Dynamic Time, System will wake on the current time + Increase minute(s).

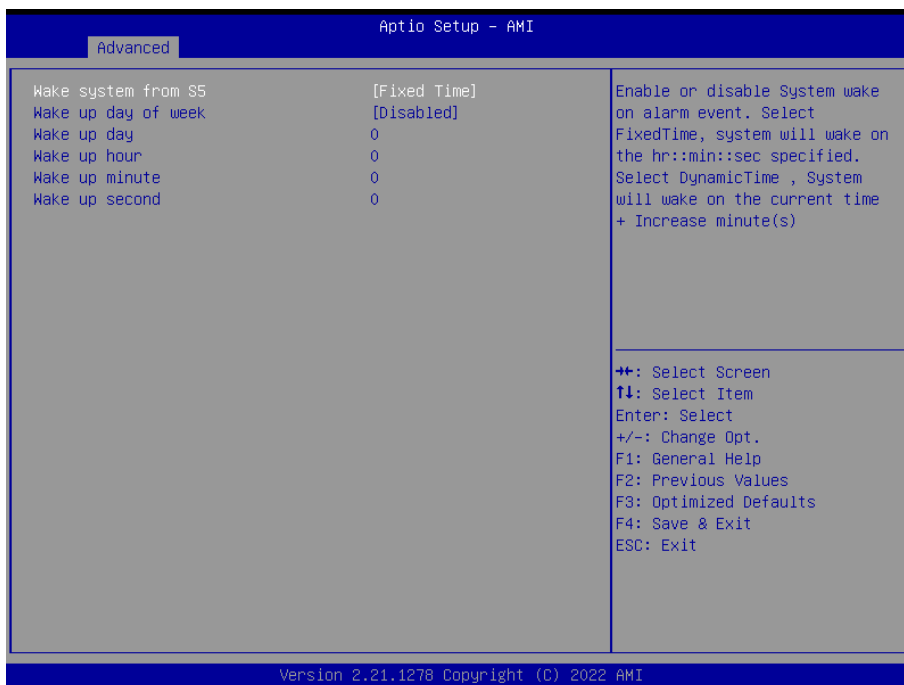

Item	Options	Description
Wake system from S5	Disabled, Fixed Time[Default] Dynamic Time	Enable or disable System wake on alarm event. Select Fixed Time, system will wake on the hr::min::sec specified. Select Dynamic Time, System will wake on

ESM-EHLC User's Manual

		the current time + Increase minute(s).
Wake up day of week	Disabled[Default] Monday-Friday Monday-Saturday	Wake up day of week. (Monday-Friday) or (Monday-Saturday).
Wake up day	1-31	Select 0 for daily system wake up 1-31 for which day of the month that you would like the system to wake up.
Wake up hour	0-23	Select 0-23 For example enter 3 for 3am and 15 for 3pm.
Wake up minute	0-59	Select 0-59 For Minute.
Wake up second	0-59	Select 0-59 For Second.

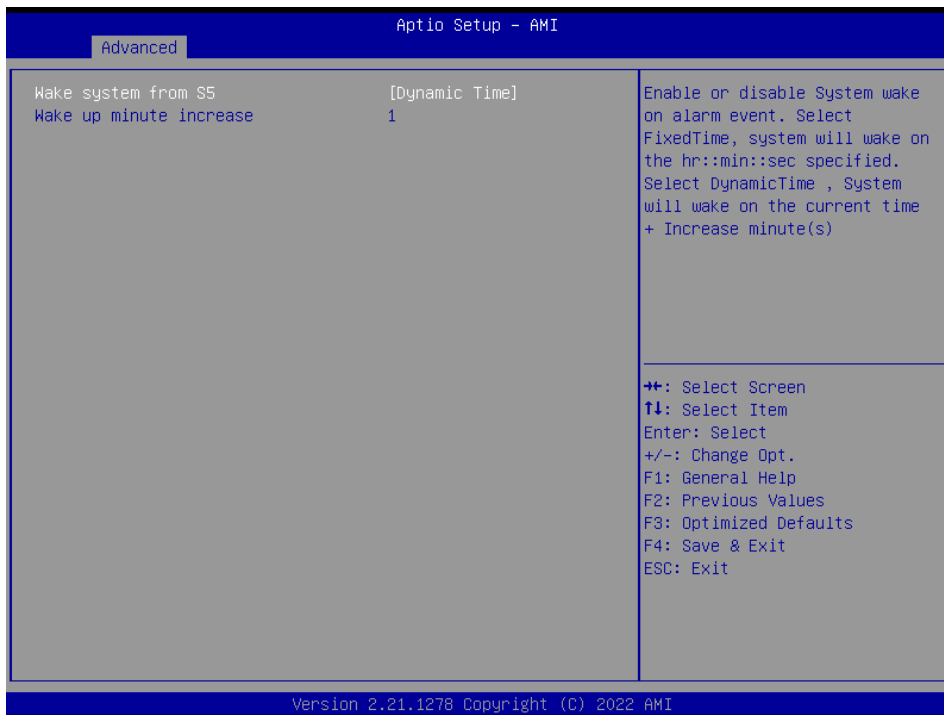

Item	Options	Description
Wake system from S5	Disabled, Fixed Time Dynamic Time[Default]	Enable or disable System wake on alarm event. Select Fixed Time, system will wake on the hr::min::sec specified. Select Dynamic Time, System will wake on the current time + Increase minute(s).
Wake up minute increase	1-5	1-5.

3.6.2.9 Serial Port Console Redirection

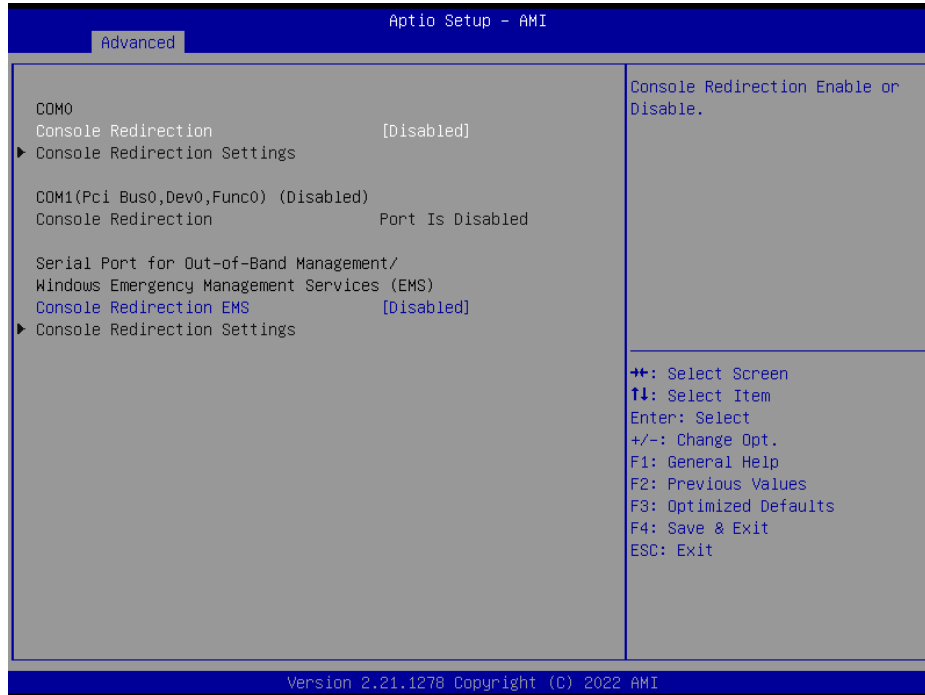

Item	Options	Description
Console Redirection	Disabled[Default], Enabled	Console Redirection Enable or Disable.
Console Redirection EMS	Disabled[Default], Enabled	Console Redirection Enable or Disable.

3.6.2.9.1 COM0

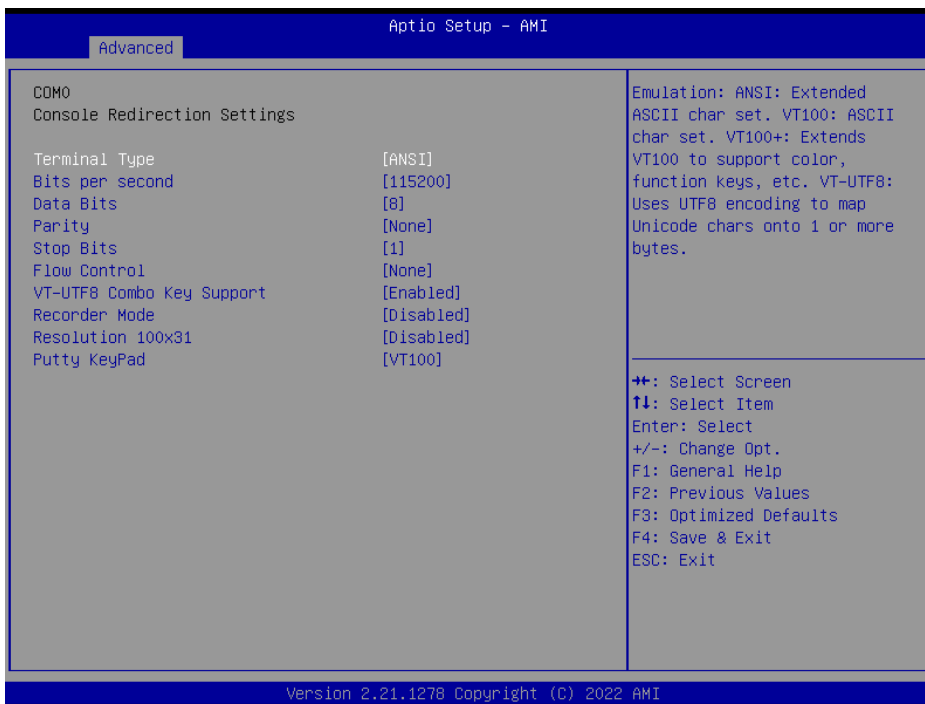

Item	Option	Description
------	--------	-------------

ESM-EHLC User's Manual

Terminal Type	VT100 VT100+ VT-UTF8 ANSI[Default],	Emulation: ANSI: Extender ASCII char set. VT100: ASCII char set. VT100+:Extends VT100 to support color, function keys, etc. VT-UTF8: Uses UTF8 encoding to map Unicode chars onto 1 or more bytes.
Bits per second	9600 19200 38400 57600 115200[Default]	Select serial port transmission speed. The speed must be matched on the other side. Long or noisy lines may require lower speeds.
Data Bits	7 8[Default]	Data Bits.
Parity	None[Default] Even Odd Mark Space	A parity bit can be sent with the data bits to detect some transmission errors. Even: parity bit is 0 if the num of 1's in the data bits is even. Odd: parity bit is 0 if num of 1's in the data bits is odd. Mark: parity bit is always 1. Space: Parity bit is always 0. Mark and Space Parity do not allow for error detection. They can be used as an additional data bit.
Stop Bits	1[Default] 2	Stop bits indicate the end of a serial data packet. (A start bit indicates the beginning). The standard setting is 1 stop bit. Communication with slow devices may require more than 1 stop bit.
Flow Control	None[Default] Hardware RTS/CTS	Flow control can prevent data loss from buffer overflow. When sending data, if the receiving buffers are full, a 'stop' signal can be sent to stop the data flow. Once the buffers are empty, a 'start' signal can be sent to re-start the flow. Hardware flow control uses two wires to send start/stop signals.
VT-UTF8 Combo Key Support	Disabled Enabled[Default]	Enable VT-UTF8 Combination Key Support for ANSI/VT100 terminals.
Recorder Mode	Disabled[Default] Enabled	With this mode enabled only text will be sent. This is to capture Terminal data.
Resolution 100x31	Disabled[Default] Enabled	Enables or disables extended terminal resolution.
Putty KeyPad	VT100[Default] Intel Linux XTERMR6 SCO ESCN VT400	Select FunctionKey and KeyPad on Putty.

3.6.2.9.2 Console Redirection Settings

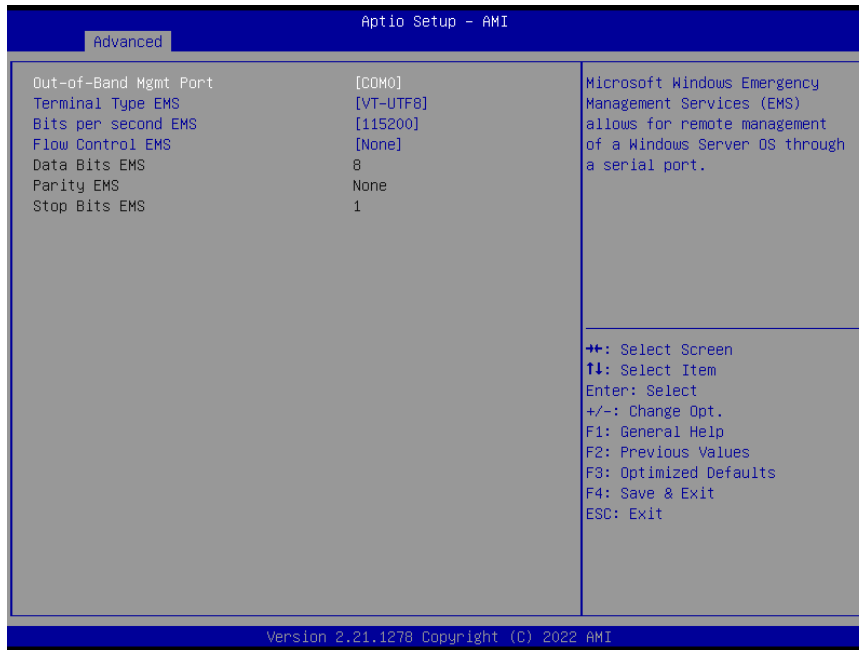

Item	Option	Description
Out-of-Band Mgmt Port	COM0[Default],	Microsoft Windows Emergency Management Services (EMS) allows for remote management of a Windows Server OS through a serial port.
Terminal Type	VT100 VT100+ VT-UTF8[Default], ANSI	VT-UTF8 is the preferred terminal type for out-of-band management. The next best choice is VT100+ and then VT100+ and then VT100. See above, in Console Redirection Settings page, for more Help with Terminal Type/Emulation.
Bits per second	9600 19200 57600 115200[Default]	Select serial port transmission speed. The speed must be matched on the other side. Long or noisy lines may require lower speeds.
Flow Control	None[Default] Hardware RTS/CTS Software Xon/Xoff	Flow control can prevent data loss from buffer overflow. When sending data, if the receiving buffers are full, a 'stop' signal can be sent to stop the data flow. Once the buffers are empty, a 'start' signal can be sent to re-start the flow. Hardware flow control uses two wires to send start/stop signals.

3.6.2.10 USB Configuration

The USB Configuration menu helps read USB information and configures USB settings.

ESM-EHLC User's Manual

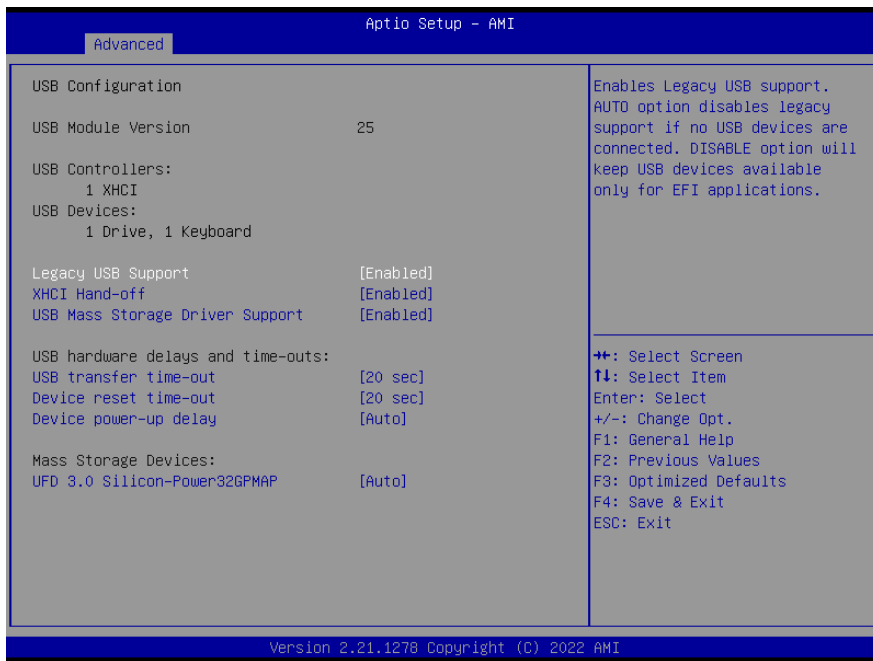

Item	Options	Description
Legacy USB Support	Enabled[Default] Disabled Auto	Enables Legacy USB support. AUTO option disables legacy support if no SUB devices are connected. DISABLE option will keep USB devices available only for EFI applications.
XHCI Hand-off	Enabled[Default] Disabled	This is a workaround for Oses without XHCI hand-off support. The XHCI ownership change should be claimed by XHCI driver.
USB Mass Storage Driver Support	Enabled[Default] Disabled	Enable/Disable USB Mass Storage Driver Support.
USB transfer time-out	1 sec 5 sec 10 sec 20 sec[Default]	The time-out value for Control, Bulk, and Interrupt transfers.
Device reset time-out	10 sec 20 sec[Default] 30 sec 40 sec	USB mass storage device Start Unit command time-out.
Device power-up delay	Auto[Default] Manual	Maximum time the device will take before it properly reports itself to the Host Controller. 'Auto' uses default value: for a Root port it is 100ms, for a Hub port the delay is taken form Hub descriptor.
Mass Storage Devices	Auto[Default] Floppy Forced FDD Hard Disk CD-ROM	Mass storage device emulation type. 'AUTO' enumerates devices according to their media format. Optical drives are emulated as 'CDROM', drives with no media will be emulated according to a drive type.

3.6.2.11 Network Stack Configuration



Item	Options	Description
Network Stack	Enabled Disabled[Default]	Enable/Disable UEFI Network Stack.

ESM-EHLC User's Manual

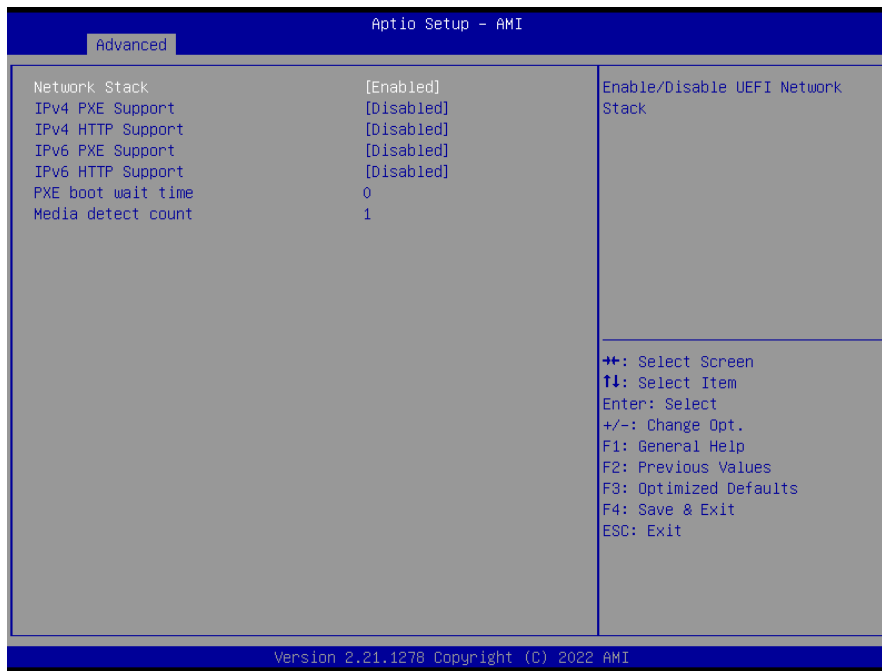

Item	Options	Description
Network Stack	Enabled[Default] Disabled	Enable/Disable UEFI Network Stack.
Ipv4 PXE Support	Enabled Disabled[Default]	Enable Ipv4 PXE Boot Support. If disabled IPV4 PXE boot option will not be created.
Ipv4 HTTP Support	Enabled Disabled[Default]	Enable Ipv4 HTTP Boot Support. If disabled IPV4 HTTP boot option will not be created.
Ipv6 PXE Support	Enabled Disabled[Default]	Enable Ipv6 PXE Boot Support. If disabled IPV6 PXE boot option will not be created.
Ipv6 HTTP Support	Enabled Disabled[Default]	Enable Ipv6 HTTP Boot Support. If disabled IPV4 HTTP boot option will not be created.
PXE boot wait time	0	Wait time to press ESC key to abort the PXE boot.
Media detect count	1	Number of times presence of media will be checked.

3.6.2.12 NVMe Configuration

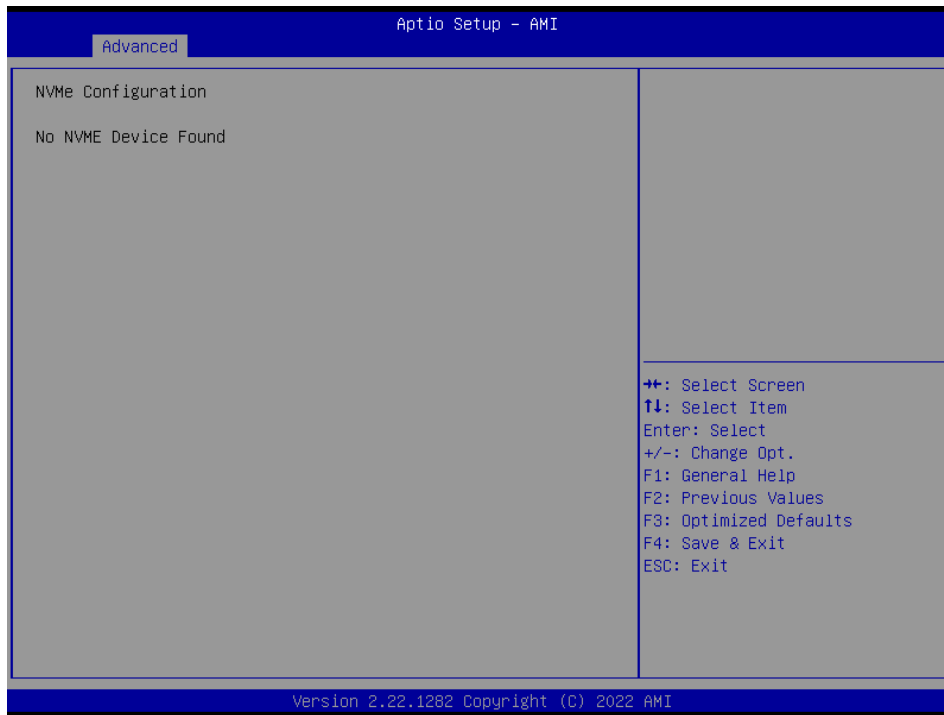

3.6.2.13 User Password Management



ESM-EHLC User's Manual

3.6.3 Chipset



3.6.3.1 System Agent (SA) Configuration

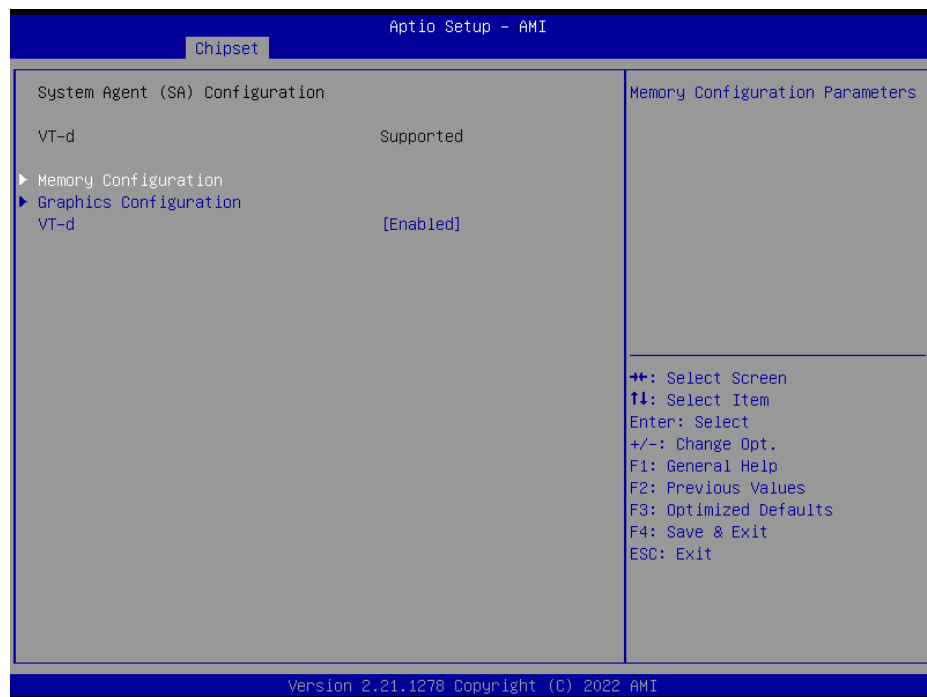

Item	Option	Description
VT-d	Enabled[Default] Disabled	VT-d capability.

3.6.3.1.1 Memory Configuration

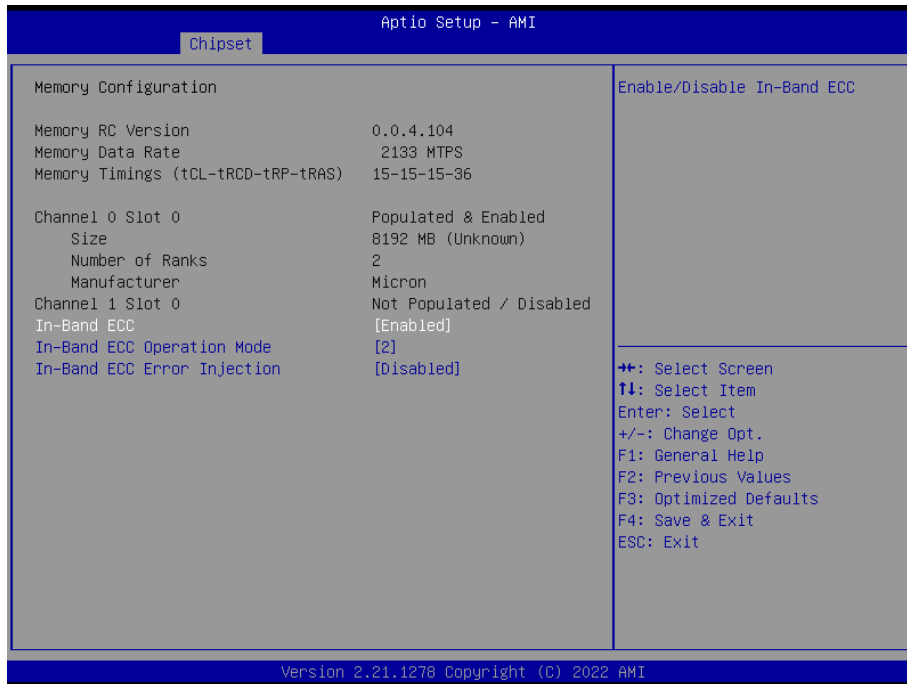

Item	Option	Description
In-Band ECC	Enabled Disabled[Default]	Enable/Disable In-Band ECC.
In-Band ECC Operation Mode	0 1 2[Default]	0: Functional Mode protects requests based on the address range, 1: Makes all requests non protected and ignore range checks, 2: Makes all requests non protected and ignore range checks.
In-Band ECC Error Injection	Enabled Disabled[Default]	By enabling this Error Injection Enabling feature, the user acknowledges the security risks. Enabling Error Injection allows attackers who have access to the Host Operating System to inject IB ECC errors that can cause unintended memory corruption and enable the leak of security data in the BIOS.

ESM-EHLC User's Manual

3.6.3.1.2 Graphics Configuration

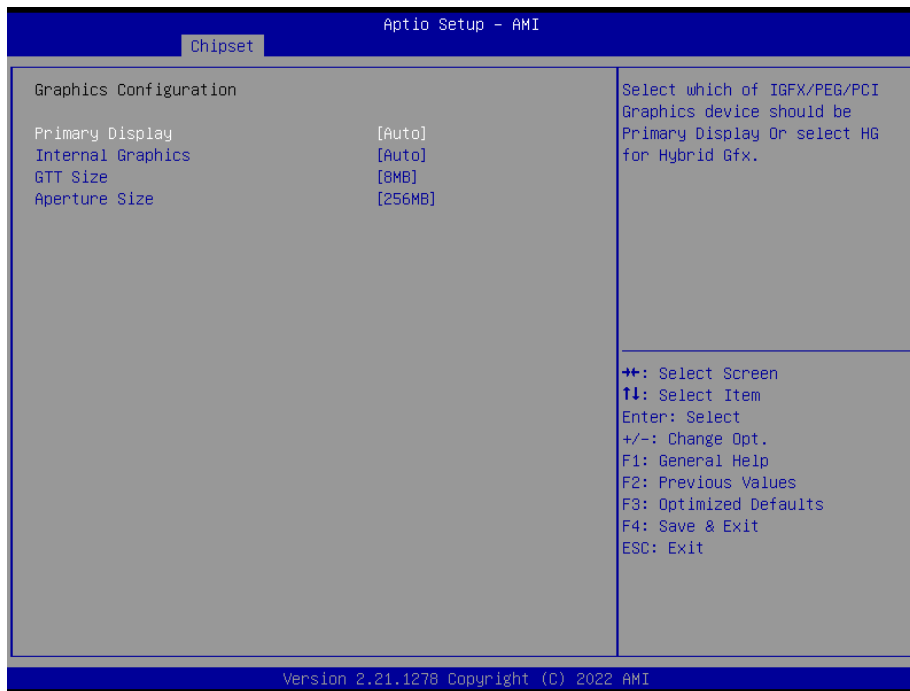

Item	Option	Description
Primary Display	Auto [Default] IGFX PEG PCI	Select which of IGFX/PEG/PCI Graphics device should be Primary Display Or select HG for Hybrid Gfx.
Internal Graphics	Auto [Default] Enabled Disabled	Keep IGFX enabled based on the setup options.
GTT Size	2MB 4MB 8MB [Default]	Select the GTT Size.
Aperture Size	128MB 256MB [Default] 215MB 1024MB 2048MB	Select the Aperture Size Note: Above 4GB MMIO BIOS assignment is automatically enabled when selecting 2048MB aperture. To use this feature, please disable CSM Support.

3.6.3.2 PCH-IO Configuration

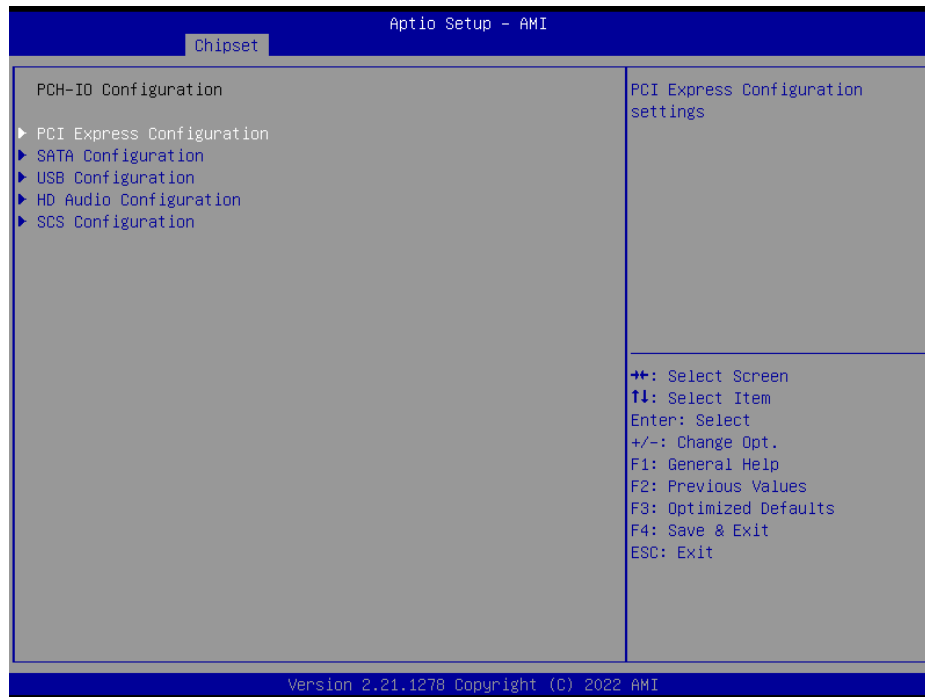

3.6.3.2.1 PCI Express Configuration

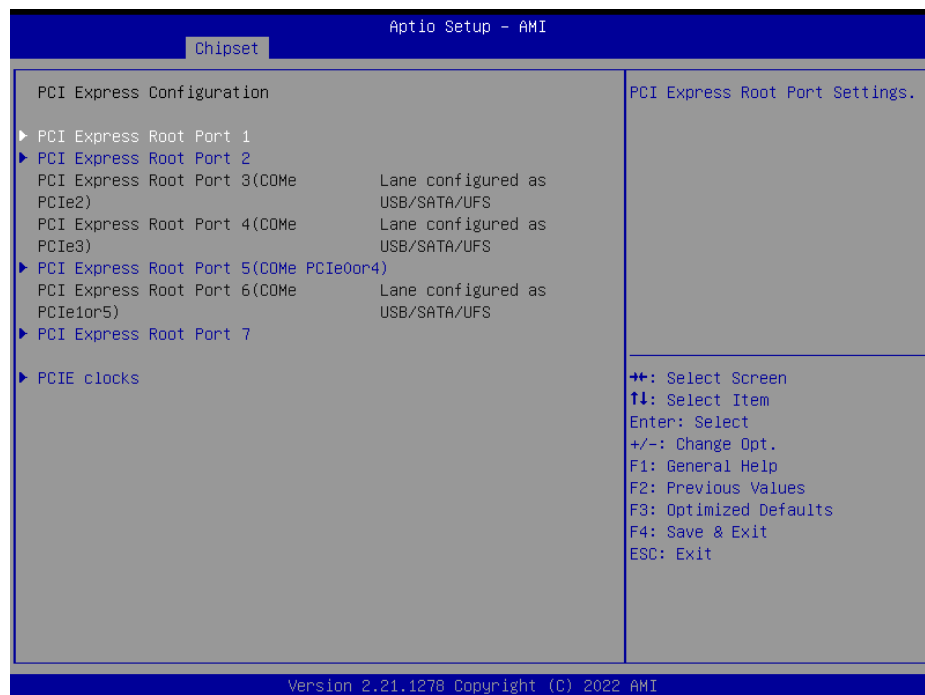

3.6.3.2.1.1 PCI Express Root Port 1

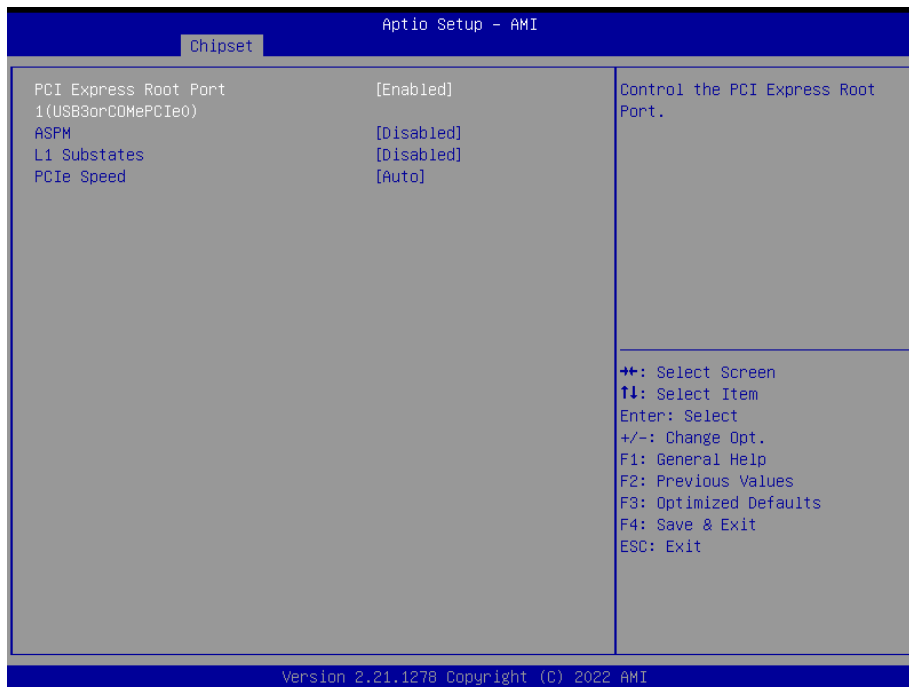

Item	Option	Description
PCI Express Root Port 1(USB3orCOMePCIe0)	Enabled [Default] , Disabled	Control the PCI Express Root Port.
ASPM	Disabled [Default] , L0s L1 L0sL1 Auto	Set the ASPM Level: Force L0s – Force all links to L0s State AUTO – BIOS auto configure DISABLE – Disables ASPM.
L1 Substates	Disabled [Default] L1.1 L1.1 & L1.2	PCI Express L1 Substates settings.
PCIe Speed	Auto [Default] Gen1 Gen2 Gen3	Configure PCIe Speed.

3.6.3.2.1.2 PCI Express Root Port 2

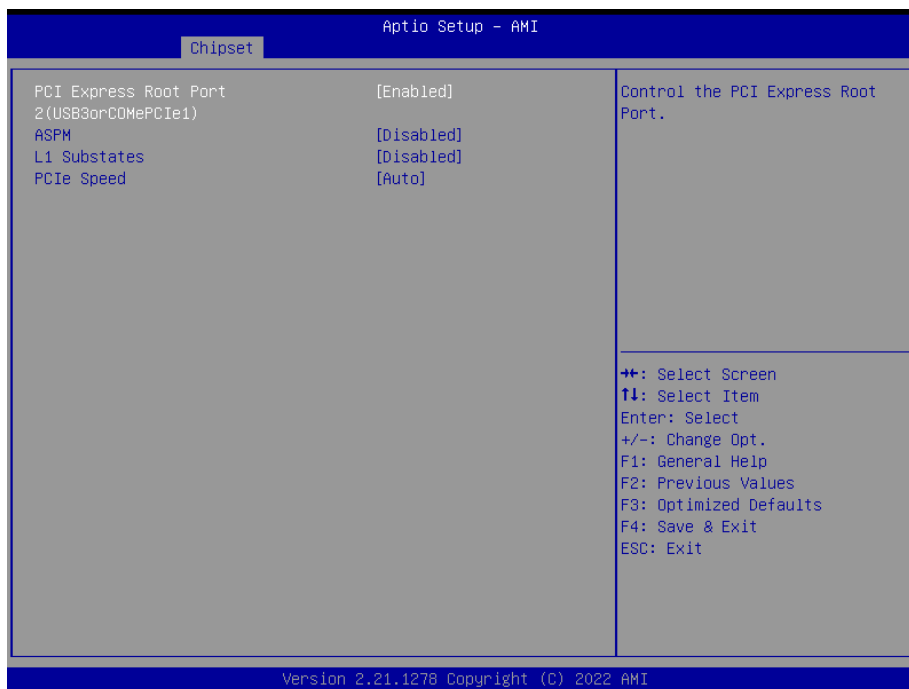

Item	Option	Description
PCI Express Root Port 2(USB3orCOMePCIe1)	Enabled[Default], Disabled	Control the PCI Express Root Port.
ASPM	Disabled[Default], L0s L1 L0sL1 Auto	Set the ASPM Level: Force L0s – Force all links to L0s State AUTO – BIOS auto configure DISABLE – Disables ASPM.
L1 Substates	Disabled[Default] L1.1 L1.1 & L1.2	PCI Express L1 Substates settings.
PCIe Speed	Auto[Default] Gen1 Gen2 Gen3	Configure PCIe Speed.

3.6.3.2.1.3 PCI Express Root Port 5(COMe PCIe0or4)

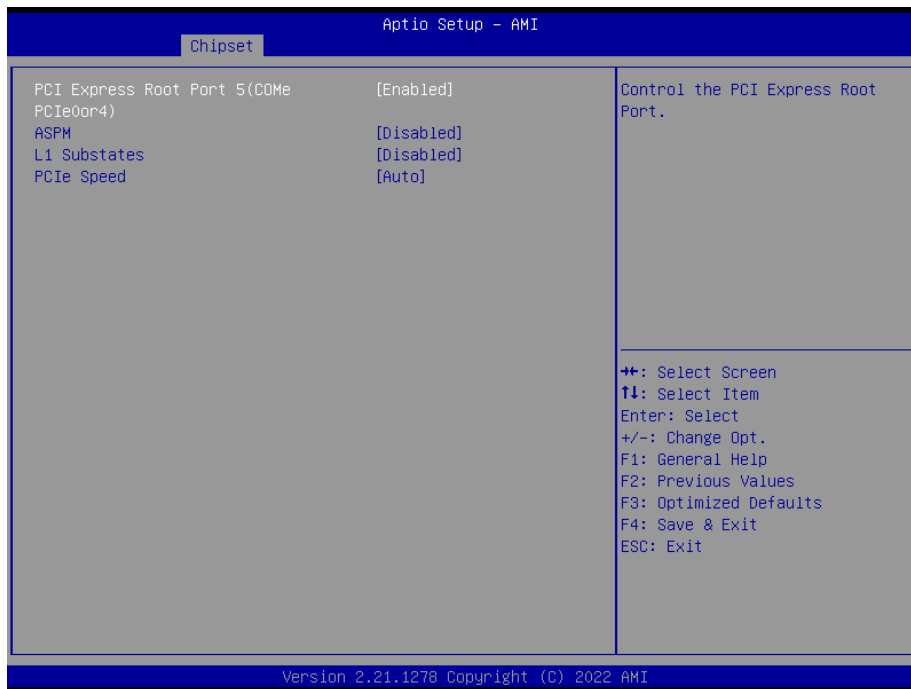

Item	Option	Description
PCI Express Root Port 5(COMe PCIe0or4)	Enabled[Default], Disabled	Control the PCI Express Root Port.
ASPM	Disabled[Default], L0s L1 L0sL1 Auto	Set the ASPM Level: Force L0s – Force all links to L0s State AUTO – BIOS auto configure DISABLE – Disables ASPM.
L1 Substates	Disabled[Default] L1.1 L1.1 & L1.2	PCI Express L1 Substates settings.
PCIe Speed	Auto[Default] Gen1 Gen2 Gen3	Configure PCIe Speed.

3.6.3.2.1.4 PCI Express Root Port 7

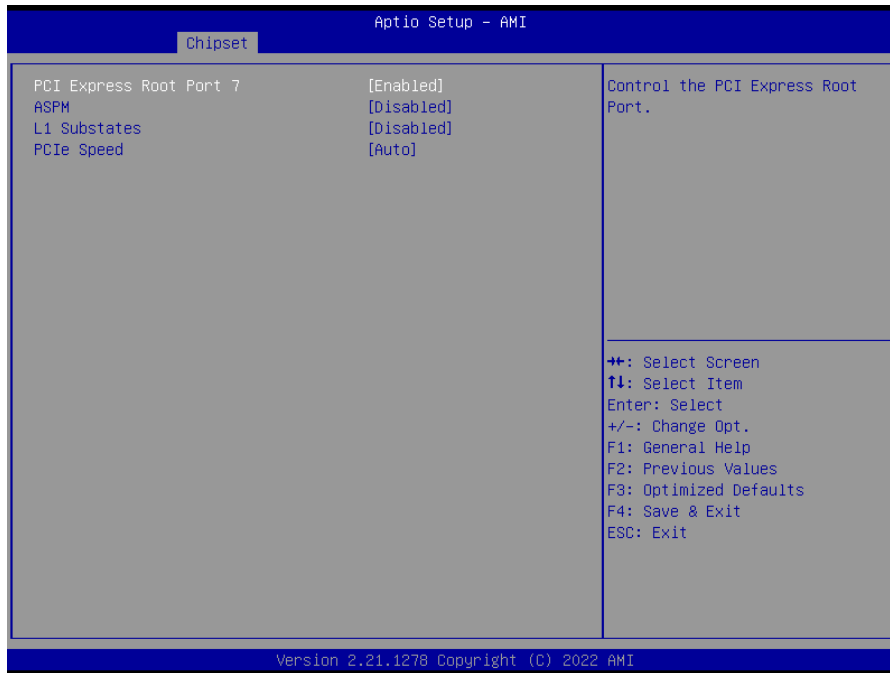

Item	Option	Description
PCI Express Root Port 7	Enabled[Default], Disabled	Control the PCI Express Root Port.
ASPM	Disabled[Default], L0s L1 L0sL1 Auto	Set the ASPM Level: Force L0s – Force all links to L0s State AUTO – BIOS auto configure DISABLE – Disables ASPM.
L1 Substates	Disabled[Default] L1.1 L1.1 & L1.2	PCI Express L1 Substates settings.
PCIe Speed	Auto[Default] Gen1 Gen2 Gen3	Configure PCIe Speed.

3.6.3.2.1.5 PCIE clocks

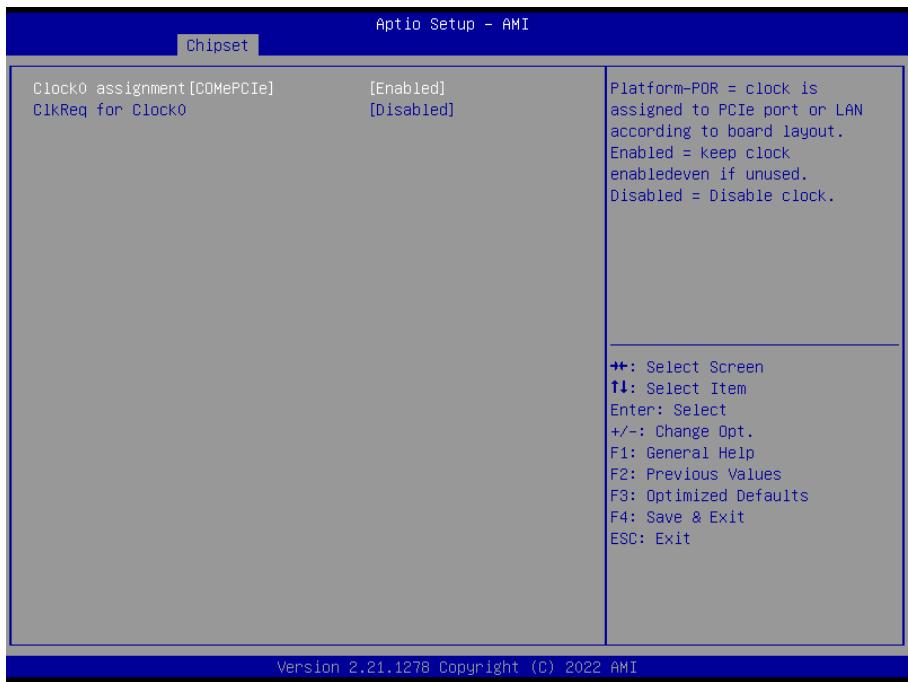

Item	Option	Description
Clock0 assignment[COMePCIe]	Platform-POR Enabled[Default], Disabled	Platform-POR= clock is assigned to PCIe port or LAN according to board layout. Enabled = keep clock enabled even if unused. Disabled = Disable clock.
ClkReq for Clock0	Platform-POR Disabled[Default],	Platform-POR= CLKREQ signal is assigned to CLKSRC according to board layout. Disabled = CLKREQ will not be used.

3.6.3.2.2 SATA And RST Configuration

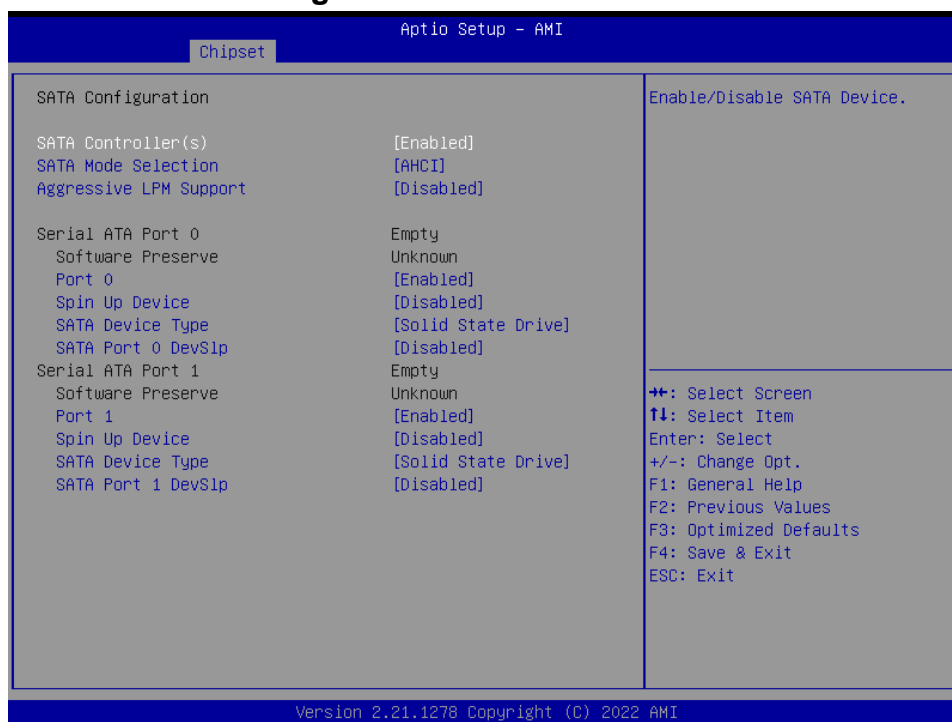

Item	Options	Description
SATA Controller(s)	Enabled[Default] Disabled,	Enable/Disable SATA Device.
SATA Mode Selection	AHCI[Default]	Determines how SATA controller(s) operate.
Aggressive LPM Support	Enabled Disabled[Default]	Enable PCH to aggressively enter link power state.
Port 0	Enabled[Default] Disabled	Enable or Disable SATA Port.
Spin Up Device	Enabled Disabled[Default]	If enabled for any of ports Staggered Spin Up will be performed and only the drives which have this option enabled will spin up at boot. Otherwise all drives spin up at boot.
SATA Device Type	Hard Disk Drive Solid State Drive[Default]	Identify the SATA port is connected to Solid State Drive or Hard Disk Drive.
SATA Port 0 DevSlp	Enabled Disabled[Default]	Enable/Disable SATA Port 0 DevSlp. For DevSlp to work, both hard drive and SATA port need to support DevSlp function, otherwise an unexpected behaviour might happen. Please check board design before enabling it.
Port 1	Enabled[Default] Disabled	Enable or Disable SATA Port.
Spin Up Device	Enabled Disabled[Default]	If enabled for any of ports Staggered Spin Up will be performed and only the drives which have this option enabled will spin up at boot. Otherwise all drives spin up at boot.

ESM-EHLC User's Manual

SATA Device Type	Hard Disk Drive Solid State Drive[Default]	Identify the SATA port is connected to Solid State Drive or Hard Disk Drive.
SATA Port 1 DevSlp	Enabled Disabled[Default]	Enable/Disable SATA Port 0 DevSlp. For DevSlp to work, both hard drive and SATA port need to support DevSlp function, otherwise an unexpected behaviour might happen. Please check board design before enabling it.

3.6.3.2.3 USB Configuration

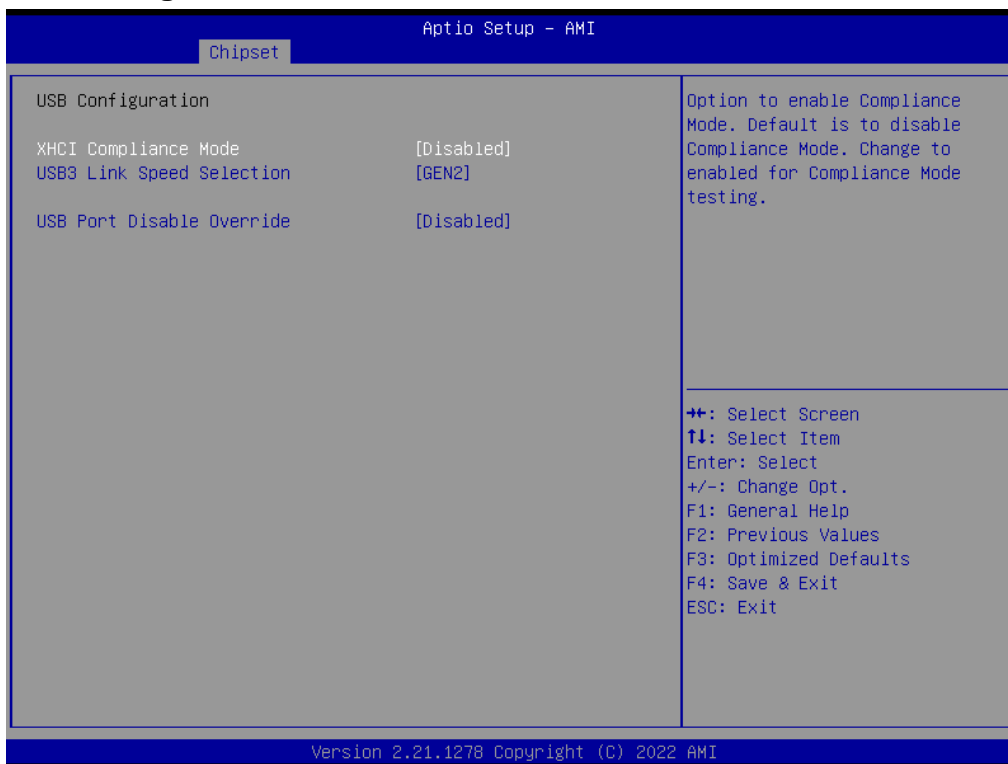

Item	Option	Description
XHCI Compliance Mode	Disabled[Default] Enabled	Option to enable Compliance Mode. Default is to disable Compliance Mode. Change to enabled for Compliance Mode testing.
USB3 Link Speed Selection	GEN1 GEN2[Default]	This option is to select USB3 Link Speed GEN1 or GEN2.
USB Port Disable Override	Disabled[Default] Select Per-Pin	Selectively Enable/Disable the corresponding USB port from reporting a Device Connection to the controller.

3.6.3.2.4 HD Audio Configuration

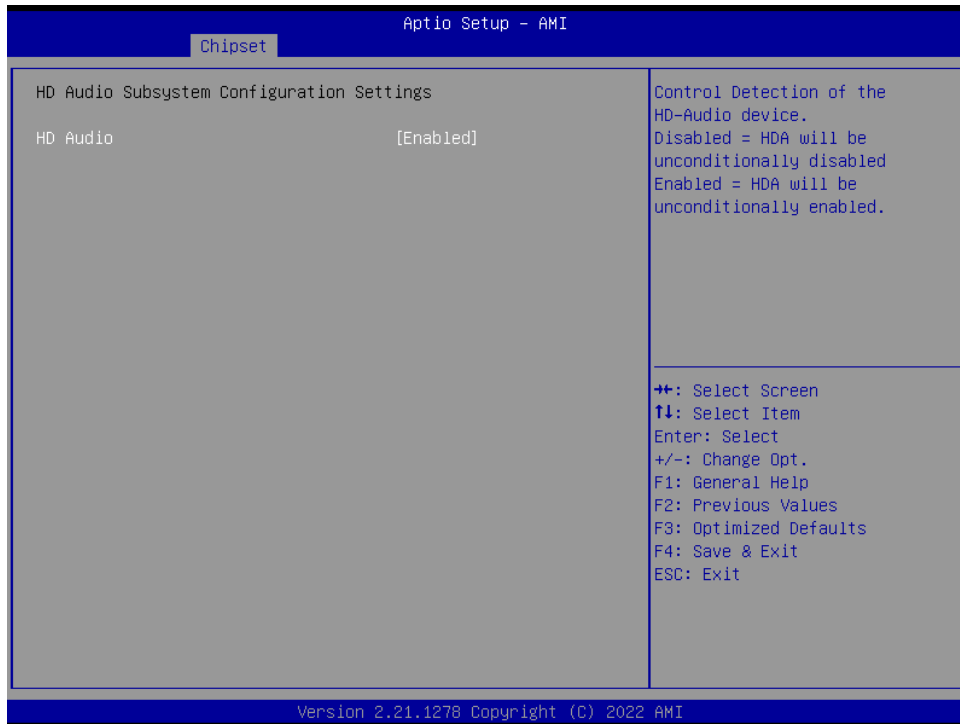

Item	Option	Description
HD Audio	Disabled Enabled[Default]	Control Detection of the HD-Audio device. Disable = HDA will be unconditionally disabled Enabled = HDA will be unconditionally enabled.

3.6.3.2.5 SCS Configuration

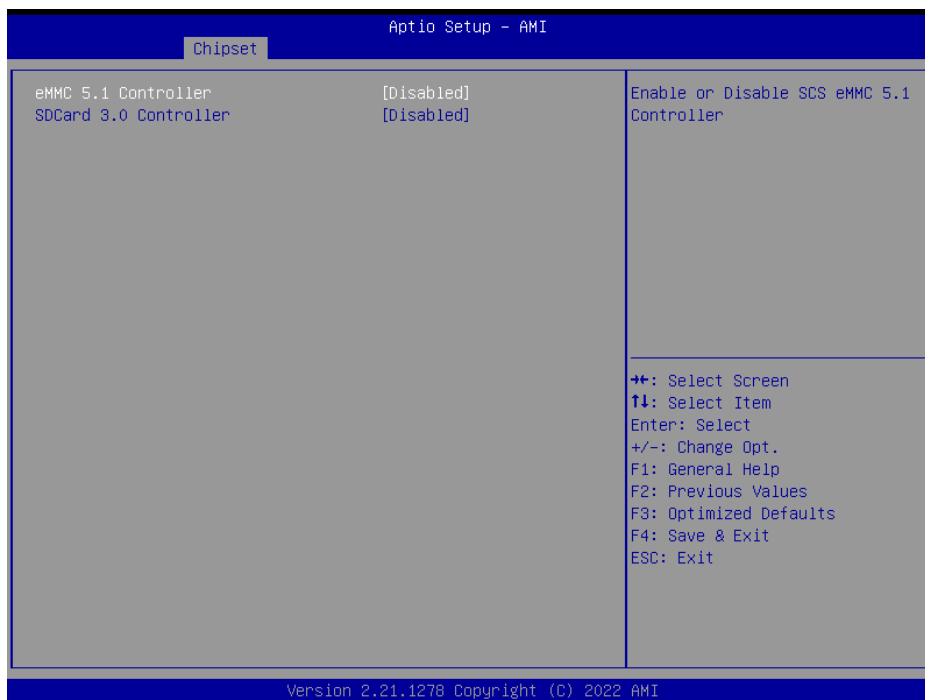

ESM-EHLC User's Manual

Item	Option	Description
eMMC 5.1 Controller	Disabled[Default] Enabled	Enable or Disable SCS eMMC5.1 Controller.
SDCard 3.0 Controller	Disabled[Default] Enabled	Enable or Disable SCS SDHC 3.0 Controller.

3.6.3.3 Board & Panel Configuration

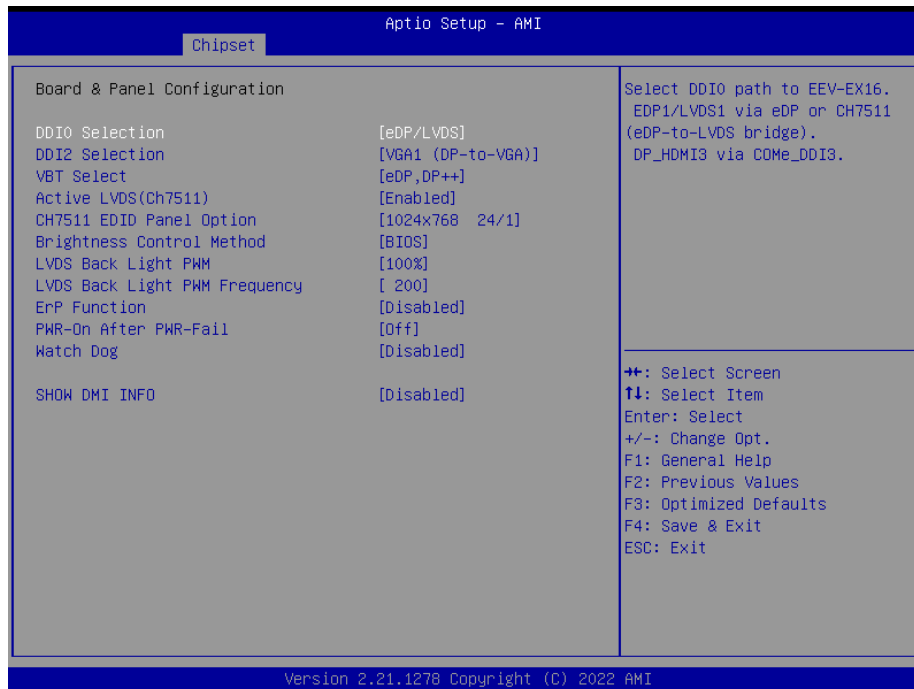

Item	Option	Description
DDI0 Selection	eDP/LVDS[Default] DP_HDMI3	Select DDI0 path to EEV-EX16. EDP1/LVDS1 via eDP or CH7511 (eDP-to-LVDS bridge). DP_HDMI3 via COMe_DDI3.
DDI2 Selection	VGA1(DP-to-VGA)[Default] DP_HDMI2	Select DDI2 path to EEV-EX16. VGA1 via CH7517 (DP-to-VGA bridge) to COMe_VGA. DP_HDMI2 via COMe_DDI2.
VBT Select	eDP, DP++[Default] HDMI only DP++	eDP, DP++-EDP1 or LVDS1, DP-HDMI1/DP_HDMI2 is DP++ HDMI only – DP_HDMI1~3 are HDMI for 4K DP++- DP_HDMI1~3 are DP++ for DP/HDMI.
Active LVDS(Ch7511)	Disabled Enabled[Default]	Active Internal LVDS(eDP->Ch7511-to-LVDS).
CH7511 EDID Panel Option	1024x768 24/1[Default] 800x600 18/1 1024x768 18/1 1366x768 18/1 1024x600 18/1 1280x800 18/1	Port1-EDP to LVDS(Chrotel 7511) Panel EDID Option.

	1920x1200 24/2 640x480 18/1 800x480 18/1 1920x1080 18/2 1280x1024 24/2 1440x900 18/2 1600x1200 24/2 1366x768 24/1 1920x1080 24/2 1680x1050 24/2	
Brightness Control Method	BIOS[Default] OS Driver	LVDS Brightness Control Method. 1.BIOS 2.OS Driver.
LVDS Back Light PWM	00% 25% 50% 75% 100%[Default]	Select LVDS back light PWM duty.
LVDS Back Light PWM Frequency	200[Default] 300 400 500 700 1k 2k 3k 5k 10k 20k	Select LVDS back light PWM Frequency.
ErP Function	Disabled[Default] Enabled	ErP Function (Deep S5).
PWR-On After PWR-Fail	Off[Default] On Last state	AC loss resume.
Watch Dog	Disabled[Default] 30 sec 40 sec 50 sec 1 min 2 min 10 min 30 min	Select WatchDog.

3.6.4 Security



- **Administrator Password**

Set setup Administrator Password

- **User Password**

Set User Password

3.6.5 Boot

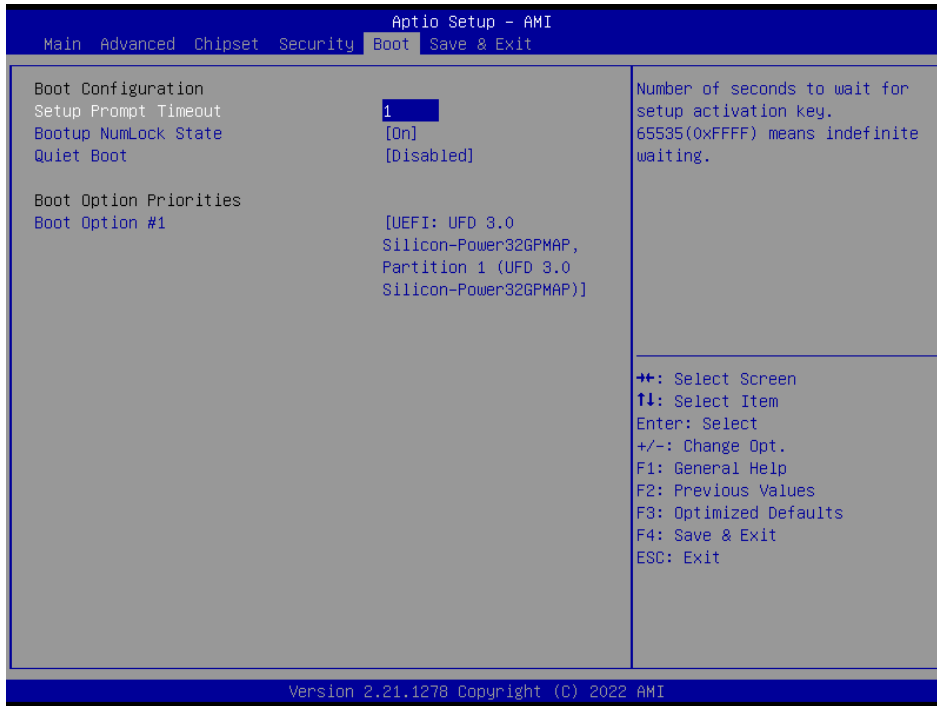

Item	Option	Description
Setup Prompt Timeout	1~ 65535	Number of seconds to wait for setup activation key. 65535(0xFFFF) means indefinite waiting.
Bootup NumLock State	On[Default] Off	Select the keyboard NumLock state
Quiet Boot	Disabled[Default] Enabled	Enables or disables Quiet Boot option
Boot Option #1	Set the system boot order.	

3.6.6 Save and exit



3.6.6.1 Save Changes and Reset

Reset the system after saving the changes.

3.6.6.2 Discard Changes and Reset

Any changes made to BIOS settings during this session of the BIOS setup program are discarded. The setup program then exits and reboots the controller.

3.6.6.3 Restore Defaults

This option restores all BIOS settings to the factory default. This option is useful if the controller exhibits unpredictable behavior due to an incorrect or inappropriate BIOS setting.

3.6.6.4 Launch EFI Shell from filesystem device

Attempts to Launch EFI Shell application (Shellx64.efi) from one of the available filesystem devices.

4. Drivers Installation



Note: Installation procedures and screen shots in this section are for your reference and may not be exactly the same as shown on your screen.

ESM-EHLC User's Manual

4.1 Install Chipset Driver

All drivers can be found on the Avalue Official Website:

<http://www.avalue.com.tw>.



Note: The installation procedures and screen shots in this section are based on Windows 10 operation system. If the warning message appears while the installation process, click Continue to go on.



Step 3. Click Install.



Step1. Click Next.



Step 4. Complete setup.



Step 2. Click Accept.

4.2 Install HID Driver

All drivers can be found on the Avalue Official Website:

<http://www.avalu.com.tw>.



Note: The installation procedures and screen shots in this section are based on Windows 10 operation system. If the warning message appears while the installation process, click Continue to go on.

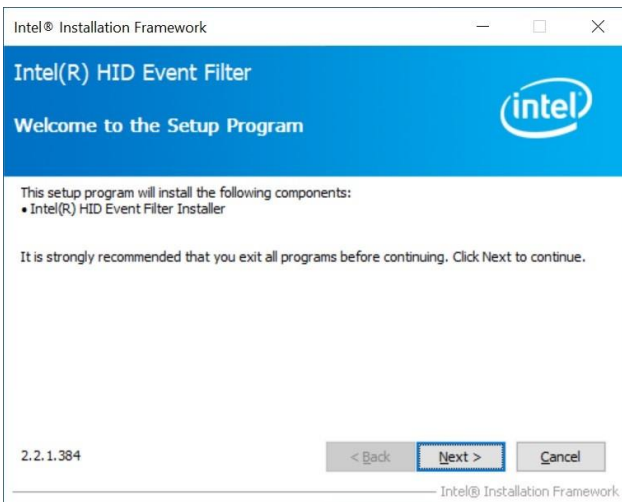

Step1. Click **Next** to start installation.

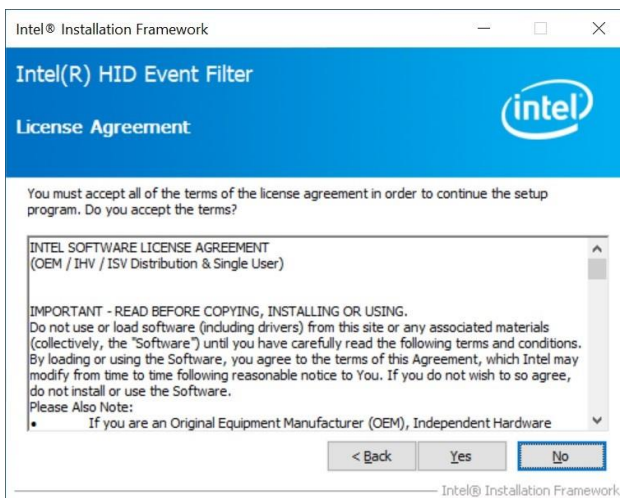

Step 2. Click **Yes**.

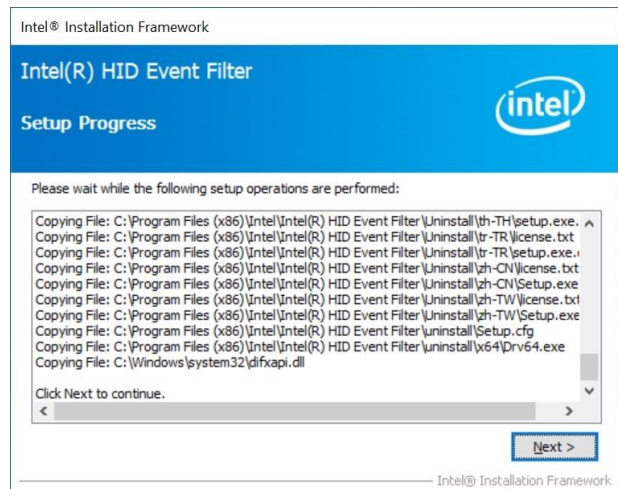

Step 3. Click **Next** to continue installation.

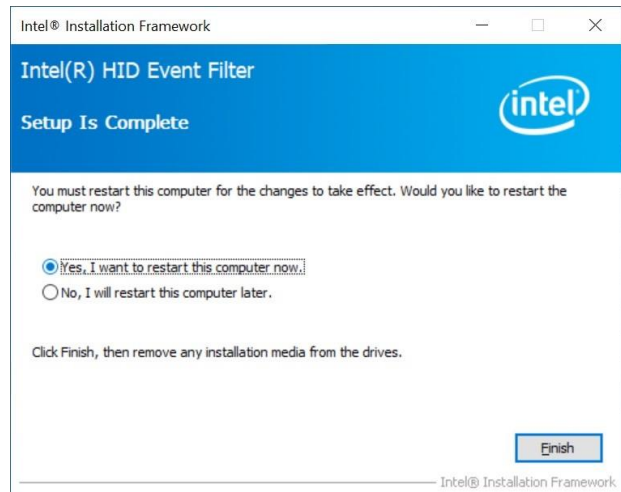

Step 4. Click **Finish** to complete setup.

4.3 Install VGA Driver

All drivers can be found on the Avalue Official Website:

<http://www.avalue.com.tw>.



Note: The installation procedures and screen shots in this section are based on Windows 10 operation system.

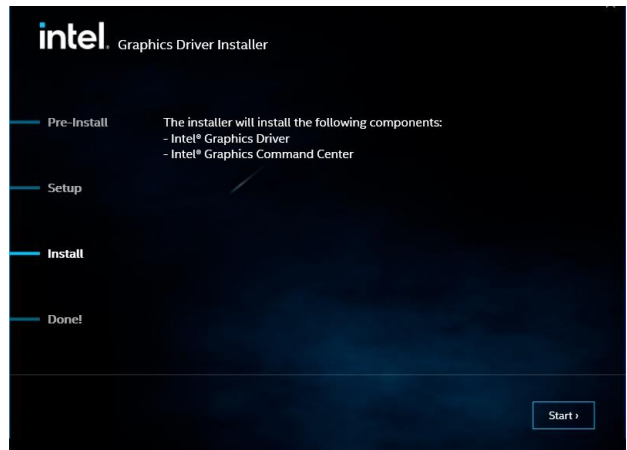

Step 3. Click Start.

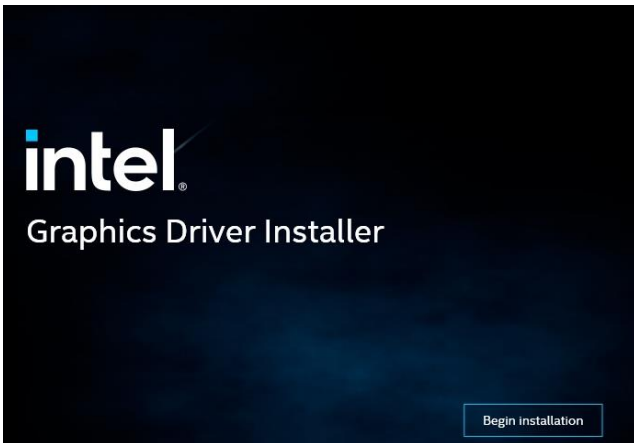

Step 1. Click Begin installation.

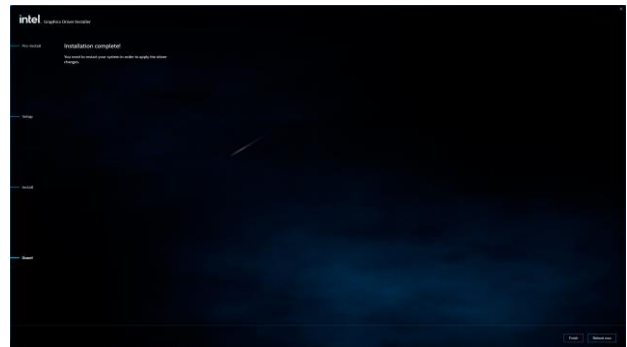

Step 4. Complete setup.

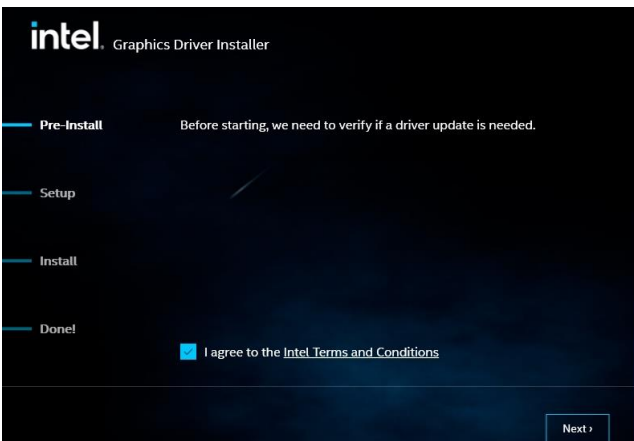

Step 2. Click Next.

4.4 Install Audio Driver

All drivers can be found on the Avalue Official Website:

<http://www.avalue.com.tw>.



Note: The installation procedures and screen shots in this section are based on Windows 10 operation system.

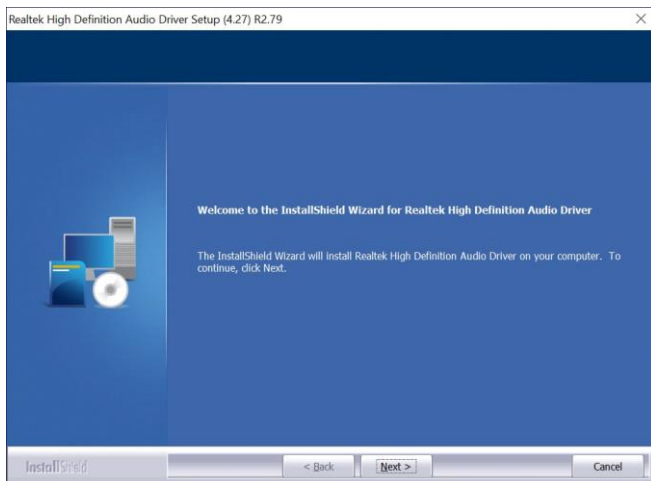

Step 1. Click **Next** to continue setup.

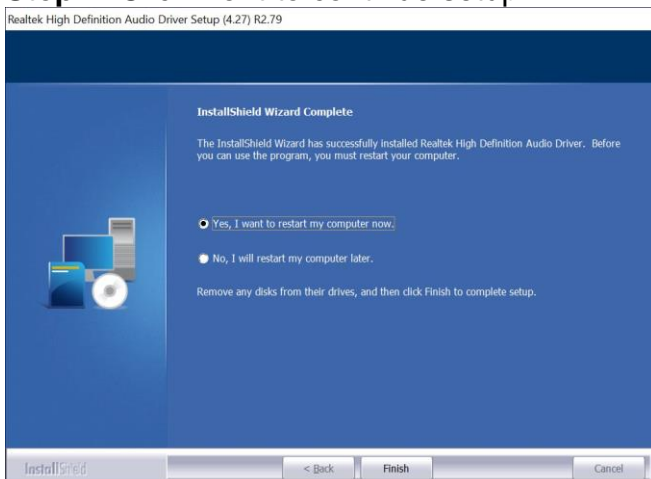

Step 2. Click **Finish** to complete the setup.

ESM-EHLC User's Manual

4.5 Install Ethernet Driver

All drivers can be found on the Avalue Official Website:

<http://www.avalue.com.tw>.



Note: The installation procedures and screen shots in this section are based on Windows 10 operation system.

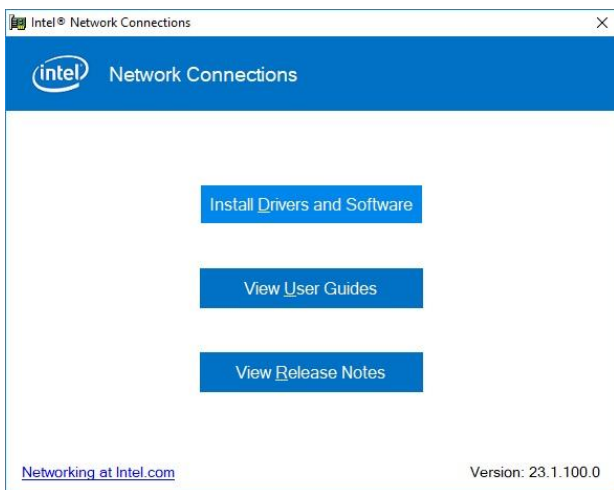

Step 1. Click Install Drivers and Software.

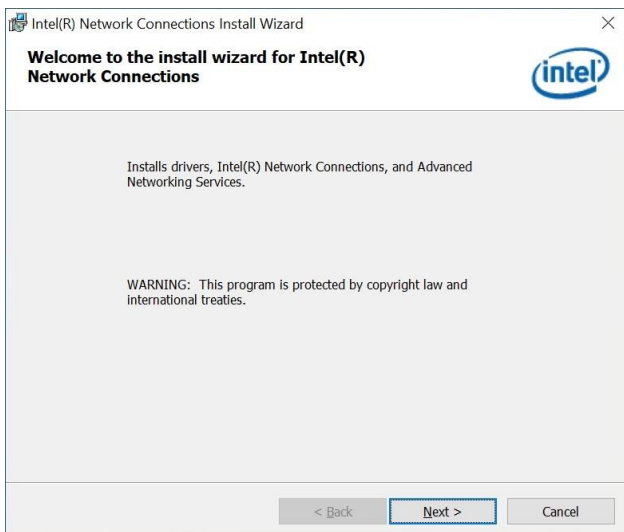

Step 2. Click Next.

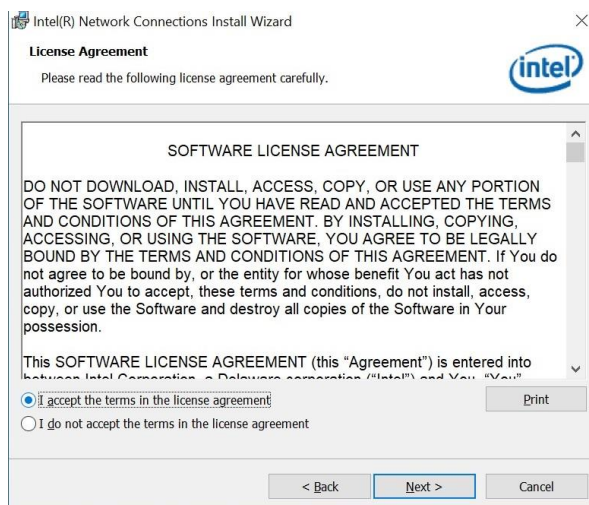

Step 3. Click Next to continue setup.

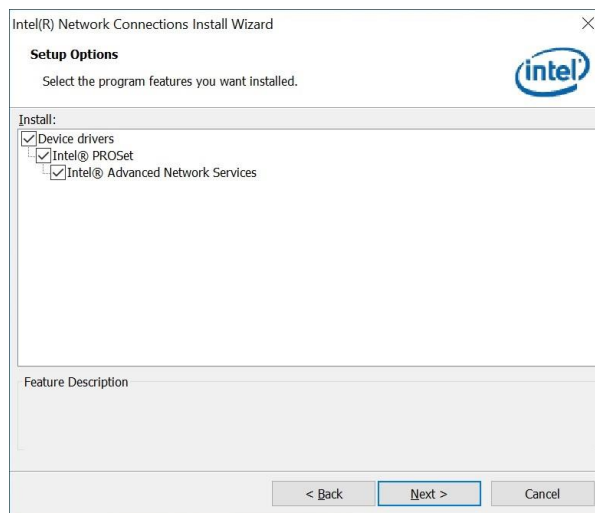

Step 4. Click Next.

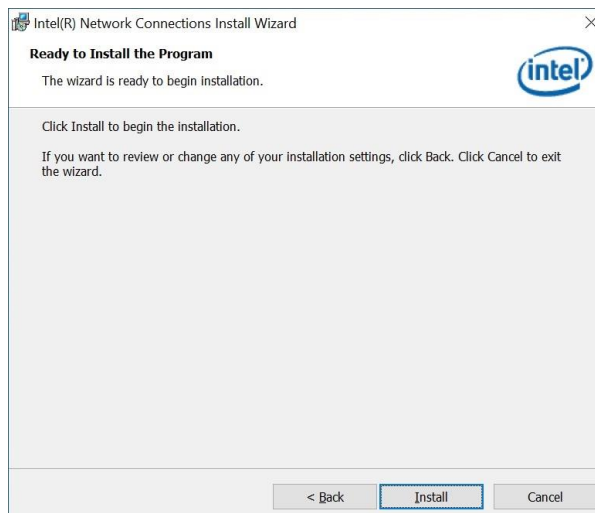

Step 5. Click Install.

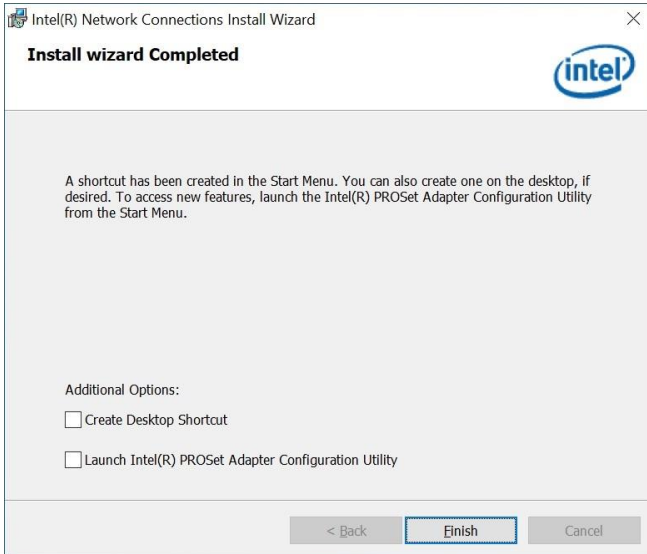

Step 6. Click **Finish** to complete the setup.

4.6 Install ME Driver

All drivers can be found on the Avalue Official Website:

<http://www.avalu.com.tw>.



Note: The installation procedures and screen shots in this section are based on Windows 10 operation system. If the warning message appears while the installation process, click Continue to go on.

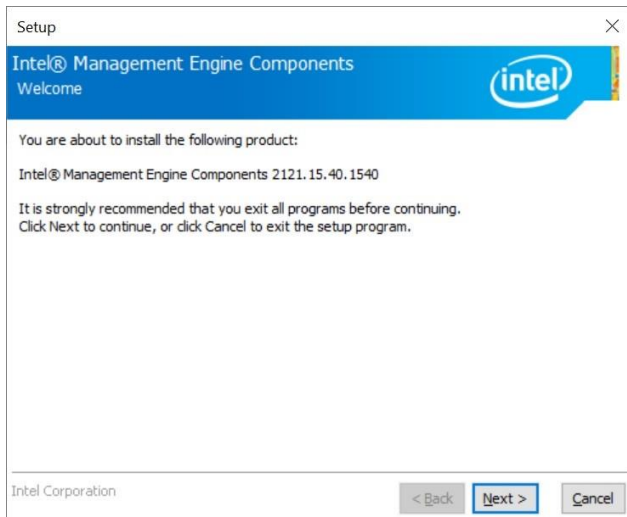

Step1. Click **Next** to start installation.

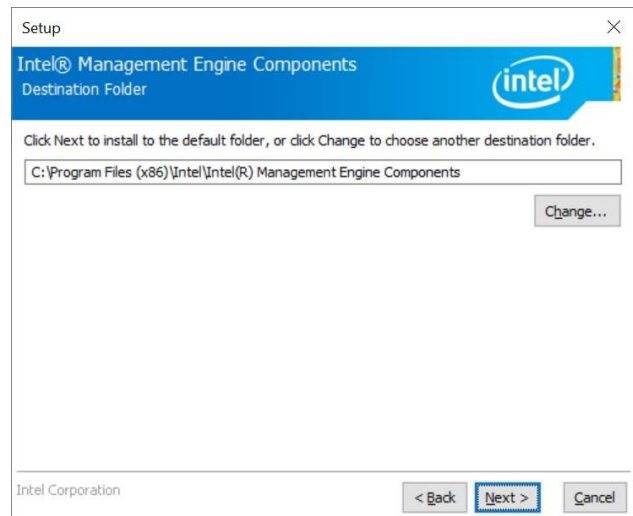

Step 3. Click **Next** to continue installation.

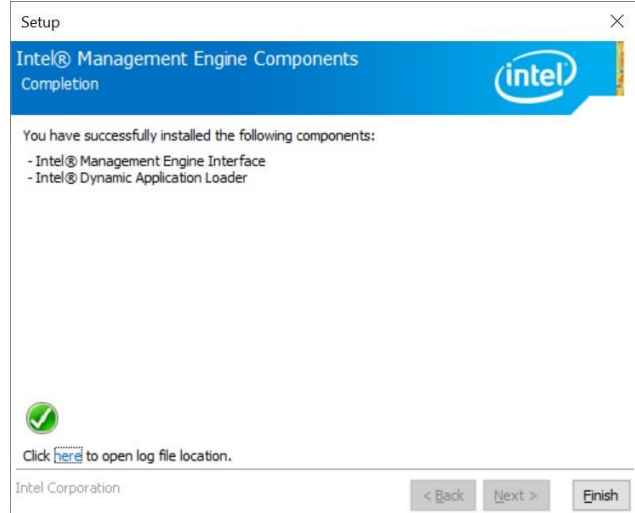

Step 4. Click **Finish** to complete setup.

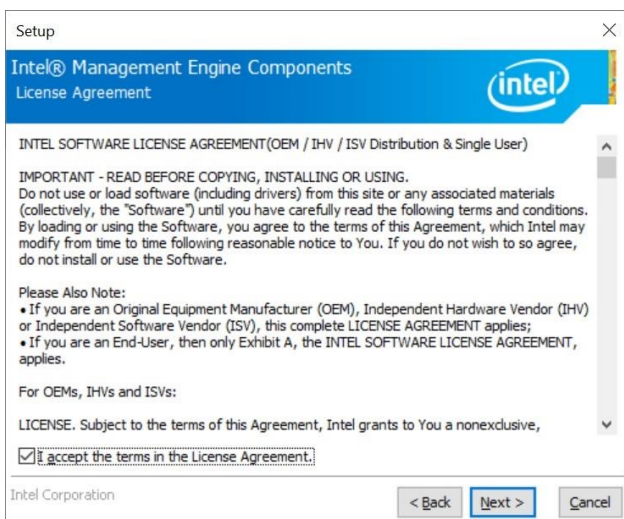

Step 2. Click **Next**.

4.7 Install SIO Driver

All drivers can be found on the Avalue Official Website:

<http://www.avalue.com.tw>.



Note: The installation procedures and screen shots in this section are based on Windows 10 operation system. If the warning message appears while the installation process, click Continue to go on.

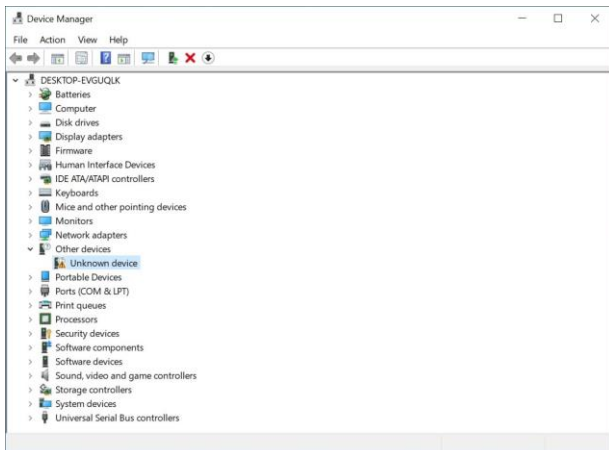

Step1. Click **Unknown device** to start installation.

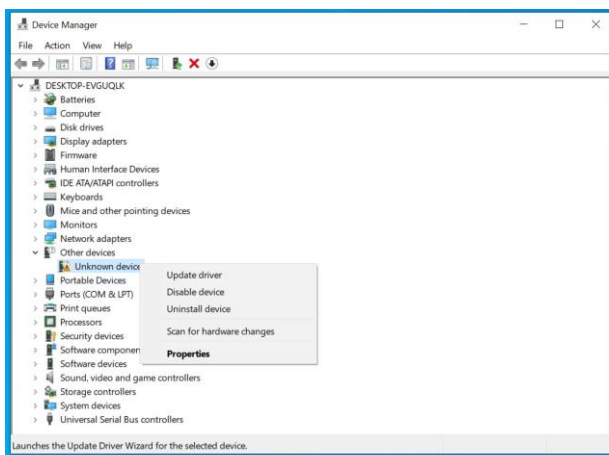

Step 2. Click **Update Drivers**.

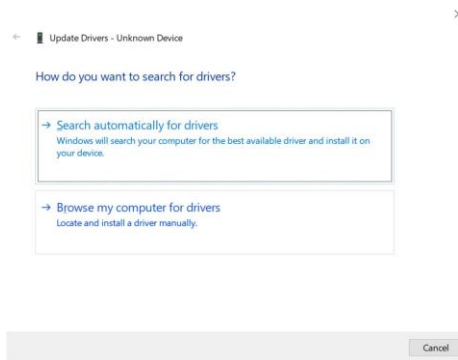

Step 3. Click **Search automatically for drivers**.

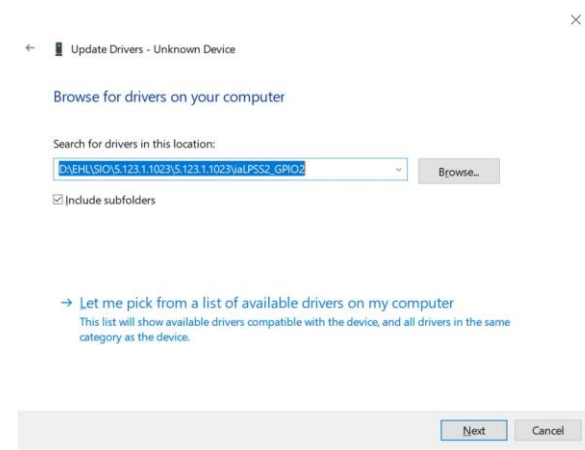

Step 4. Click **Next**.

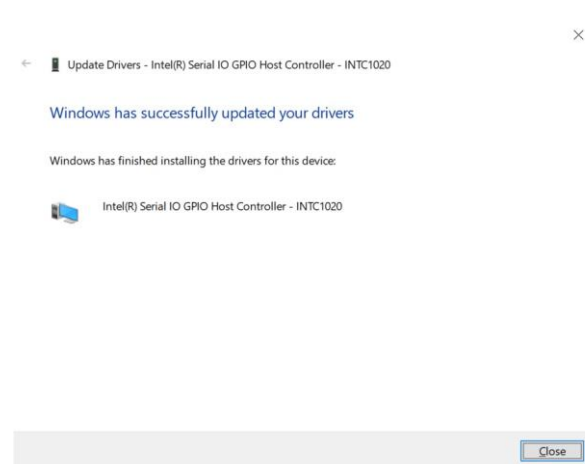

Step 5. Complete setup

5. Mechanical Drawing

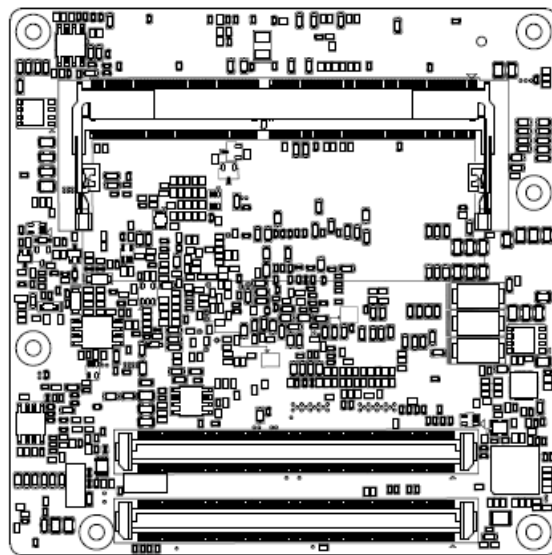
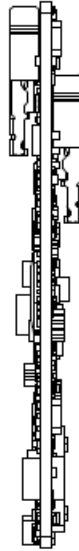
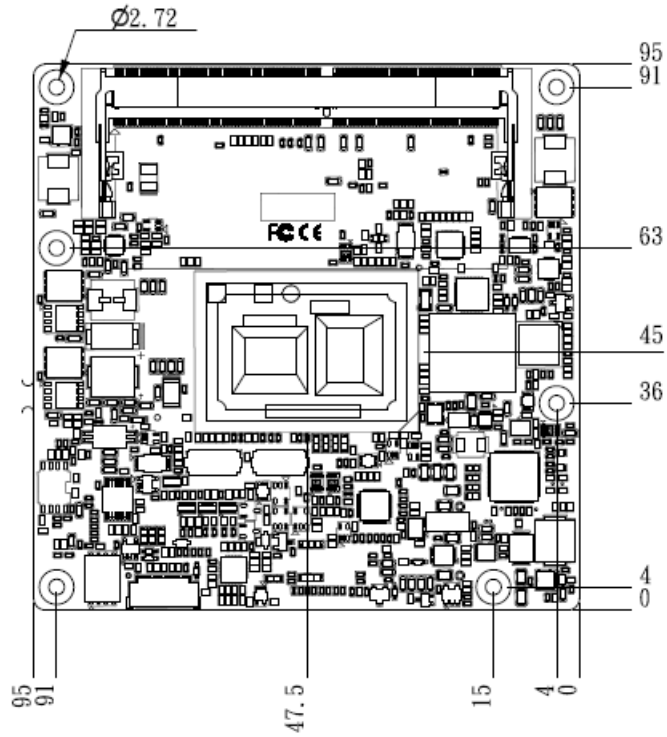
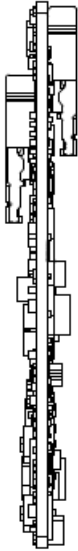
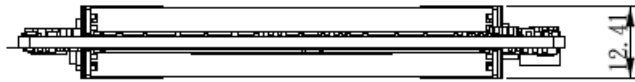

Unit: mm

Wide Temperature

