

EAX-C246BP

**Intel® 8/9th Generation Core™ Processor ATX Motherboard
With Intel® C246 Chipset**

User's Manual

4th Ed – 25 January 2022

FCC Statement



THIS DEVICE COMPLIES WITH PART 15 FCC RULES. OPERATION IS SUBJECT TO THE FOLLOWING TWO CONDITIONS:

- (1) THIS DEVICE MAY NOT CAUSE HARMFUL INTERFERENCE.
- (2) THIS DEVICE MUST ACCEPT ANY INTERFERENCE RECEIVED INCLUDING INTERFERENCE THAT MAY CAUSE UNDESIRE OPERATION.

THIS EQUIPMENT HAS BEEN TESTED AND FOUND TO COMPLY WITH THE LIMITS FOR A CLASS "A" DIGITAL DEVICE, PURSUANT TO PART 15 OF THE FCC RULES.

THESE LIMITS ARE DESIGNED TO PROVIDE REASONABLE PROTECTION AGAINST HARMFUL INTERFERENCE WHEN THE EQUIPMENT IS OPERATED IN A COMMERCIAL ENVIRONMENT. THIS EQUIPMENT GENERATES, USES, AND CAN RADIATE RADIO FREQUENCY ENERGY AND, IF NOT INSTALLED AND USED IN ACCORDANCE WITH THE INSTRUCTION MANUAL, MAY CAUSE HARMFUL INTERFERENCE TO RADIO COMMUNICATIONS.

OPERATION OF THIS EQUIPMENT IN A RESIDENTIAL AREA IS LIKELY TO CAUSE HARMFUL INTERFERENCE IN WHICH CASE THE USER WILL BE REQUIRED TO CORRECT THE INTERFERENCE AT HIS OWN EXPENSE.

Notice

This guide is designed for experienced users to setup the system within the shortest time. For detailed information, please always refer to the electronic user's manual.

Copyright Notice

Copyright © 2022 Avalue Technology Inc., ALL RIGHTS RESERVED.

No part of this document may be reproduced, copied, translated, or transmitted in any form or by any means, electronic or mechanical, for any purpose, without the prior written permission of the original manufacturer.

Trademark Acknowledgement

Brand and product names are trademarks or registered trademarks of their respective owners.

Disclaimer

Avalue Technology Inc. reserves the right to make changes, without notice, to any product, including circuits and/or software described or contained in this manual in order to improve design and/or performance. Avalue Technology assumes no responsibility or liability for the use of the described product(s), conveys no license or title under any patent, copyright, or masks work rights to these products, and makes no representations or warranties that

these products are free from patent, copyright, or mask work right infringement, unless otherwise specified. Applications that are described in this manual are for illustration purposes only. Avalue Technology Inc. makes no representation or warranty that such application will be suitable for the specified use without further testing or modification.

Life Support Policy

Avalue Technology's PRODUCTS ARE NOT FOR USE AS CRITICAL COMPONENTS IN LIFE SUPPORT DEVICES OR SYSTEMS WITHOUT THE PRIOR WRITTEN APPROVAL OF Avalue Technology Inc.

As used herein:

1. Life support devices or systems are devices or systems which, (a) are intended for surgical implant into body, or (b) support or sustain life and whose failure to perform, when properly used in accordance with instructions for use provided in the labeling, can be reasonably expected to result in significant injury to the user.
2. A critical component is any component of a life support device or system whose failure to perform can be reasonably expected to cause the failure of the life support device or system, or to affect its safety or effectiveness.

A Message to the Customer

Avalue Customer Services

Each and every Avalue's product is built to the most exacting specifications to ensure reliable performance in the harsh and demanding conditions typical of industrial environments. Whether your new Avalue device is destined for the laboratory or the factory floor, you can be assured that your product will provide the reliability and ease of operation for which the name Avalue has come to be known.

Your satisfaction is our primary concern. Here is a guide to Avalue's customer services. To ensure you get the full benefit of our services, please follow the instructions below carefully.

Technical Support

We want you to get the maximum performance from your products. So if you run into technical difficulties, we are here to help. For the most frequently asked questions, you can easily find answers in your product documentation. These answers are normally a lot more detailed than the ones we can give over the phone. So please consult the user's manual first.

To receive the latest version of the user's manual; please visit our Web site at:

<http://www.avalue.com.tw/>

Product Warranty

Avalue warrants to you, the original purchaser, that each of its products will be free from defects in materials and workmanship for two years from the date of purchase.

This warranty does not apply to any products which have been repaired or altered by persons other than repair personnel authorized by Avalue, or which have been subject to misuse, abuse, accident or improper installation. Avalue assumes no liability under the terms of this warranty as a consequence of such events. Because of Avalue's high quality-control standards and rigorous testing, most of our customers never need to use our repair service. If any of Avalue's products is defective, it will be repaired or replaced at no charge during the warranty period. For out-of-warranty repairs, you will be billed according to the cost of replacement materials, service time, and freight. Please consult your dealer for more details. If you think you have a defective product, follow these steps:

1. Collect all the information about the problem encountered. (For example, CPU type and speed, Avalue's products model name, hardware & BIOS revision number, other hardware and software used, etc.) Note anything abnormal and list any on-screen messages you get when the problem occurs.
2. Call your dealer and describe the problem. Please have your manual, product, and any helpful information available.
3. If your product is diagnosed as defective, obtain an RMA (return material authorization) number from your dealer. This allows us to process your good return more quickly.
4. Carefully pack the defective product, a complete Repair and Replacement Order Card and a photocopy proof of purchase date (such as your sales receipt) in a shippable container. A product returned without proof of the purchase date is not eligible for warranty service.
5. Write the RMA number visibly on the outside of the package and ship it prepaid to your dealer.

Content

1. Getting Started	9
1.1 Safety Precautions	9
1.2 Packing List.....	9
1.3 Document Amendment History	10
1.4 Manual Objectives.....	11
1.5 System Specifications	12
1.6 Architecture Overview—Block Diagram	15
2. Hardware Configuration	16
2.1 Product Overview.....	17
2.2 Jumper and Connector List.....	18
2.3 Setting Jumpers & Connectors	21
2.3.1 Serial port 3 pin9 signal select (JRI3)	21
2.3.2 Serial port 2 pin9 signal select (JRI2)	21
2.3.3 Serial port 1 pin9 signal select (JRI1)	22
2.3.4 BIOS ME function configuration (JME1)	22
2.3.5 Clear CMOS (JCMOS1).....	23
2.3.6 CPU TDP (Watts) (JCFGID1).....	23
2.3.7 DVI or VGA (JDDI3)	24
2.3.8 AT/ATX Power Mode Select (JSATX1).....	24
2.3.9 General purpose I/O connector (DIO1).....	25
2.3.10 ATX Power connector (ATXPWR1).....	25
2.3.11 Power connector (ATX12V1).....	26
2.3.12 SMBus connector (JSMB1)	26
2.3.13 USB connector (JHUSB1)	27
2.3.14 USB connector (JHUSB2)	27
2.3.15 Battery connector (BAT2).....	28
2.3.16 LPC connector (JLPC1).....	28
2.3.17 Miscellaneous setting connector (SPI1)	29
2.3.18 Speaker connector (SPK1).....	29
2.3.19 Front Panel connector (JFP1)	30
2.3.20 CPU fan connector (CPUFAN1).....	30
2.3.21 System fan connector 1 (SYSFAN1).....	31
2.3.22 External Speaker connector (JBZ1)	31
2.3.23 Auxiliary Panel connector (JAUXP1).....	32
2.3.24 Serial port 2 connector (COM2).....	32
2.3.25 USB connector (JUSB1).....	33

EAX-C246BP User's Manual

2.3.26	USB connector (JUSB3).....	33
2.3.27	J1RS2 connector (J1RS2).....	34
2.3.28	J1RS3 connector (J1RS3).....	34
2.3.29	Audio connector (FAUD1)	35
2.3.30	Auxiliary Fan connector (AUXFAN1).....	35
2.3.31	Serial port connector (4COM1).....	36
2.3.32	Serial port connector (4COM2).....	37
2.3.33	JPC1 connector (JPC1).....	38
3	BIOS Setup	39
3.1	Introduction	40
3.2	Starting Setup	40
3.3	Using Setup	41
3.4	Getting Help.....	42
3.5	In Case of Problems.....	42
3.6	BIOS setup.....	43
3.6.1	Main Menu.....	43
3.6.1.1	System Language.....	44
3.6.1.2	System Date	44
3.6.1.3	System Time.....	44
3.6.2	Advanced Menu	44
3.6.2.1	CPU Configuration.....	45
3.6.2.1.1	CPU - Power Management Control.....	46
3.6.2.2	PCH-FW Configuration	47
3.6.2.2.1	OEM Flags Settings.....	47
3.6.2.2.2	Firmware Update Configuration.....	48
3.6.2.3	Trusted Computing	49
3.6.2.4	ACPI Settings	49
3.6.2.5	Super IO Configuration	50
3.6.2.5.1	Serial Port 1 Configuration	51
3.6.2.5.2	Serial Port 2 Configuration	51
3.6.2.5.3	Serial Port 3 Configuration	52
3.6.2.5.4	Serial Port 4 Configuration	52
3.6.2.5.5	Serial Port 5 Configuration	53
3.6.2.5.6	Serial Port 6 Configuration	53
3.6.2.5.7	Serial Port 7 Configuration	54
3.6.2.5.8	Serial Port 8 Configuration	54
3.6.2.5.9	Serial Port 9 Configuration	55
3.6.2.5.10	Serial Port 10 Configuration	55
3.6.2.6	NCT6106D H/W Monitor.....	56
3.6.2.6.1	Smart Fan Configuration	56

3.6.2.7	S5 RTC Wake Settings.....	58
3.6.2.8	Serial Port Console Redirection	58
3.6.2.9	USB Configuration.....	59
3.6.2.10	NVMe Configuration	60
3.6.2.11	Network Stack Configuration.....	60
3.6.3	Chipset	61
3.6.3.1	System Agent (SA) Configuration.....	61
3.6.3.1.1	Memory Configuration	62
3.6.3.1.2	Graphics Configuration.....	63
3.6.3.1.3	DMI/OPI Configuration	63
3.6.3.1.4	PEG Port Configuration	64
3.6.3.1.4.1	PEG Port Feature Configuration.....	65
3.6.3.2	PCH-IO Configuration.....	66
3.6.3.2.1	PCI Express Configuration	66
3.6.3.2.1.1	PCI Express Slot 1 (PCI-E Port 5~8).....	67
3.6.3.2.1.2	PCI Express Slot 2 (PCI-E Port 9~12).....	68
3.6.3.2.1.3	PCI Express Slot 3 (PCI-E Port 21~24).....	69
3.6.3.2.1.4	Intel I211/I210 LAN Chip (PCI-E Port 14).....	70
3.6.3.2.1.5	PCIE to PCI (PCI-E Port 19).....	71
3.6.3.2.1.6	PCIE to USB3.0 (PCI-E Port 20)	72
3.6.3.2.1	SATA And RST Configuration	73
3.6.3.2.3	HD Audio Configuration	74
3.6.3.3	Board Configuration.....	74
3.6.4	Security.....	75
3.6.4.1	Secure Boot	76
3.6.4.1.1	Restore Factory Keys	77
3.6.4.1.2	Key Management.....	77
3.6.5	Boot	79
3.6.6	Save & Exit.....	80
3.6.5.1	Save Changes and Reset.....	80
3.6.5.2	Discard Changes and Reset.....	80
3.6.5.3	Restore Defaults	81
3.6.5.4	Launch EFI Shell from filesystem device	81
4.	Drivers Installation.....	82
4.1	Install Chipset Driver	83
4.2	Install VGA Driver.....	84
4.3	Install ME Driver.....	85
4.4	Install Audio Driver (For Realtek ALC888S HD Audio).....	86
4.5	Install LAN Driver	87
4.6	Install RST Driver	89

EAX-C246BP User's Manual

4.7 Install Serial IO Driver91

5. Mechanical Drawing92

1. Getting Started

1.1 Safety Precautions

Warning!



Always completely disconnect the power cord from your chassis whenever you work with the hardware. Do not make connections while the power is on. Sensitive electronic components can be damaged by sudden power surges. Only experienced electronics personnel should open the PC chassis.

Caution!



Always ground yourself to remove any static charge before touching the CPU card. Modern electronic devices are very sensitive to static electric charges. As a safety precaution, use a grounding wrist strap at all times. Place all electronic components in a static-dissipative surface or static-shielded bag when they are not in the chassis.

1.2 Packing List

Before you begin installing your single board, please make sure that the following materials have been shipped:

- 1 x EAX-C246BP motherboard
- 2 x SATA cables
- 1 x I/O Shield



If any of the above items is damaged or missing, contact your retailer.

1.3 Document Amendment History

Revision	Date	By	Comment
1 st	September 2020	Avalue	Initial Release
2 nd	April 2021	Avalue	Update Jumper and Connector
3 rd	July 2021	Avalue	Update Jumper and Connector
4 th	January 2022	Avalue	Update System Specifications

1.4 Manual Objectives

This manual describes in details Avalue Technology EAX-C246BP Single Board.

We have tried to include as much information as possible but we have not duplicated information that is provided in the standard IBM Technical References, unless it proved to be necessary to aid in the understanding of this board.

We strongly recommend that you study this manual carefully before attempting to set up EAX-C246BP or change the standard configurations. Whilst all the necessary information is available in this manual we would recommend that unless you are confident, you contact your supplier for guidance.

Please be aware that it is possible to create configurations within the CMOS RAM that make booting impossible. If this should happen, clear the CMOS settings, (see the description of the Jumper Settings for details).

If you have any suggestions or find any errors regarding this manual and want to inform us of these, please contact our Customer Service department with the relevant details.

1.5 System Specifications

System	
CPU	Intel® 8/9th Gen Supports LGA 1151 CPU Up to 95W Max
BIOS	AMI uEFI BIOS, 256Mbit SPI Flash ROM
System Chipset	Intel® C246 Express Chipset
I/O Chip	Nuvoton® NCT6106D
System Memory	Four 288-pin DDR4 2400/2666MHz DIMM socket, supports up to 128GB Max
Watchdog Timer	5~255 seconds/5~255 minutes
H/W Status Monitor	CPU temperature monitoring Voltages monitoring CPU fan speed control
RAID	Support RAID 0, 1, 5, 10
TPM	Onboard Infineon SLB9665 support TPM 2.0
iAMT	Yes, by CPU
Expansion Slot	
PCIe	2 x PCI-e x16 slot for 1 x PCI-e x16 or 2 x PCI-e x8 (By Auto switch IC) 3 x PCI-e x4
PCI	1 x PCI
I/O Specification	
USB	7 x USB 3.0, 4 x USB 3.1 Gen2, 2 x USB 2.0
GPIO	16-bit GPIO
Edge I/O	
COM	1 x COM connector
LAN	1 x Intel® I219LM Gigabit Ethernet PHY 1 x Intel® I210AT PCI-e Gigabit Ethernet and co-layout I211AT PCI-e Gigabit Ethernet
USB 3.1	PS/2 KB/MS + 2 x USB 3.1 GEN 2, 2 x RJ-45 with Dual deck for 4 x USB 3.1 GEN 2 connector at I/O 4 x USB 3.1 GEN 1 at I/O
DP	DP++, DP++
DVI	DVI-I
Onboard I/O	
COM	COM 1 by DB9 Connector at IO support RS-232 COM 2~3: Support RS232/422/485 selected by BIOS selection 3 x 2 x 3 pin, pitch 2.00mm connector for COM 1~3 support RS232 with Pin 9,+5V/+12V/RI by jumper 2 x 2 x 3 pin, pitch 2.00mm connector for COM 2~3 support RS422/485 connector,

	Pin 5 with +5V 1 x 2 x 5 pin, pitch 2.00mm connector for COM 2 support RS-232 connector COM 3~6 1 x 2 x 20 pin, pitch 2.00mm connector for COM 3~6 support RS-232 connector COM 7~10 1 x 2 x 20 pin, pitch 2.00mm connector for COM 7~10: support RS-232 connector
USB 2.0	1 x 1 x 5 pin, pitch 2.54mm connector for 1 x USB 2.0 1 x 2 x 5 pin, pitch 2.54mm connector for 2 x USB 2.0 1 x USB 2.0 By Vertical type A connector
USB 3.1	2 x 2 x 10 pin, pitch 2.0mm connector for 4 x USB 3.1 GEN 1(using PCI-e to USB3.1 Gen 1 by BOM optional)
GPIO	1 x 2 x 10 pin, pitch 2.00mm connector for GPIO: 16 bits & +5VS Level SMBus
CPU/System FAN	1 x 1 x 4 pin, pitch 2.54mm CPU fan connector with smart fan function supported 1 x 1 x 4 pin, pitch 2.54mm System fan connector with smart fan function supported
Buzzer	1 x 4 pin, pitch 2.54mm connector for Speaker Buzzer
Front Panel	1 x 2 x 5 pin, pitch 2.54mm connector for front panel
RTC Battery	1 x Horizontal type battery connector Co-lay 1 x 2 Pin Pitch 1.25mm horizontal type battery connector
AT/ATX Selector	1 x 1 x 3 pin pitch 2.00mm connector for AT/ATX jumper 1 x 2 x 12 pin ATX power connector 1 x 2 x 4 pin ATX 12V power connector
Clear CMOS	1 x 1 x 3pin, pitch 2.54mm connector for COMS Clear
LPC	2 x 2 x 5 pin, pitch 2.0mm connector for LPC
BIOS SPI	1 x 2 x 4 pin, pitch 2.00mm connector for BIOS SPI
Audio	1 x 2 x 5 pin, pitch 2.54mm connector for front Audio
Amp Connector	1 x 4 pin, pitch wafer 2.00mm connector for 6W x 2 Speaker
Other	1 x 2 x 5 pin, pitch 2.54mm connector for JME
Display	
Graphic Chipset	Intel® C246 Express chipset
Spec. & Resolution	DVI-I: 1920 x 1080 @ 60 Hz 2 x DP++: 4096 x 2304@60Hz
Multiple Display	Triple Display
Audio	
Audio Codec	Realtek ALC888S HD Audio Decoding Controller
Amplifier	6W Amplifier
Ethernet	
LAN Chipset	1 x Intel® I219LM Gigabit Ethernet PHY 1 x Intel® I210AT PCI-e Gigabit Ethernet and co-layout I211AT PCI-e Gigabit Ethernet

Mechanical & Environmental Specification	
Power Requirement	+12V / +5V / 5VSB /+3.3V / -12V
ACPI	Single power ATX Support S0, S3, S4, S5
Power Mode	AT/ATX mode
Operating Temp.	0~60°C (32~140°F), w/HDD/SSD, ambient with 0.5 m/s Air flow
Storage Temp.	-40~ 75°C
Operating Humidity	40°C @ 95% Relative Humidity, Non-condensing
Size (L x W)	12" x 9.6" (304.8mm x 243.84mm)
Weight	0.60 kg



Note: Specifications are subject to change without notice.

1.6 Architecture Overview—Block Diagram

The following block diagram shows the architecture and main components of EAX-C246BP.

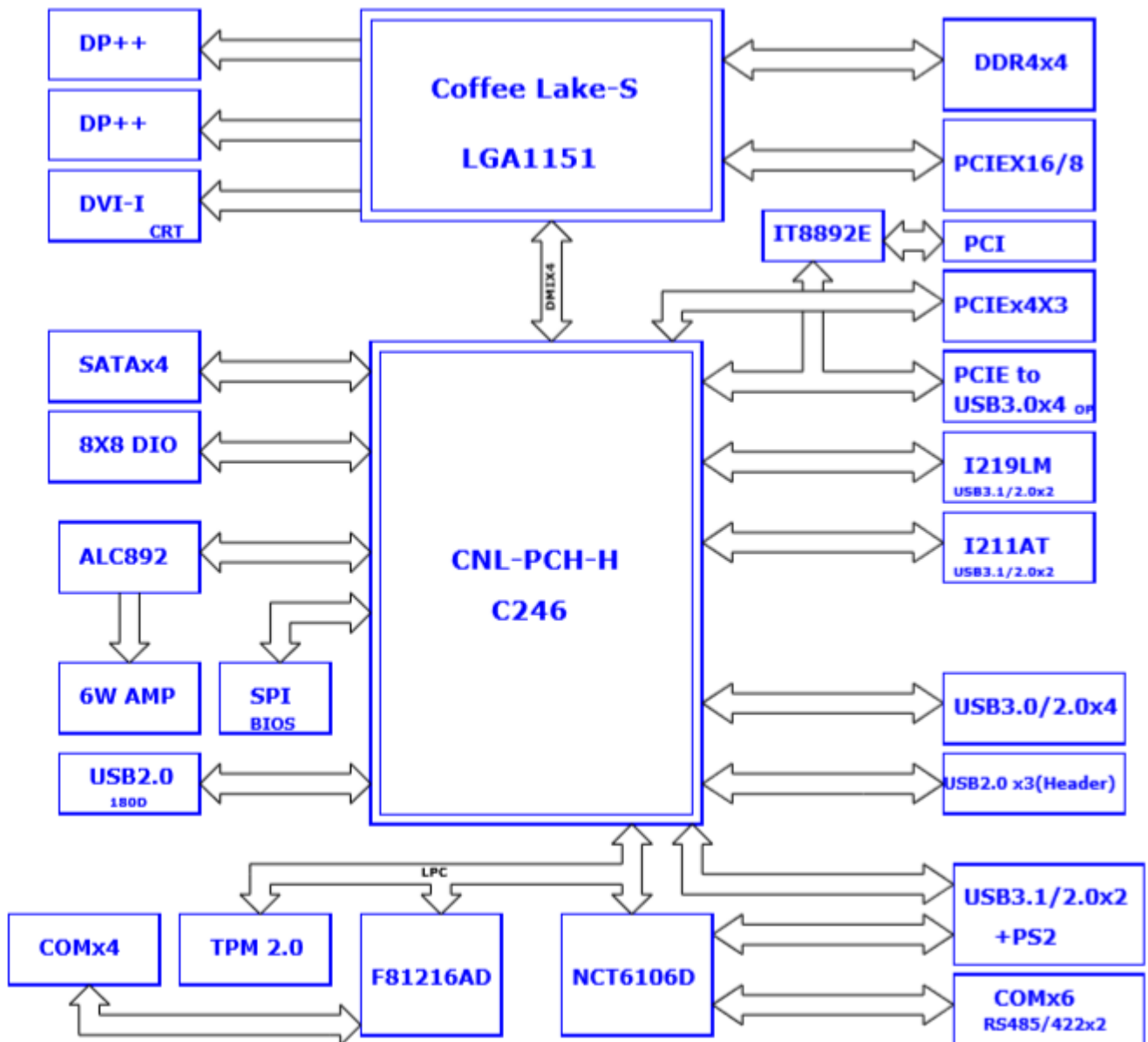

2. Hardware Configuration

2.1 Product Overview

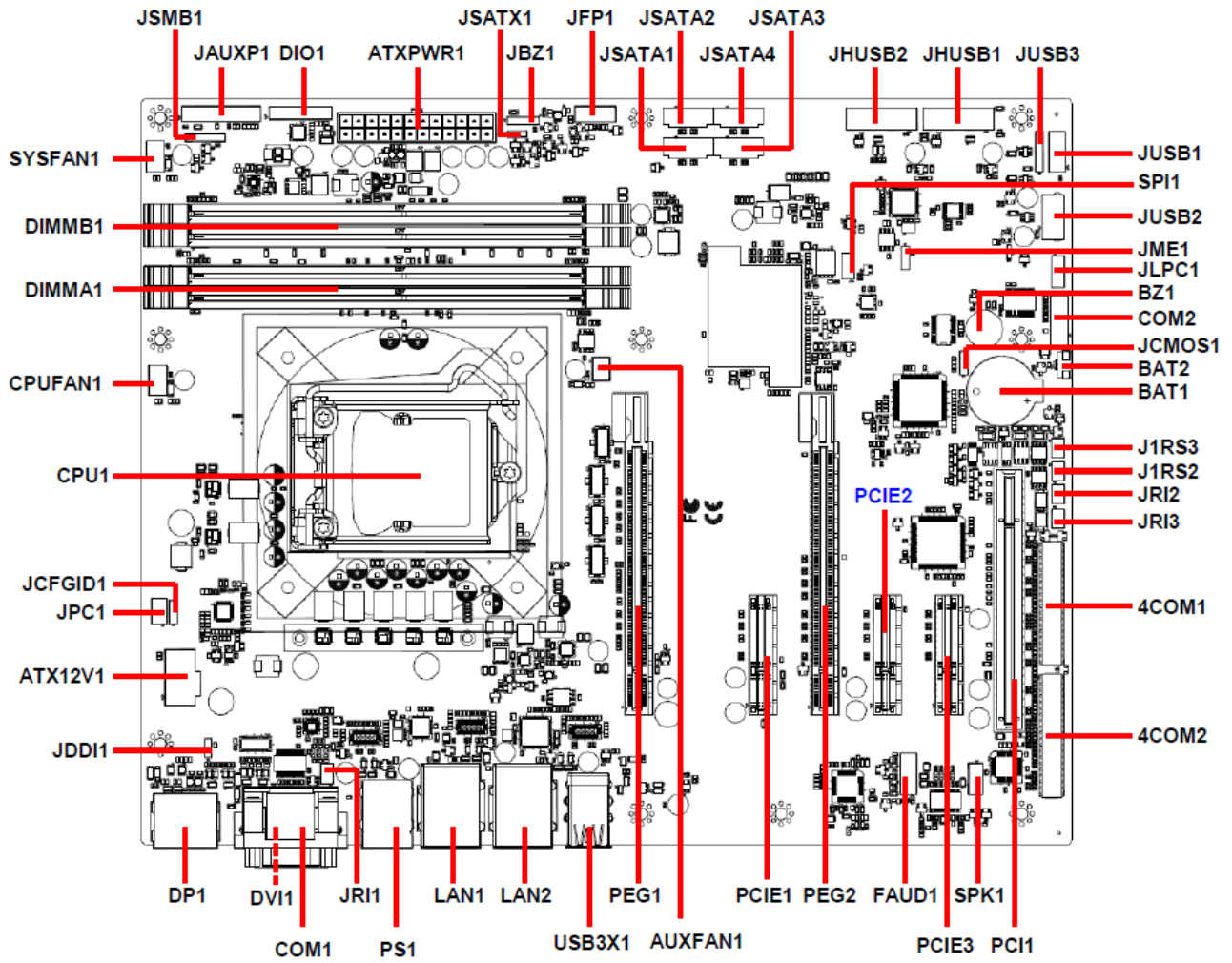

2.2 Jumper and Connector List

You can configure your board to match the needs of your application by setting jumpers. A jumper is the simplest kind of electric switch.

It consists of two metal pins and a small metal clip (often protected by a plastic cover) that slides over the pins to connect them. To “close” a jumper you connect the pins with the clip. To “open” a jumper you remove the clip. Sometimes a jumper will have three pins, labeled 1, 2, and 3. In this case, you would connect either two pins.

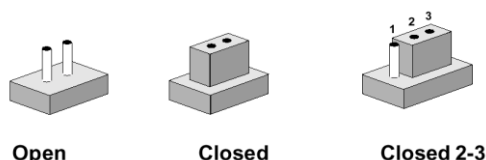

The jumper settings are schematically depicted in this manual as follows:



A pair of needle-nose pliers may be helpful when working with jumpers.

Connectors on the board are linked to external devices such as hard disk drives, a keyboard, or floppy drives. In addition, the board has a number of jumpers that allow you to configure your system to suit your application.

If you have any doubts about the best hardware configuration for your application, contact your local distributor or sales representative before you make any changes.

The following tables list the function of each of the board's jumpers and connectors.

Jumpers

Label	Function	Note
JRI1/2/3	Serial port 1/2/3 pin9 signal select	3 x 2 header, pitch 2.00mm
JME1	BIOS ME function configuration	3 x 1 header, pitch 2.54mm
JSATX1	AT/ATX Power Mode Select	3 x 1 header, pitch 2.00mm
JCMOS1	Clear CMOS	3 x 1 header, pitch 2.54mm
JCFGID1	CPU TDP (Watts)	3 x 1 header, pitch 2.54mm
JDDI3	DVI or VGA	3 x 1 header, pitch 2.00mm

Connectors

Label	Function	Note
CPUFAN1	CPU fan connector	4 x 1 wafer, pitch 2.54mm
SYSFAN1	System fan connector 1 (with smart fan function supported)	4 x 1 wafer, pitch 2.54mm

JFP1	Front Panel connector	5 x 2 header, pitch 2.54 mm
DIMMA1	240-pin DIMM slot 1	
DIMM/B1	240-pin DIMM slot 2	
JSMB1	SMBus connector	5 x 1 header, pitch 2.54 mm
JAUXP1	Auxiliary Panel connector	10 x 2 header, pitch 2.54 mm
SPI1	Miscellaneous setting connector	4 x 2 header, pitch 2.00mm
FAUD1	Audio connector	5 x 2 header, pitch 2.54mm
COM1	Serial Port1 connector	
COM2	Serial Port2 connector	5 x 2 header, pitch 2.00 mm
4COM1/2	Serial Port connector	20 x 2 header, pitch 2.00mm
JBZ1	External Speaker connector	4 x 1 header, pitch 2.54 mm
DIO1	General purpose I/O connector	10 x 2 header, pitch 2.00mm
SPK1	Speaker connector	1 x 4 wafer, pitch 2.00 mm
LAN1/2	2 x RJ-45 with Dual deck USB 3.0 connector	
BZ1	Buzzer	
PS1	PS2+USB connector	
JHUSB1/2	USB connector	10 x 2 wafer, pitch 2.00mm
USB3X1	USB connector	
JUSB1	USB connector	
JUSB2	USB connector	
JUSB3	USB connector	5 x 1 header, pitch 2.54mm
J1RS2	J1RS2 connector	3 x 2 header, pitch 2.00 mm
J1RS3	J1RS3 connector	3 x 2 header, pitch 2.00 mm
JLPC1	LPC connector	5 x 2 header, pitch 2.00mm
PCIE1/2/3	PCIe slot 1/2/3	
PCI1	PCI slot 1	
BAT1	Battery connector	
BAT2	Battery connector	2 x 1 wafer, pitch 1.25mm
AUXFAN1	Auxiliary Fan connector	3 x 1 wafer, pitch 2.54mm
ATXPWR1	ATX Power connector	12 x 2 wafer, pitch 4.20mm
ATX12V1	Power connector	2 x 4 wafer, pitch 4.20mm
JSATA1/2/3/4	Serial ATA connector 1/2/3/4	
CPU	CPU connector	
DP1	DP connector	
DVI1	DVI1 connector	

EAX-C246BP User's Manual

PEG1/2

PCI-e x16 slots

JPC1

JPC1 connector

3 x 2 header, pitch 2.00 mm

2.3 Setting Jumpers & Connectors

2.3.1 Serial port 3 pin9 signal select (JRI3)

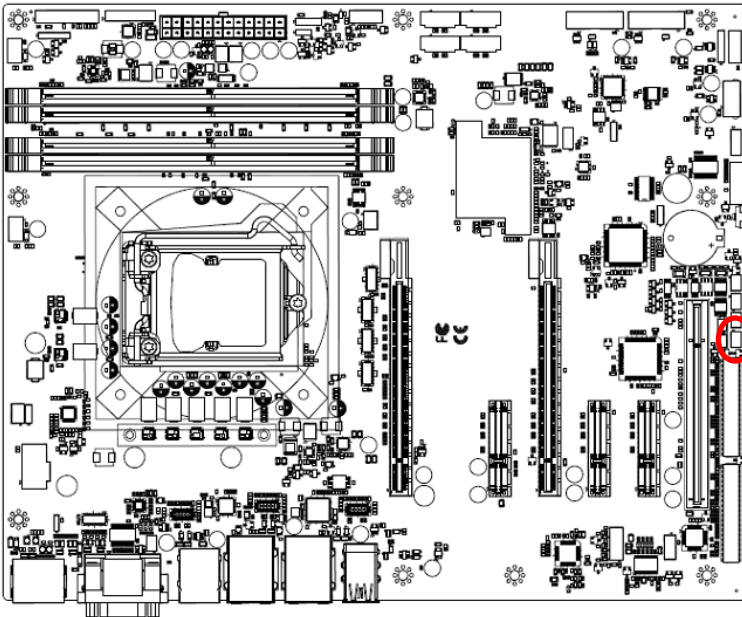

Ring*

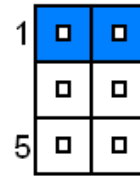

+5V

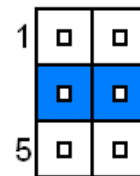

+12V

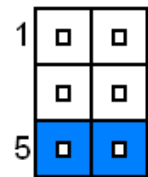

* Default

2.3.2 Serial port 2 pin9 signal select (JRI2)

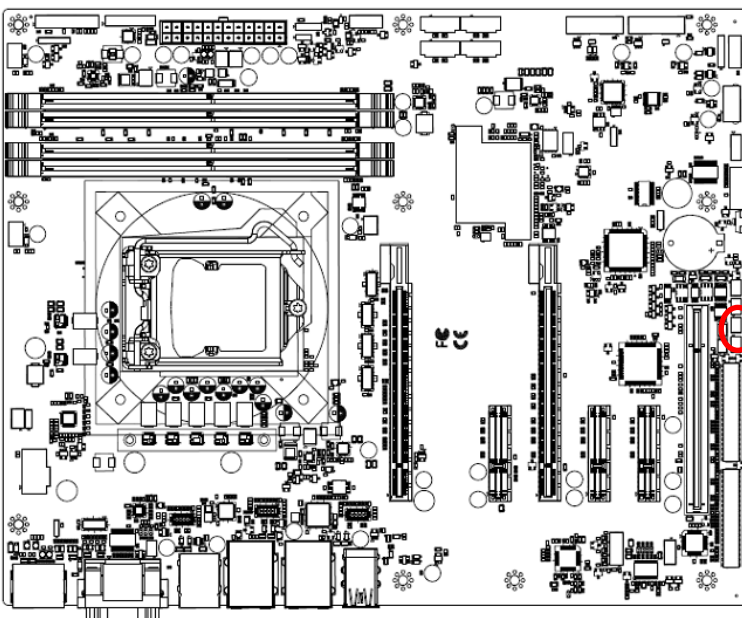

Ring*

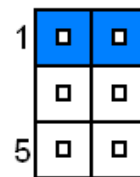

+5V

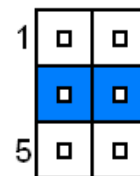

+12V

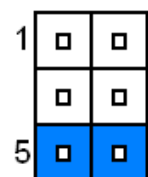

* Default

2.3.3 Serial port 1 pin9 signal select (JRI1)

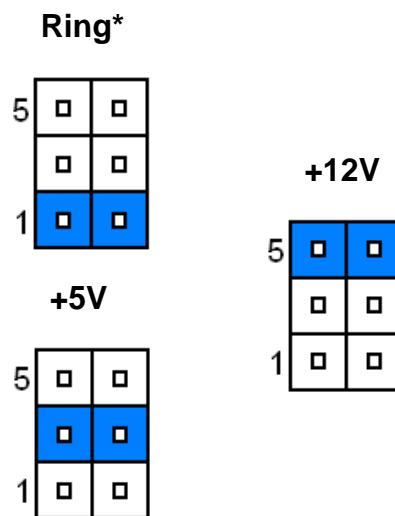
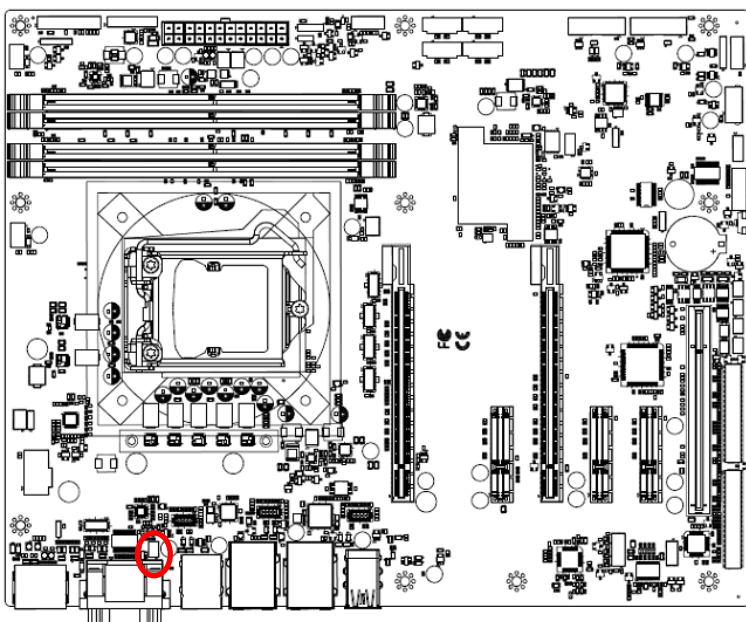

* Default

2.3.4 BIOS ME function configuration (JME1)

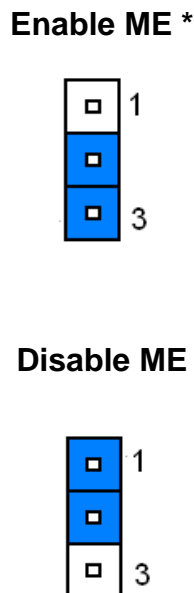
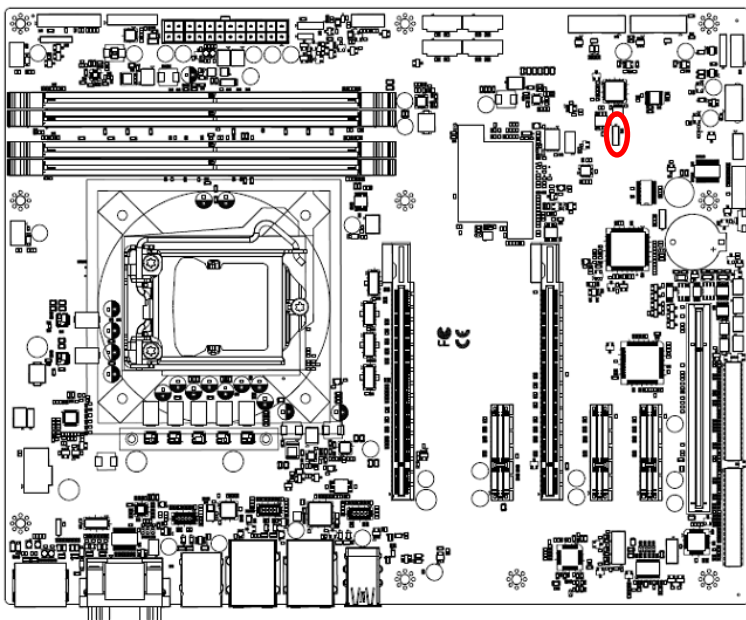

* Default

2.3.5 Clear CMOS (JCMOS1)

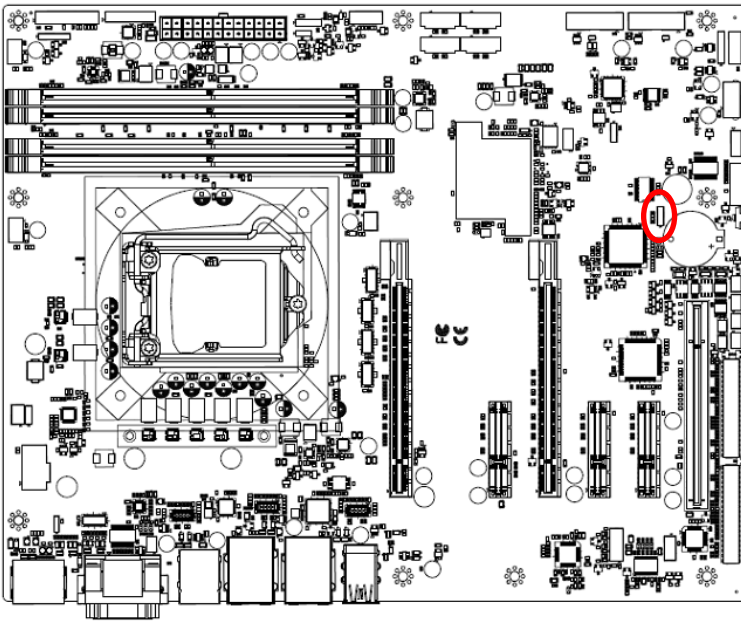

Protect*

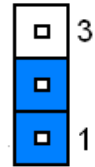

Clear CMOS

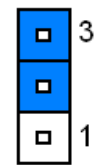

* Default

2.3.6 CPU TDP (Watts) (JCFGID1)

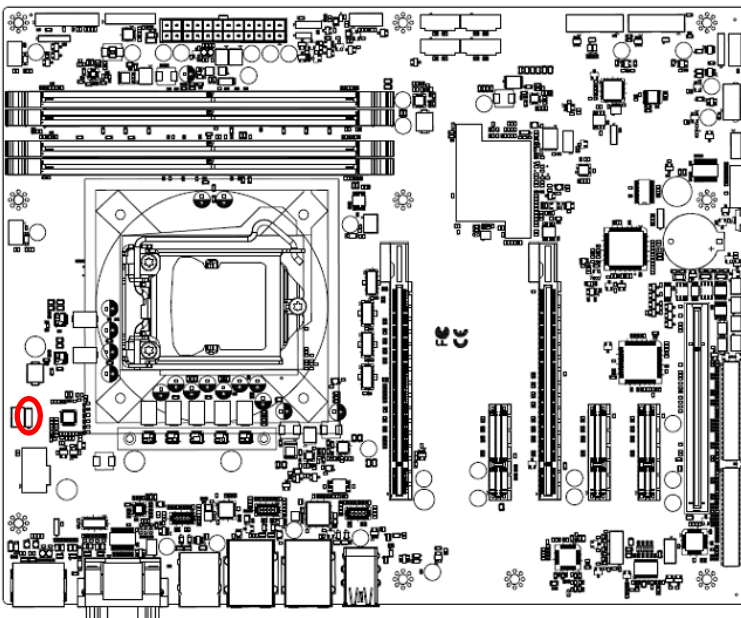

Config ID1 *

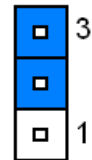

Config ID0

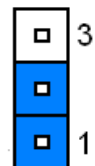

* Default



Note: Config ID0: JCFGID1(1-2) (For debug only)

Config ID1: JCFGID1(2-3) For CPU Power FW setting (Default).

2.3.7 DVI or VGA (JDDI3)

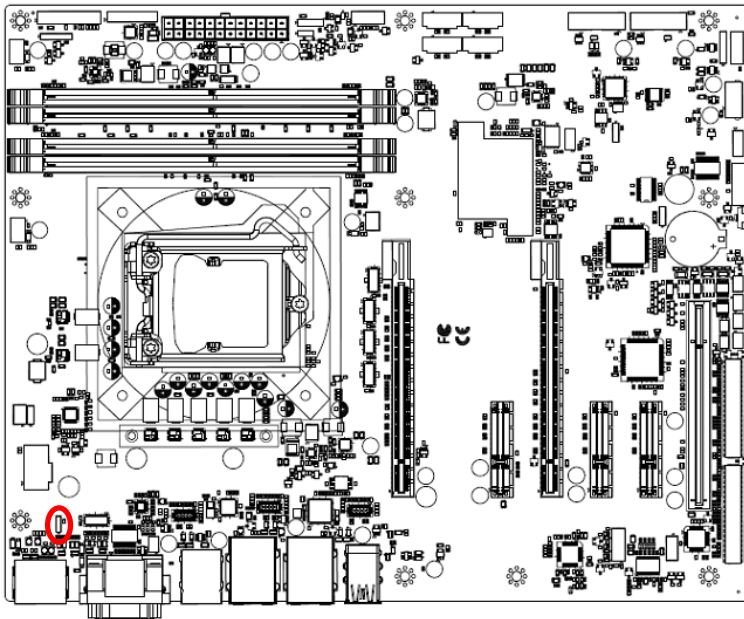

CRT

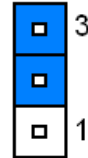

DVI*

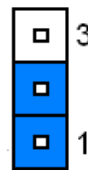

* Default

2.3.8 AT/ATX Power Mode Select (JSATX1)

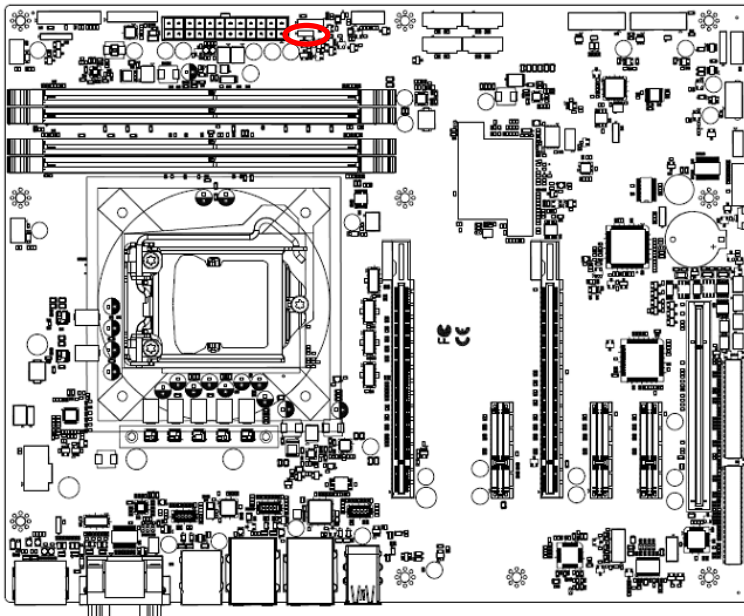

ATX*

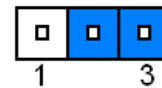

AT

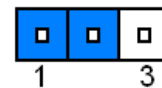

* Default

2.3.9 General purpose I/O connector (DIO1)

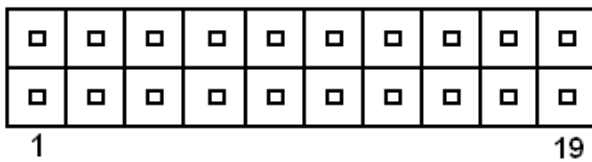
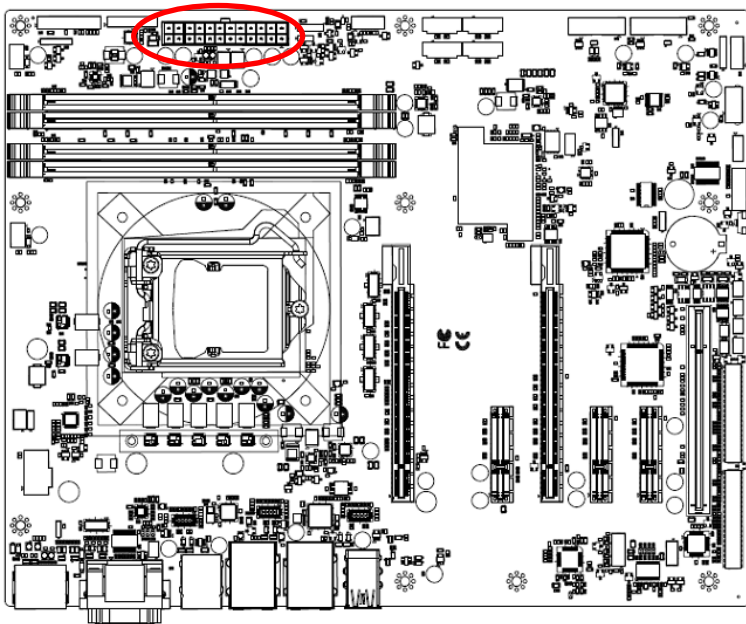

Signal	PIN	PIN	Signal
DI0	1	2	DO0
DI1	3	4	DO1
DI2	5	6	DO2
DI3	7	8	DO3
DI4	9	10	DO4
DI5	11	12	DO5
DI6	13	14	DO6
DI7	15	16	DO7
5V_SMB_CLK	17	18	5V_SMB_DATA
GND	19	20	+5V

2.3.10 ATX Power connector (ATXPWR1)

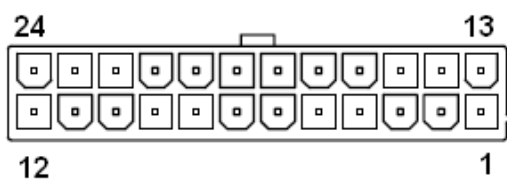
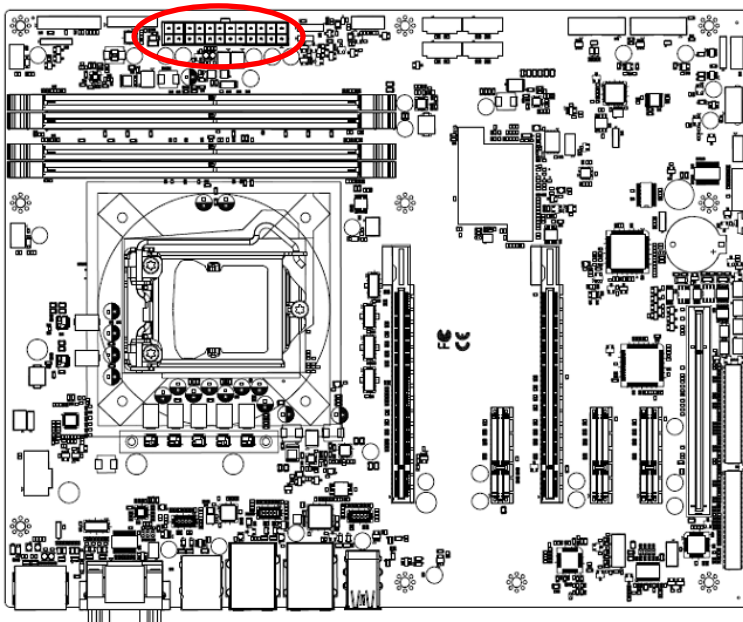

Signal	PIN	PIN	Signal
+3.3V	1	13	+3.3V
+3.3V	2	14	-12V
GND	3	15	GND
+5V	4	16	ATX_PSON#
GND	5	17	GND
+5V	6	18	GND
GND	7	19	GND
ATX24_PWROK	8	20	NC
+V5SB	9	21	+5V
+12V	10	22	+5V
+12V	11	23	+5V
+3.3V	12	24	GND

2.3.11 Power connector (ATX12V1)

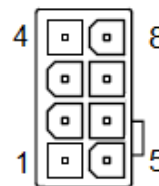
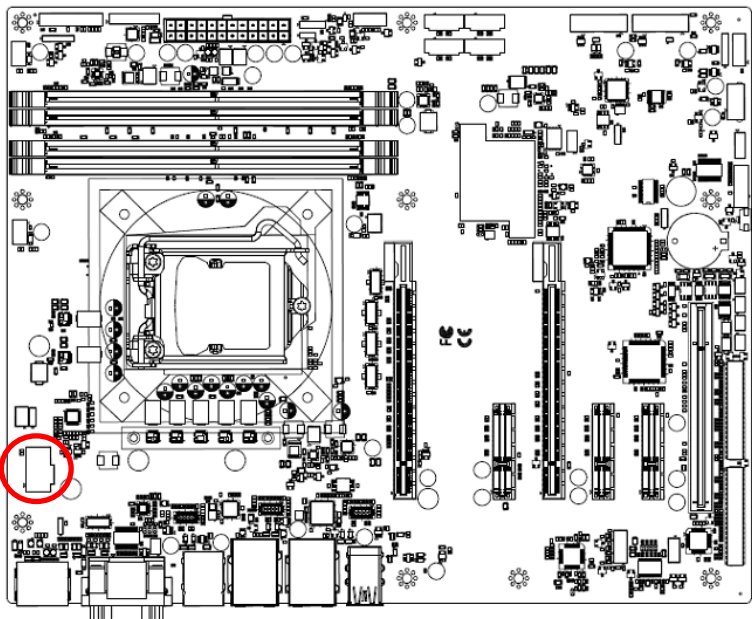

Signal	PIN	PIN	Signal
GND/Detect	4	8	+V12S_CPU
GND	3	7	+V12S_CPU
GND	2	6	+V12S_CPU
GND	1	5	+V12S_CPU

2.3.12 SMBus connector (JSMB1)

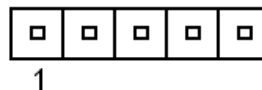
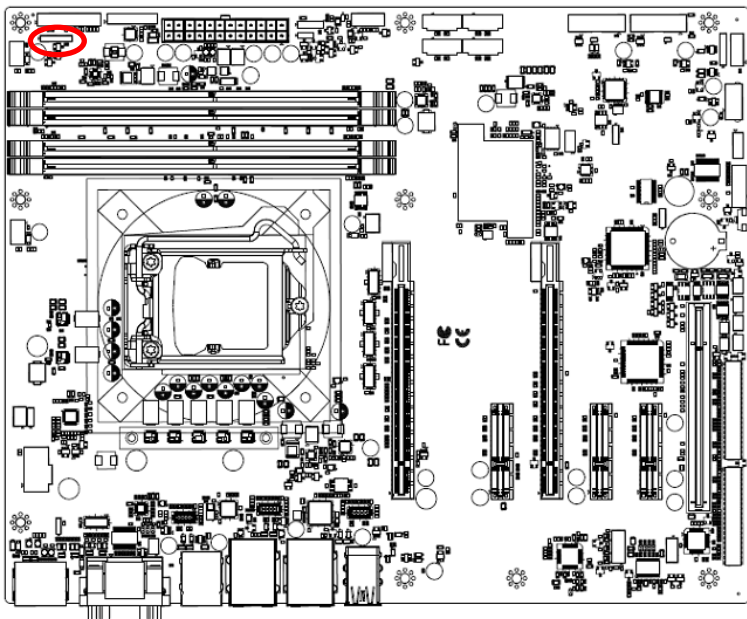

Signal	PIN
SMB_CLK	1
SMB_DATA	2
SMB_ALERT#	3
GND	4
+3.3V	5

2.3.13 USB connector (JHUSB1)

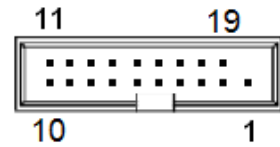
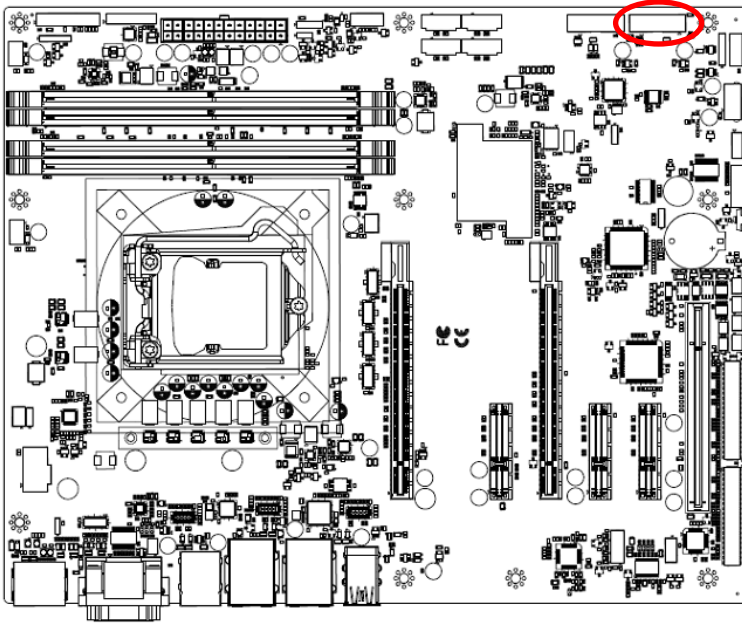

Signal	PIN	PIN	Signal
		1	+V5A_USB1
GND	19	2	USB30H_RX_N1
USB30H_RX_N2	18	3	USB30H_RX_P1
USB30H_RX_P2	17	4	GND
GND	16	5	USB30H_TXN1
USB30H_TXN2	15	6	USB30H_TXP1
USB30H_TXP2	14	7	GND
GND	13	8	USB20H_DN1
USB20H_DN2	12	9	USB20H_DP1
USB20H_DP2	11	10	NC

2.3.14 USB connector (JHUSB2)

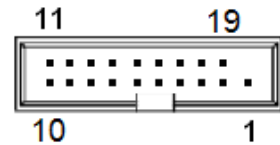
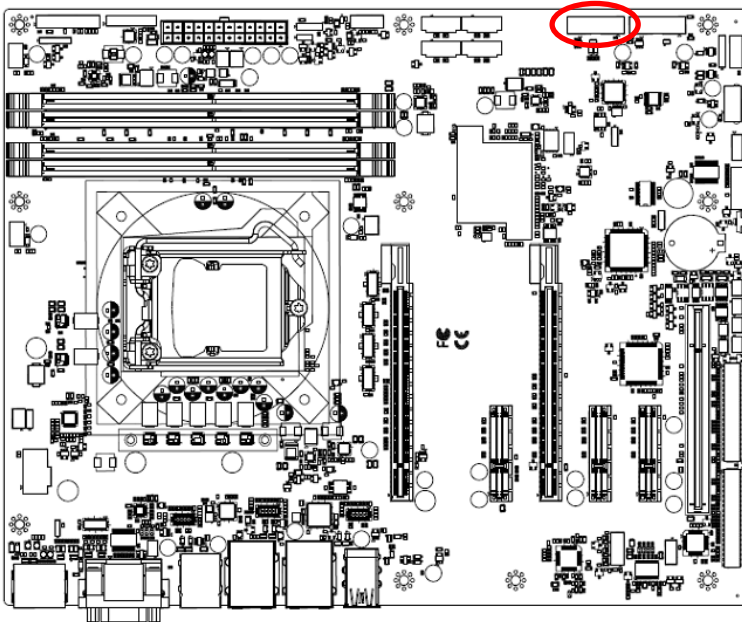

Signal	PIN	PIN	Signal
		1	+V5A_USB2
GND	19	2	USB30H_RX_N3
USB30H_RX_N4	18	3	USB30H_RX_P3
USB30H_RX_P4	17	4	GND
GND	16	5	USB30H_TXN3
USB30H_TXN4	15	6	USB30H_TXP3
USB30H_TXP4	14	7	GND
GND	13	8	USB20H_DN3
USB20H_DN4	12	9	USB20H_DP3
USB20H_DP4	11	10	NC

2.3.15 Battery connector (BAT2)

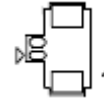
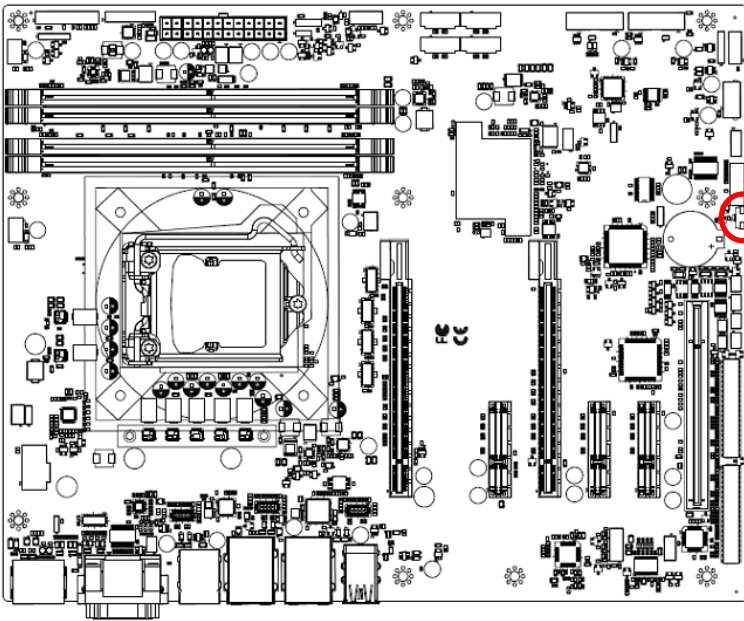

Signal	PIN
GND	1
+3.3V	2

2.3.16 LPC connector (JLPC1)

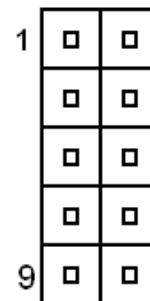
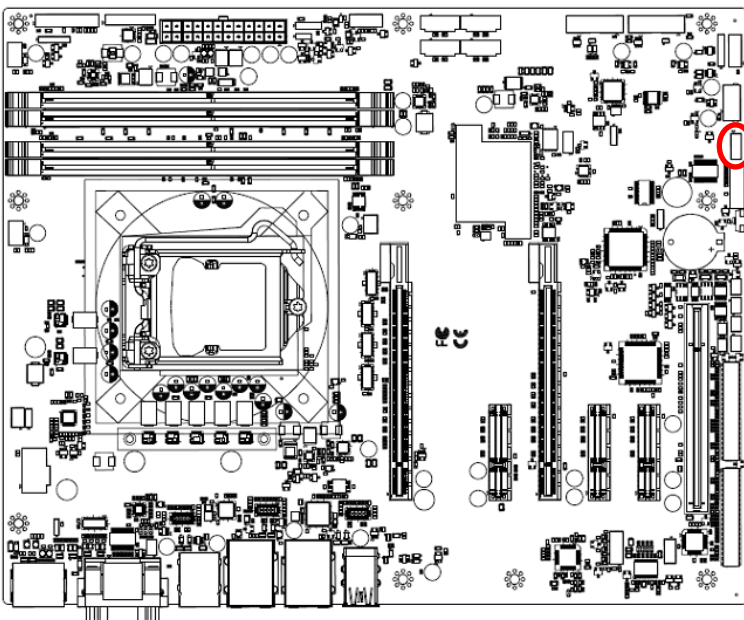

Signal	PIN	PIN	Signal
LPC_AD0	1	2	+3.3V
LPC_AD1	3	4	PLT_RST#_BUF
LPC_AD2	5	6	LPC_FRAME#
LPC_AD3	7	8	LPC_DEG_CLK
LPC_SERIRQ	9	10	GND

2.3.17 Miscellaneous setting connector (SPI1)

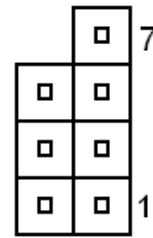
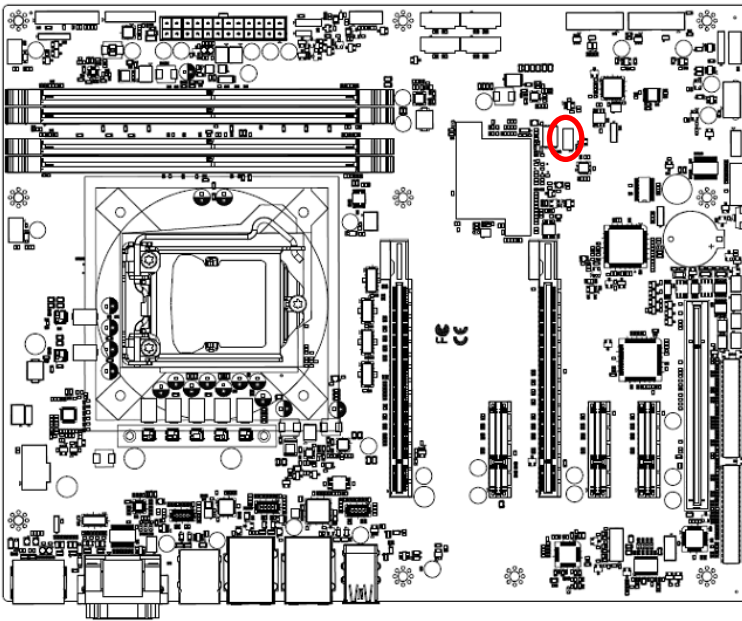

Signal	PIN	PIN	Signal
		7	SPI_HOLD#
SPI_MOSI	6	5	SPI_MISO
SPI_CLK	4	3	SPI_CS0#
GND	2	1	+ V 3.3A_SPI

2.3.18 Speaker connector (SPK1)

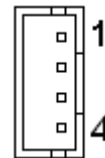
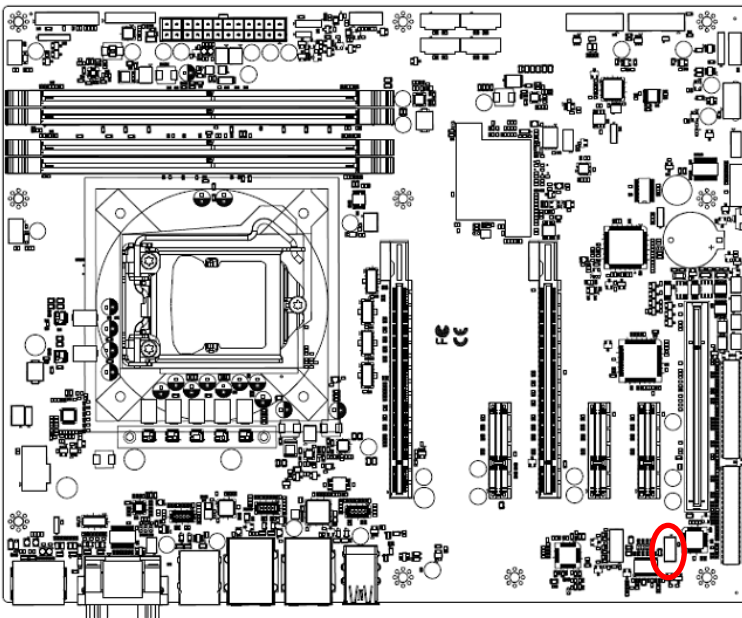

Signal	PIN
LSPK+	1
LSPK-	2
RSPK+	3
RSPK-	4

2.3.19 Front Panel connector (JFP1)

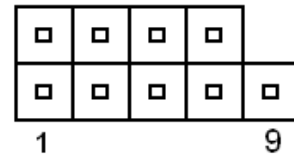
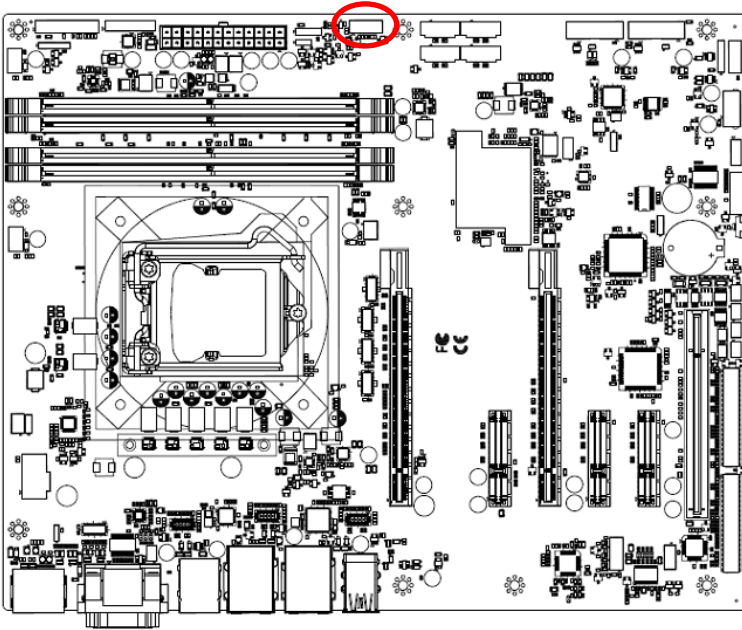

Signal	PIN	PIN	Signal
HDD_LED+	1	2	PWR_LED+
HDD_LED-	3	4	PWR_LED-
SYS_RST#	5	6	PWRBTN#
GND	7	8	GND
NC	9		

2.3.20 CPU fan connector (CPUFAN1)

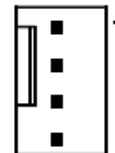
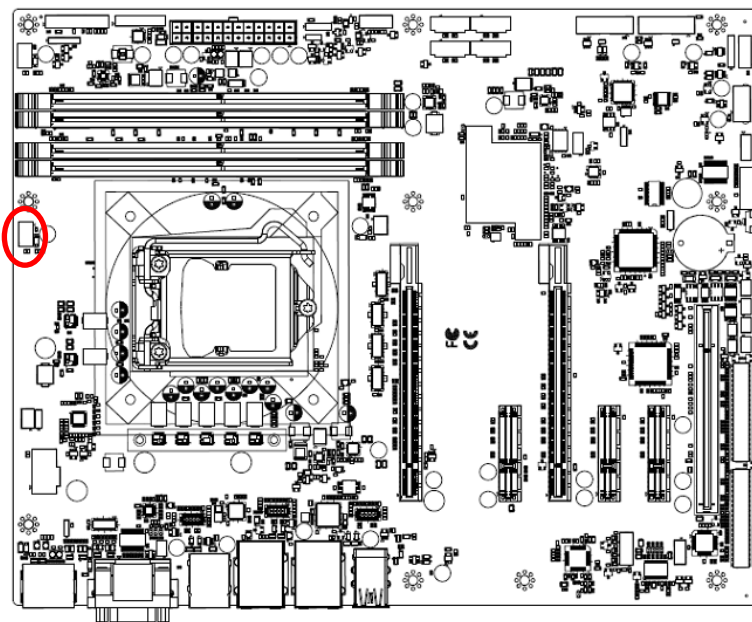

Signal	PIN
GND	1
+12V	2
CPU_R_FANIN	3
CPU_FANOUT	4

2.3.21 System fan connector 1 (SYSFAN1)

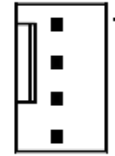
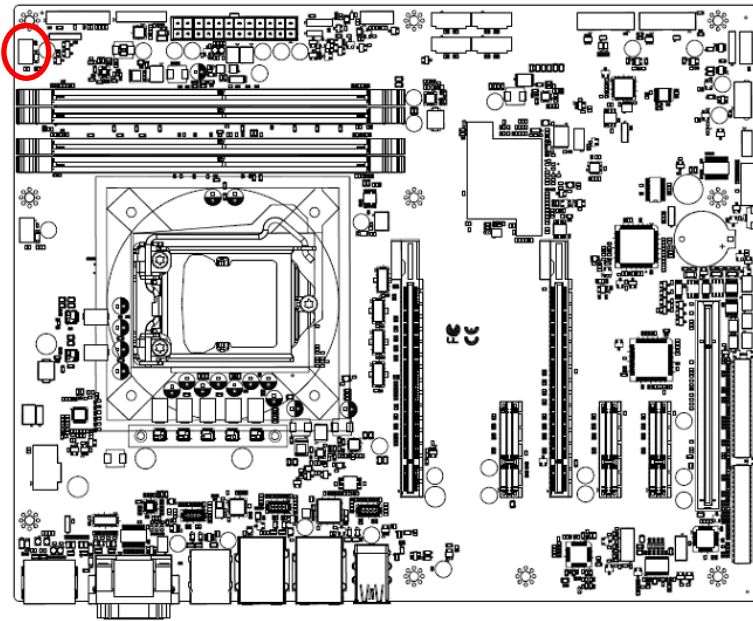

Signal	PIN
GND	1
+12V	2
SYS_R_FANIN	3
SYS_FANOUT	4

2.3.22 External Speaker connector (JBZ1)

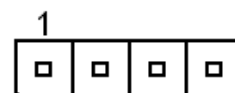
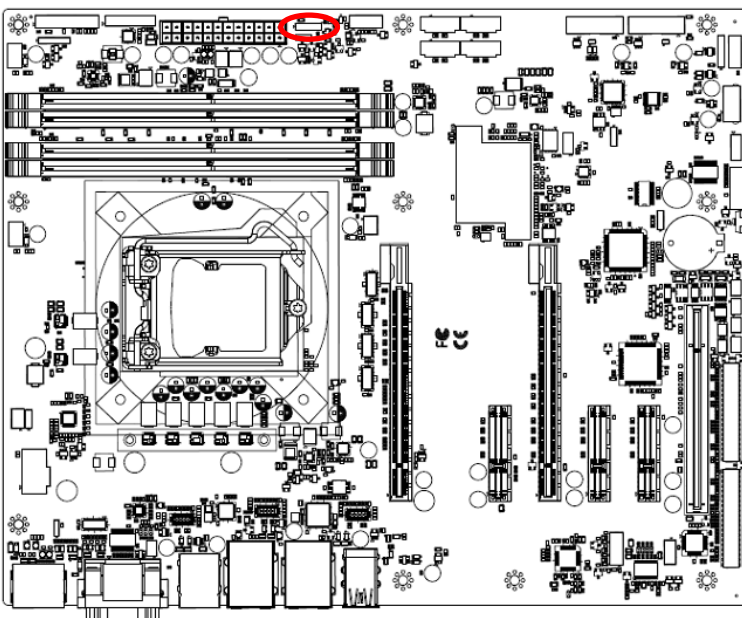

Signal	PIN
+5V	1
NC	2
NC	3
GND	4

2.3.23 Auxiliary Panel connector (JAUXP1)

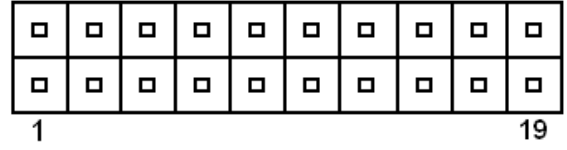
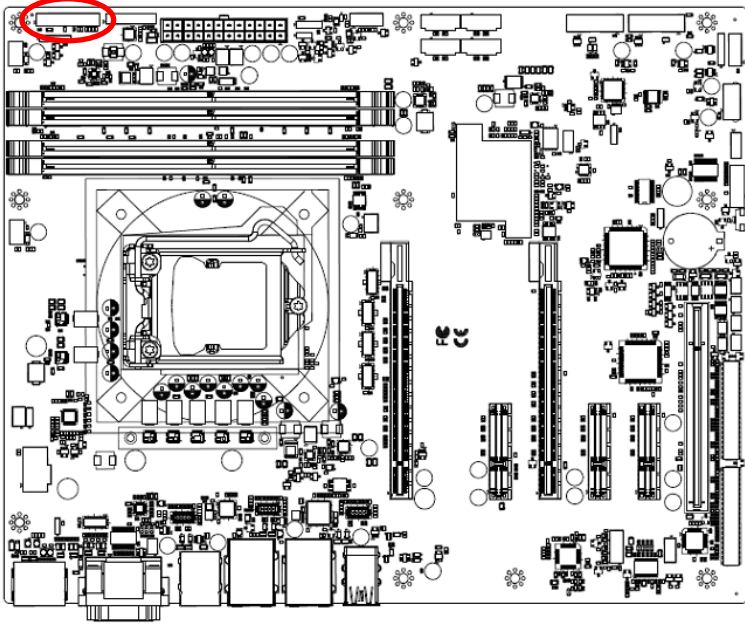

Signal	PIN	PIN	Signal
+5V	1	2	NC
NC	3	4	SMB_CLK
CASEOPEN#	5	6	NC
GND	7	8	GND
ERROR_LED+	9	10	SMB_DATA
ERROR_LED-	11	12	+5V
FRONT_LAN1_ACT	13	14	FRONT_LAN1_LINK100#
GND	15	16	FRONT_LAN1_LINK1000#
FRONT_LAN2_ACT	17	18	FRONT_LAN2_LINK100#
GND	19	20	FRONT_LAN2_LINK1000#

2.3.24 Serial port 2 connector (COM2)

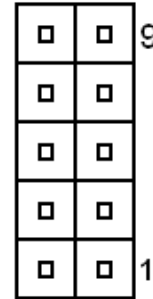
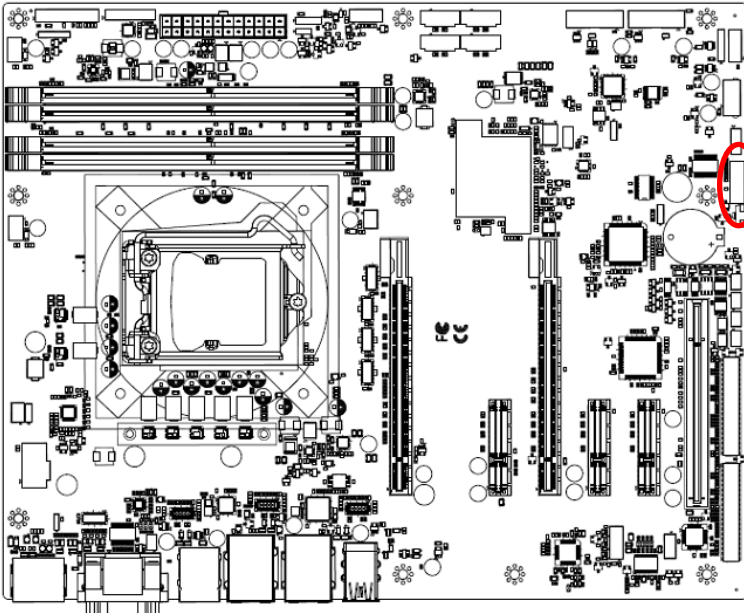

Signal	PIN	PIN	Signal
NC	10	9	NRIB#
NCTSB#	8	7	NRTSB#
NDSRB#	6	5	GND
NDTRB#	4	3	NTXDB
NRXDB	2	1	NDCDB#

2.3.25 USB connector (JUSB1)

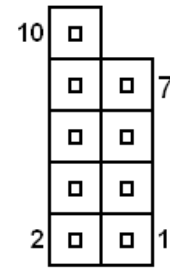
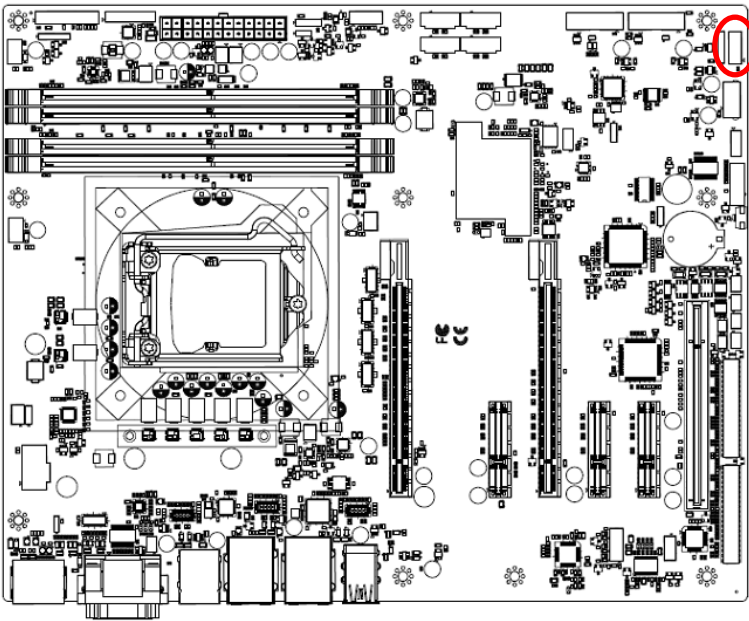

Signal	PIN	PIN	Signal
NC	10		
GND	8	7	GND
USB_10P	6	5	USB_9P
USB_10N	4	3	USB_9N
+5V	2	1	+5V

2.3.26 USB connector (JUSB3)

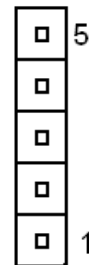
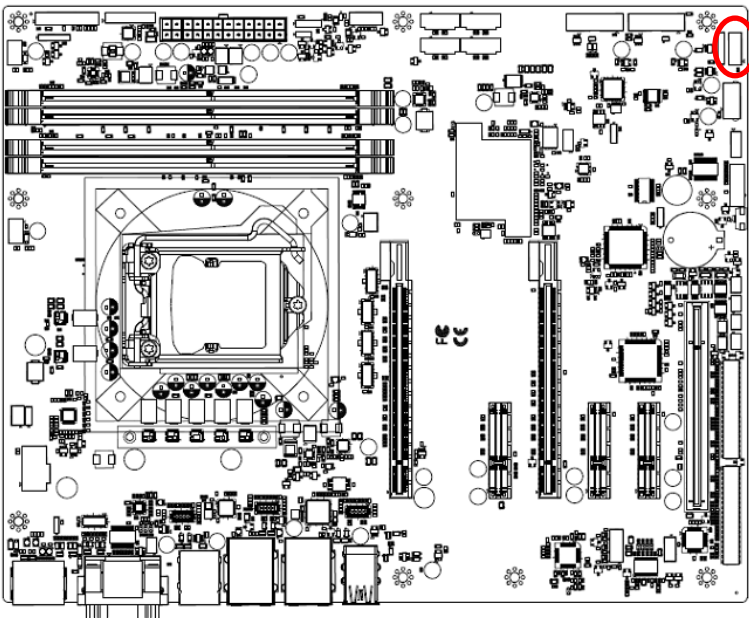

Signal	PIN
NC	5
GND	4
USB_P14	3
USB_N14	2
+V5A_USB14	1

2.3.27 J1RS2 connector (J1RS2)

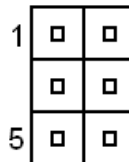
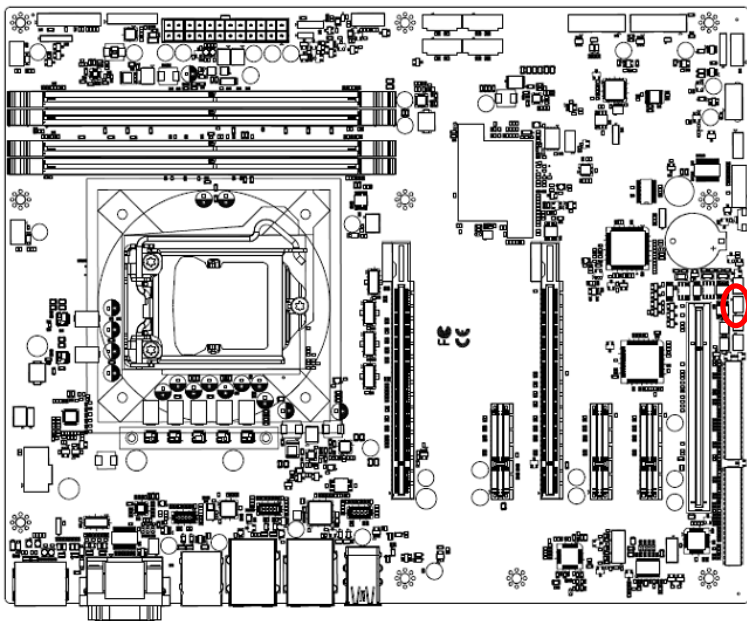

Signal	PIN	PIN	Signal
A485TX-	1	2	A422RX-
A485TX+	3	4	A422RX+
+5V	5	6	GND



Note: J1RS2 for COM2 RS422/485

2.3.28 J1RS3 connector (J1RS3)

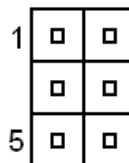
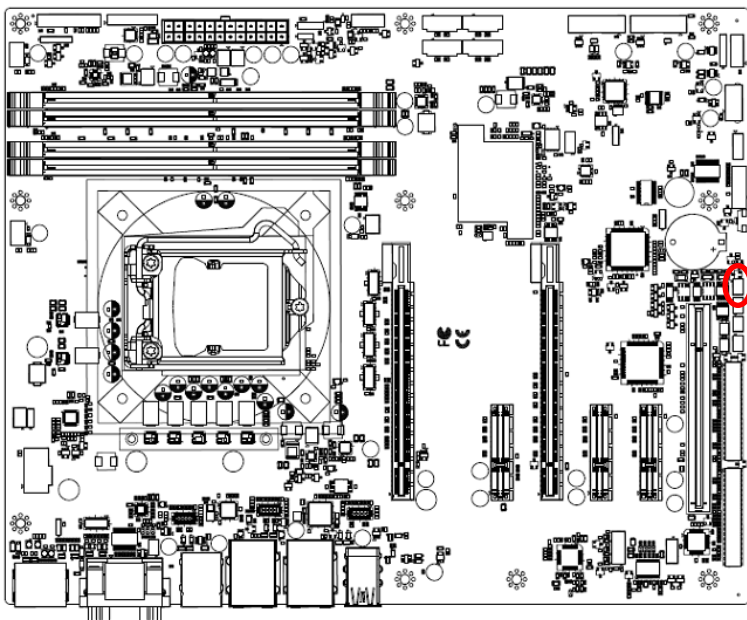

Signal	PIN	PIN	Signal
B485TX-	1	2	B422RX-
B485TX+	3	4	B422RX+
+5V	5	6	GND



Note: J1RS3 for COM3 RS422/485

2.3.29 Audio connector (FAUD1)

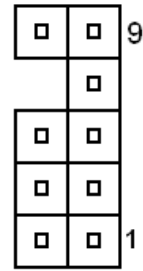
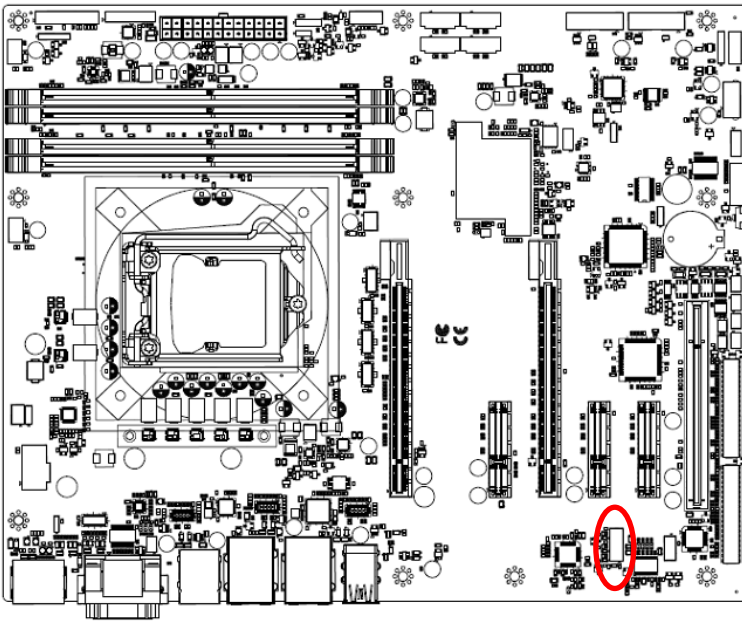

Signal	PIN	PIN	Signal
LINE2_JD	10	9	LINE2_LIN
		7	SENSE_B
MIC2_JD	6	5	LINE2_RIN
ACZ_DET#	4	3	MIC2_RIN
GND	2	1	MIC2_LIN

2.3.30 Auxiliary Fan connector (AUXFAN1)

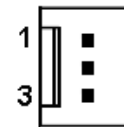
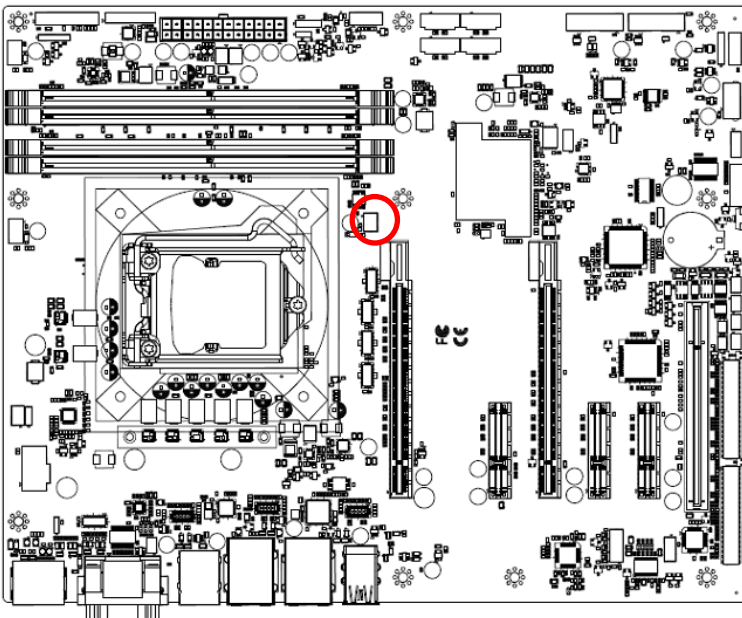

Signal	PIN
GND	1
+12V	2
AUX_R_FANIN	3

2.3.31 Serial port connector (4COM1)

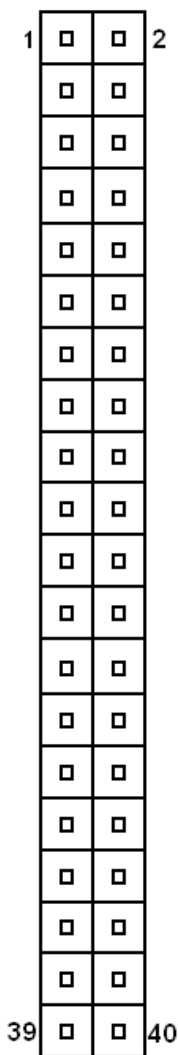
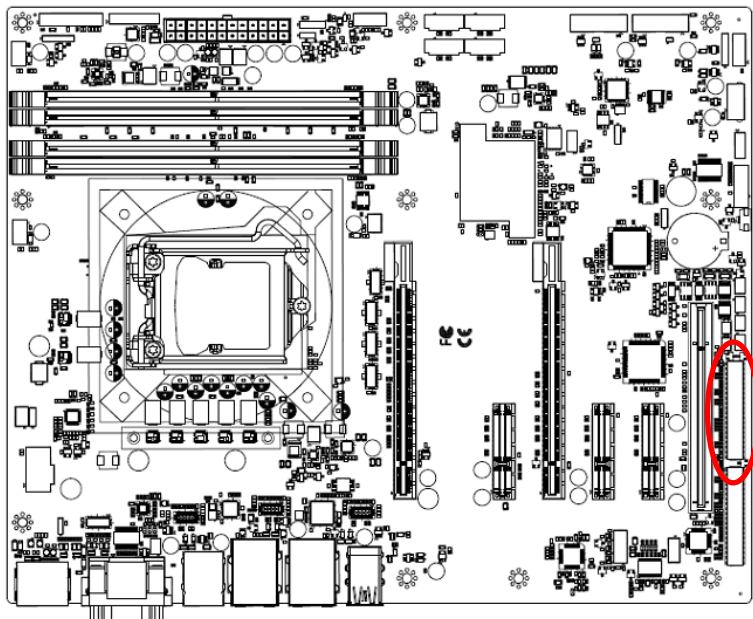

Signal	PIN	PIN	Signal
NDCDC#	1	2	NRXDC
NTXDC	3	4	NDTRC#
GND	5	6	NDSRC#
NRTSC#	7	8	NCTSC#
NRIC#	9	10	NC
NDCDD#	11	12	NRXDD
NTXDD	13	14	NDTRD#
GND	15	16	NDSRD#
NRTSD#	17	18	NCTSD#
NRID#	19	20	NC
NDCDE#	21	22	NRXDE
NTXDE	23	24	NDTRE#
GND	25	26	NDSRE#
NRTSE#	27	28	NCTSE#
NRIE#	29	30	NC
NDCDF#	31	32	NRXDF
NTXDF	33	34	NDTRF#
GND	35	36	NDSRF#
NRTSF#	37	38	NCTSF#
NRIF#	39	40	NC

2.3.32 Serial port connector (4COM2)

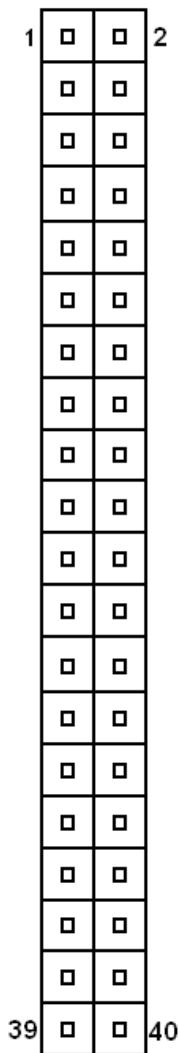
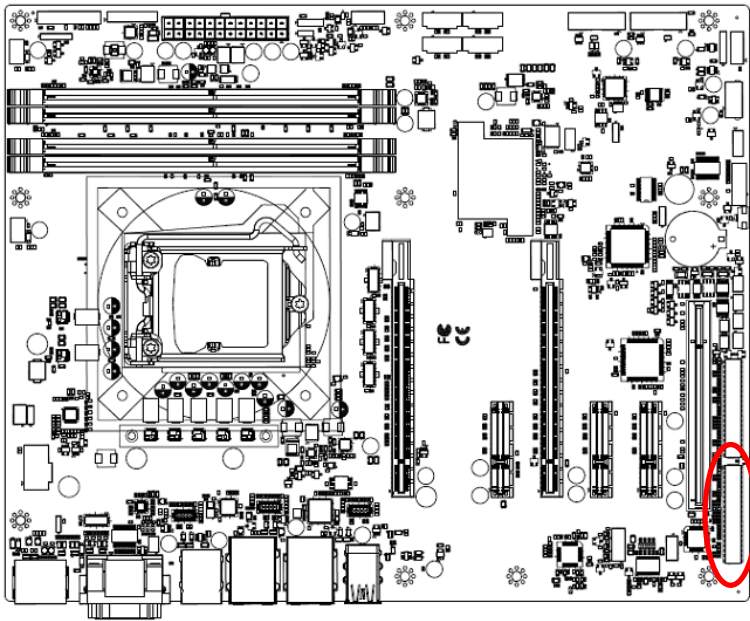

Signal	PIN	PIN	Signal
NDCD1#	1	2	NRXD1
NTXD1	3	4	NDTR1#
GND	5	6	NDSR1#
NRTS1#	7	8	NCTS1#
NRI1#	9	10	NC
NDCD2#	11	12	NRXD2
NTXD2	13	14	NDTR2#
GND	15	16	NDSR2#
NRTS2#	17	18	NCTS2#
NRI2#	19	20	NC
NDCD3#	21	22	NRXD3
NTXD3	23	24	NDTR3#
GND	25	26	NDSR3#
NRTS3#	27	28	NCTS3#
NRI3#	29	30	NC
NDCD4#	31	32	NRXD4
NTXD4	33	34	NDTR4#
GND	35	36	NDSR4#
NRTS4#	37	38	NCTS4#
NRI4#	39	40	NC

2.3.33 JPC1 connector (JPC1)

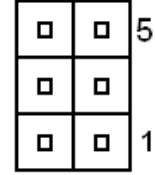
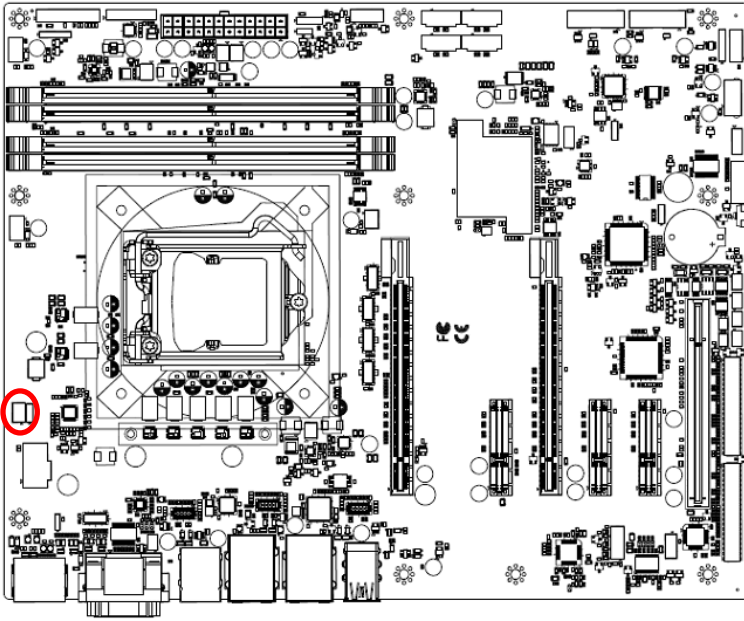

Signal	PIN	PIN	Signal
+V3.3_EXT	6	5	NC
VCCCORE_PMSCL	4	3	GND
VCCCORE_PMSDA	2	1	VCCCORE_nPMALERT

3. BIOS Setup

3.1 Introduction

The BIOS setup program allows users to modify the basic system configuration. In this following chapter will describe how to access the BIOS setup program and the configuration options that may be changed.

3.2 Starting Setup

The AMI BIOS™ is immediately activated when you first power on the computer. The BIOS reads the system information contained in the NVRAM and begins the process of checking out the system and configuring it. When it finishes, the BIOS will seek an operating system on one of the disks and then launch and turn control over to the operating system.

While the BIOS is in control, the Setup program can be activated in one of two ways:

By pressing or <F2> immediately after switching the system on, or

By pressing the or <F2> key when the following message appears briefly at the left-top of the screen during the POST (Power On Self Test).

Press or <F2> to enter SETUP

If the message disappears before you respond and you still wish to enter Setup, restart the system to try again by turning it OFF then ON or pressing the "RESET" button on the system case. You may also restart by simultaneously pressing <Ctrl>, <Alt>, and <Delete> keys. If you do not press the keys at the correct time and the system does not boot, an error message will be displayed and you will again be asked to.

Press F1 to Continue, DEL to enter SETUP

3.3 Using Setup

In general, you use the arrow keys to highlight items, press <Enter> to select, use the PageUp and PageDown keys to change entries, press <F1> for help and press <Esc> to quit. The following table provides more detail about how to navigate in the Setup program using the keyboard.

Button	Description
↑	Move to previous item
↓	Move to next item
←	Move to the item in the left hand
→	Move to the item in the right hand
Esc key	Main Menu -- Quit and not save changes into NVRAM Status Page Setup Menu and Option Page Setup Menu -- Exit current page and return to Main Menu
+ key	Increase the numeric value or make changes
- key	Decrease the numeric value or make changes
F1 key	General help, only for Status Page Setup Menu and Option Page Setup Menu
F2 key	Previous Values.
F3 key	Optimized defaults
F4 key	Save & Exit Setup

- **Navigating Through The Menu Bar**

Use the left and right arrow keys to choose the menu you want to be in.



Note: Some of the navigation keys differ from one screen to another.

- **To Display a Sub Menu**

Use the arrow keys to move the cursor to the sub menu you want. Then press <Enter>. A “>” pointer marks all sub menus.

3.4 Getting Help

Press F1 to pop up a small help window that describes the appropriate keys to use and the possible selections for the highlighted item. To exit the Help Window press <Esc> or the F1 key again.

3.5 In Case of Problems

If, after making and saving system changes with Setup, you discover that your computer no longer is able to boot, the AMI BIOS supports an override to the NVRAM settings which resets your system to its defaults.

The best advice is to only alter settings which you thoroughly understand. To this end, we strongly recommend that you avoid making any changes to the chipset defaults. These defaults have been carefully chosen by both BIOS Vendor and your systems manufacturer to provide the absolute maximum performance and reliability. Even a seemingly small change to the chipset setup has the potential for causing you to use the override.

3.6 BIOS setup

Once you enter the Aptio Setup Utility, the Main Menu will appear on the screen. The Main Menu allows you to select from several setup functions and exit choices. Use the arrow keys to select among the items and press <Enter> to accept and enter the sub-menu.

3.6.1 Main Menu

This section allows you to record some basic hardware configurations in your computer and set the system clock.

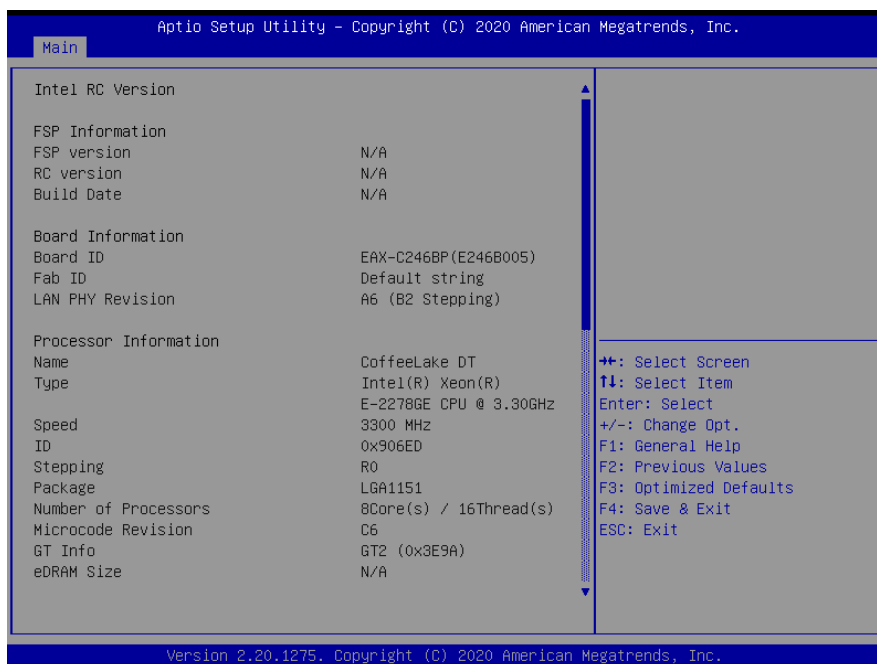
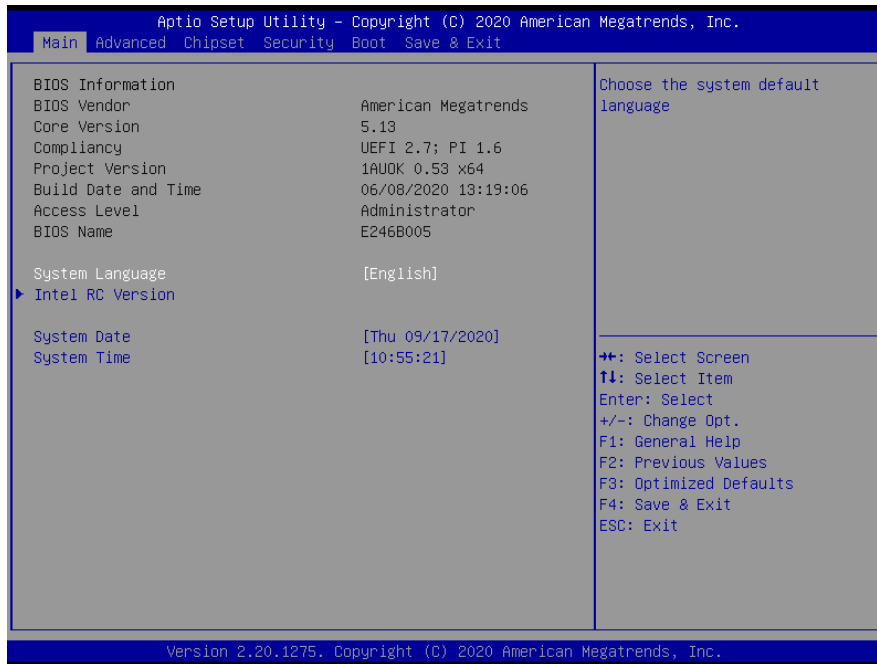

EAX-C246BP User's Manual

3.6.1.1 System Language

This option allows choosing the system default language.

3.6.1.2 System Date

Use the system date option to set the system date. Manually enter the day, month and year.

3.6.1.3 System Time

Use the system time option to set the system time. Manually enter the hours, minutes and seconds.



Note: The BIOS setup screens shown in this chapter are for reference purposes only, and may not exactly match what you see on your screen. Visit the Avalue website (www.avalue.com.tw) to download the latest product and BIOS information.

3.6.2 Advanced Menu

This section allows you to configure your CPU and other system devices for basic operation through the following sub-menus.

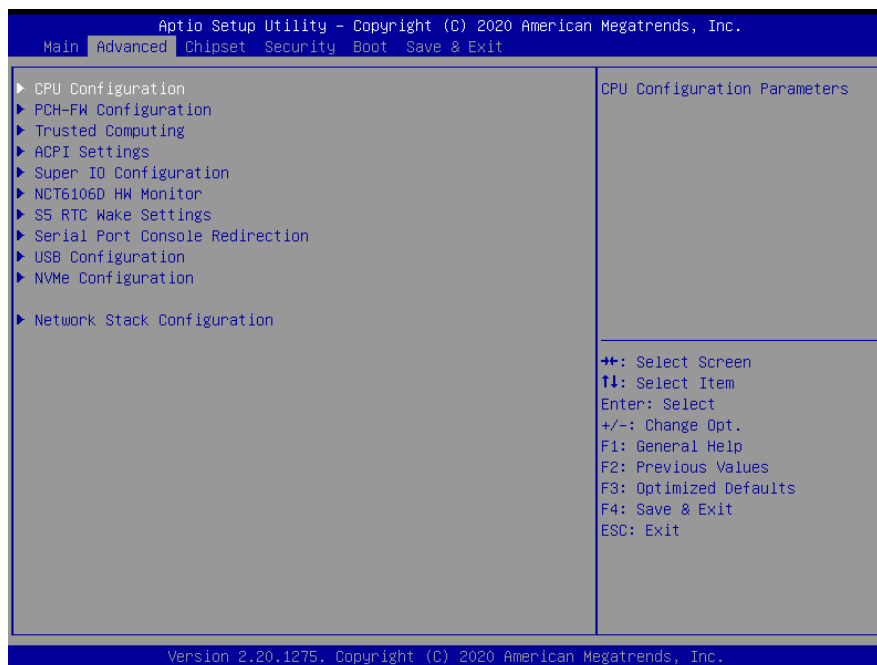

3.6.2.1 CPU Configuration



Item	Options	Description
Intel (VMX) Virtualization Technology	Disabled Enabled[Default],	When enabled, a VMM can utilize the additional hardware capabilities provided by Vanderpool Technology.
Active Processor Cores	All[Default], 1 2 3 4 5 6 7 8	Number of cores to enable in each processor package.

EAX-C246BP User's Manual

3.6.2.1.1 CPU - Power Management Control

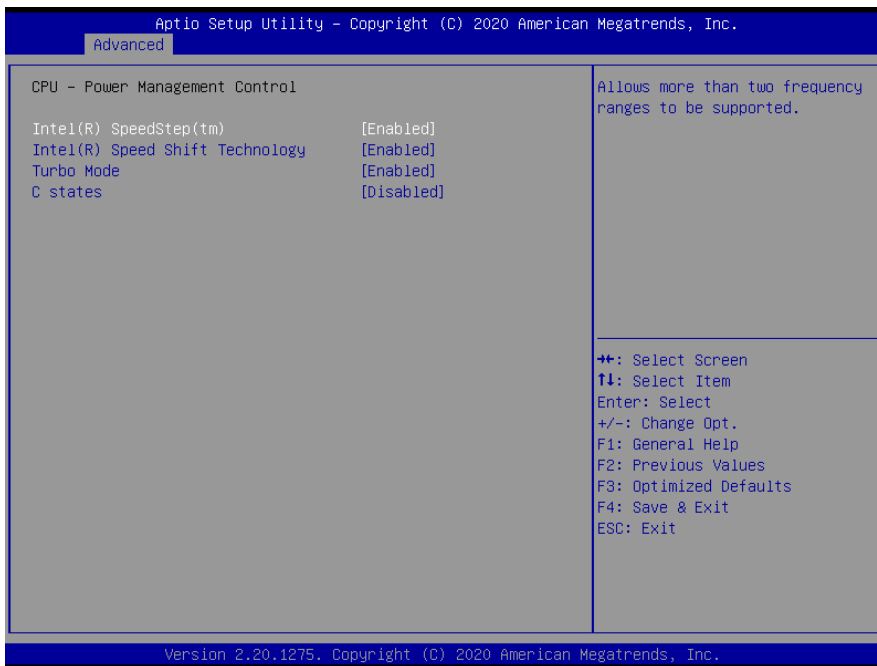

Item	Options	Description
Intel(R) SpeedStep(tm)	Disabled Enabled[Default],	Allows more than two frequency ranges to be supported.
Intel(R) Speed Shift Technology	Disabled Enabled[Default],	Enable/Disable Intel(R) Speed Shift Technology support. Enabling will expose the CPPC v2 interface to allow for hardware controlled P-states.
Turbo Mode	Disabled Enabled[Default],	Enable/Disable processor Turbo Mode (requires Intel Speed Step or Intel Speed Shift to be available and enabled).
C states	Disabled[Default], Enabled	Enable/Disable CPU Power Management. Allows CPU to go to C states when it's not 100% utilized.

3.6.2.2 PCH-FW Configuration

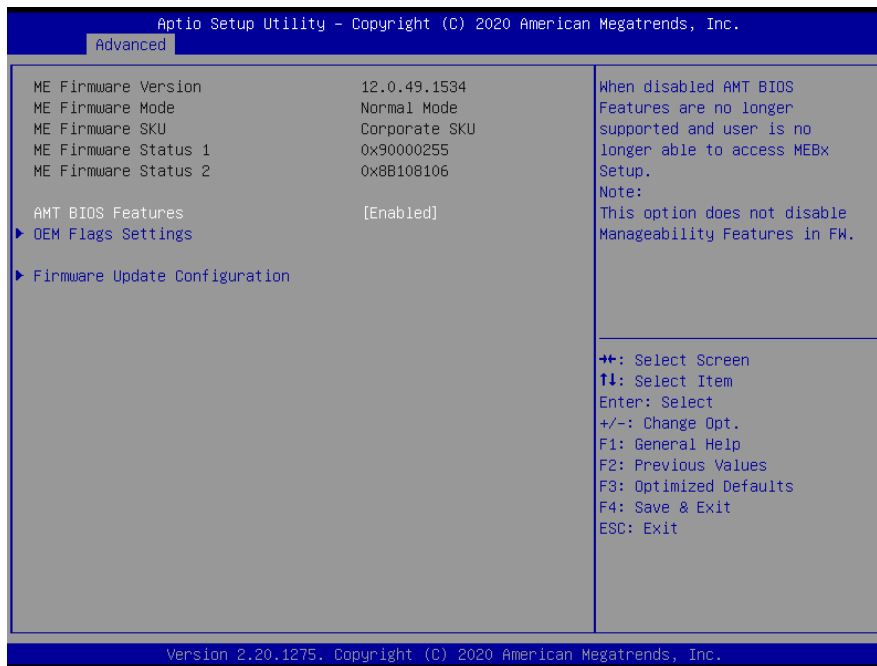

Item	Options	Description
AMT BIOS Features	Disabled Enabled[Default],	When disabled AMT BIOS Feature are no longer supported and user is no longer able to access MEBx Setup. Note: This option does not disable Manageability Features in FW.

3.6.2.2.1 OEM Flags Settings



EAX-C246BP User's Manual

Item	Option	Description
Unconfigure ME	Default[Default], Extended User USER Supervisor	OEMFlag Bit 15: Unconfigure ME with resetting MEBx password to default.

3.6.2.2.2 Firmware Update Configuration



Item	Option	Description
Me FW Image Re-Flash	Disabled[Default], Enabled	Enable/Disable Me FW Image Re-Flash function.

3.6.2.3 Trusted Computing

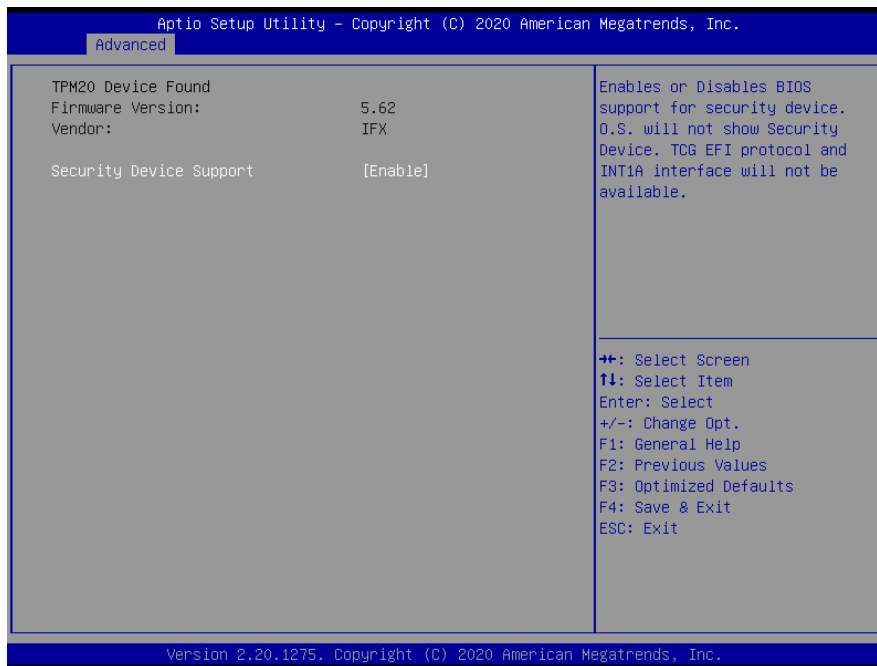

Item	Options	Description
Security Device Support	Disable, Enable[Default]	Enables or Disables BIOS support for security device. O.S. will not show Security Device. TCG EFI protocol and INT1A interface will not be available.

3.6.2.4 ACPI Settings

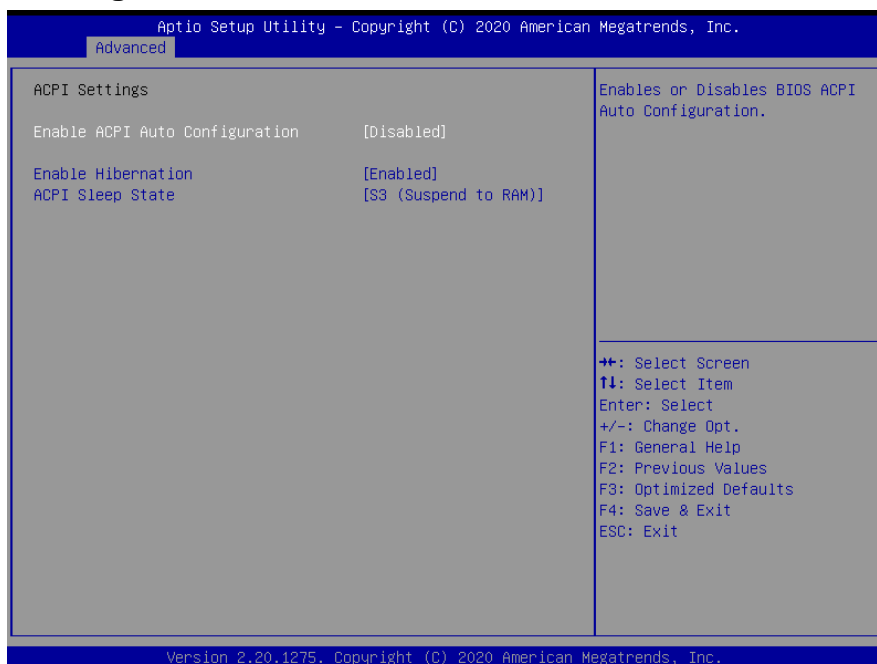

Item	Options	Description
Enable ACPI Auto	Disabled[Default],	Enables or Disables BIOS ACPI Auto

EAX-C246BP User's Manual

Configuration	Enabled	Configuration.
Enable Hibernation	Disabled Enabled[Default],	Enables or Disables System ability to Hibernate (OS/S4 Sleep State). This option may not be effective with some operating systems.
ACPI Sleep State	Suspend Disabled, S3 (Suspend to RAM)[Default]	Select the highest ACPI sleep state the system will enter when the SUSPEDN button is pressed.

3.6.2.5 Super IO Configuration

You can use this item to set up or change the Super IO configuration for serial ports. Please refer to 3.6.2.5.1~ 3.6.2.5.10 for more information.

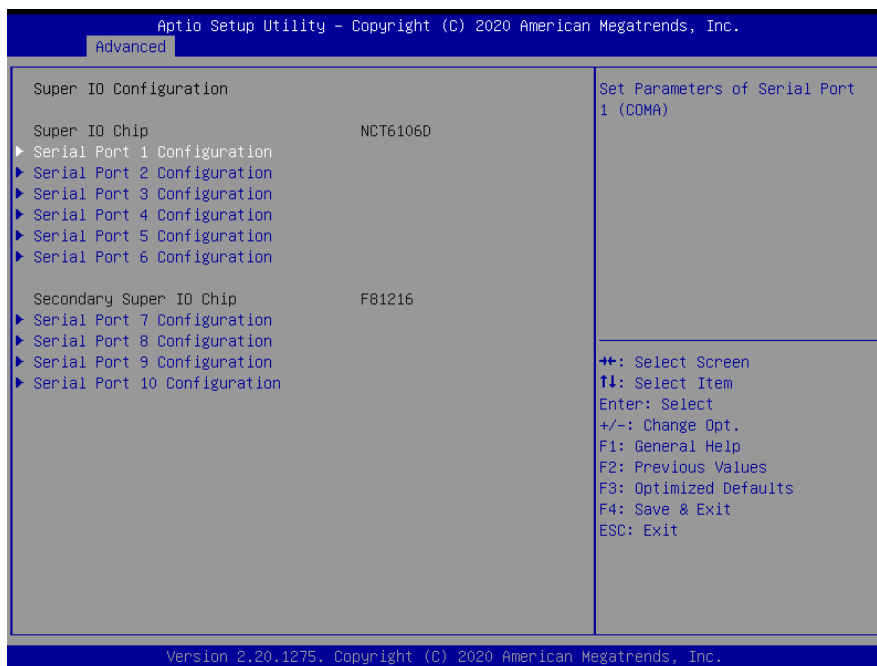

Item	Description
Serial Port 1 Configuration	Set Parameters of Serial Port 1 (COMA).
Serial Port 2 Configuration	Set Parameters of Serial Port 2 (COMB).
Serial Port 3 Configuration	Set Parameters of Serial Port 3 (COMC).
Serial Port 4 Configuration	Set Parameters of Serial Port 4 (COMD).
Serial Port 5 Configuration	Set Parameters of Serial Port 5 (COME).
Serial Port 6 Configuration	Set Parameters of Serial Port 6 (COMF).
Serial Port 7 Configuration	Set Parameters of Serial Port 7 (COMG).
Serial Port 8 Configuration	Set Parameters of Serial Port 8 (COMH).
Serial Port 9 Configuration	Set Parameters of Serial Port 9 (COMI).
Serial Port 10 Configuration	Set Parameters of Serial Port 10 (COMJ).

3.6.2.5.1 Serial Port 1 Configuration

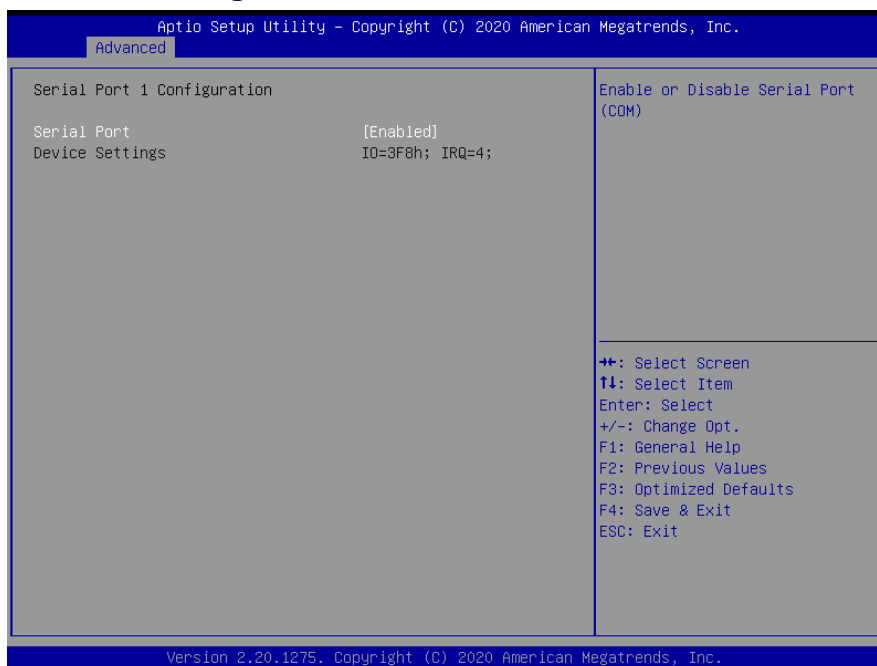

Item	Option	Description
Serial Port	Disabled Enabled[Default],	Enable or Disable Serial Port (COM).

3.6.2.5.2 Serial Port 2 Configuration

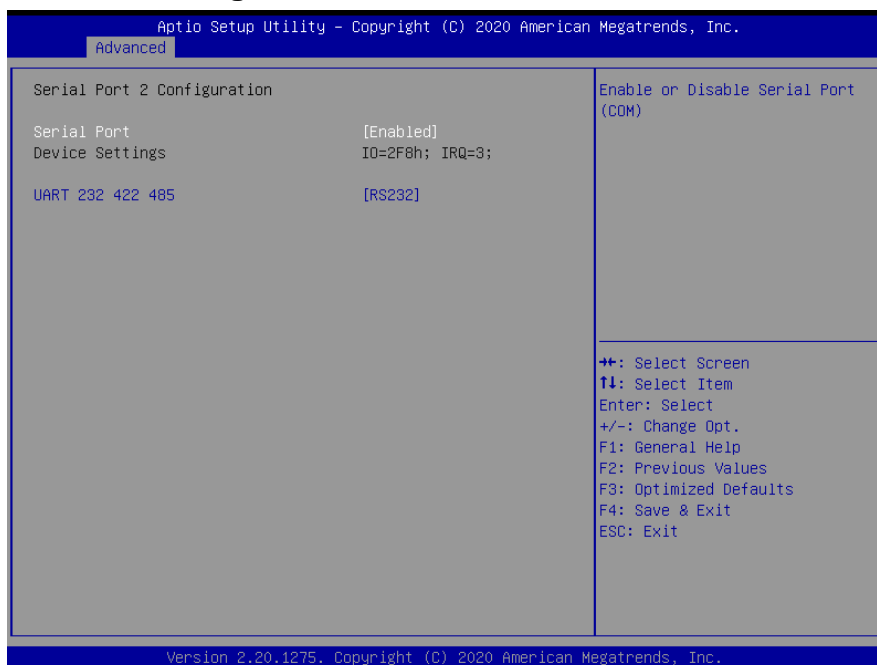

Item	Option	Description
Serial Port	Disabled Enabled[Default],	Enable or Disable Serial Port (COM).
UART 232 422 485	RS232[Default] RS422	Set COM Port as RS232, RS422 or RS485 mode.

	RS485	
--	-------	--

3.6.2.5.3 Serial Port 3 Configuration

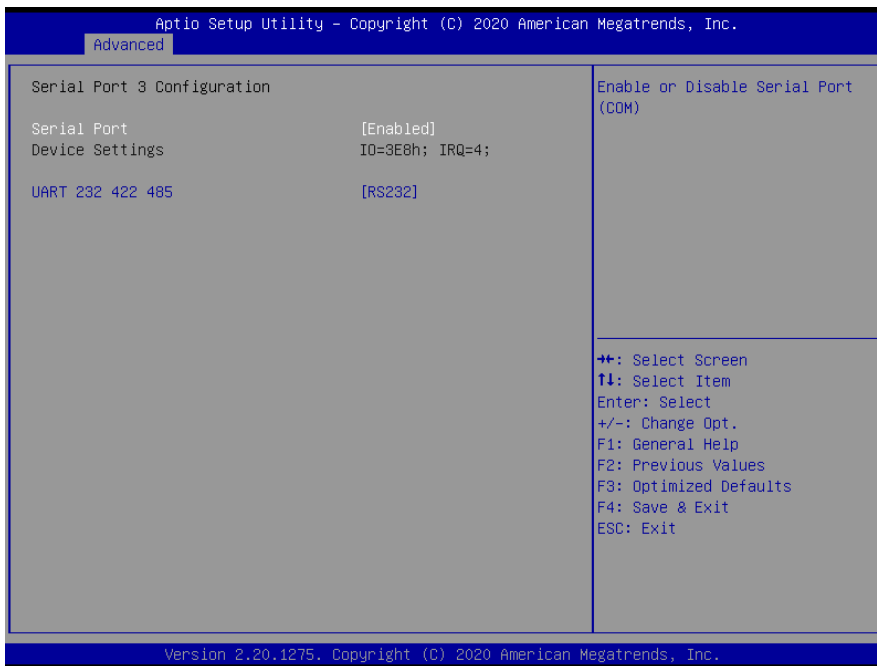

Item	Option	Description
Serial Port	Disabled Enabled[Default],	Enable or Disable Serial Port (COM).
UART 232 422 485	RS232[Default] RS422 RS485	Set COM Port as RS232, RS422 or RS485 mode.

3.6.2.5.4 Serial Port 4 Configuration

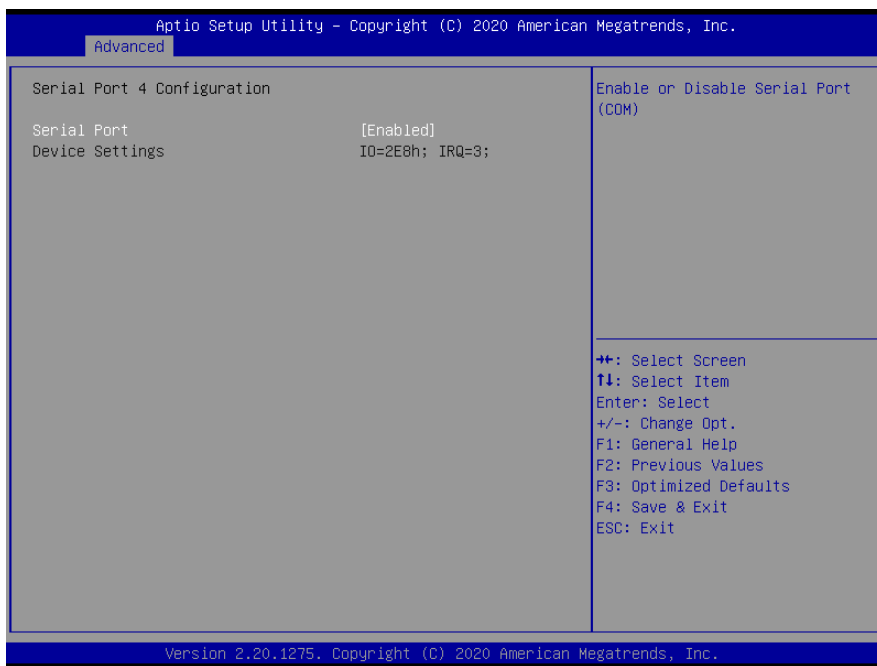

Item	Option	Description
Serial Port	Disabled Enabled[Default],	Enable or Disable Serial Port (COM).

3.6.2.5.5 Serial Port 5 Configuration

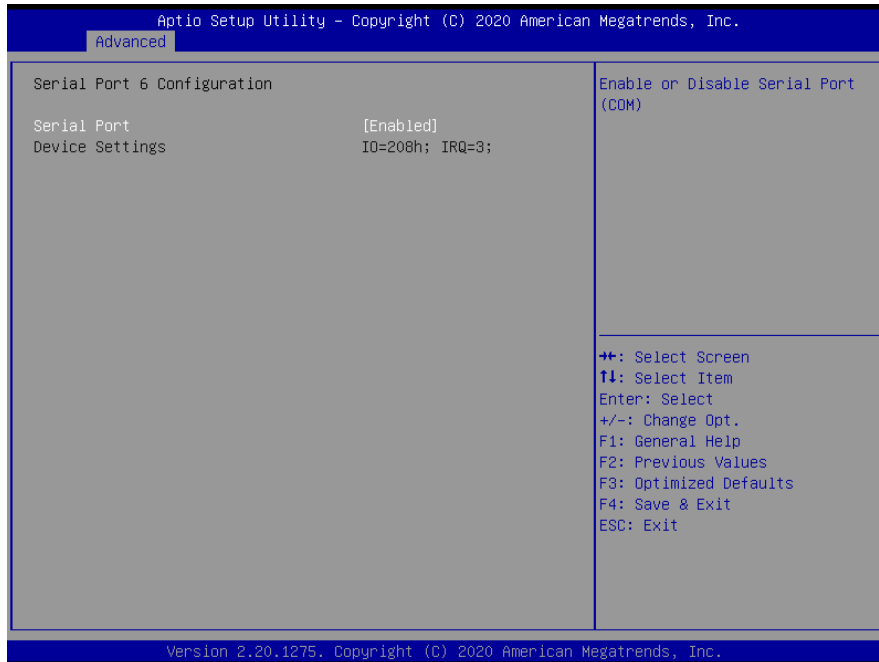

Item	Option	Description
Serial Port	Disabled Enabled[Default],	Enable or Disable Serial Port (COM).

3.6.2.5.6 Serial Port 6 Configuration

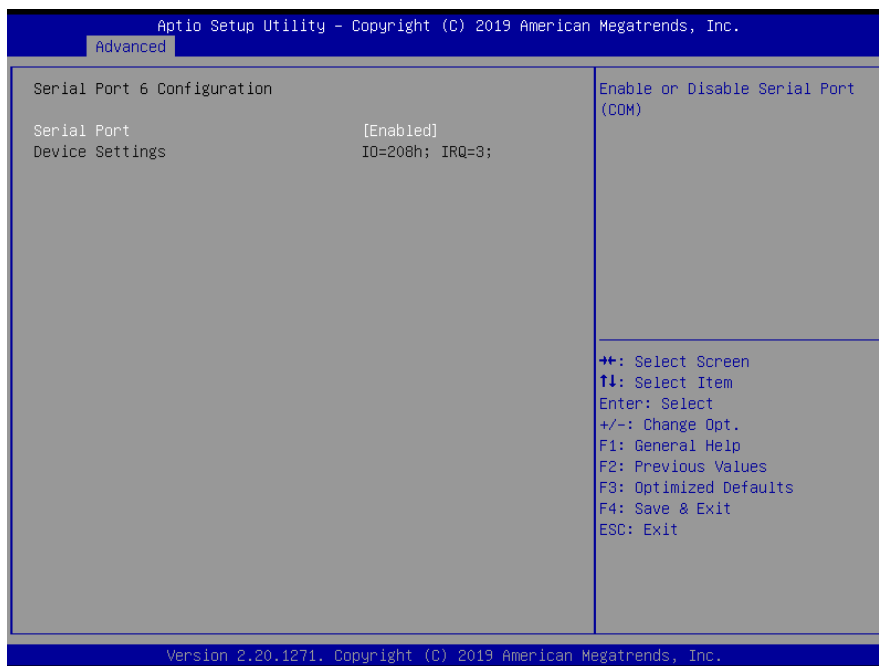

EAX-C246BP User's Manual

Item	Option	Description
Serial Port	Disabled Enabled[Default],	Enable or Disable Serial Port (COM).

3.6.2.5.7 Serial Port 7 Configuration

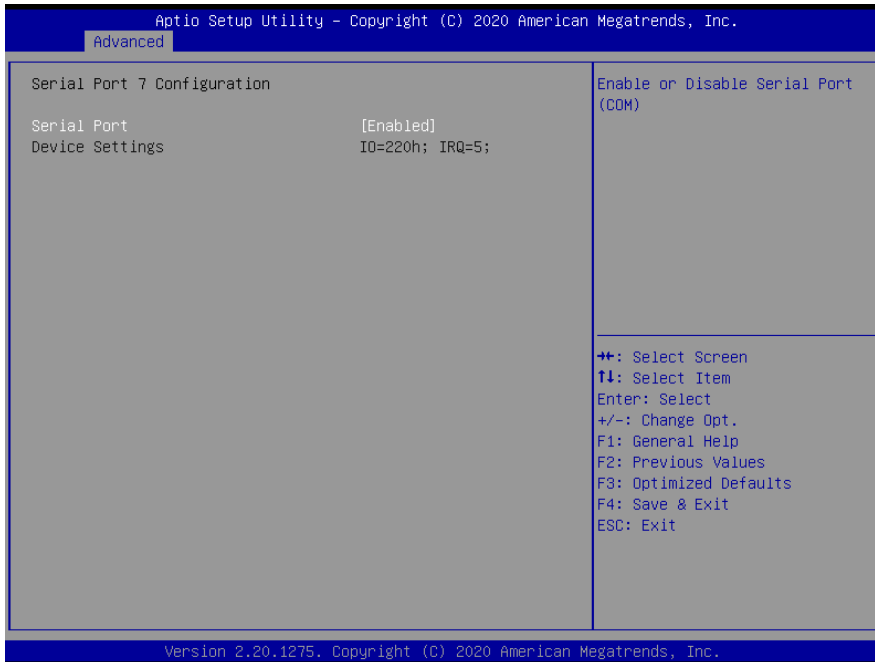

Item	Option	Description
Serial Port	Disabled Enabled[Default],	Enable or Disable Serial Port (COM).

3.6.2.5.8 Serial Port 8 Configuration



Item	Option	Description
Serial Port	Disabled Enabled[Default],	Enable or Disable Serial Port (COM).

3.6.2.5.9 Serial Port 9 Configuration

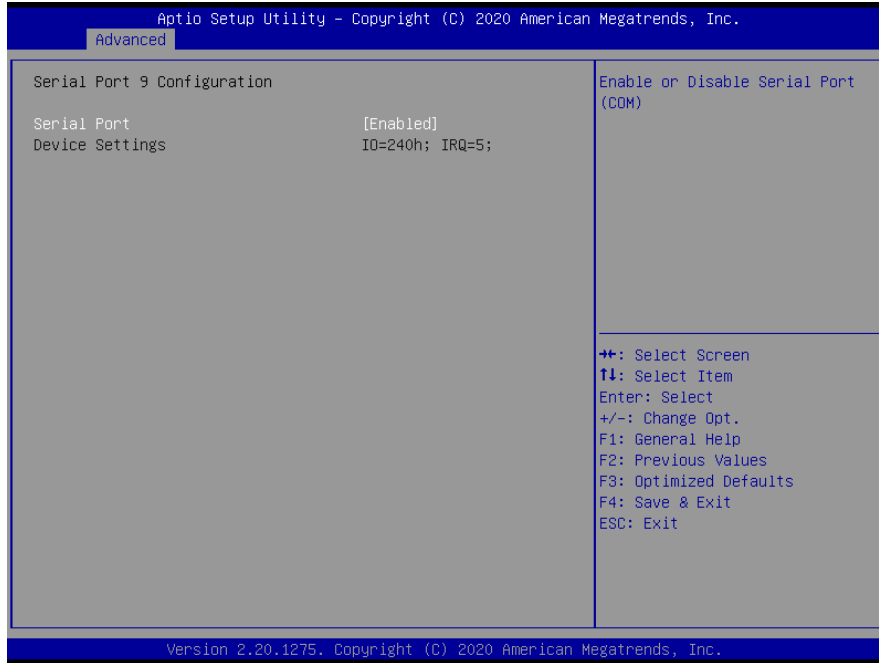

Item	Option	Description
Serial Port	Disabled Enabled[Default],	Enable or Disable Serial Port (COM).

3.6.2.5.10 Serial Port 10 Configuration

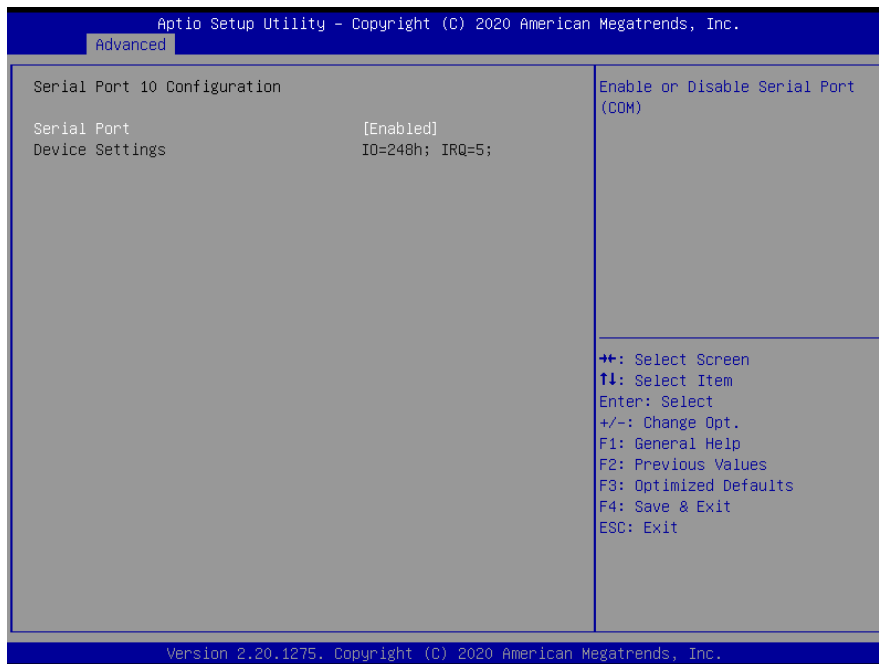

EAX-C246BP User's Manual

Item	Option	Description
Serial Port	Disabled Enabled[Default],	Enable or Disable Serial Port (COM).

3.6.2.6 NCT6106D H/W Monitor

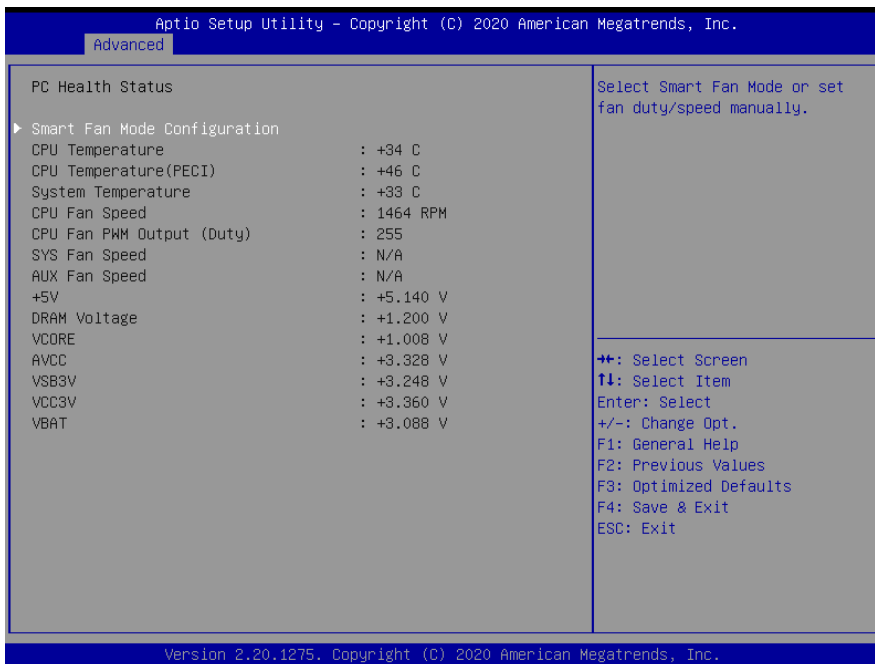

3.6.2.6.1 Smart Fan Configuration

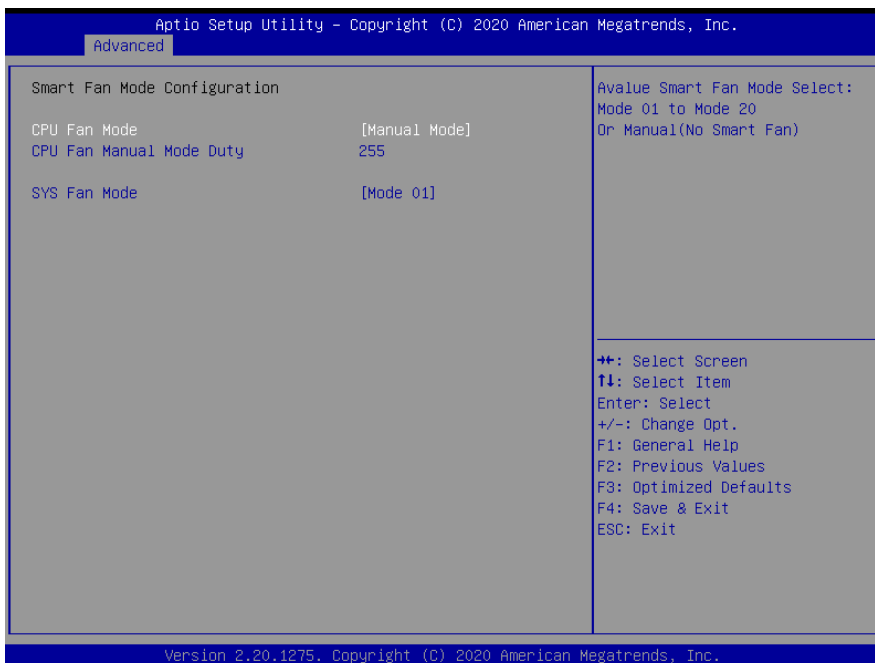

Item	Option	Description
CPU Fan Mode	Manual Mode[Default], Mode 01 Mode 02 Mode 03 Mode 04	Avalue Smart Fan Mode Select: Mode 01 to Mode 20 Or Manual (No Smart Fan)

	Mode 05 Mode 06 Mode 07 Mode 08 Mode 09 Mode 10 Mode 11 Mode 12 Mode 13 Mode 14 Mode 15 Mode 16 Mode 17 Mode 18 Mode 19 Mode 20	
CPU Fan Manual Mode Duty	255[Default]	Set Fan Duty Manually(1~255).
SYS FAN Mode	Manual Mode Mode 01[Default], Mode 02 Mode 03 Mode 04 Mode 05 Mode 06 Mode 07 Mode 08 Mode 09 Mode 10 Mode 11 Mode 12 Mode 13 Mode 14 Mode 15 Mode 16 Mode 17 Mode 18 Mode 19 Mode 20	Avalue Smart Fan Mode Select: Mode 01 to Mode 20 Or Manual (No Smart Fan)

3.6.2.7 S5 RTC Wake Settings



Item	Options	Description
Wake system from S5	Disabled[Default], Fixed Time Dynamic Time	Enable or disable System wake on alarm event. Select Fixed Time, system will wake on the hr::min::sec specified. Select Dynamic Time, System will wake on the current time + Increase minute(s).

3.6.2.8 Serial Port Console Redirection

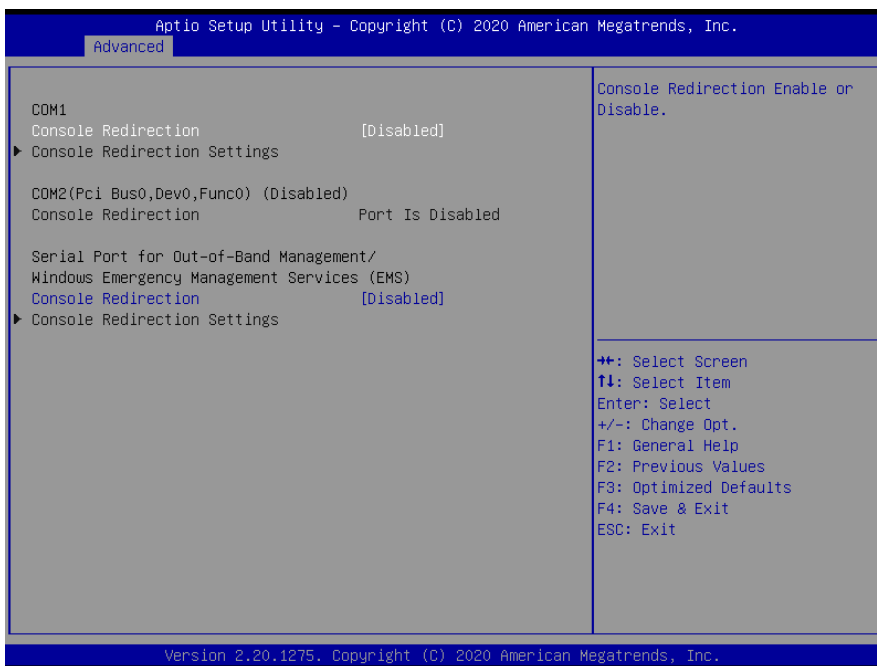

Item	Options	Description
Console Redirection	Disabled[Default], Enabled	Console Redirection Enable or Disable.

3.6.2.9 USB Configuration

The USB Configuration menu helps read USB information and configures USB settings.

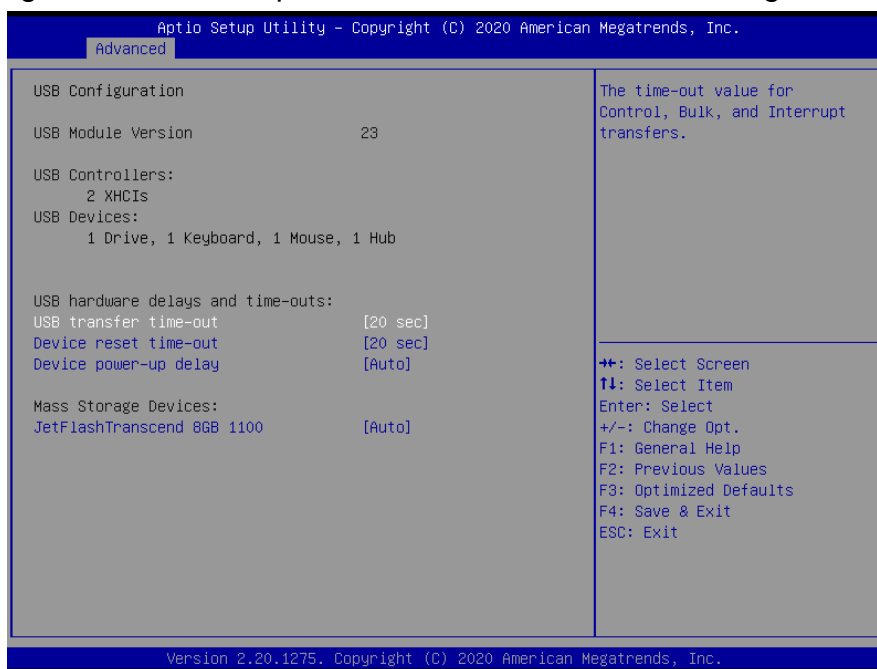

Item	Options	Description
USB transfer time-out	1 sec 5 sec 10 sec 20 sec [Default]	The time-out value for Control, Bulk, and Interrupt transfers.
Device reset time-out	10 sec 20 sec [Default] 30 sec 40 sec	USB mass storage device Start Unit command time-out.
Device power-up delay	Auto [Default] Manual	Maximum time the device will take before it properly reports itself to the Host Controller. 'Auto' uses default value: for a Root port it is 100ms, for a Hub port the delay is taken from Hub descriptor.
Mass Storage Devices	Auto [Default] Floppy Forced FDD Hard Disk CD-ROM	Mass storage device emulation type. 'AUTO' enumerates devices according to their media format. Optical drives are emulated as 'CDROM', drives with no media will be emulated according to a drive type.

EAX-C246BP User's Manual

3.6.2.10 NVMe Configuration

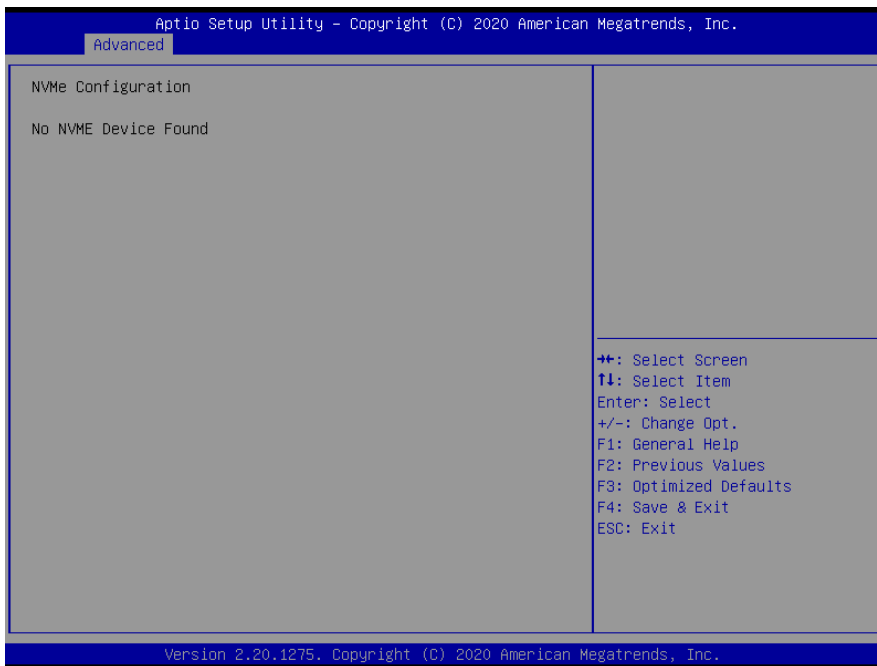

3.6.2.11 Network Stack Configuration

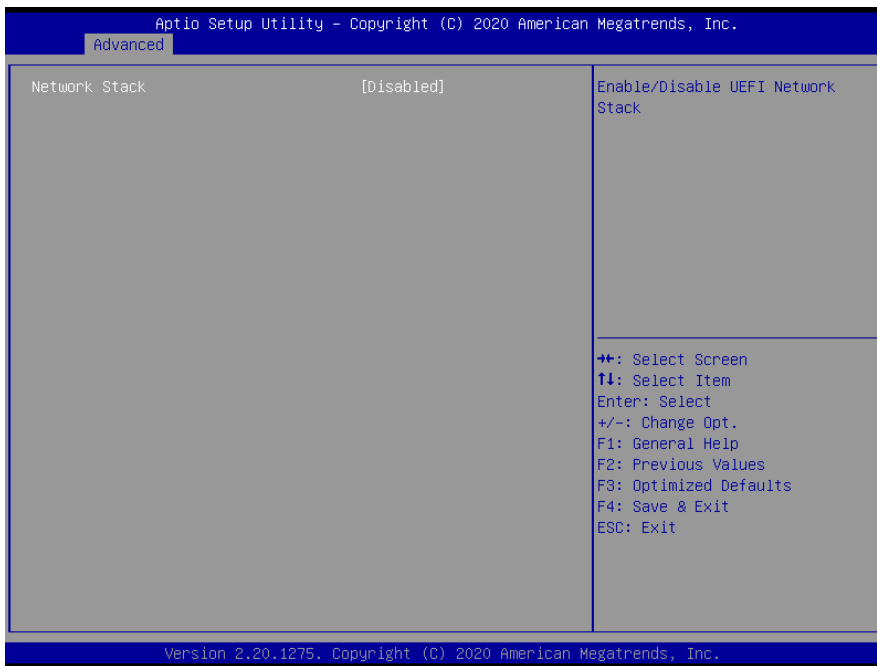

Item	Options	Description
Network Stack	Disabled[Default], Enabled	Enable/Disable UEFI Network Stack.

3.6.3 Chipset



3.6.3.1 System Agent (SA) Configuration



Item	Option	Description
VT-d	Disabled Enabled[Default]	VT-d capability.

3.6.3.1.1 Memory Configuration

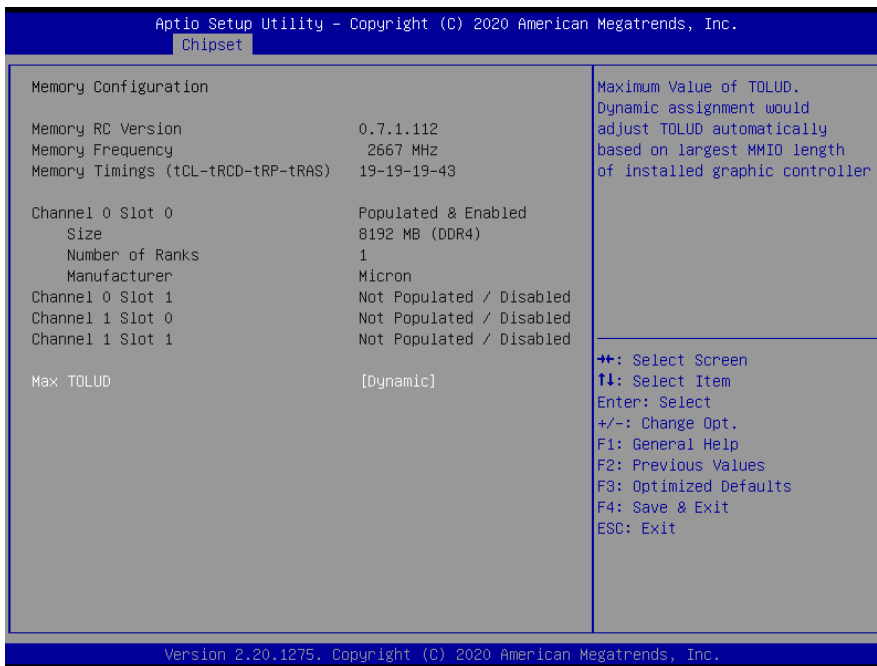

Item	Option	Description
<p style="text-align: center;">Max TOLUD</p>	<p style="text-align: center;">Dynamic[Default]</p>	<p style="text-align: center;">Maximum Value of TOLUD. Dynamic assignment would adjust TOLUD automatically based on largest MMIO length of installed graphic controller</p>
	1GB	
	1.25 GB	
	1.5 GB	
	1.75 GB	
	2 GB	
	2.25 GB	
	2.5 GB	
	2.75 GB	

3.6.3.1.2 Graphics Configuration

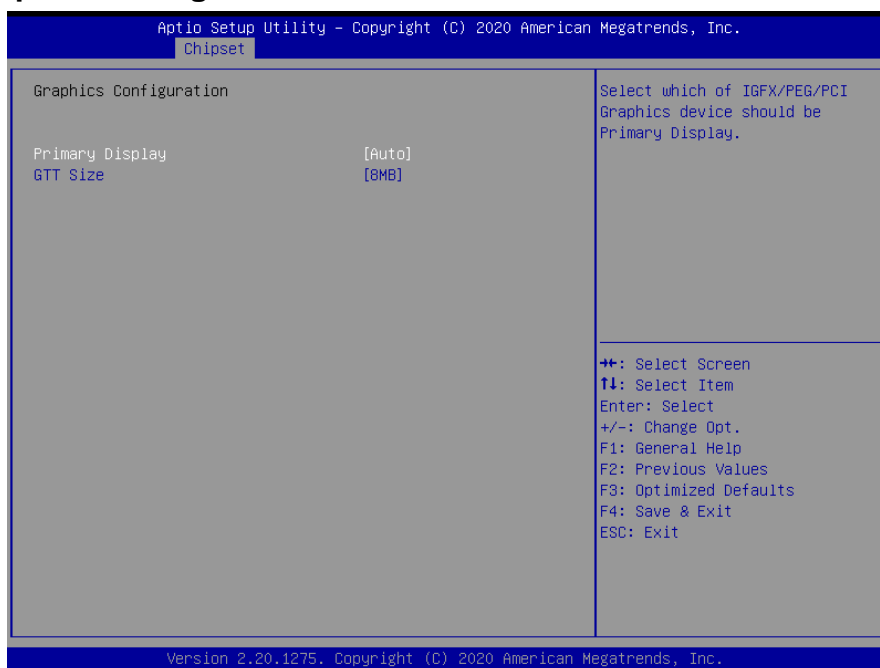

Item	Option	Description
Primary Display	Auto[Default]	Select which of IGFX/PEG/PCI Graphics device should be Primary Display
	IGFX	
	PEG	
	PCI	
GTT Size	2MB	Select the GTT Size
	4MB	
	8MB[Default]	

3.6.3.1.3 DMI/OPI Configuration



3.6.3.1.4 PEG Port Configuration

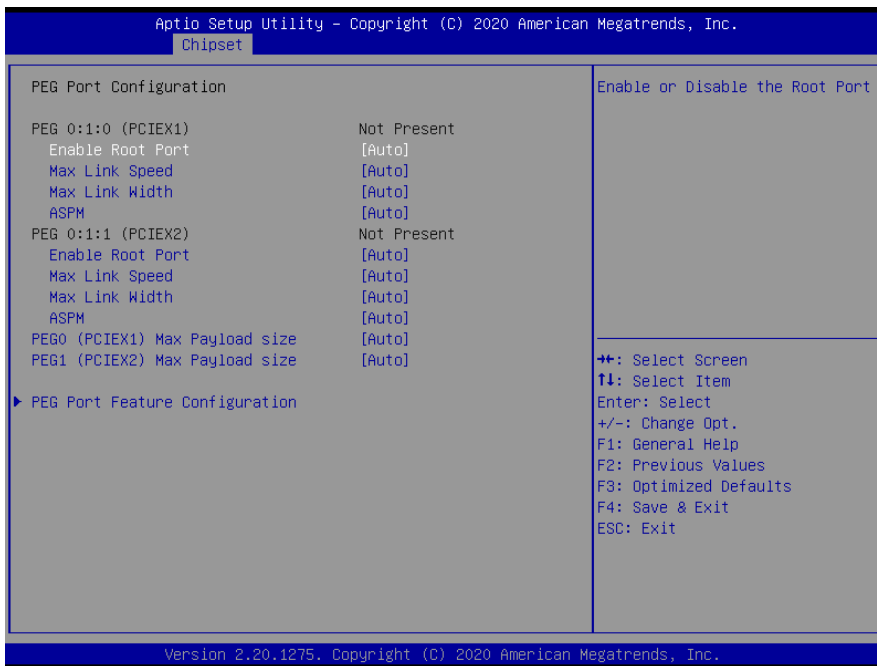

Item	Option	Description
Enable Root Port	Disabled Enabled Auto[Default]	Enable or Disable the Root Port.
Max Link Speed	Auto[Default] Gen1 Gen2 Gen3	Configure PEG 0:1:0 Max Speed
Max Link Width	Auto[Default] Force X1 Force X2 Force X4 Force X8	Force PEG link to retrain to X1/2/4/8
ASPM	Disabled Auto[Default] ASPM L0s ASPM L1 ASPM L0sL1	Control ASPM support for the PEG 0. This has no effect if PEG is not the currently active device.
Enable Root Port	Disabled Enabled Auto[Default]	Enable or Disable the Root Port.
Max Link Speed	Auto[Default] Gen1 Gen2 Gen3	Configure PEG 0:1:1 Max Speed
Max Link Width	Auto[Default] Force X1 Force X2 Force X4	Force PEG link to retrain to X1/2/4/8

ASPM	Disabled Auto[Default] ASPM L0s ASPM L1 ASPM L0sL1	Control ASPM support for the PEG1. This has no effect if PEG is not the currently active device.
PEG0 (PCIEX1) Max Payload size	Auto[Default] 128 256 TLP	Select PEG0 Max Payload size; Choose Auto(Default Device Capability) or force to 128/256 Bytes
PEG1 (PCIEX2) Max Payload size	Auto[Default] 128 256 TLP	Select PEG1 Max Payload size; Choose Auto(Default Device Capability) or force to 128/256 Bytes

3.6.3.1.4.1 PEG Port Feature Configuration



Item	Option	Description
Detect Non-Compliance Device	Disabled[Default] Enabled	Detect Non-Compliance PCI Express Device in PEG

3.6.3.2 PCH-IO Configuration



Item	Option	Description
PCH LAN Controller	Enabled[Default] Disabled	Enable/Disable onboard NIC.

3.6.3.2.1 PCI Express Configuration

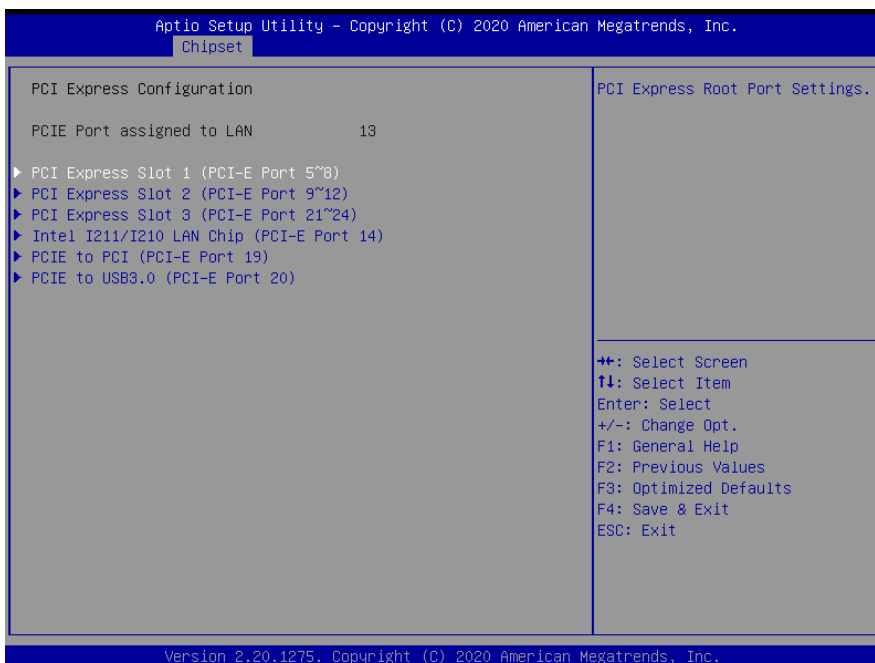

3.6.3.2.1.1 PCI Express Slot 1 (PCI-E Port 5~8)



Item	Option	Description
PCI Express Slot 1 (PCI-E Port 5~8)	Disabled Enabled[Default],	Control the PCI Express Root Port.
ASPM 4	Disabled[Default] L0s L1 L0sL1 Auto	Set the ASPM Level: Force L0s – Force all links to L0s State AUTO – BIOS auto configure DISABLE – Disables ASPM.
L1 Substates	Disabled L1.1 L1.1 & L1.2[Default]	PCI Express L1 Substates settings.
PCIe Speed	Auto[Default] Gen1 Gen2 Gen3	Configure PCIe Speed
Detect Timeout	0[Default],	The number of milliseconds reference code will wait for link to exit Detect state for enabled ports before assuming there is no device and potentially disabling the port.

3.6.3.2.1.2 PCI Express Slot 2 (PCI-E Port 9~12)

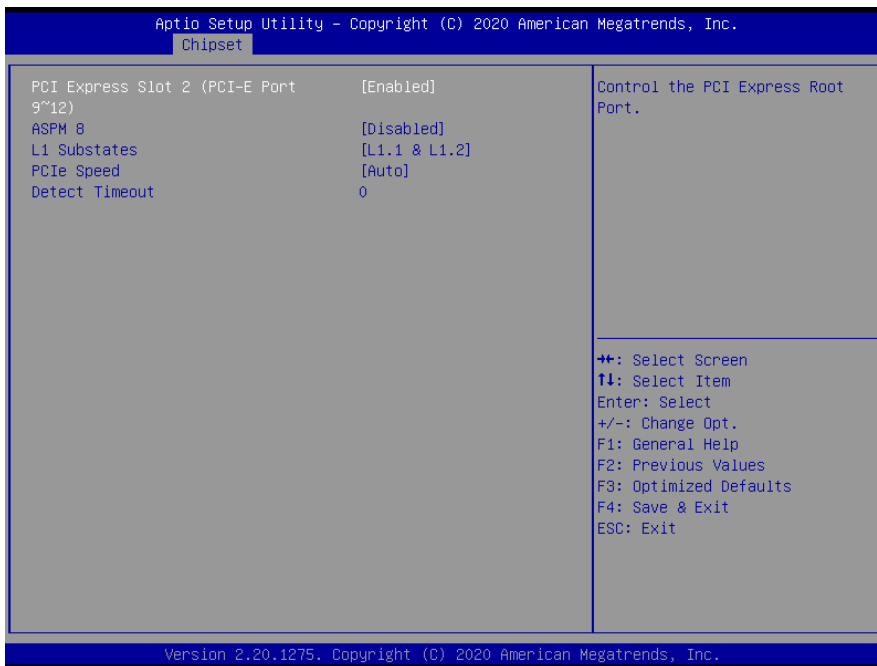

Item	Option	Description
PCI Express Slot 2 (PCI-E Port 9~12)	Disabled Enabled[Default],	Control the PCI Express Root Port.
ASPM 8	Disabled[Default] L0s L1 L0sL1 Auto	Set the ASPM Level: Force L0s – Force all links to L0s State AUTO – BIOS auto configure DISABLE – Disables ASPM.
L1 Substates	Disabled L1.1 L1.1 & L1.2[Default]	PCI Express L1 Substates settings.
PCIe Speed	Auto[Default] Gen1 Gen2 Gen3	Configure PCIe Speed
Detect Timeout	0[Default],	The number of milliseconds reference code will wait for link to exit Detect state for enabled ports before assuming there is no device and potentially disabling the port.

3.6.3.2.1.3 PCI Express Slot 3 (PCI-E Port 21~24)

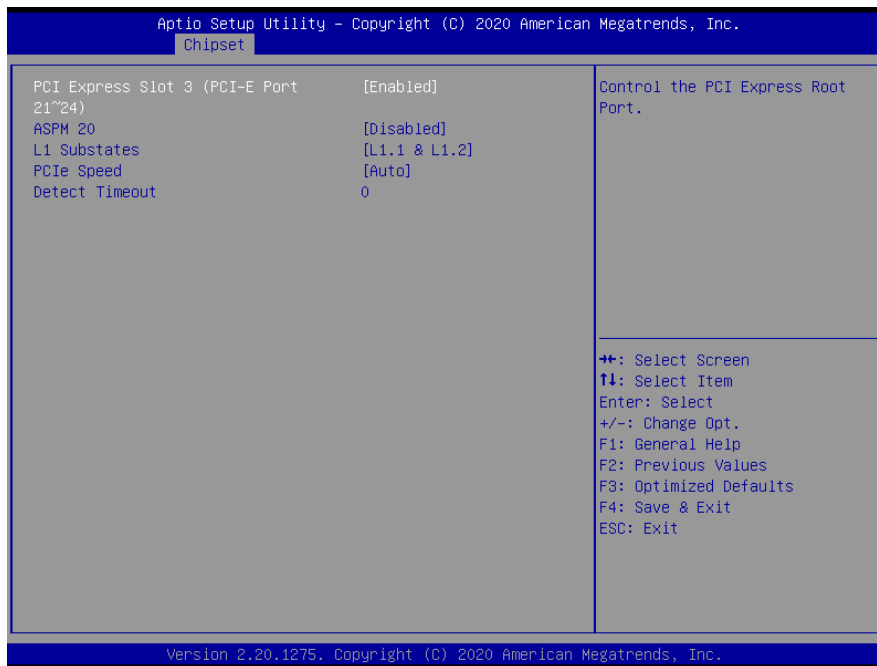

Item	Option	Description
PCI Express Slot 3 (PCI-E Port 21~24)	Disabled Enabled[Default],	Control the PCI Express Root Port.
ASPM 20	Disabled[Default] L0s L1 L0sL1 Auto	Set the ASPM Level: Force L0s – Force all links to L0s State AUTO – BIOS auto configure DISABLE – Disables ASPM.
L1 Substates	Disabled L1.1 L1.1 & L1.2[Default]	PCI Express L1 Substates settings.
PCIe Speed	Auto[Default] Gen1 Gen2 Gen3	Configure PCIe Speed
Detect Timeout	0[Default],	The number of milliseconds reference code will wait for link to exit Detect state for enabled ports before assuming there is no device and potentially disabling the port.

3.6.3.2.1.4 Intel I211/I210 LAN Chip (PCI-E Port 14)

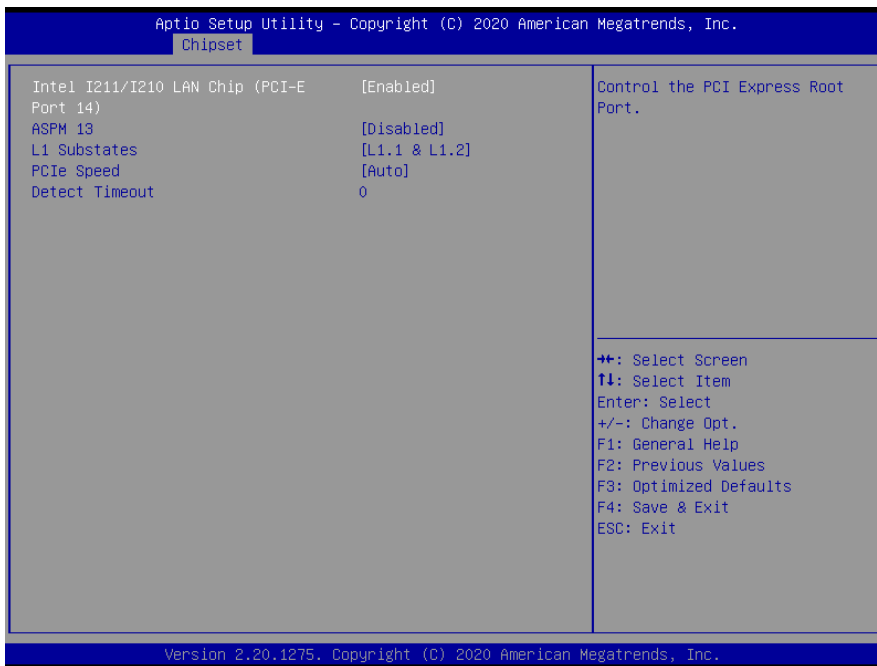

Item	Option	Description
Intel I211/I210 LAN Chip (PCI-E Port 14)	Disabled Enabled[Default],	Control the PCI Express Root Port.
ASPM 13	Disabled[Default] L0s L1 L0sL1 Auto	Set the ASPM Level: Force L0s – Force all links to L0s State AUTO – BIOS auto configure DISABLE – Disables ASPM.
L1 Substates	Disabled L1.1 L1.1 & L1.2[Default]	PCI Express L1 Substates settings.
PCIe Speed	Auto[Default] Gen1 Gen2 Gen3	Configure PCIe Speed
Detect Timeout	0[Default],	The number of milliseconds reference code will wait for link to exit Detect state for enabled ports before assuming there is no device and potentially disabling the port.

3.6.3.2.1.5 PCIE to PCI (PCI-E Port 19)

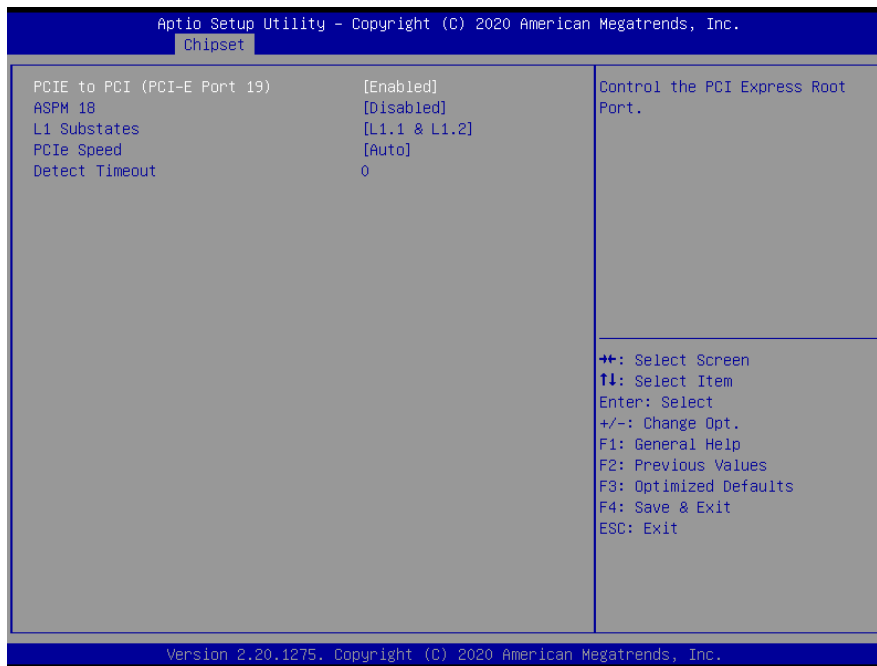

Item	Option	Description
PCIE to PCI (PCI-E Port 19)	Disabled Enabled[Default],	Control the PCI Express Root Port.
ASPM 18	Disabled[Default] L0s L1 L0sL1 Auto	Set the ASPM Level: Force L0s – Force all links to L0s State AUTO – BIOS auto configure DISABLE – Disables ASPM.
L1 Substates	Disabled L1.1 L1.1 & L1.2[Default]	PCI Express L1 Substates settings.
PCIe Speed	Auto[Default] Gen1 Gen2 Gen3	Configure PCIe Speed
Detect Timeout	0[Default],	The number of milliseconds reference code will wait for link to exit Detect state for enabled ports before assuming there is no device and potentially disabling the port.

3.6.3.2.1.6 PCIE to USB3.0 (PCI-E Port 20)

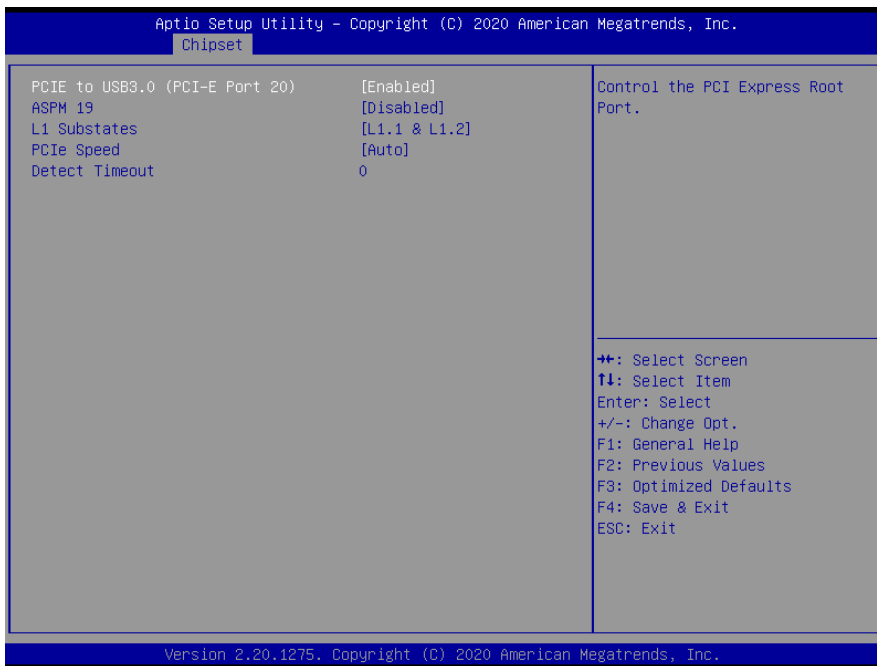

Item	Option	Description
PCIE to USB3.0 (PCI-E Port 20)	Disabled Enabled [Default] ,	Control the PCI Express Root Port.
ASPM 19	Disabled [Default] L0s L1 L0sL1 Auto	Set the ASPM Level: Force L0s – Force all links to L0s State AUTO – BIOS auto configure DISABLE – Disables ASPM.
L1 Substates	Disabled L1.1 L1.1 & L1.2 [Default]	PCI Express L1 Substates settings.
PCIe Speed	Auto [Default] Gen1 Gen2 Gen3	Configure PCIe Speed
Detect Timeout	0 [Default] ,	The number of milliseconds reference code will wait for link to exit Detect state for enabled ports before assuming there is no device and potentially disabling the port.

3.6.3.2.1 SATA And RST Configuration

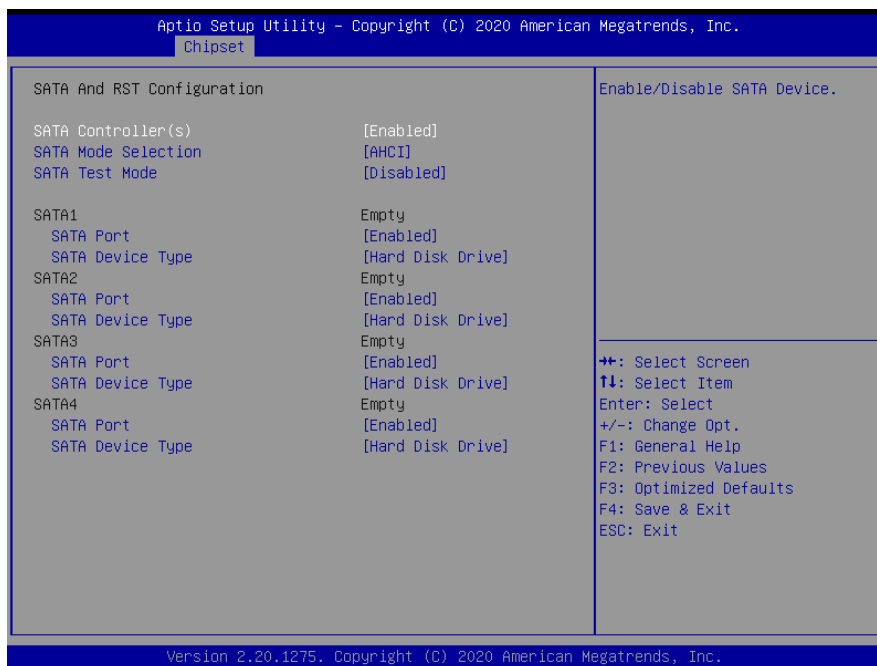

Item	Options	Description
SATA Configuration(S)	Enabled[Default], Disabled	Enable/Disable SATA Device.
SATA Mode Selection	AHCI[Default], RAID	Determines how SATA controller(s) operate.
SATA Test Mode	Enabled Disabled[Default],	Test Mode Enable/Disable (Loop Back).
SATA Port	Disabled Enabled[Default],	Enable or Disable SATA Port
SATA Device Type	Hard Disk Drive[Default], Solid State Drive	Identify the SATA port is connected to Solid State Drive or Hard Disk Drive.

3.6.3.2.3 HD Audio Configuration

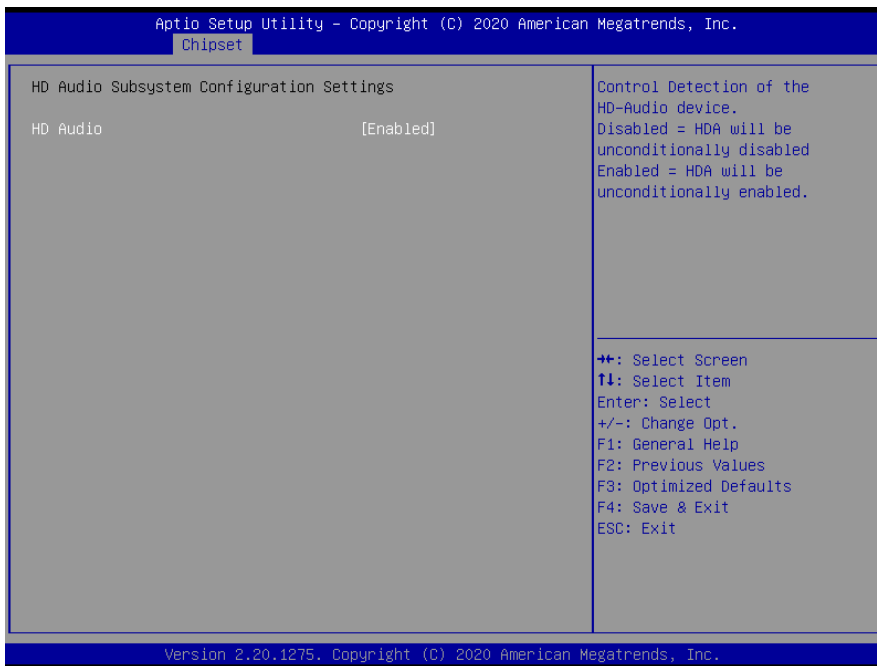

Item	Option	Description
HD Audio	Disabled Enabled[Default],	Control Detection of the HD-Audio device. Disabled = HDA will be unconditionally disabled Enabled = HAD will be unconditionally enabled.

3.6.3.3 Board Configuration

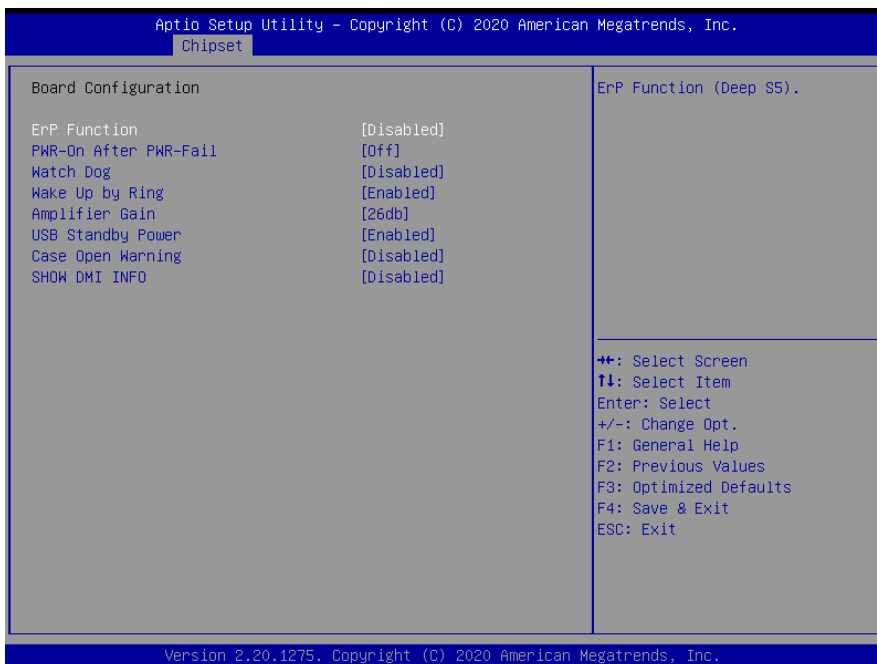

Item	Option	Description
ErP Function	Disabled Enabled[Default],	ErP Function (Deep S5).
PWR-On After PWR-Fail	Off[Default], On Last state	AC loss resume.
Watch Dog	Disabled[Default], 30 sec 40 sec 50 sec 1 min 2 min 10 min 30 min	Select WatchDog.
Wake Up by Ring	Disabled Enabled[Default],	Wake Up by Ring from S3/S4/S5
Amplifier Gain	20db 26db[Default], 32db 36db	Amplifier Gain
USB Standby Power	Disabled Enabled[Default],	Enable/Disable USB Standby Power during S3/S4/S5
Case Open Warning	Disabled[Default], Enabled	Enable/Disable Case Open Warning
SHOW DMI INFO	Disabled[Default], Enabled	SHOW DMI INFO

3.6.4 Security

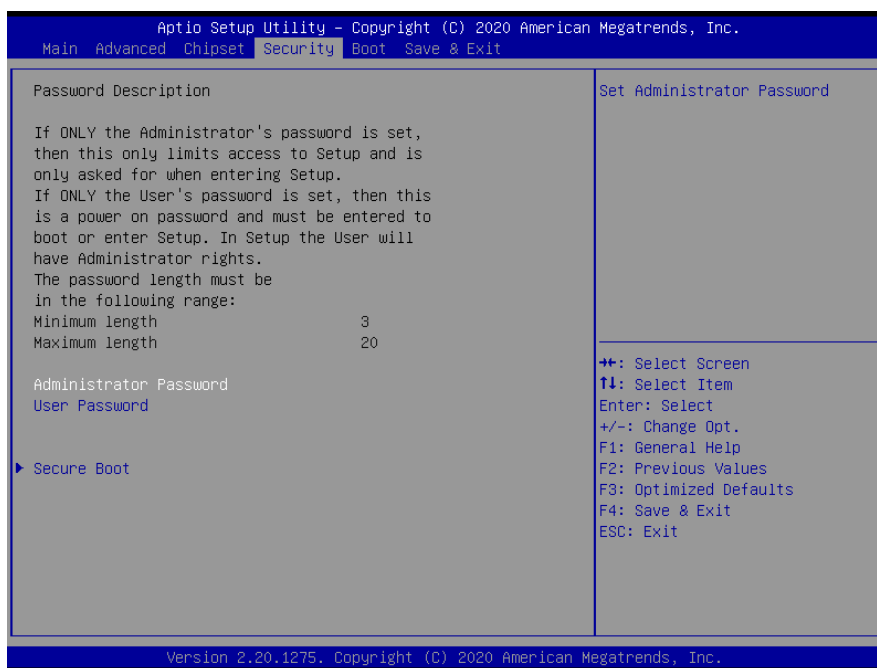

EAX-C246BP User's Manual

Item	Description
Administrator Password	Set Administrator Password
User Password	Set User Password

3.6.4.1 Secure Boot



Item	Option	Description
Secure Boot	Disabled Enabled[Default],	Secure Boot feature is Active if Secure Boot is Enabled, Platform Key(PK) is enrolled and the System is in User mode. The mode change requires platform reset
Secure Boot Mode	Standard Custom[Default],	Secure Boot mode options: Standard or Custom. In Custom mode, Secure Boot Policy variables can be configured by a physically present user without full authentication

3.6.4.1.1 Restore Factory Keys

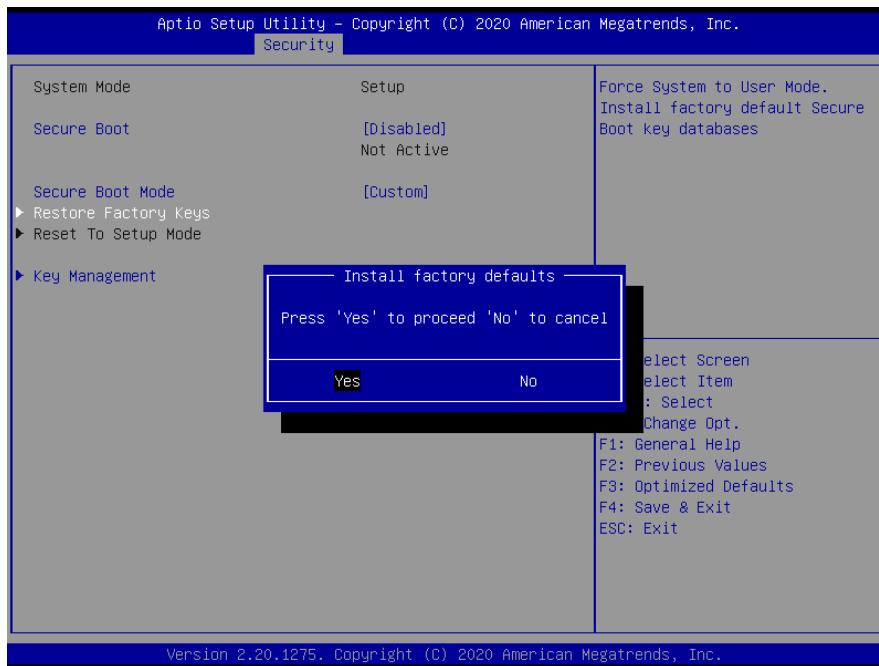

3.6.4.1.2 Key Management

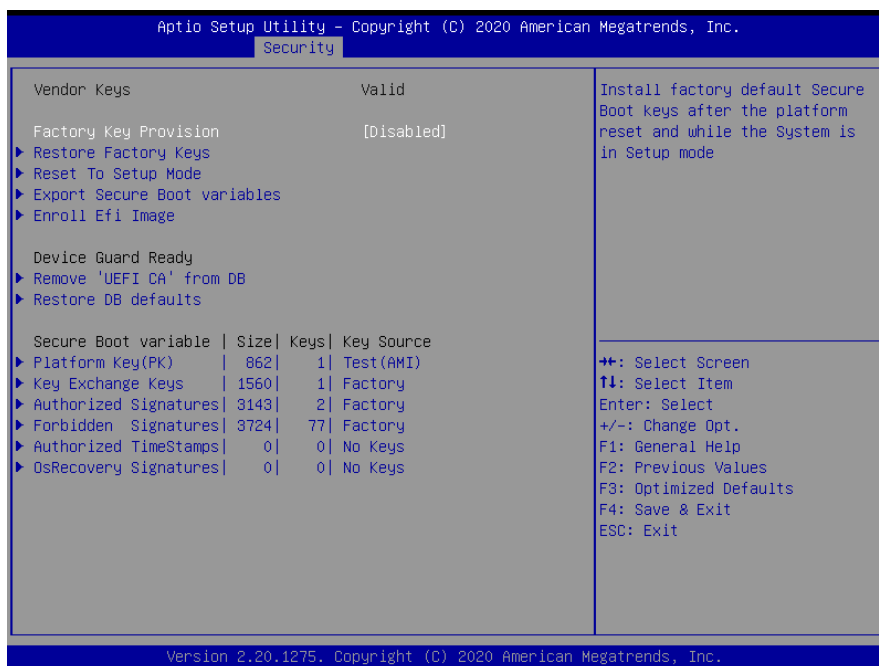

EAX-C246BP User's Manual

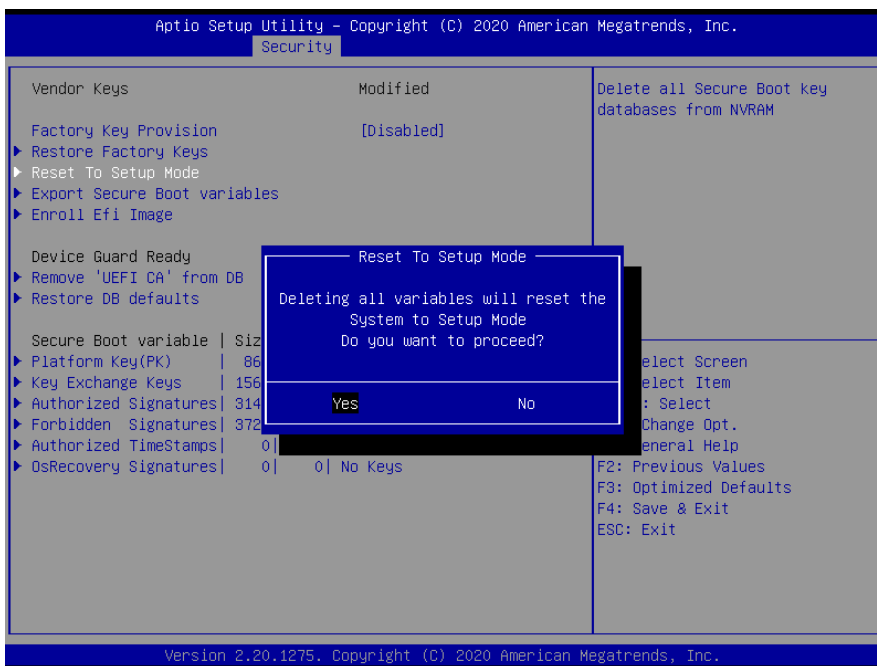
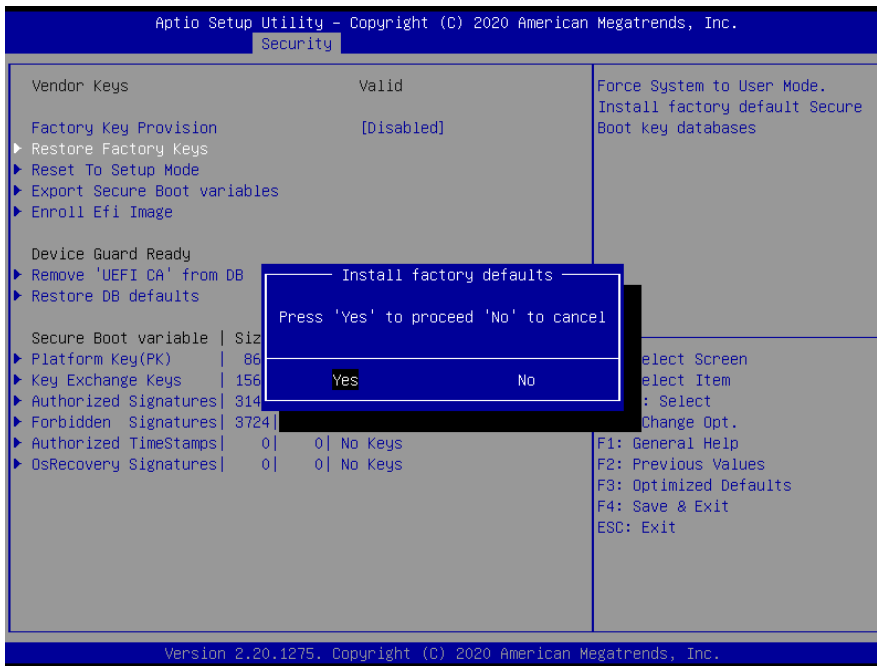

3.6.5 Boot

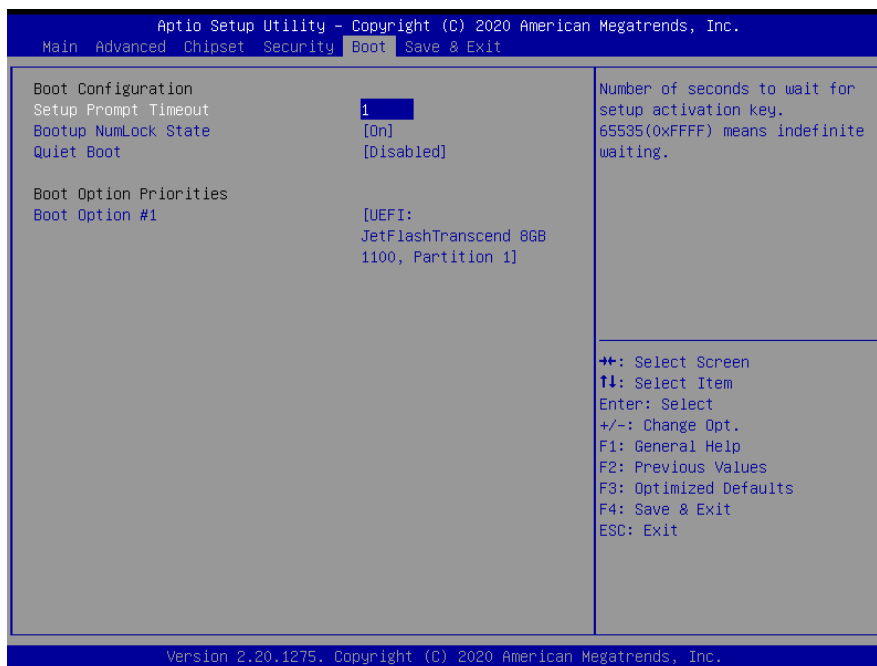

Item	Option	Description
Setup Prompt Timeout	1	Number of seconds to wait for setup activation key. 65535(0xFFFF) means indefinite waiting.
Bootup NumLock State	On[Default] Off	Select the keyboard NumLock state.
Quiet Boot	Disabled[Default] Enabled	Enable or disable Quiet Boot option.
Boot Option #1	Sets the system boot order	

3.6.6 Save & Exit

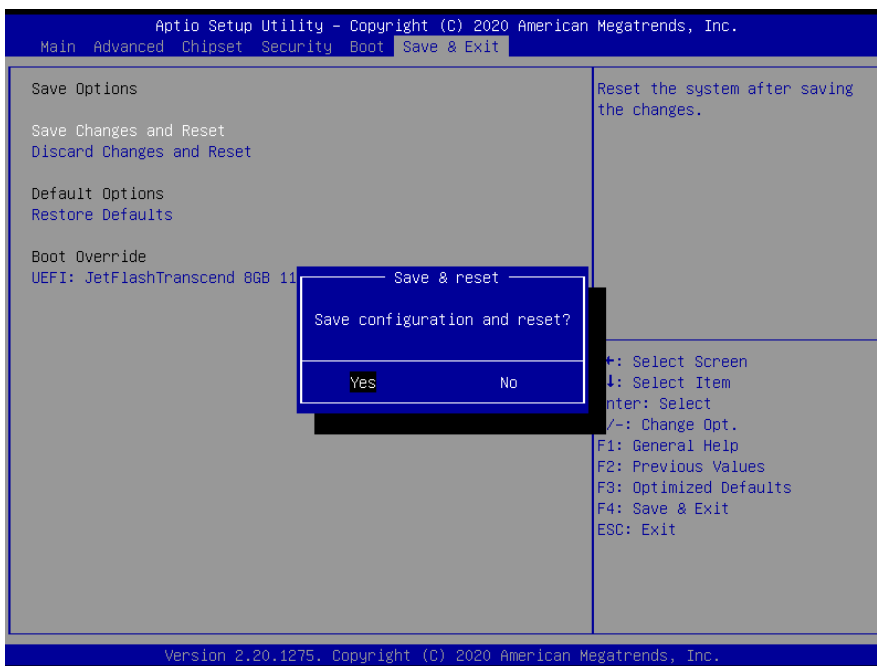
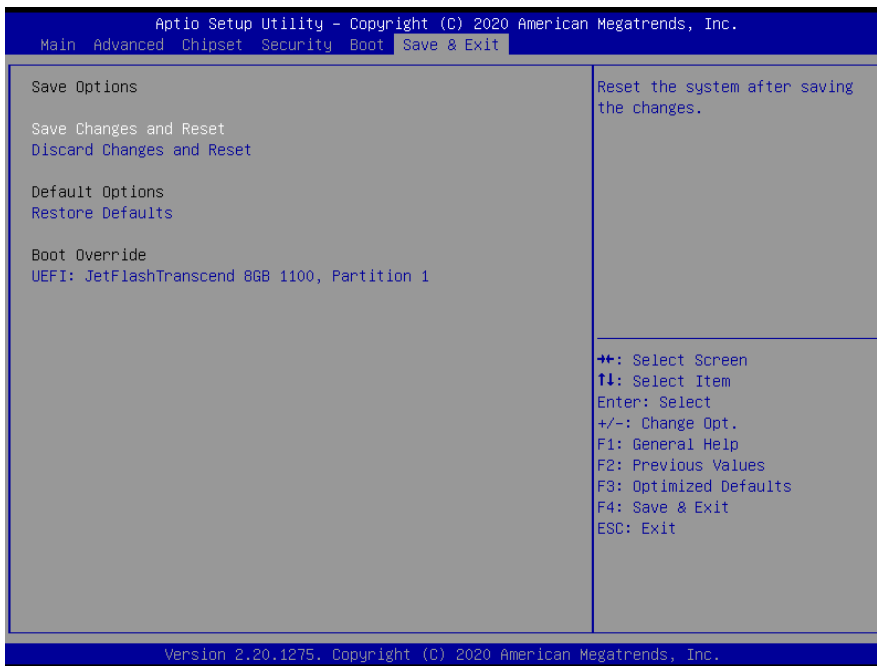

3.6.5.1 Save Changes and Reset

Reset the system after saving the changes.

3.6.5.2 Discard Changes and Reset

Any changes made to BIOS settings during this session of the BIOS setup program are discarded. The setup program then exits and reboots the controller.

3.6.5.3 *Restore Defaults*

This option restores all BIOS settings to the factory default. This option is useful if the controller exhibits unpredictable behavior due to an incorrect or inappropriate BIOS setting.

3.6.5.4 *Launch EFI Shell from filesystem device*

Attempts to Launch EFI Shell application (Shellx64.efi) from one of the available filesystem devices.

4. Drivers Installation



Note: Installation procedures and screen shots in this section are for your reference and may not be exactly the same as shown on your screen.

4.1 Install Chipset Driver

All drivers can be found on the Avalue Official Website:

<http://www.avalue.com.tw>.



Note: The installation procedures and screen shots in this section are based on Windows 10 operation system. If the warning message appears while the installation process, click Continue to go on.

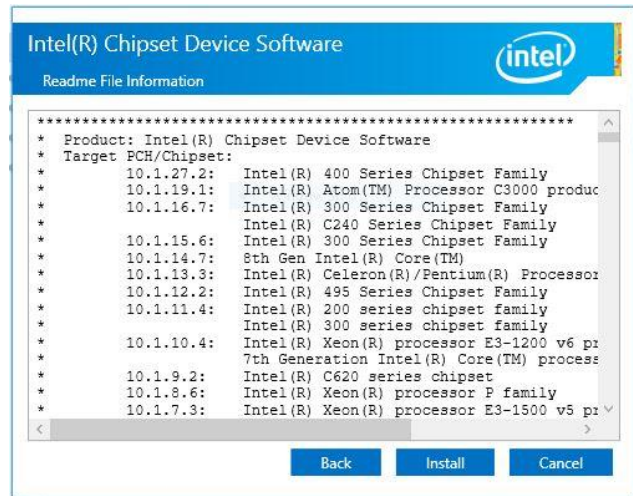

Step 3. Click Install.



Step 1. Click Next.



Step 4. Complete setup.



Step 2. Click Accept.

4.2 Install VGA Driver

All drivers can be found on the Avalue Official Website:
<http://www.avalu.com.tw>.



Note: The installation procedures and screen shots in this section are based on Windows 10 operation system.

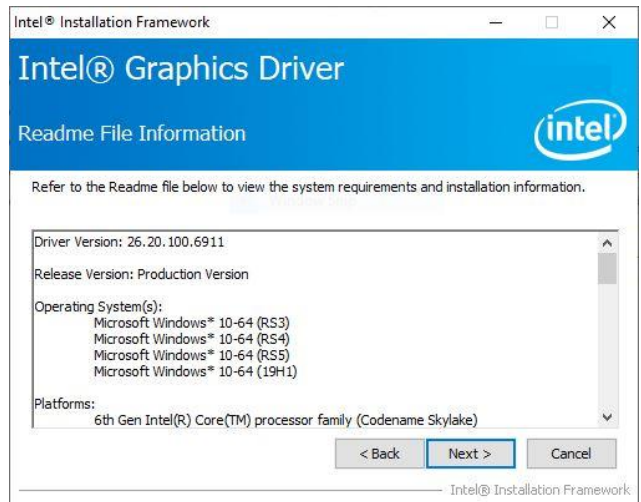

Step 3. Click Next.

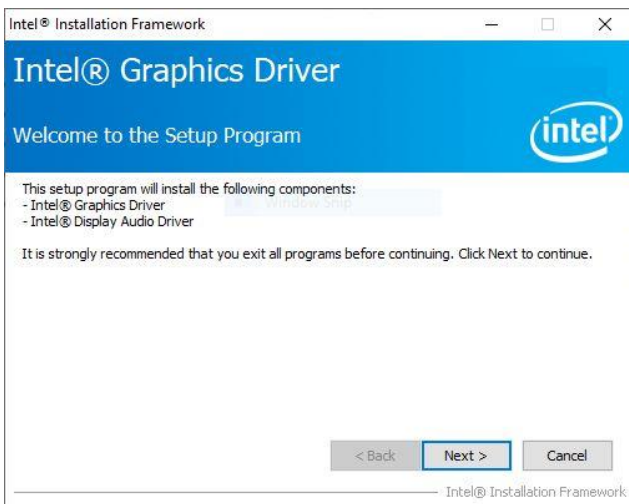

Step 1. Click Next to continue installation.

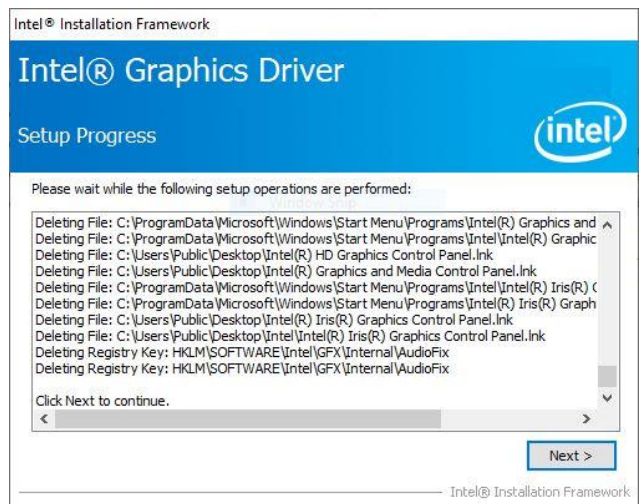

Step 4. Click Next.

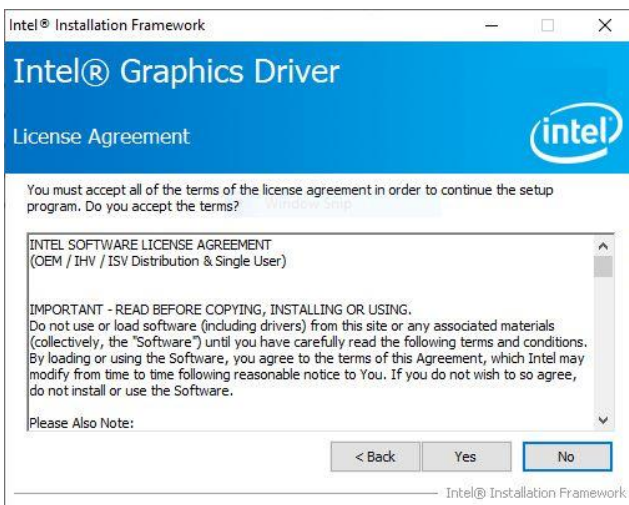

Step 2. Click Yes.

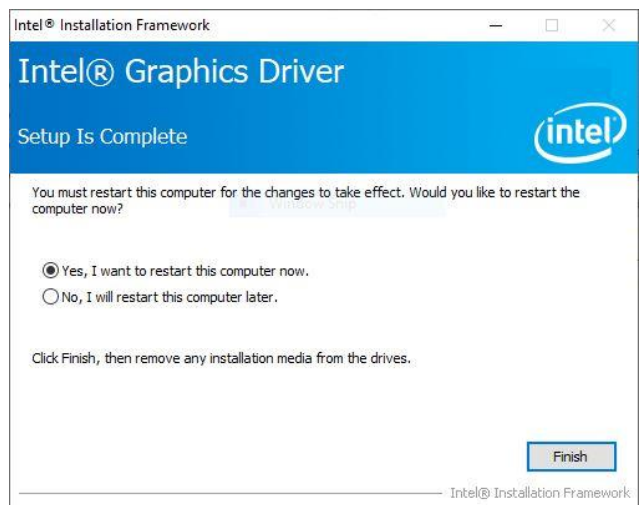

Step 5. Click Finish to complete setup.

SUPPORTED PRODUCTS:

The Intel® Graphics Driver contains support for the following Intel Chipsets/Processors with the following

graphic support: Intel®, Iris® Pro and Intel® HD graphics:

- 6th Gen Intel® Core™ processor family (codename Skylake) (Workstation-Xeon)

4.3 Install ME Driver

All drivers can be found on the Avalue Official Website:

<http://www.avalue.com.tw>.



Note: The installation procedures and screen shots in this section are based on Windows 10 operation system.



Step 1. Click **Next** to continue setup.



Step 2. Click **Next**.

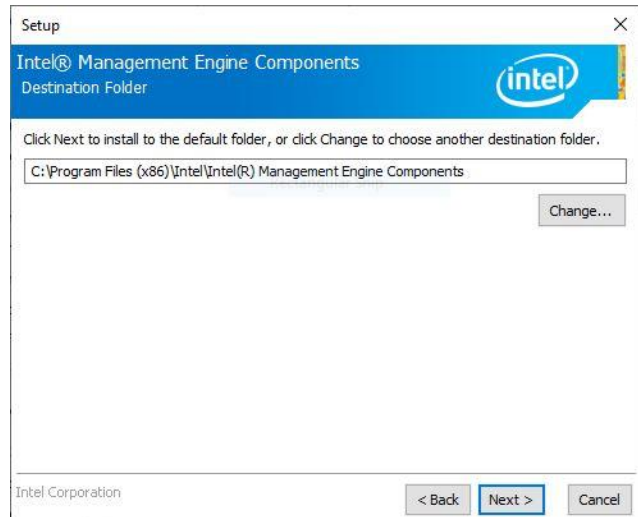

Step 3. Click **Next**

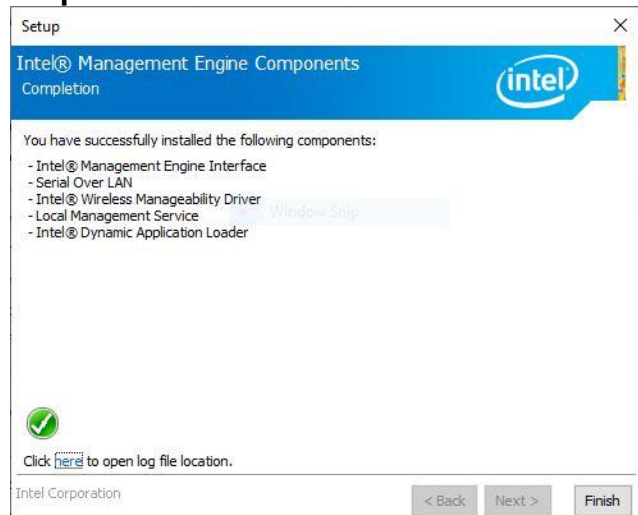

Step 4. Click **Finish** to complete the setup

4.4 Install Audio Driver (For Realtek ALC888S HD Audio)

All drivers can be found on the Avalue Official Website:

<http://www.avalue.com.tw>.



Note: The installation procedures and screen shots in this section are based on Windows 10 operation system.

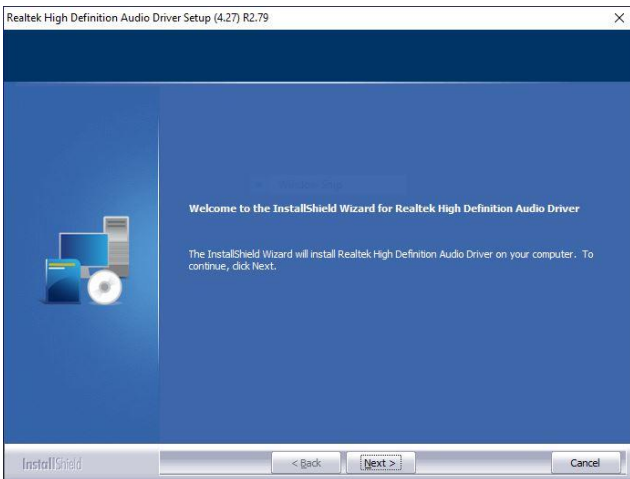

Step1. Click **Next** to Install.

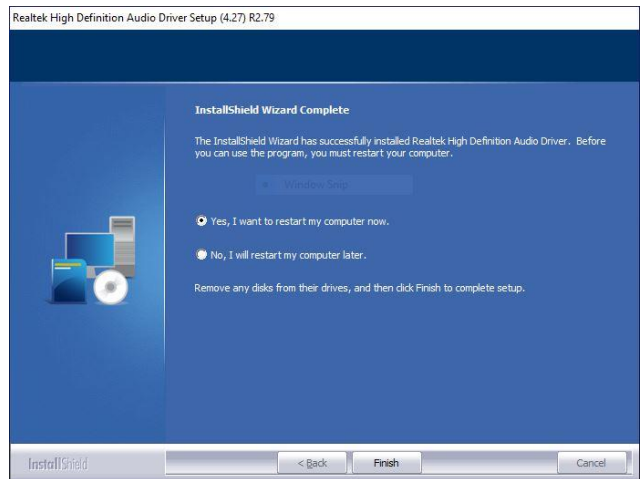

Step 2. Select **Finish** to complete Installation.

4.5 Install LAN Driver

All drivers can be found on the Avalue Official Website:
<http://www.avalue.com.tw>.



Note: The installation procedures and screen shots in this section are based on Windows 10 operation system.

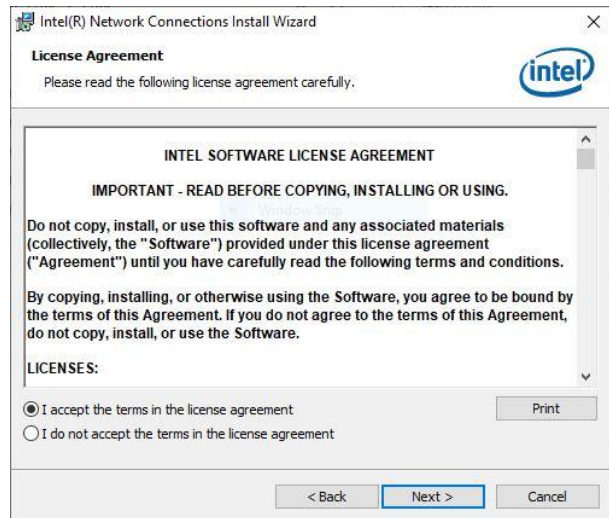

Step 3. Click Next.

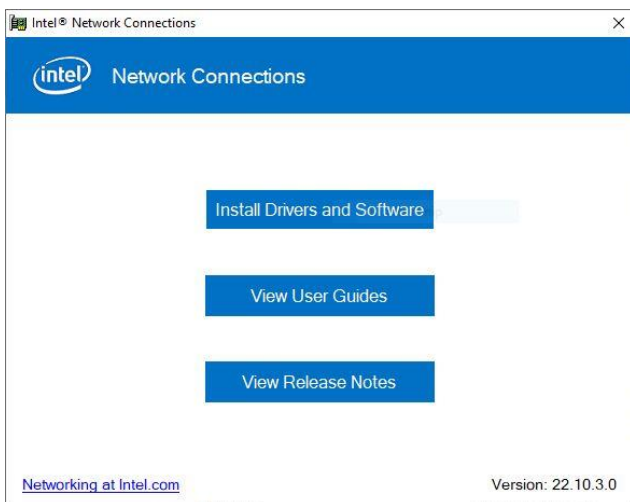

Step 1. Click Install Drivers and Software

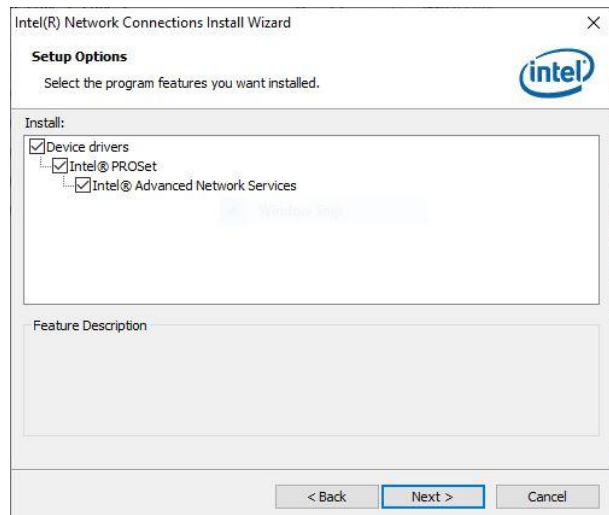

Step 4. Click Next.

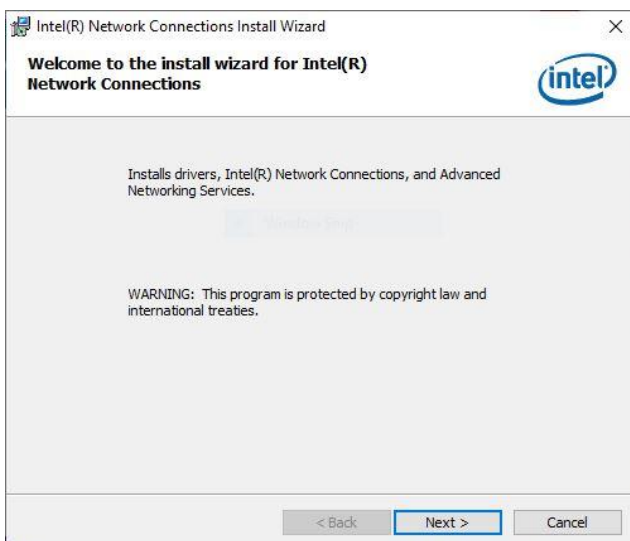

Step 2. Click Next to continue installation.

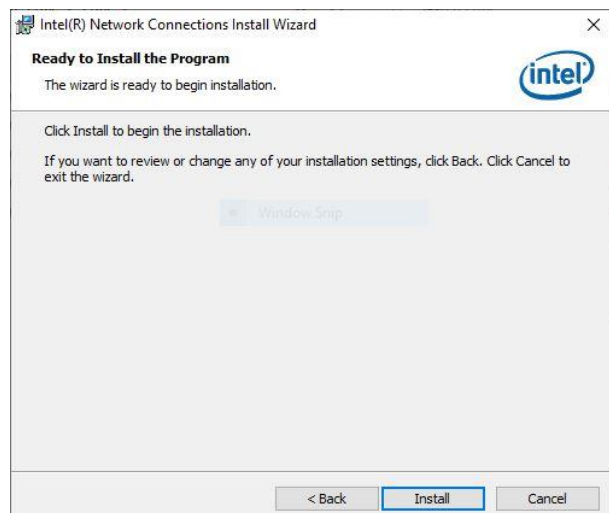

Step 5. Click Install.

EAX-C246BP User's Manual

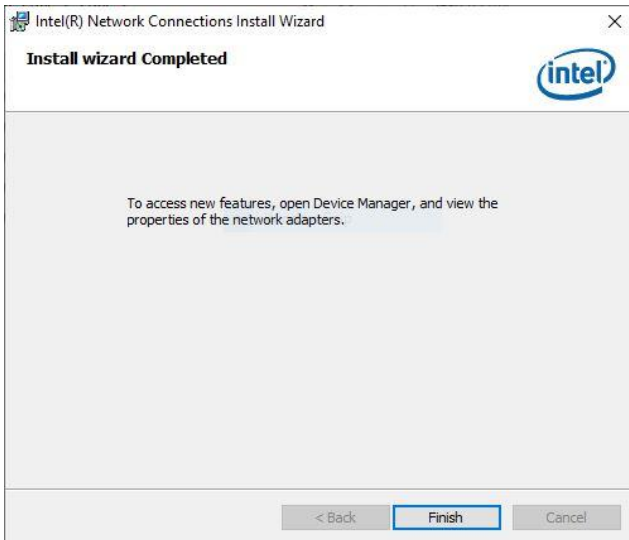

Step 6. Click **Finish** to complete setup.

4.6 Install RST Driver

All drivers can be found on the Avalue Official Website:
<http://www.avalu.com.tw>.



Note: The installation procedures and screen shots in this section are based on Windows 10 operation system.

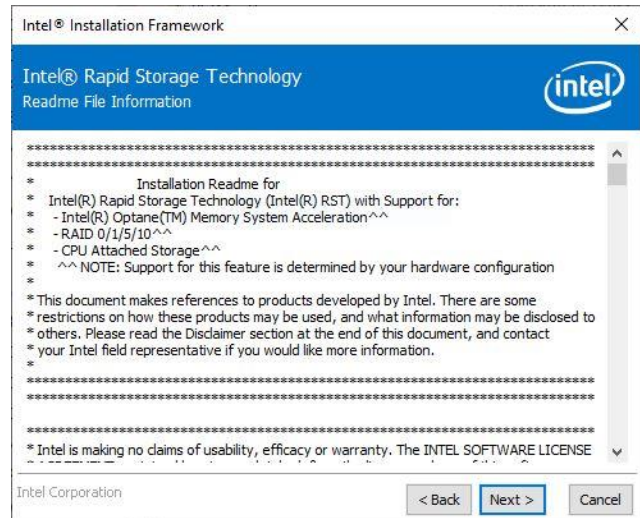

Step 3. Click Next.

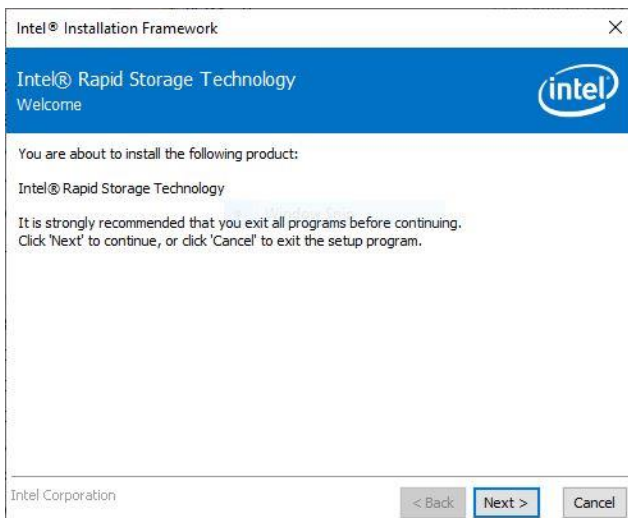

Step 1. Click Next to continue installation.

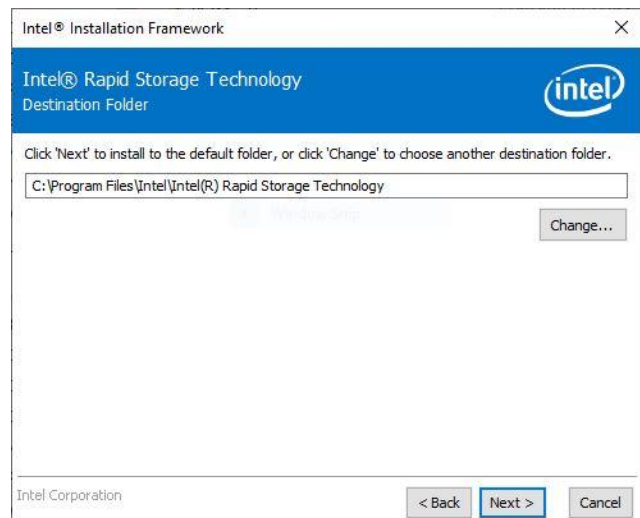

Step 4. Click Next.

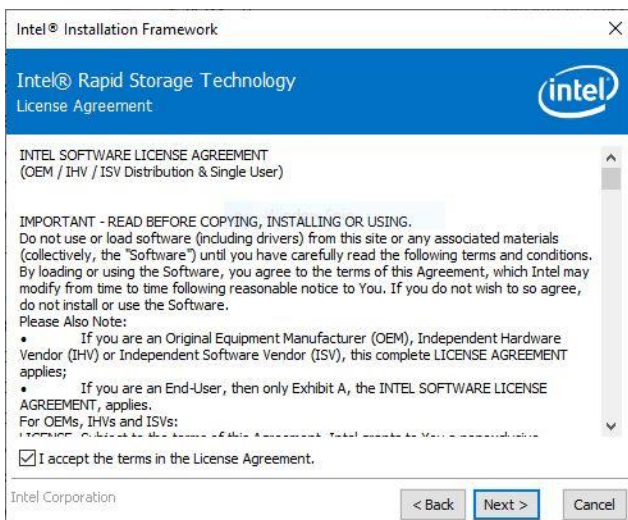

Step 2. Click Next.

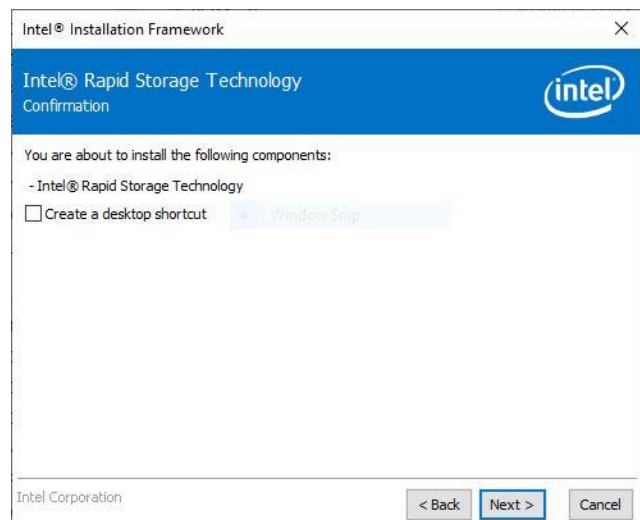

Step 5. Click Finish to complete setup.

EAX-C246BP User's Manual

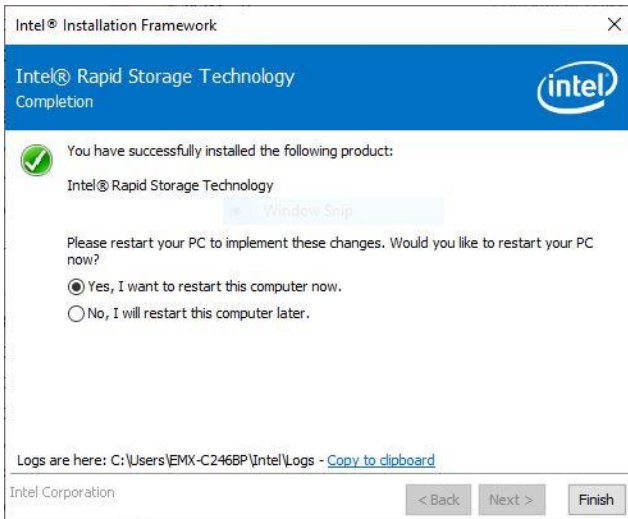

Step 6. Click **Finish** to complete setup.

4.7 Install Serial IO Driver

All drivers can be found on the Avalue Official Website:

<http://www.avalu.com.tw>.



Note: The installation procedures and screen shots in this section are based on Windows 10 operation system.

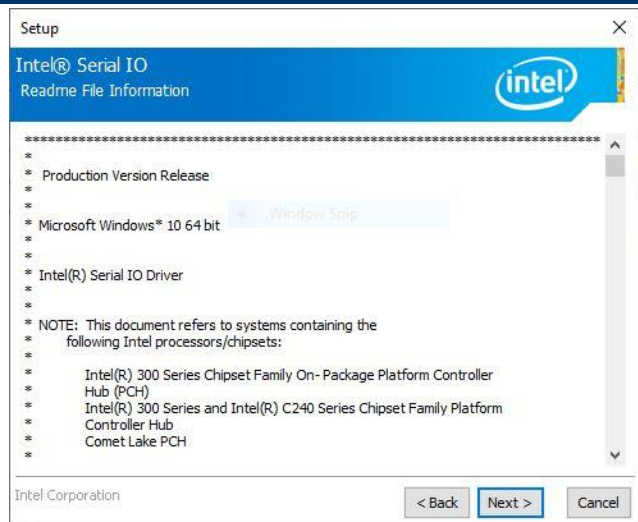

Step 3. Click Next.

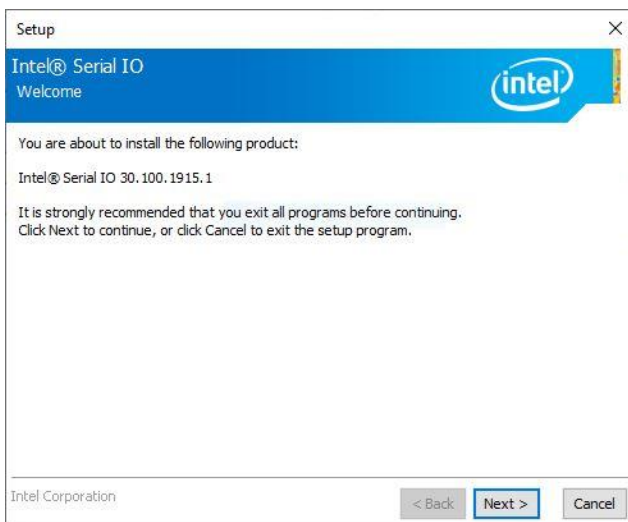

Step 1. Click Next to continue installation.



Step 4. Click Next.



Step 2. Click Next.



Step 5. Click Finish to complete setup.

5. Mechanical Drawing



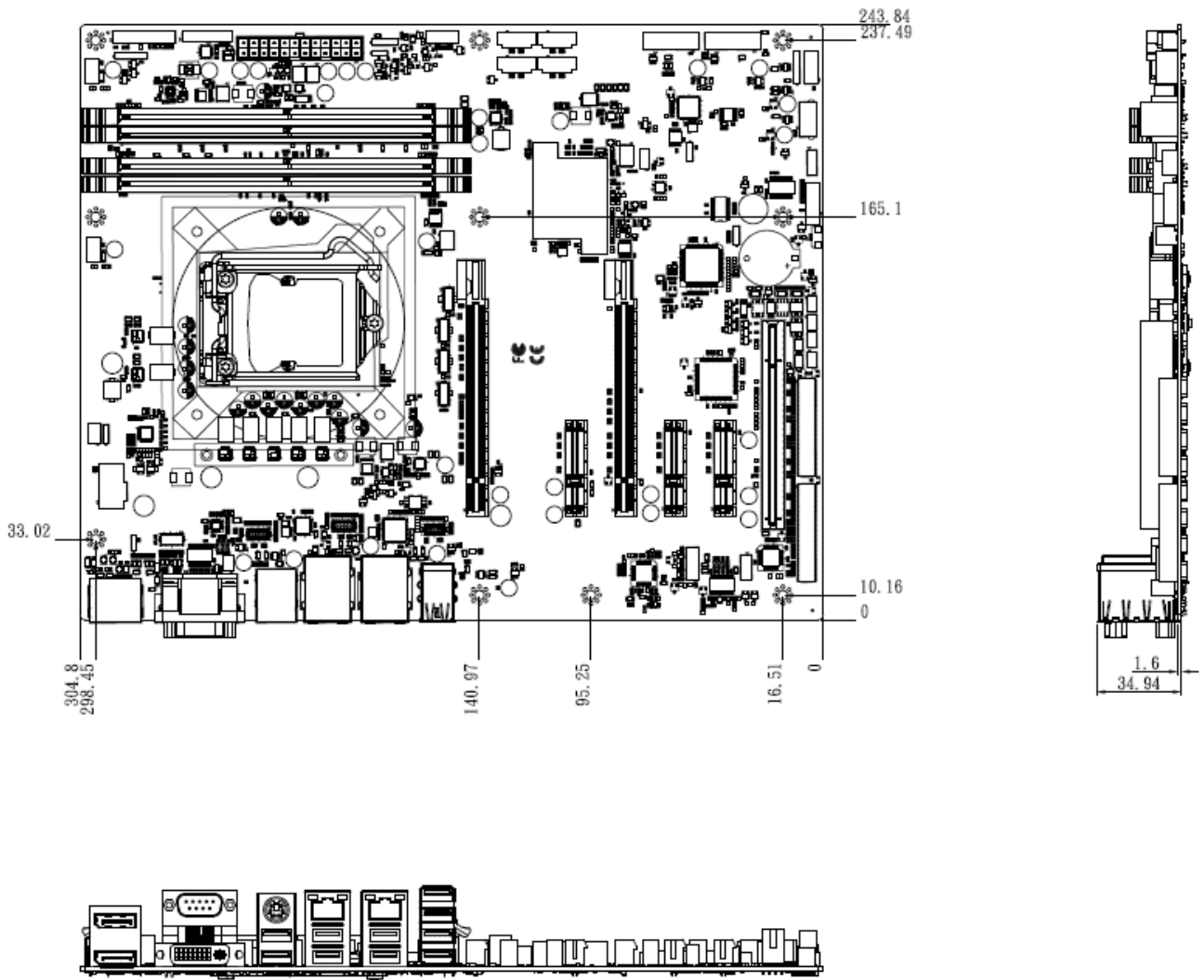

Unit: mm

EAX-C246BP User's Manual

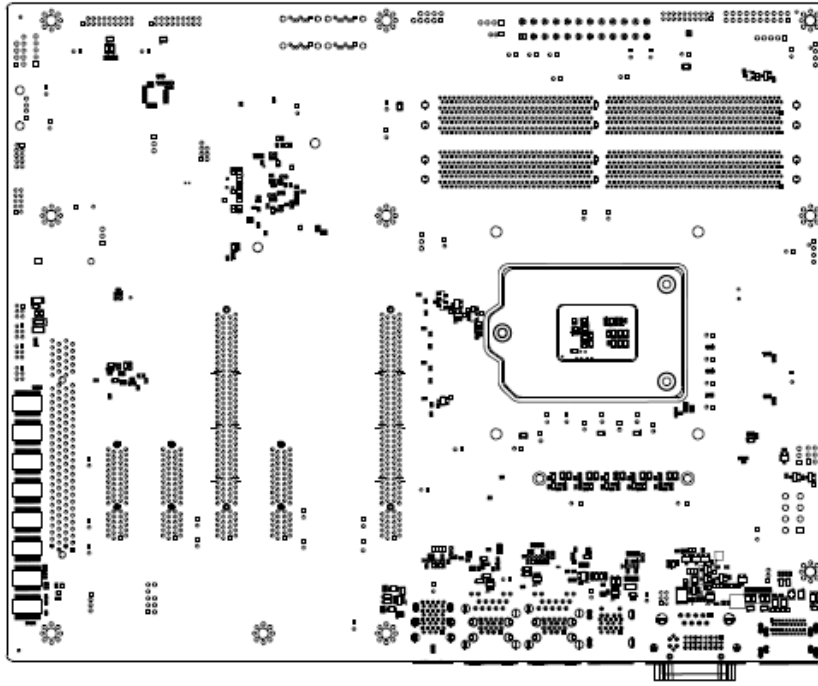

Unit: mm

