



***AXIOMTEK***

**NA363R**

**Network Appliance**

**User's Manual**



## **Disclaimers**

This manual has been carefully checked and believed to contain accurate information. AXIOMTEK Co., Ltd. assumes no responsibility for any infringements of patents or any third party's rights, and any liability arising from such use.

AXIOMTEK does not warrant or assume any legal liability or responsibility for the accuracy, completeness or usefulness of any information in this document. AXIOMTEK does not make any commitment to update the information in this manual.

AXIOMTEK reserves the right to change or revise this document and/or product at any time without notice.

No part of this document may be reproduced, stored in a retrieval system, or transmitted, in any form or by any means, electronic, mechanical, photocopying, recording, or otherwise, without the prior written permission of AXIOMTEK Co., Ltd.

**©Copyright 2019 AXIOMTEK Co., Ltd.  
All Rights Reserved  
June 2019, Version A1  
Printed in Taiwan**

## Safety Approvals

- ◆ CE Marking
- ◆ FCC Class A

### ◆ FCC Compliance

This equipment has been tested and complies with the limits for a Class A digital device, pursuant to Part 15 of the FCC Rules. These limits are designed to provide reasonable protection against harmful interference in a residential installation. If not installed and used in accordance with proper instructions, this equipment might generate or radiate radio frequency energy and cause harmful interference to radio communications. However, there is no guarantee that interference will not occur in a particular installation. If this equipment does cause harmful interference to radio or television reception, which can be determined by turning the equipment off and on, the user is encouraged to try to correct the interference by one or more of the following measures:

Reorient or relocate the receiving antenna.

Increase the separation between the equipment and receiver.

Connect the equipment into an outlet on a circuit different from that to which the receiver is connected.

Consult the dealer or an experienced radio/TV technician for help.

Shielded interface cables must be used in order to comply with emission limits.

## Safety Precautions

Before getting started, read the following important cautions.

1. Be sure to ground yourself to prevent static charge when installing the internal components. Use a grounding wrist strap and place all electronic components in any static-shielded devices. Most electronic components are sensitive to static electrical charge.
2. Disconnect the power cords from the **NA363R Series** before making any installation. Be sure both the system and the external devices are turned OFF. Sudden surge of power could ruin sensitive components. Make sure the **NA363R Series** is properly grounded.
3. Do not open the system's top cover. If opening the cover for maintenance is a must, only a trained technician is allowed to do so. Integrated circuits on computer boards are sensitive to static electricity. To avoid damaging chips from electrostatic discharge, observe the following precautions:
  - Before handling a board or integrated circuit, touch an unpainted portion of the system unit chassis for a few seconds. This will help to discharge any static electricity on your body.
  - When handling boards and components, wear a wrist-grounding strap, available from most electronic component stores.

## Trademarks Acknowledgments

AXIOMTEK is a trademark of AXIOMTEK Co., Ltd.

IBM, PC/AT, PS/2, VGA are trademarks of International Business Machines Corporation.

Intel<sup>®</sup> and Pentium<sup>®</sup> are registered trademarks of Intel Corporation. MS-DOS, Microsoft C and QuickBASIC are trademarks of Microsoft Corporation.

Other brand names and trademarks are the properties and registered brands of their respective owners.

# Table of Contents

---

Disclaimers.....	ii
Safety Approvals .....	iii
Safety Precautions .....	iv
<b>CHAPTER 1 INTRODUCTION .....</b>	<b>1</b>
1.1    General Description.....	1
1.2    Features.....	1
1.3    Specifications .....	2
1.3.1    System .....	2
1.3.2    Mechanical / Environmental .....	3
1.4    Dimensions and Outlines .....	4
1.5    I/O Outlets .....	5
1.5.1    Front Panel for NA363R.....	5
1.5.2    Rear Panel for NA363R.....	7
<b>CHAPTER 2 HARDWARE DESCRIPTION .....</b>	<b>9</b>
2.1    Checklist.....	9
2.2    Memory Module (UDIMM/RDIMM) and HDD .....	9
2.3    Board Layout.....	11
2.4    Jumper Settings.....	13
2.4.1    Clear CMOS Jumper (JP2) .....	13
2.4.2    LAN Bypass Control Selection (JP7, JP8, JP9) .....	14
2.4.3    TACT SW1 Selection (JP6).....	15
2.5    Connectors .....	16
2.5.1    LCM Connector .....	17
2.5.2    Digital Input / Output Connector (DIO1) .....	17
2.5.3    Serial Port2 Connector (COM2).....	18
2.5.4    FAN Connector (FAN1, FAN2, FAN3) .....	18
2.5.5    Serial ATA Connector: (SATA1, SATA2, SATA3, SATA4).....	18
2.5.6    SATA Power Connector: (CN2, CN3) .....	19
2.5.7    Mini Card Connector (CN5).....	19
2.5.8    Mini Card Connector (CN6).....	20
2.5.9    Case Open Connector (CN7) .....	21
2.5.10    DC-In Power Jack (CN11).....	21
2.5.11    4P Wafer Power Input Connector (ATX2).....	21
2.5.12    Power Switch Connector desktop system (ATX1) .....	21
2.5.13    Serial Port for Console (COM1).....	22
2.5.14    USB port Connector (USB1).....	22
2.5.15    LED1~11 .....	23
2.5.16    Front Panel Bezel Connector (JP1).....	24
<b>CHAPTER 3 AMI BIOS SETUP UTILITY .....</b>	<b>25</b>
3.1    Starting .....	25
3.2    Navigation Keys .....	25
3.3    Main Menu .....	26
3.4    Advanced Menu.....	27
3.5    IntelRCSetup .....	52

3.6	Security Menu .....	58
3.7	Boot Menu .....	59
3.8	Save & Exit Menu .....	63
<b>APPENDIX A LAN BYPASS CONFIGURATION .....</b>		<b>71</b>
	About LAN Bypass .....	71
	LAN Bypass Register Configuration .....	72
<b>APPENDIX B WDT TIMER FOR SYSTEM RESET.....</b>		<b>77</b>
<b>APPENDIX C LAN MODULE EXPANSION .....</b>		<b>79</b>
	LAN Bypass Control Jumper (JP2/JP3) .....	80
<b>APPENDIX D WARNING.....</b>		<b>89</b>

# CHAPTER 1

## INTRODUCTION

This chapter contains general information and detailed specifications of the **NA363R** Network Appliance Server. Chapter 1 contains the following sections:

- **General Description**
- **Features**
- **Specifications**
- **Dimensions and Outlines**
- **I/O Outlets**

### 1.1 General Description

The NA363R is a 1U rack mount network security hardware platform for VPN, firewall and other network security applications, which consists can support of Intel<sup>®</sup> ATOM C3000 family processors. This platform supports the 1U rack mount form factor, and the system supports DDR4 U-DIMM/R-DIMM memory up to maximum 128 GB. In the meantime, the platform also can support 6 Gigabit LAN ports which can provide best throughput. For the purpose to store event log data, it can deploy two 2.5" SATA3 HDD, and one mSATA. This platform can be easily enabled through application programs to make a user-friendly appliance for customers, and provide the highest ever performance of encryption and decryption.

### 1.2 Features

Low power and high performance for network security field applications. NA363R series supports Intel<sup>®</sup> ATOM C3000 family processors.

- Supports six 10/100/1000Mbps Ethernet ports
- Supports BIOS redirected to COM port features
- Supports two 2.5" SATA Hard Disk
- Supports one mSATA
- Support 4 U-DIMM/R-DIMM, up to 128GB memory
- Reasonable computing performance and throughput for processor and LAN ports
- Suitable for Network Appliance; VPN, network bandwidth controller, firewall and UTM

## 1.3 Specifications

### 1.3.1 System

- **System CPU**
  - Intel<sup>®</sup> C3000 family processors. (C3558/C3758 in default, other sku for optional)
- **BIOS**
  - AMI SPI flash BIOS
- **System Memory**
  - Four DDR4 U-DIMM/R-DIMM, non-buffer non-ECC/ECC memory, up to 128GB
- **Storage Interface**
  - Two 2.5" SATA3 HDD
  - One mSATA
- **Expansion Slot**
  - Two PCI Express Mini Card Socket
  - One Full size, Support USB & M-SATA(default)
  - One Full size, Support USB & PCIe(default)
  - One NIC module for optional (C3758/C3958 support only ,due to PCIe lens limitation)
- **Network Interface**
  - Six 10/100/1000Mbps Ethernet (Intel<sup>®</sup> i210)
  - Two groups LAN by pass support latch relay for optional (One pair in default)
- **Watchdog Timer**
  - Two pairs LAN by pass :8 levels,1-64 seconds
  - One for system reset: 255 levels,1-255 sec
- **USB**
  - Two USB2.0 ports in the front side
- **Console**
  - RS-232 Console port is the front side(RJ-type)
- **Power**
  - AC/DC 120W open frame
- **OS Compatibility**
  - Yocto, Linux, Windows Server 2012 R2, Windows Server 2016.



### 1.3.2 Mechanical / Environmental

- **Form Factor**
  - 1U Rack mount
- **LED**
  - Power, HDD, Link/Act with transfer rate(LAN ports)
  - LAN by pass LED and programmable LED
- **Operation Temperature**
  - 0°C ~ 45°C (32°F ~ 113°F)
- **Storage Temperature**
  - -20°C ~ 70°C (-4°F ~ 158°F)
- **Humidity**
  - 10% - 95% RH, non-condensing
- **Chassis Material**
  - Steel
- **Dimensions**
  - 44mm (1.73") (H) x 430mm (16.93") (W) x 250mm (9.84")(D)
- **Weight (Net/Gross)**
  - 3.5 kg/ 4.5 kg



**NOTE:** All specifications and images are subject to change without notice.

## 1.4 Dimensions and Outlines

### NA363R

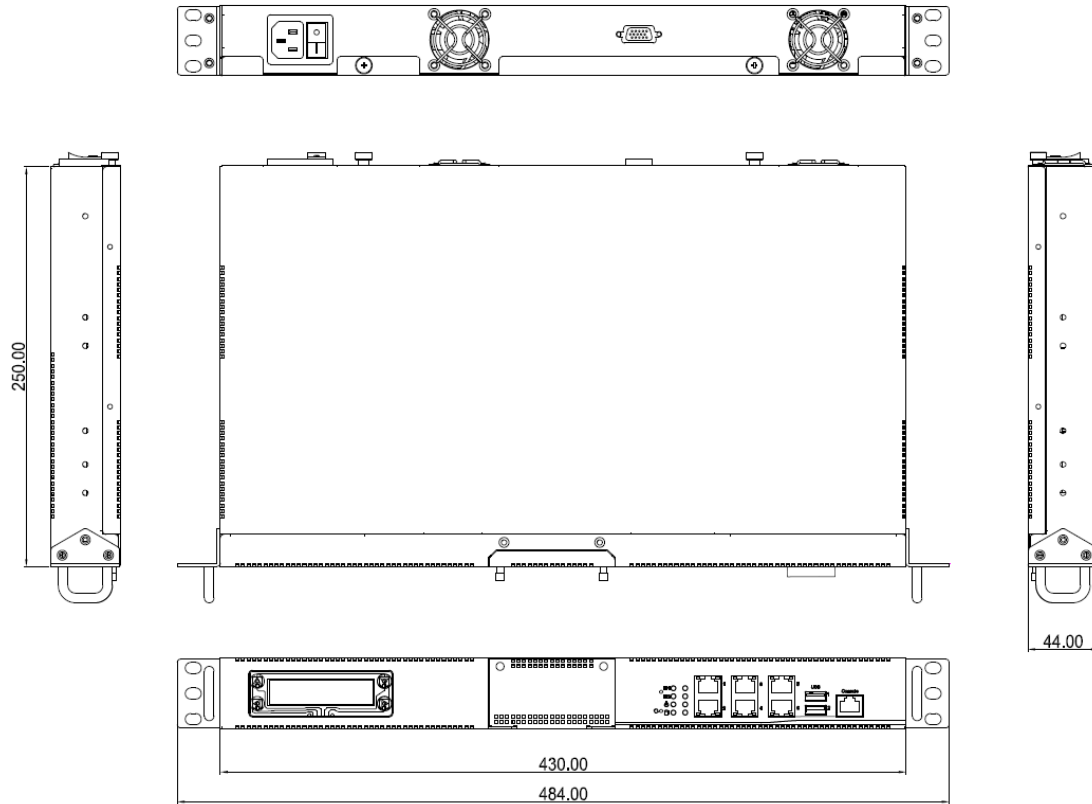

## 1.5 I/O Outlets

Locate the front panel I/O outlets on the **NA363R Series** server to connect serial and Ethernet interface devices.

### 1.5.1 Front Panel for NA363R



- **Power LED (Green)**  
LED light up when the server is powered on to perform diagnostic tests and proper operation checking.
- **HDD LED (Green)**  
LED flashes when HDD is transmitting or receiving data.
- **Programmable LED GPIO1, GPIO2, GPIO3, GPIO4 (Green)**  
The LEDs are controlled by programmable GPIO. A sample code will be provided that allow users to define their own function.
- **“Default” Tact Switch**  
The sample code will be provided that allows users to define their own function. For example, when the system has any problems, this switch can support to reset it to the customer's OS default settings if our customer's OS supports this application.
- **“Reset” Tact Switch**  
It is for reset the system to reboot your computer instead of turning OFF the power switch. It is a better way to reboot your system for a longer life of the system's power supply.
- **Console Port**  
This is a Cisco RJ-type connector console port for command line interface and diagnostic support by P.O.S.T (Power On Self Test).
- **USB2.0 Ports**  
Two USB 2.0 ports supported.
- **LAN bypass LED(BP1/BP2)**  
While running the LAN By-Pass function, the LED always lights up.  
(Default one pair only, two pairs for optional)

- **Transfer Rate for LAN port**

The double-color LED light indicates 10/100/1000Mbps transfer rate.

LED Light Color	Transfer Rate
Dark	10Mbps
Green	100Mbps
Orange	1000Mbps

- If the LED is dark and Active/Link LED is lighting on flashing, the transfer rate should be 10Mbps.
- When the green-color LED light is radiating, the transfer rate should be 100Mbps.
- When the orange-color LED light is radiating, the transfer rate should be 1000Mbps.
- When this LED and Link/Active LED both are dark, no networking devices are attached.

- **Active/Link LED for LAN Port**

- The orange LED is on when the LAN port connection is working.
- The LED flashes when transmitting or receiving any signals to or from the appliance.
- The LED is dark when the appliance is off.

**Note:** *Optional LAN module LED definition in Appendix C.*

## 1.5.2 Rear Panel for NA363R



- **Power Supply**  
System power use power cord to connect the power supply to AC Inlet with power switch.
- **System Fans(smart fan)**  
These are fans for cooling down system temperature.

**This page is intentionally left blank.**

## CHAPTER 2

# HARDWARE DESCRIPTION

The **NA363R Series** are convenient for your various hardware configurations. The chapter 2 will help you get familiar with the hardware.

### 2.1 Checklist

The package bundled with your **NA363R** should contain the following items:

The **NA363R** network appliance hardware platform

- power cord x 1
- Mounting screws for disk drive
- cable kits (1 x SATA cable, 1 x SATA power cable )
- Plastic stand for stack-up x 4
- Rack mount ear kit



**NOTE: Please use VGA module for graphic mode OS installation.**

If you cannot find this package or any items are missing, please contact AXIOMTEK distributors immediately. If you order any optional components, the package might contain those additional hardware or documents accordingly.

### 2.2 Memory Module (UDIMM/RDIMM) and HDD

The main board supports four DDR4 UDIMM/RDIMM socket. Maximum memory capacity is up to 128GB ECC/Non-ECC unbuffered memory.

The following steps show you how to install the memory modules:

- 1 Push down each side of the DIMM socket.
- 2 Align the memory module with the socket that notches of memory module must match the socket keys for a correct installation.
- 3 Install the memory module into the socket and push it firmly down until it is fully seated. The socket latches are levered upwards and clipped on to the edges of the DIMM.
- 4 Install any remaining DIMM modules.

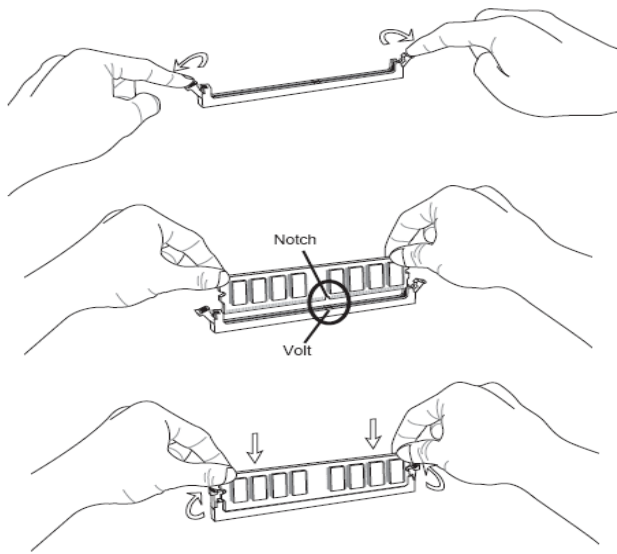

Connects SATA cable and SATA power cable from HDD to SATA connector (SATA1/SATA2) and SATA power connector (CN2/CN3) together then installs HDD by HDD rack and screws properly





## 2.3 Board Layout

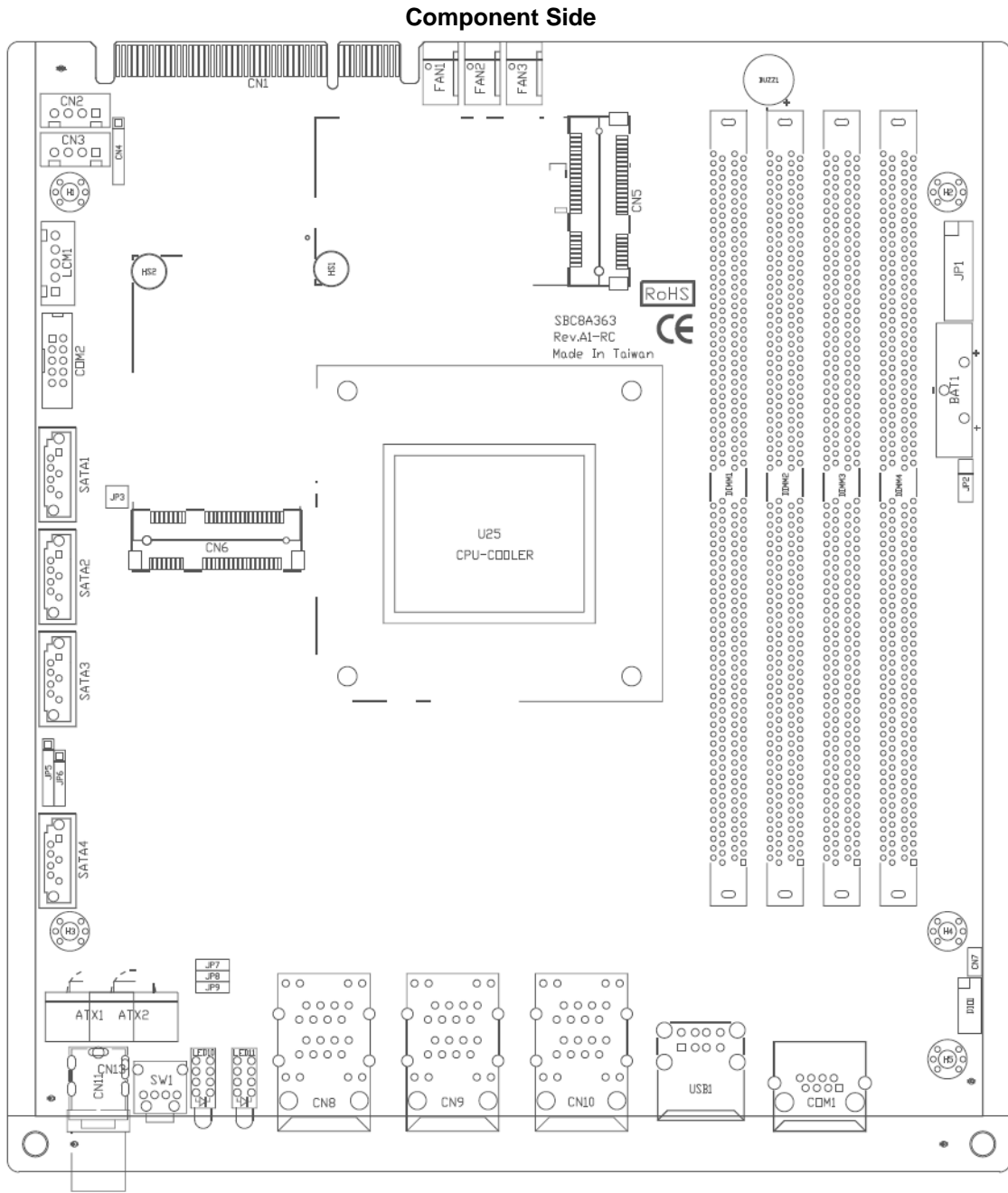

Bottom Side

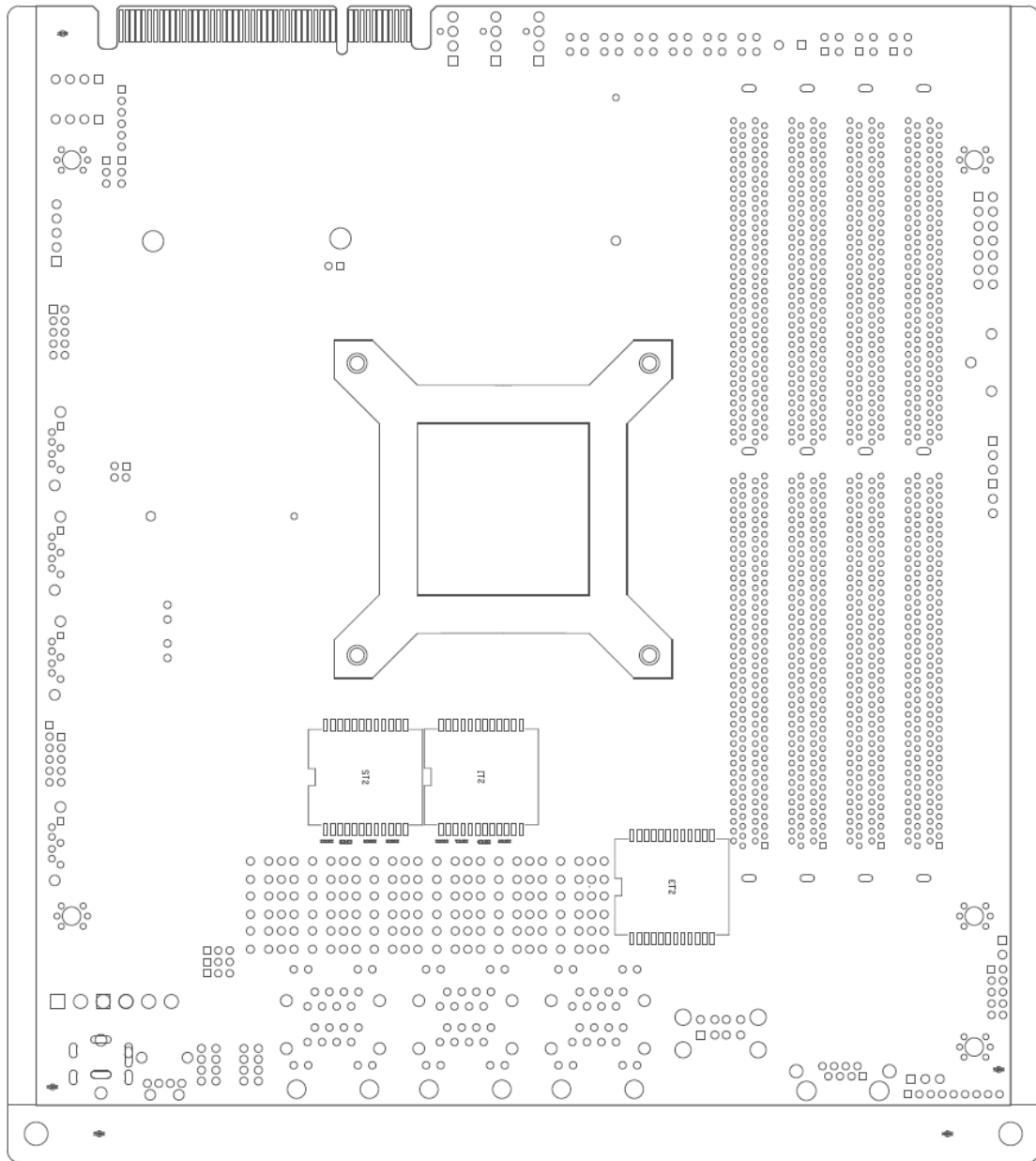



## 2.4 Jumper Settings

This section provides the information about jumpers and connectors of **NA363R Series**. Proper jumper settings configure the main board in this appliance to meet your application purpose. We are herewith listing a summary table of all jumpers and default settings for onboard devices, respectively.









Jumper	Definition	Jumper Settings
JP2	Clear CMOS Setting	1-2 : Normal (Default) 2-3 : Clear CMOS
JP4	Reserved	1-2 : Normal (Default)
JP6	TACT SW1 Low Button Function Selection	1-2 : Power button function 2-3 : Reset button function 4-5 : GPI function
JP7 JP8 JP9	LAN Bypass Trigger When Power On	(1-2)/(1-2)/(1-2) : Bypass as same as Power Off status (2-3)/(1-2)/(1-2) : Bypass Disable(Default) (2-3)/(2-3)/(1-2) : Bypass Enable
JP10	Reserved	1-2 : Normal (Default)

### 2.4.1 Clear CMOS Jumper (JP2)

You may need to use this jumper is to clear the CMOS memory if incorrect settings in the Setup Utility.

Description	Function	Jumper Setting
COMS Clear	Normal (Default)	<p><b>JP2</b></p> 
	Clear CMOS	<p><b>JP2</b></p> 



### 2.4.2 LAN Bypass Control Selection (JP7, JP8, JP9)

Description	Function	Jumper Setting
	Mother board/SEGN1 ~2 Bypass as same as Power Off status	 JP7 1 2 3  JP8 1 2 3  JP9 1 2 3
LAN Bypass Trigger when Power On	Mother board/SEGN1 ~2 Bypass Disable(Default)	 JP7 1 2 3  JP8 1 2 3  JP9 1 2 3
	Mother board/SEGN1 ~2 Bypass Enable	 JP7 1 2 3  JP8 1 2 3  JP9 1 2 3

 **NOTE:** When the system is turned on, you can select LAN bypass function by Jumper and Bios when power on state, when enter the OS; you can select LAN pass function at power on/ off state by software.

### 2.4.3 TACT SW1 Selection (JP6)

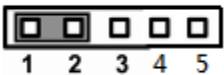
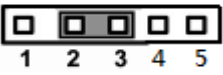
Use this jumper to select the TACT SW1 Function.

Description	Function	Jumper Setting
TACT SW1 Low Button Function Selection	Power button function	<p>JP6</p> 
	Reset button function (Default)	<p>JP6</p> 
	GPI-2 function	<p>JP6</p> 

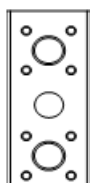

GPI-1 (Default Switch)

Lower Button



**NOTE:** If you need GPI sample codes please contact our FAE directly, and they are for reference purposes only.

## 2.5 Connectors

Connectors connect the board with other parts of the system. Loose or improper connection might cause problems. Make sure all connectors are properly and firmly connected. Here is a summary table shows you all connectors on the main board.

Connectors	Label
LCM Connector	LCM1
Digital Input / Output Connector	DIO1
Serial Port Connector	COM2
Smart FAN Connector(System FAN)	FAN1
Smart FAN Connector(CPU FAN)	FAN2
Smart FAN Connector(System FAN)	FAN3
Serial ATA Connector	SATA1~SATA4
SATA Power Connector	CN2
SATA Power Connector	CN3
Reserved	CN4
Mini Card Connector (PCIe interface)	CN5
Mini Card Connector (SATA interface)	CN6
Case Open Connector	CN7
DC Power Jack (for desktop optional)	CN11
Reserved	CN12
4P Wafer Power Input Connector	ATX2
Power Switch Connector(for desktop optional)	ATX1
COM1 (Console)	COM1
USB2.0 Connector	USB1
LAN1 and LAN2 Connector	CN8
LAN3 and LAN4 Connector	CN9
LAN5 and LAN6 Connector	CN10
DIMM Connector	DIMM1~DIMM4
LED (LED1~9 for desktop system(optional),LED10~11 for rack mount)	LED1~LED11
Front Panel Bezel Connector (JP1)	JP1
Reserved	JP3,JP5,UART1~2,

### 2.5.1 LCM Connector

Pin	Signal
1	+5V
2	RX
3	N.C
4	TX
5	GND

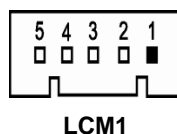

### 2.5.2 Digital Input / Output Connector (DIO1)

The board is equipped with an 8-channel (4 inputs and 4 outputs, default setting is “High”) digital I/O connector that meets requirements for a system customary automation control. The digital I/O can be configured to control cash drawers and sense warning signals from an Uninterrupted Power System (UPS), or perform store security control. You may use software programming to control these digital signals.

Pin	Signal
1	GND
2	GND
3	GPO3
4	GPI3
5	GPO2
6	GPI2
7	GPO1
8	GPI1
9	GPO0
10	GPI0

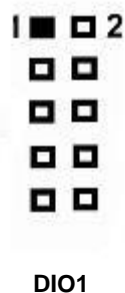

### 2.5.3 Serial Port2 Connector (COM2)

Pin	Signal
1	Data Carrier Detect (DCD)
2	Data Set Ready(DSR)
3	Receive Date(RXD)
4	Request to Send(RTS)
5	Transmit Data(TXD)
6	Clear to Send(CTS)
7	Data Terminal Ready(DTR)
8	Ring Indicator(RI)
9	GND
10	NC

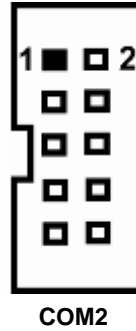

### 2.5.4 FAN Connector (FAN1, FAN2, FAN3)

Pin	Signal
1	GND
2	+12V level
3	Sensor
4	PWM

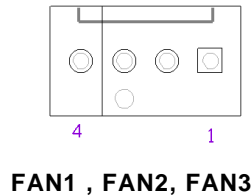

### 2.5.5 Serial ATA Connector: (SATA1, SATA2, SATA3, SATA4)

The SATA connector is for high-speed SATA interface port and it can be connected to hard disk device.

Pin	Signal	Pin	Signal
1	GND	2	TX+
3	TX-	4	GND
5	RX-	6	RX+
7	GND	—	—

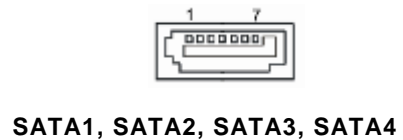



### 2.5.6 SATA Power Connector: (CN2, CN3)

The SATA power connector is for providing power to hard disk device.

Pin	Signal
1	+5V
2	GND
3	GND
4	+12V

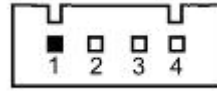

CN2, CN3

### 2.5.7 Mini Card Connector (CN5)

Default setting is PCIe/USB signal and reserves SATA signal for optional.

Pin	Signal	Pin	Signal
1	WAKE_N	2	P3V3_STBY
3	N/C	4	GND
5	N/C	6	P1V05_S
7	CLK_REQ_N	8	N/C
9	GND	10	N/C
11	DATA	12	N/C
13	CLK_N	14	N/C
15	CLK_P	16	N/C
17	GND	18	GND
19	N/C	20	RVD
21	N/C	22	RESET_N
23	RX_N	24	P3V3_STBY
25	RX_P	26	GND
27	GND	28	P1V05_S
29	GND	30	SMB_CLK
31	TX_N	32	SMB_DATA
33	TX_P	34	GND
35	GND	36	USB_N
37	GND	38	USB_P
39	P3V3_STBY	40	GND
41	P3V3_STBY	42	N/C
43	GND	44	N/C
45	N/C	46	N/C
47	N/C	48	P1V05_S
49	N/C	50	GND
51	N/C	52	P3V3_STBY

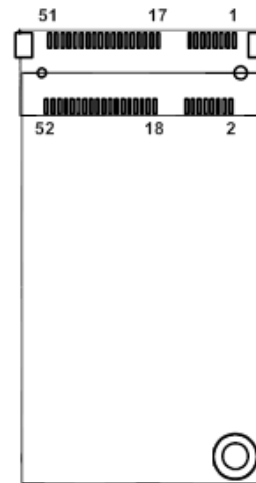

CN5

## 2.5.8 Mini Card Connector (CN6)

Default setting is SATA/USB signal and reserves PCIe signal for optional.

Pin	Signal	Pin	Signal
1	WAKE_N	2	P3V3_STBY
3	N/C	4	GND
5	N/C	6	P1V05_S
7	CLK_REQ_N	8	N/C
9	GND	10	N/C
11	DATA	12	N/C
13	CLK_N	14	N/C
15	CLK_P	16	N/C
17	GND	18	GND
19	N/C	20	RVD
21	N/C	22	RESET_N
23	RX_P	24	P3V3_STBY
25	RX_N	26	GND
27	GND	28	P1V05_S
29	GND	30	SMB_CLK
31	TX_N	32	SMB_DATA
33	TX_P	34	GND
35	GND	36	USB_N
37	GND	38	USB_P
39	P3V3_STBY	40	GND
41	P3V3_STBY	42	N/C
43	GND	44	N/C
45	N/C	46	N/C
47	N/C	48	P1V05_S
49	N/C	50	GND
51	N/C	52	P3V3_STBY

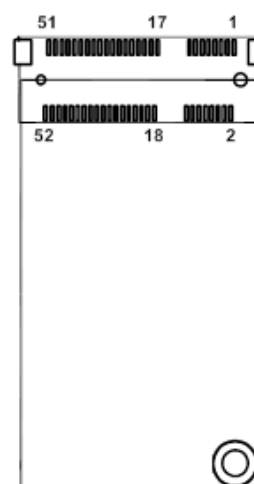

CN6

### 2.5.9 Case Open Connector (CN7)

Pin	Signal
1	CASEOPEN_N
2	GND



CN7

### 2.5.10 DC-In Power Jack (CN11)

Pin	Signal
1	+12V
2	GND

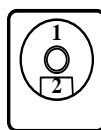

CN11

### 2.5.11 4P Wafer Power Input Connector (ATX2)

Pin	Signal
1	+12V
2	+12V
3	GND
4	GND

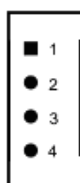

ATX2

### 2.5.12 Power Switch Connector desktop system (ATX1)

Pin	Signal
1	+12V
2	+12V
3	DC_INPUT
4	DC_INPUT

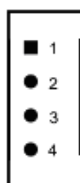

ATX1

### 2.5.13 Serial Port for Console (COM1)

The COM1 Port connector is a RJ-type connector

Pin	Signal
1	Request to Send (RTS)
2	Data Terminal Ready (DTR)
3	Transmit Data (TXD)
4	Ground (GND)
5	Ground (GND)
6	Receive Data (RXD)
7	Data Set Ready (DSR)
8	Clear to Send (CTS)

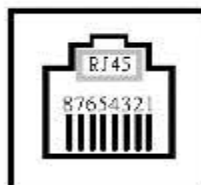

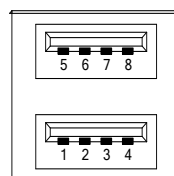

### 2.5.14 USB port Connector (USB1)

Pin	Signal
1	USB VCC (+5V level standby power)
2	USB #0_D-
3	USB #0_D+
4	Ground (GND)
5	USB VCC (+5V level standby power)
6	USB #1_D-
7	USB #1_D+
8	Ground (GND)



## 2.5.15 LED1~11

LED1~11(1~9 for Desktop system, 10~11 for rack mount system)

LED	Signal
LED1	Up : Power LED (Green) Down : HDD LED (Green)
LED2	Up : GPO(Programmable LED) Down : GPO (Programmable LED)
LED3	Up : Lan Bypass 1 LED (Green) Down : Lan Bypass 2 LED (Green)
LED4	For Lan1 Up : LINK (Green : LINK100 ; Amber : LINK1000) Down : Active (Orange)
LED5	For Lan2 Up : LINK (Green : LINK100 ; Amber : LINK1000) Down : Active (Orange)
LED6	For Lan3 Up : LINK (Green : LINK100 ; Amber : LINK1000) Down : Active (Orange)
LED7	For Lan4 Up : LINK (Green : LINK100 ; Amber : LINK1000) Down : Active (Orange)
LED8	For Lan5 Up : LINK (Green : LINK100 ; Amber : LINK1000) Down : Active (Orange)
LED9	For Lan6 Up : LINK (Green : LINK100 ; Amber : LINK1000) Down : Active (Orange)
LED10	Lan Bypass LED Lan Bypass LED POWER LED HDD LED 
LED11	GPO LED GPO LED GPO LED GPO LED 

### 2.5.16 Front Panel Bezel Connector (JP1)

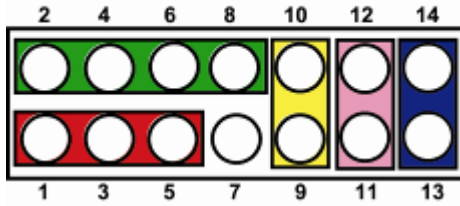

#### Power LED :

This 3-pin connector (Pin 1, 3, 5) connects a LED indicator to the system power switch on the case. Pin 1 is assigned as +, and Pin 3, Pin 5 as -. The Power LED lights up when the system is powered ON.

#### External Speaker and Internal Buzzer Connector :

This 4-pin connector (Pin 2, 4, 6, 8) can be connected to the case-mounted speaker unit or internal buzzer. While connecting the CPU card to an internal buzzer, please short pins 2-4; while connecting to an external speaker, you need to set pins 2-4 to Open and connect the speaker cable to pin 8 (+) and pin 2 (-).

#### System Reset Switch :

This 2-pin connector (Pin 11, 12) can be connected to the case-mounted reset switch that reboots your computer instead of turning OFF the power switch. It is a better way to reboot your system for a longer life of the system's power supply.

#### HDD Activity LED :

This connection is linked to hard drive activity LED on the control panel. LED flashes when HDD is being accessed. The 2-pin connector (Pin 13, 14) connects the hard disk drive to the front panel HDD LED, Pin 13 assigned as -, and Pin 14 as +.

## CHAPTER 3

# AMI BIOS SETUP UTILITY

This chapter provides users with detailed description how to set up basic system configuration through the AMIBIOS8 BIOS setup utility.

### 3.1 Starting

To enter the setup screens, follow the steps below:

1. Turn on the computer and press the <Del> key immediately.
2. After you press the <Delete> key, the main BIOS setup menu displays. You can access the other setup screens from the main BIOS setup menu, such as the Chipset and Power menus.



**NOTE:** Please use VGA module for graphic mode OS installation.

### 3.2 Navigation Keys

The BIOS setup/utility uses a key-based navigation system called hot keys. Most of the BIOS setup utility hot keys can be used at any time during the setup navigation process.

These keys include <F1>, <F10>, <Enter>, <ESC>, <Arrow> keys, and so on.



**NOTE:** Some of navigation keys differ from one screen to another.

← Left/Right	The Left and Right <Arrow> keys allow you to select a setup screen.
↑↓ Up/Down	The Up and Down <Arrow> keys allow you to select a setup screen or sub-screen.
+– Plus/Minus	The Plus and Minus <Arrow> keys allow you to change the field value of a particular setup item.
Tab	The <Tab> key allows you to select setup fields.
F1	The <F1> key allows you to display the General Help screen.
F10	The <F10> key allows you to save any changes you have made and exit Setup. Press the <F10> key to save your changes.
Esc	The <Esc> key allows you to discard any changes you have made and exit the Setup. Press the <Esc> key to exit the setup without saving your changes.
Enter	The <Enter> key allows you to display or change the setup option listed for a particular setup item. The <Enter> key can also allow you to display the setup sub- screens.

### 3.3 Main Menu

When you first enter the Setup Utility, you will enter the Main setup screen. You can always return to the Main setup screen by selecting the Main tab. There are two Main Setup options. They are described in this section. The Main BIOS Setup screen is shown below.

#### System Time/Date

Use this option to change the system time and date. Highlight *System Time* or *System Date* using the <Arrow> keys. Enter new values through the keyboard. Press the <Tab> key or the <Arrow> keys to move between fields. The date must be entered in MM/DD/YY format. The time is entered in HH:MM:SS format.

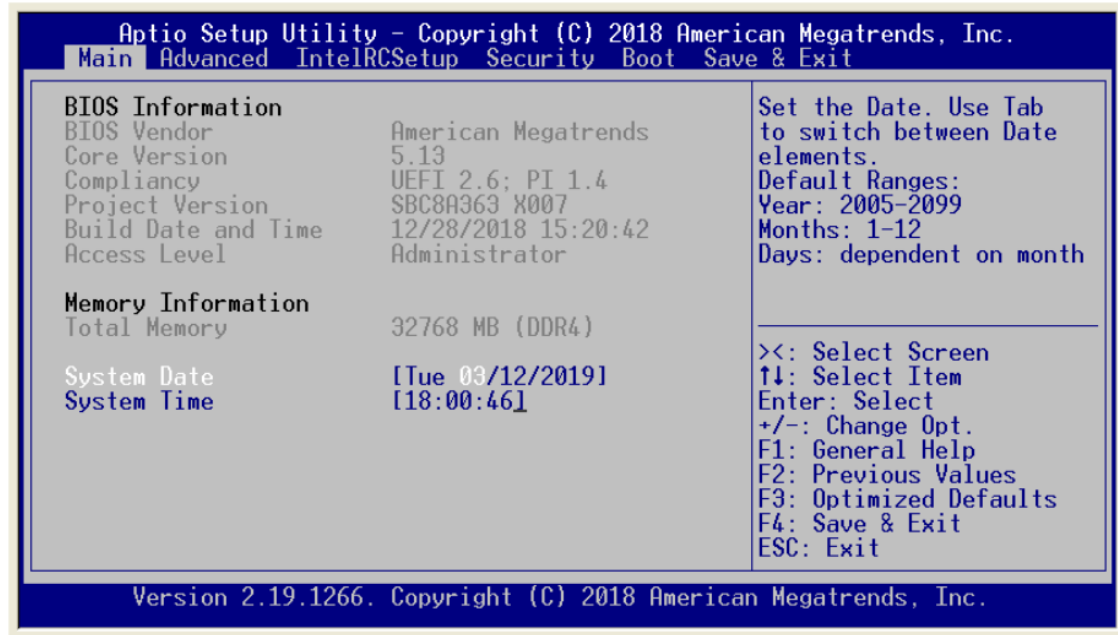



### 3.4 Advanced Menu

The Advanced menu allows users to set configuration of the CPU and other system devices. You can select any of the items in the left frame of the screen to go to the sub menus:

- ▶ **Trusted Computing**
- ▶ **NCT6102D Super IO Configuration**
- ▶ **Hardware Monitor**
- ▶ **Serial Port Console Redirection**
- ▶ **CSM Configuration**
- ▶ **USB Configuration**

For items marked with "▶", please press <Enter> for more options.

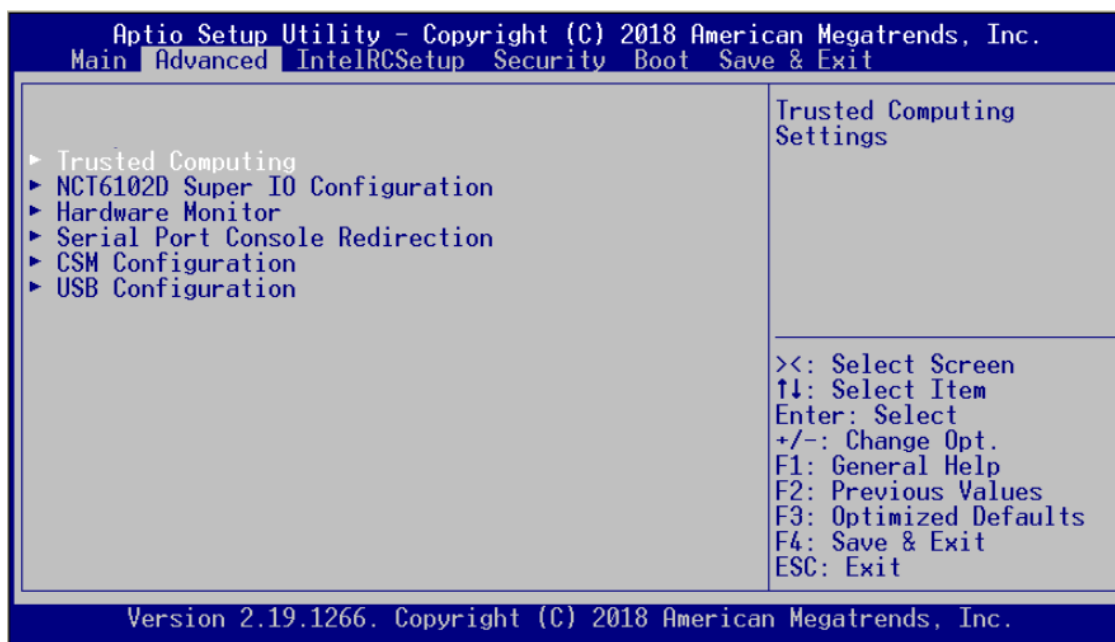

## Trusted Computing

This screen provides the function for specifying the TPM and Security device setting.

### Security device setup

Use this item to enable or disable BIOS support for security device. OS will not show Security Device.

### TPM State

Use this item to enable or disable control TPM function.

 **NOTE:** TPM function is available with sku of TPM on board.

 **NOTE:** Your computer will reboot during restart in order to change state of security device.

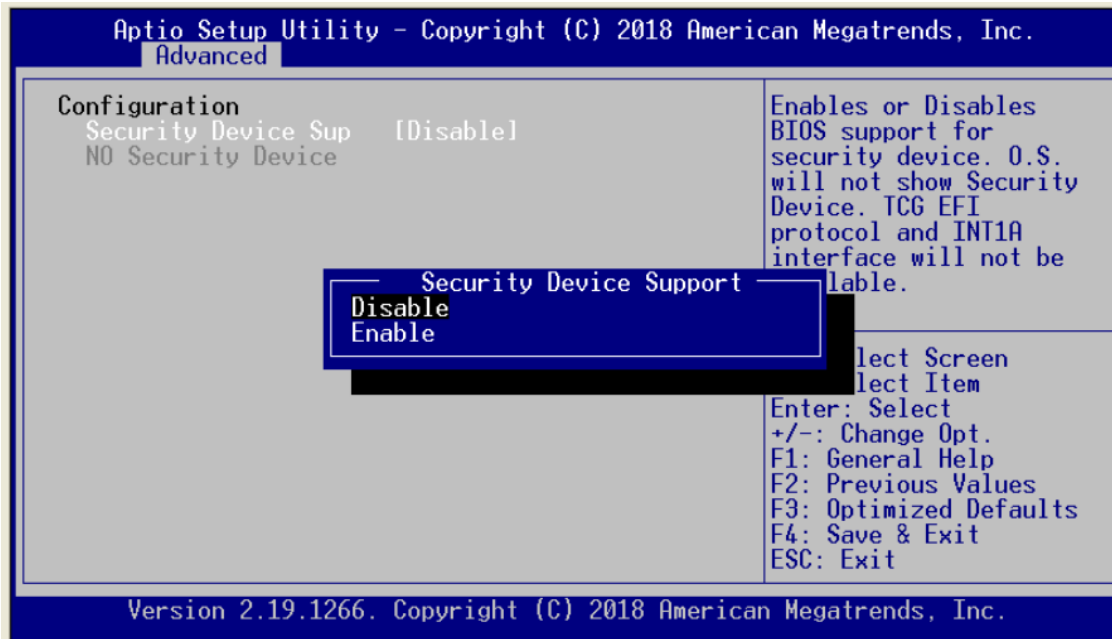

## Pending Operation

Schedule an operation for Security device.

 **NOTE:** Your computer will reboot during restart in order to change state of security device.

 **NOTE:** Clearing TPM Secured Data: When TPM State is set to [Enabled], Pending TPM Operation will appear. Set this item to [TPM Clear] to clear all data secured by TPM or [None] to discard the selection.

Aptio Setup Utility - Copyright (C) 2018 American Megatrends, Inc.  
**Advanced**

<b>Configuration</b> Security Device Sup [Enable] TPM State [Disabled] Pending operation [None]	Enable/Disable Security Device. NOTE: Your Computer will reboot during restart in order to change State of the Device.
<b>Current Status Information</b> TPM Enabled Status: Di TPM Active Status: De TPM Owner Status: Ow	TPM State Disabled Enabled

>>: Select Screen  
 ↑↓: Select Item  
 Enter: Select  
 +/-: Change Opt.  
 F1: General Help  
 F2: Previous Values  
 F3: Optimized Defaults  
 F4: Save & Exit  
 ESC: Exit

Version 2.19.1266. Copyright (C) 2018 American Megatrends, Inc.

Aptio Setup Utility - Copyright (C) 2018 American Megatrends, Inc.  
**Advanced**

<b>Configuration</b> Security Device Sup [Enable] TPM State [Enabled] Pending operation [None]	Schedule an Operation for the Security Device. NOTE: Your Computer will reboot during restart in order to change State of Security Device.
<b>Current Status Information</b> TPM Enabled Status: TPM Active Status: TPM Owner Status:	Pending operation None TPM Clear

: Select Screen  
 : Select Item  
 Enter: Select  
 +/-: Change Opt.  
 F1: General Help  
 F2: Previous Values  
 F3: Optimized Defaults  
 F4: Save & Exit  
 ESC: Exit

Version 2.19.1266. Copyright (C) 2018 American Megatrends, Inc.

### NCT 6102D Super IO Configuration

You can use this screen to select options for the Super IO Configuration, and change the value of the selected option. A description of the selected item appears on the right side of the screen.

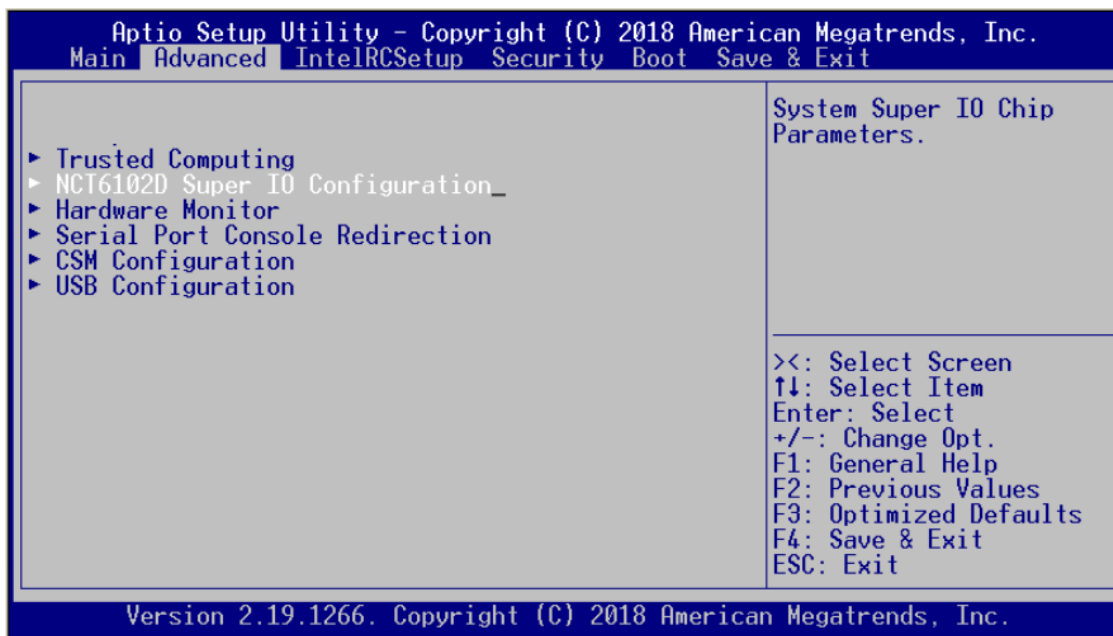

### Serial Port1 Address

This option specifies the base I/O port address and Default setting is 3F8h.  
Here are the options for your selection, Disabled.

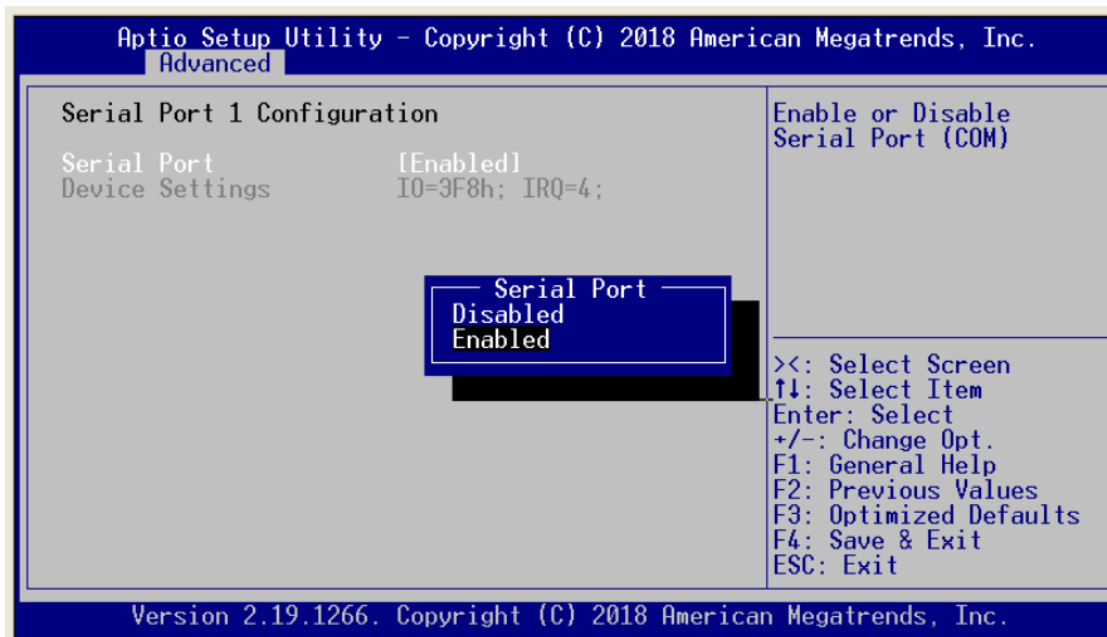
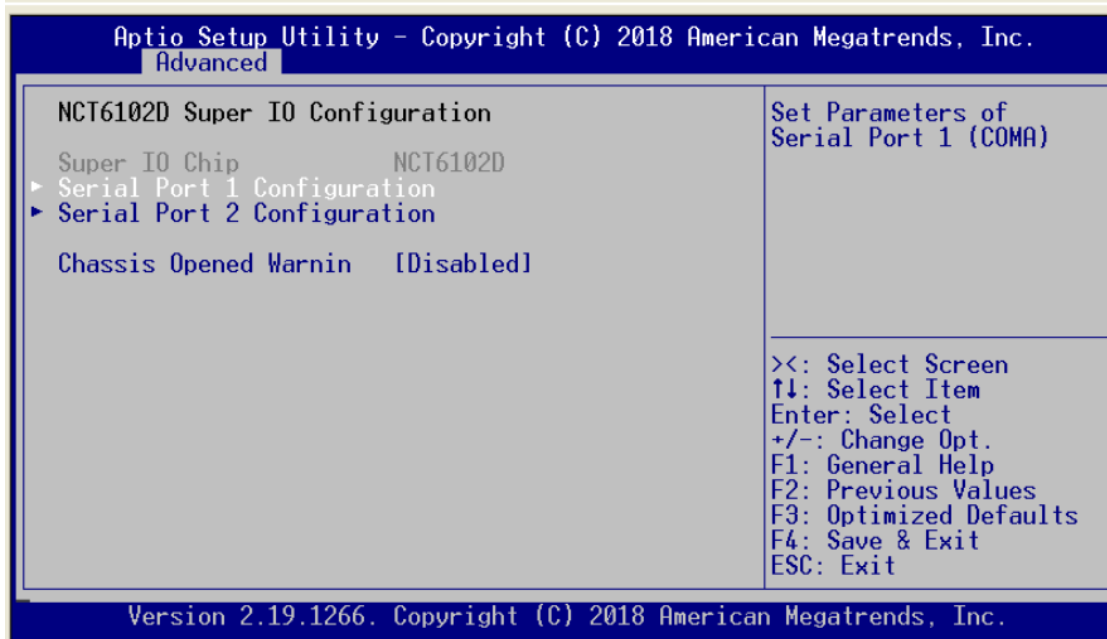

### Serial Port2 Address

This option specifies the base I/O port address and Default setting is 2F8h.  
Here are the options for your selection, Disabled.

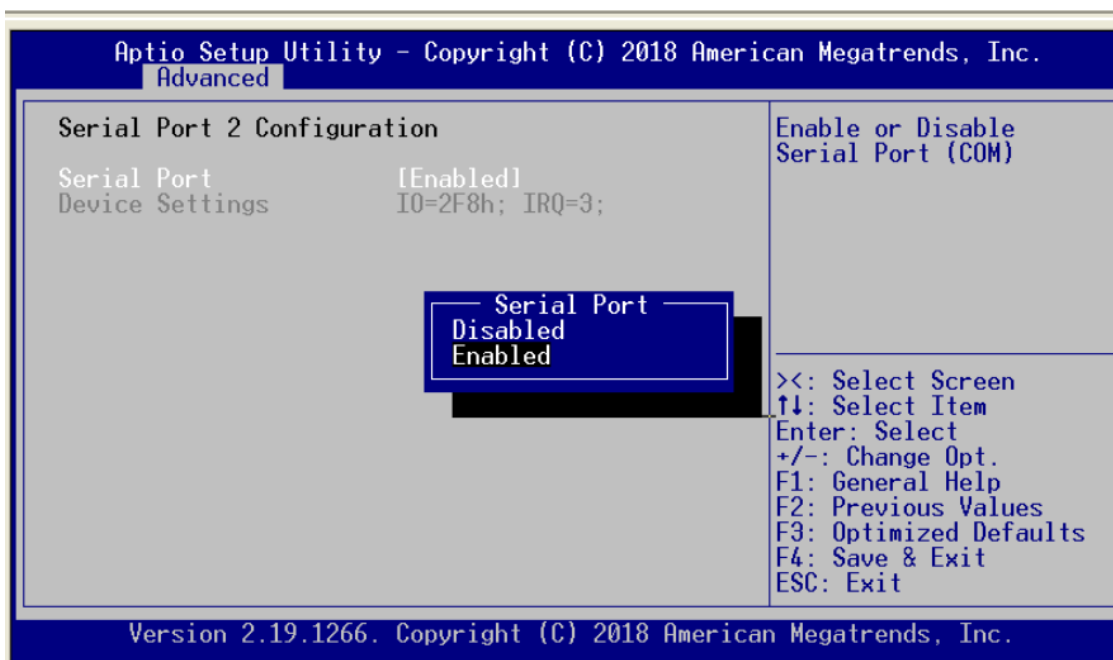
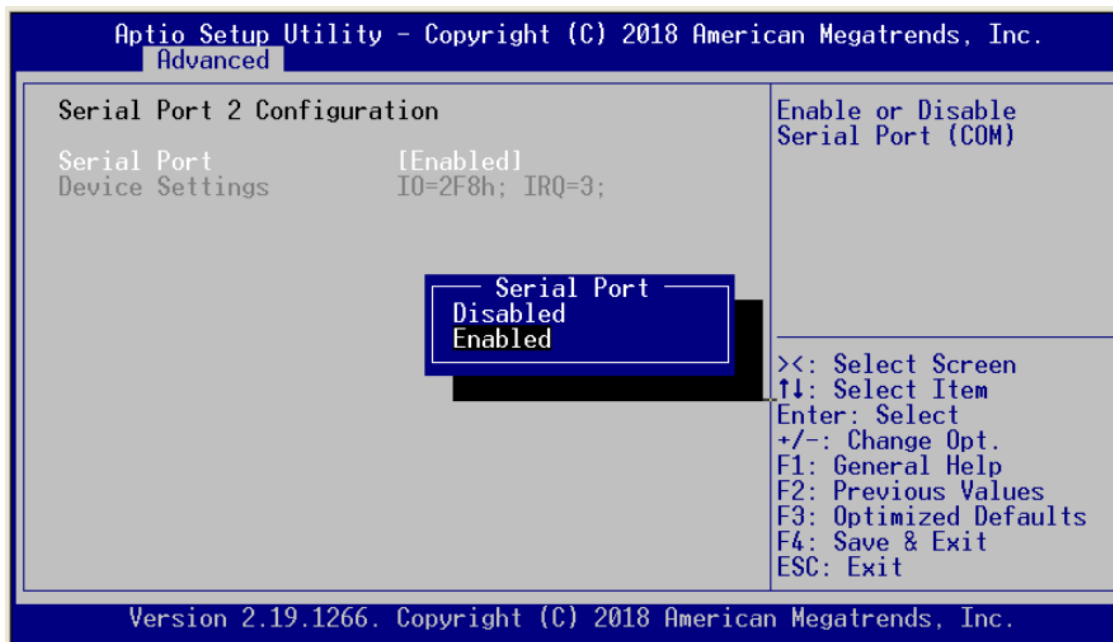

### Chassis Opened Warning

Select to enable or disable chassis intrusion detection. Chassis intrusion detection is a utility that can tell whether someone has opened the case and trigger the buzzer on board.

Remark: Pin header design has reserved for customized chassis.

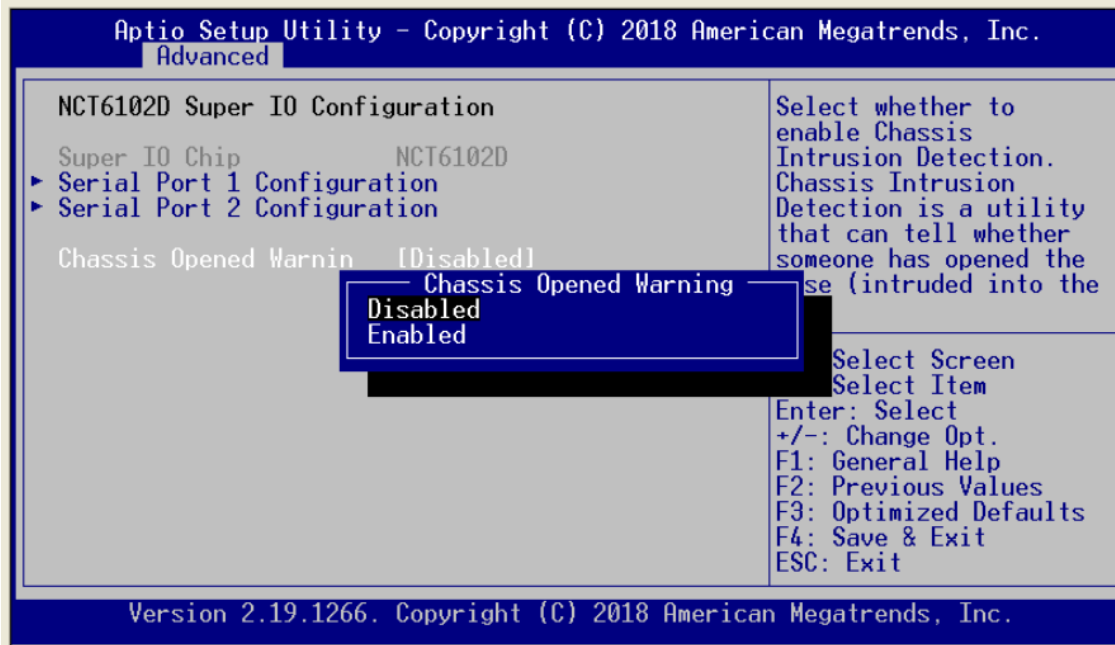

## HW Monitor

This screen shows the Hardware Health Configuration, and a description of the selected item appears on the right side of the screen.

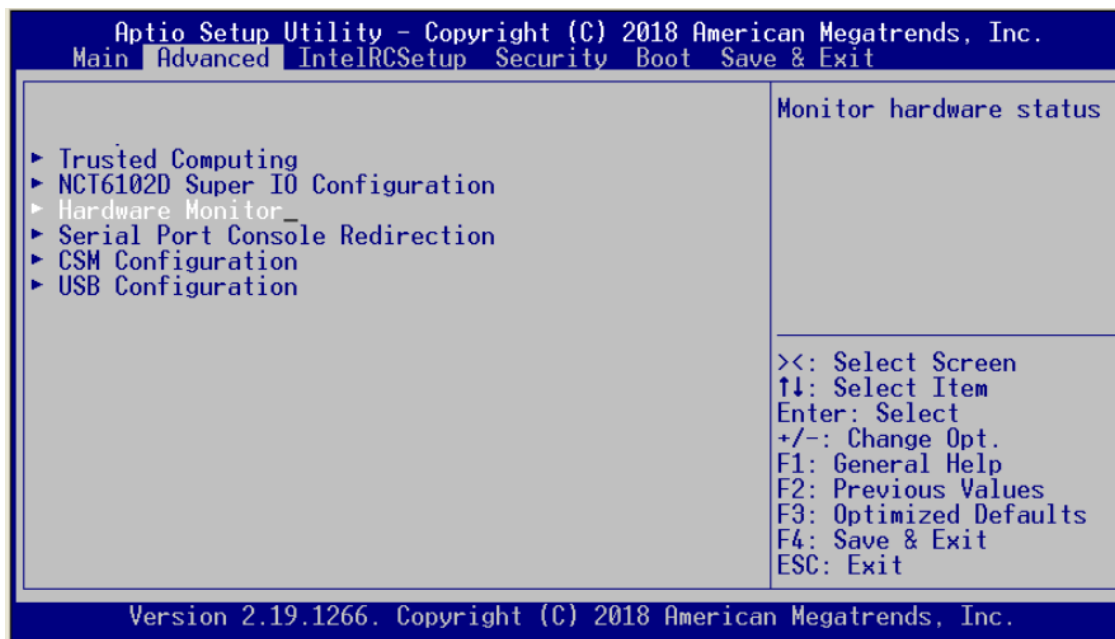



**System Temperature**

Show you the current system temperature.

**CPU Temperature**

These read-only fields show the functions of the hardware thermal sensor by CPU thermal diode that monitors the chip blocks to ensure a stable system.

**Fan Speed**

NA363R equips 2pcs fan and it shows cooling fan speed in RPM. If the fan Speed is N/A, it means no fan available.

**Vcore 5V / 3.3V**

Show you the voltage of 5V/ 3.3V and etc.

```
Aptio Setup Utility - Copyright (C) 2018 American Megatrends, Inc.
  Advanced
Pc Health Status
System temperature      : +34 C
CPU Temperature        : +38 C
FAN1 Speed             : 4821 RPM
FAN2 Speed             : 2766 RPM
FAN3 Speed             : 4770 RPM
V CORE                 : +1.088 V
+12V                   : +12.000 V
+5V                    : +4.920 V
+3.3V                  : +3.328 V
><: Select Screen
↑↓: Select Item
Enter: Select
+/-: Change Opt.
F1: General Help
F2: Previous Values
F3: Optimized Defaults
F4: Save & Exit
ESC: Exit
Version 2.19.1266. Copyright (C) 2018 American Megatrends, Inc.
```

**Serial Port Console Redirection**

To use the external serial port as console, it is needed to enable serial port console redirection.

**Console Redirection**

Console Redirection Enable or Disable.

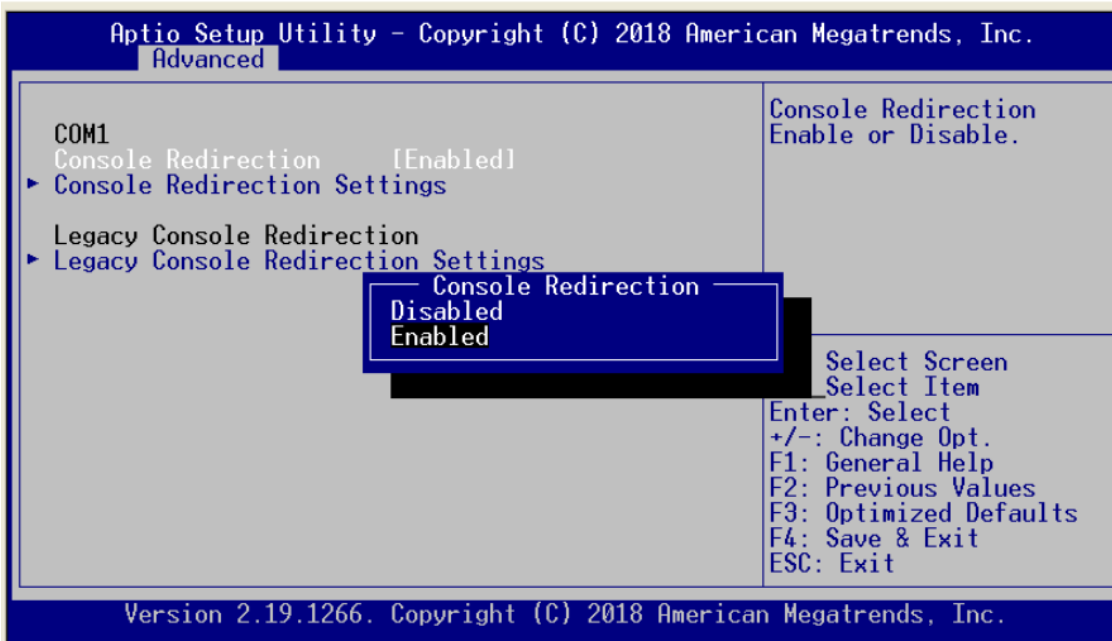
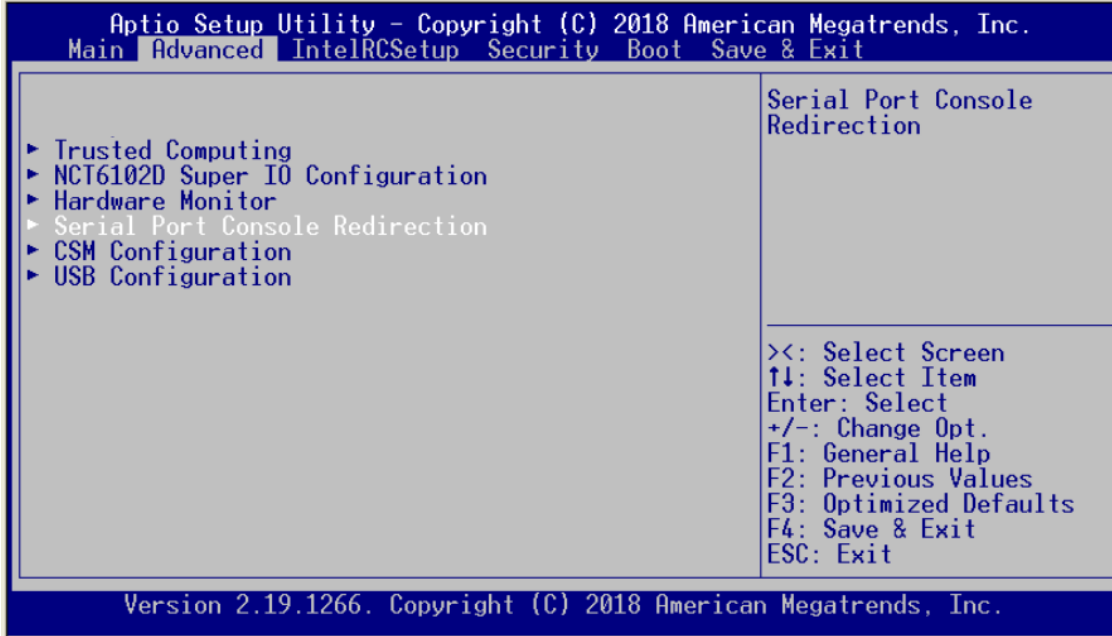

### Console Redirection Setting

This setting specifies how the host computer and the remote computer will exchange data.

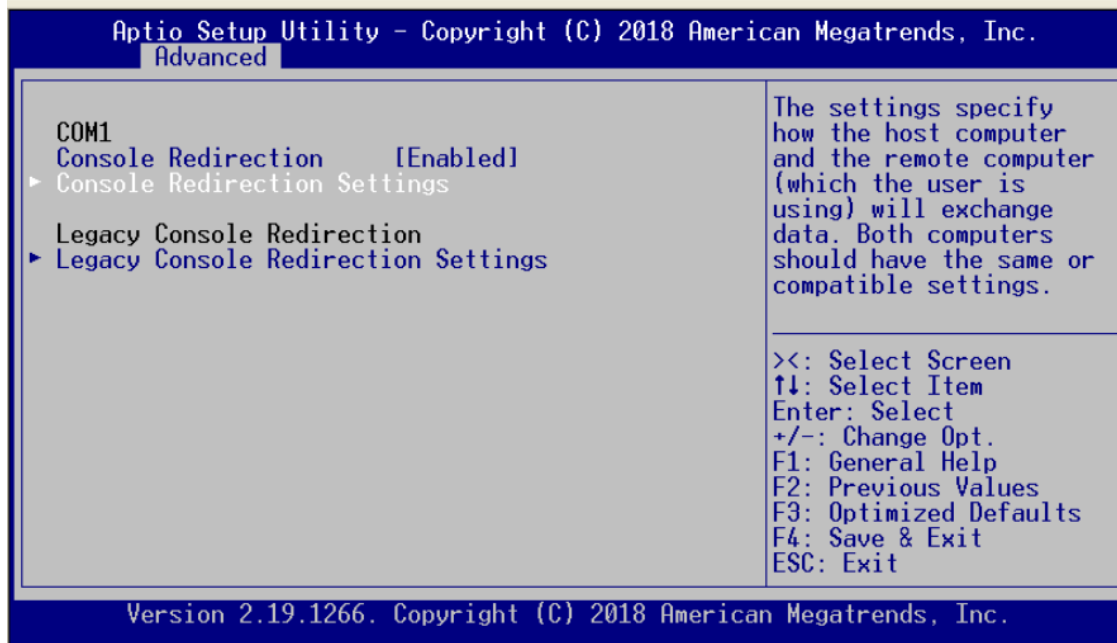

## Terminal Type

This item allows you to select the target terminal type. Configuration options: ANSI, VT100, VT100+ and VT-UTF8.

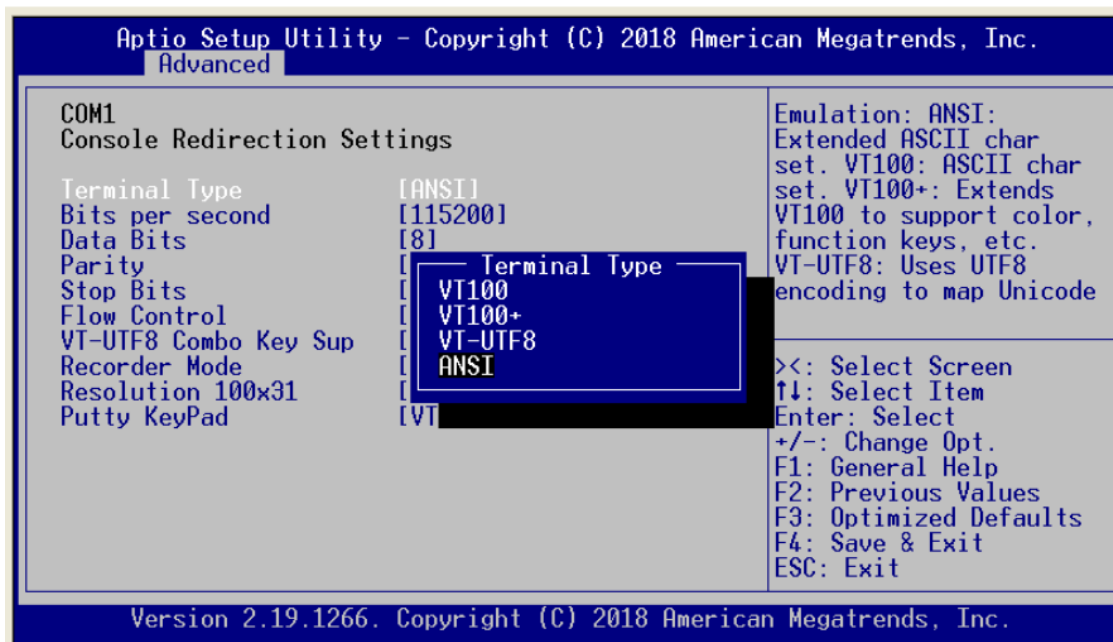

### Bits per second

This item allows you to setup the data transfer rate for the console port. The default value is 115200. Available options are "9600", "19200", "38400", "57600" and "115200".

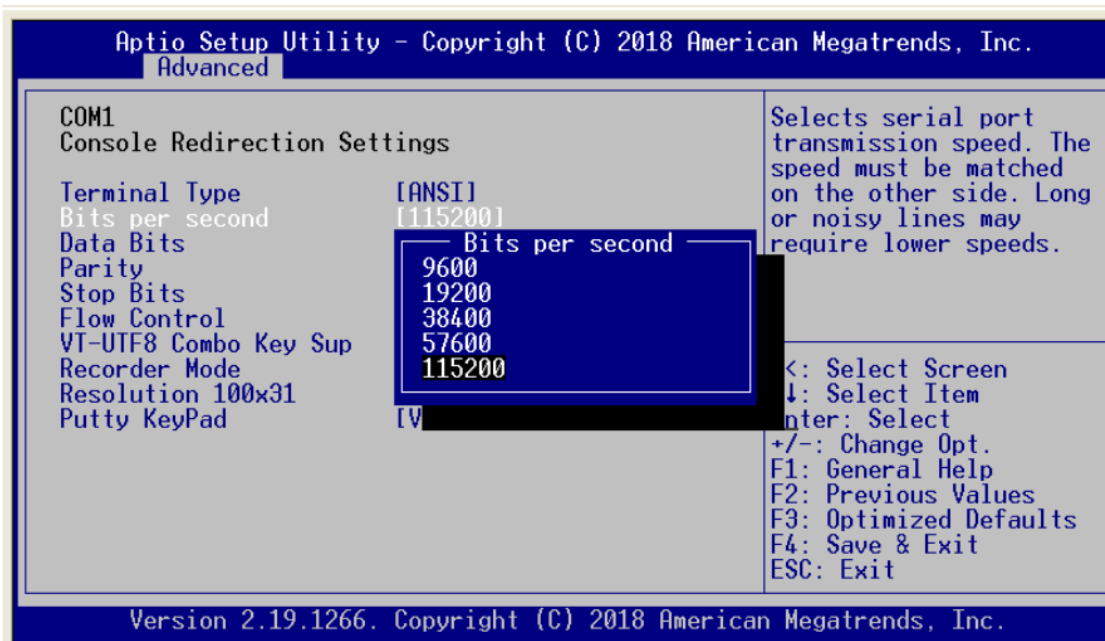

### Data Bits

This item allows you to select the data bits. The configuration options: 7 and 8.

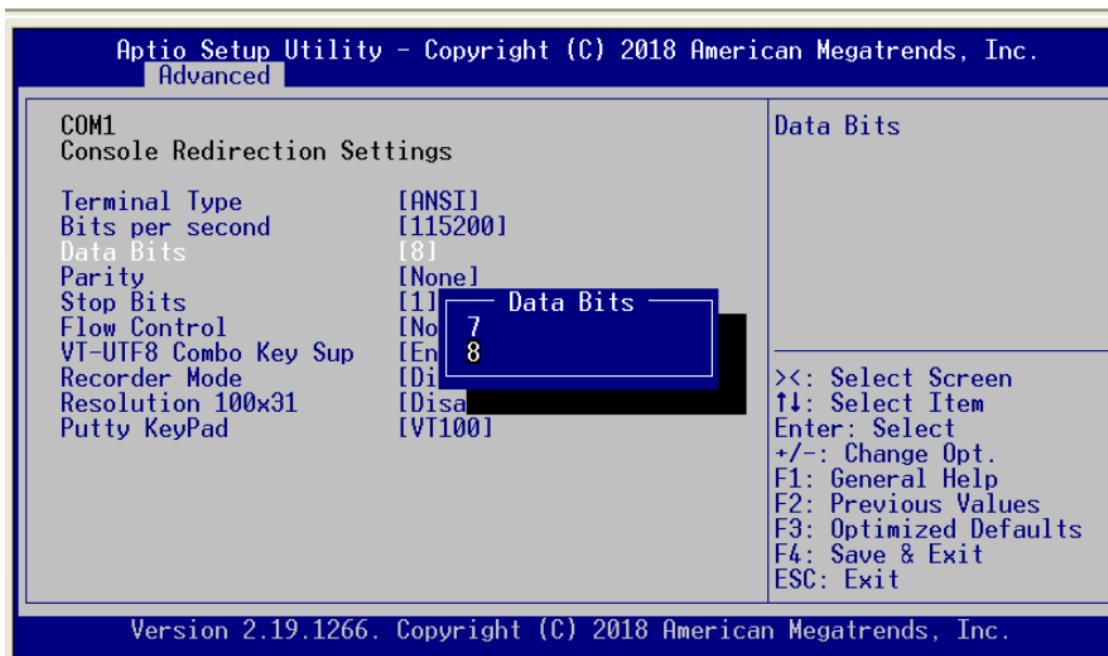

**Parity**

This item allows you to select flow control for console redirection. The configuration options: None, Even, Odd, Mark and Space.

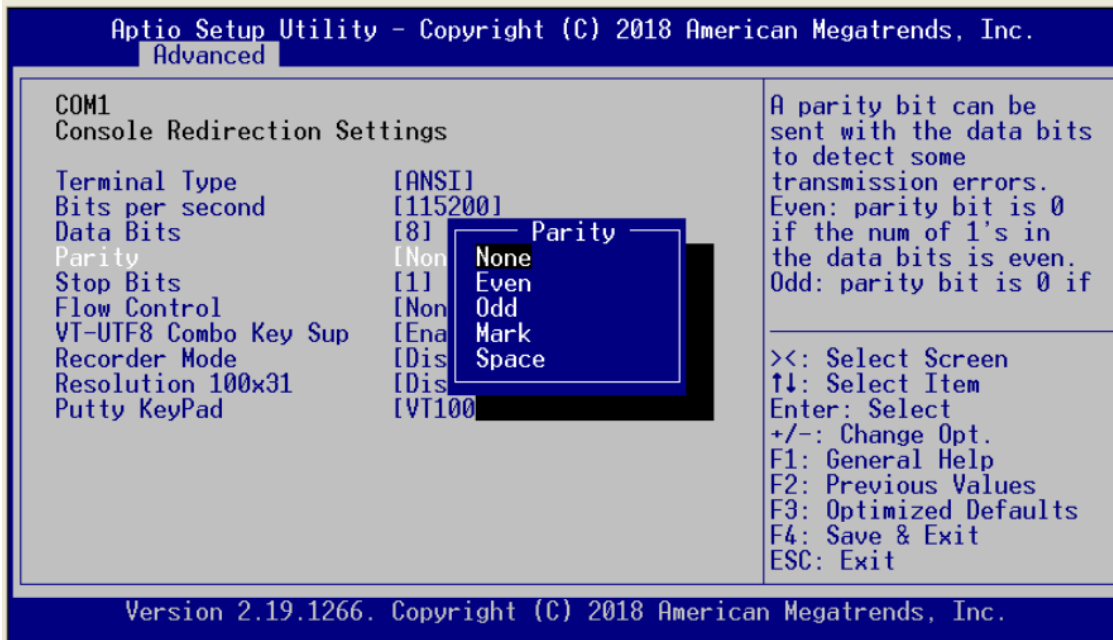

**Stop Bits**

This item allows you to select the data bits. The configuration options: 1 and 2.

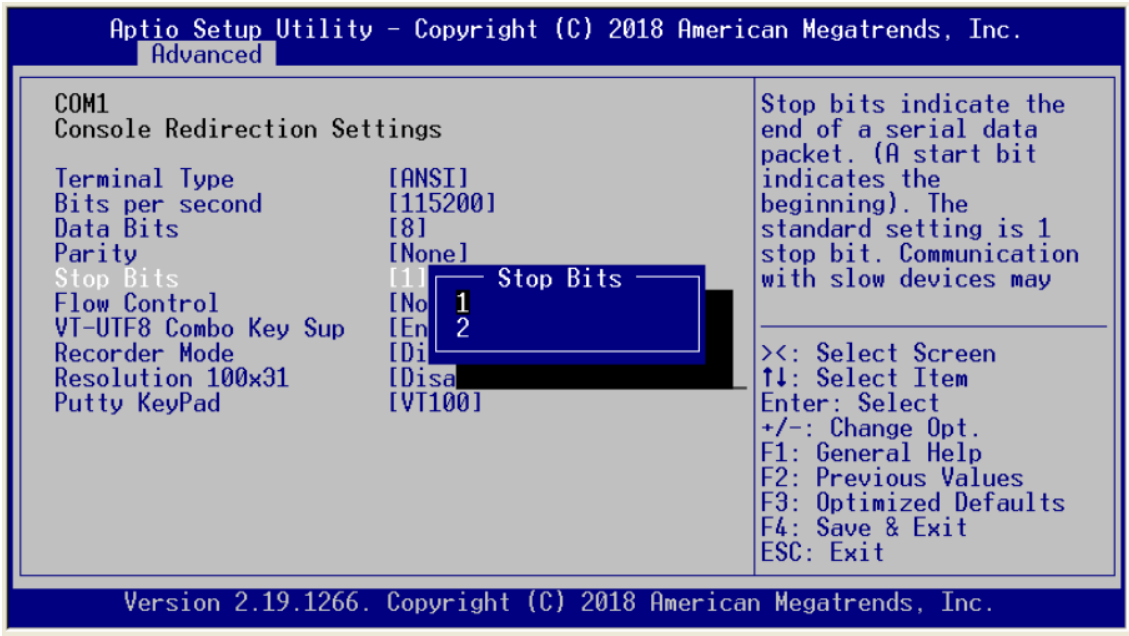

## Flow Control

This item allows you to select flow control for console redirection. The configuration options: None, Hardware and Software.

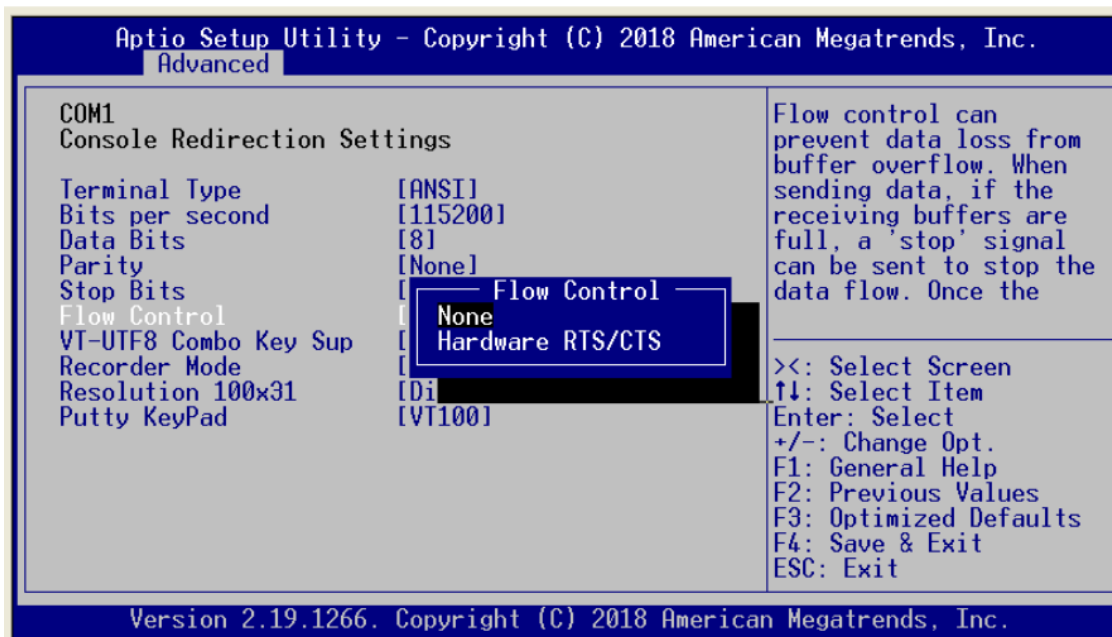

## VT-UTF8 Combo Key Support

Use this item to "Enabled" or "Disabled" VT-UTF8 combination key supports for ANSI / VT100 terminals.

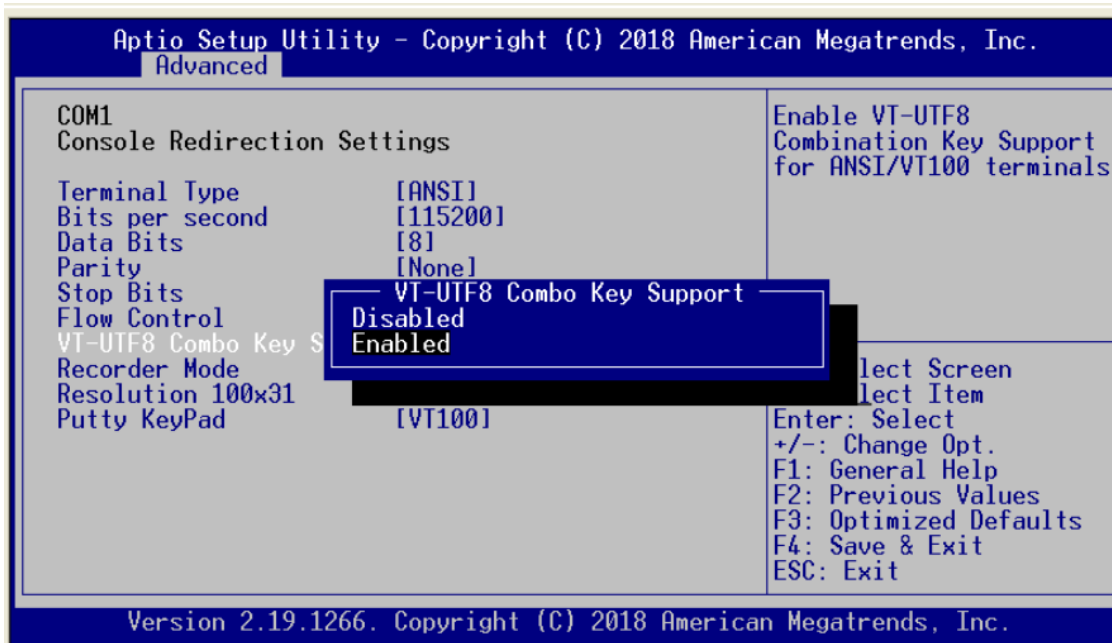

### Recorder Mode

This item allows you to select the recorder mode. The configuration options: Enabled and Disabled.

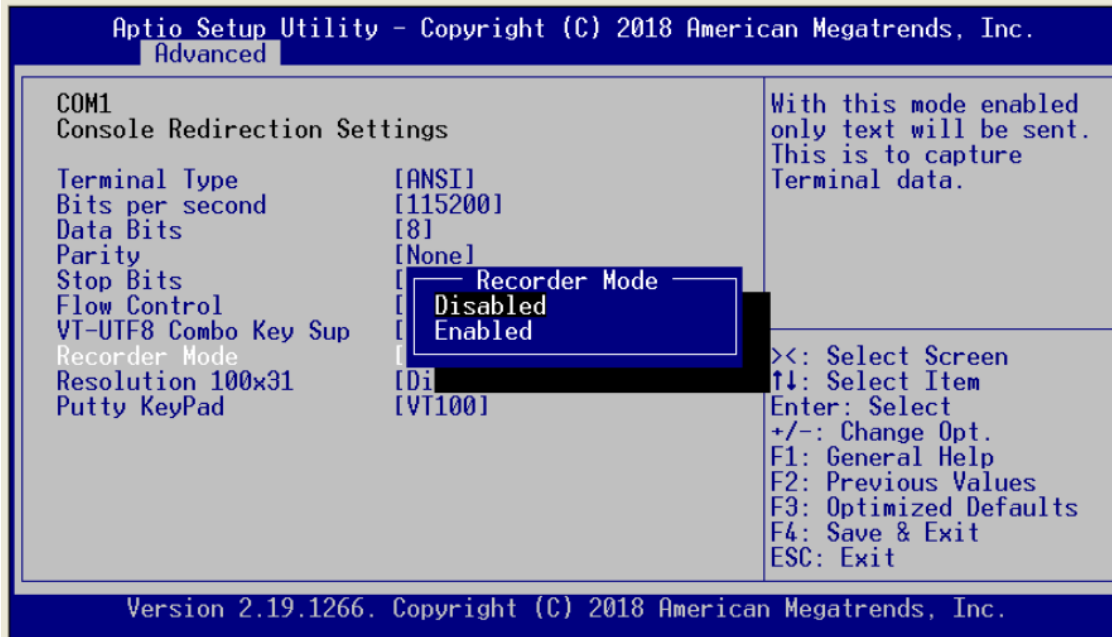

### Resolution

Enable or disable extended terminal resolution.

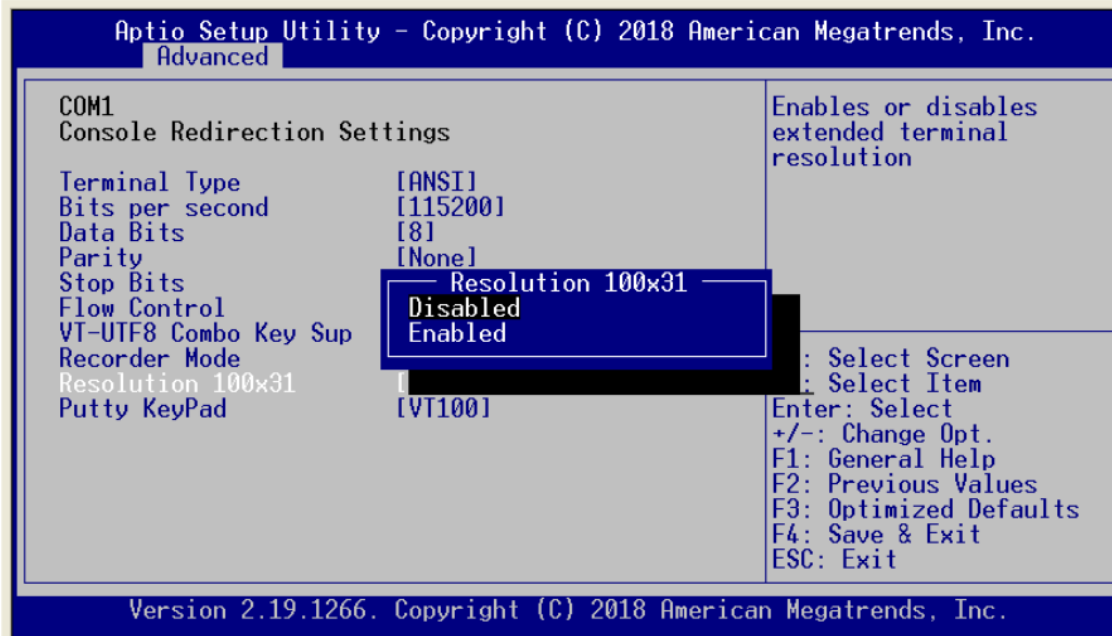



### Putty Keypad

This item allows you to select the putty keypad. The configuration options: VT100, LINUX, XTERMR6, SCO, ESCN and VT400.

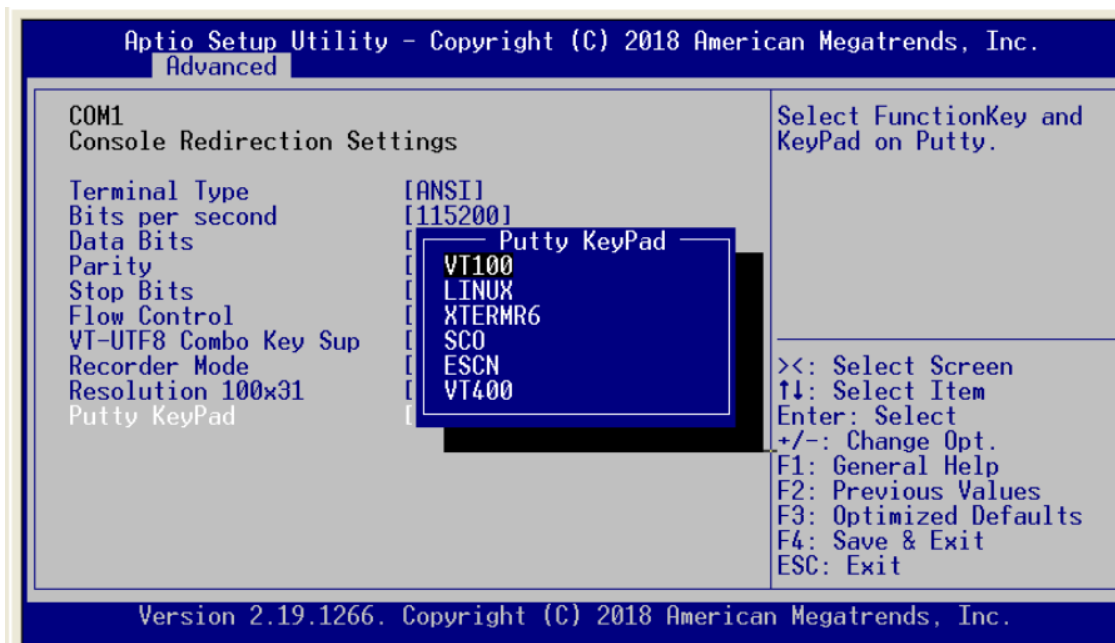

## Legacy Console Redirection Settings

This item allows you to configure the legacy console redirection.

### Redirection After BIOS POST

Use this item to enable or disable the function of Console Redirection, which allows you maintain a system from a remote location. The default setting is *Always*.

 **NOTE:** *POST, Power-on self –test is a process to check CPU, memory and mother board after system is powered on.*

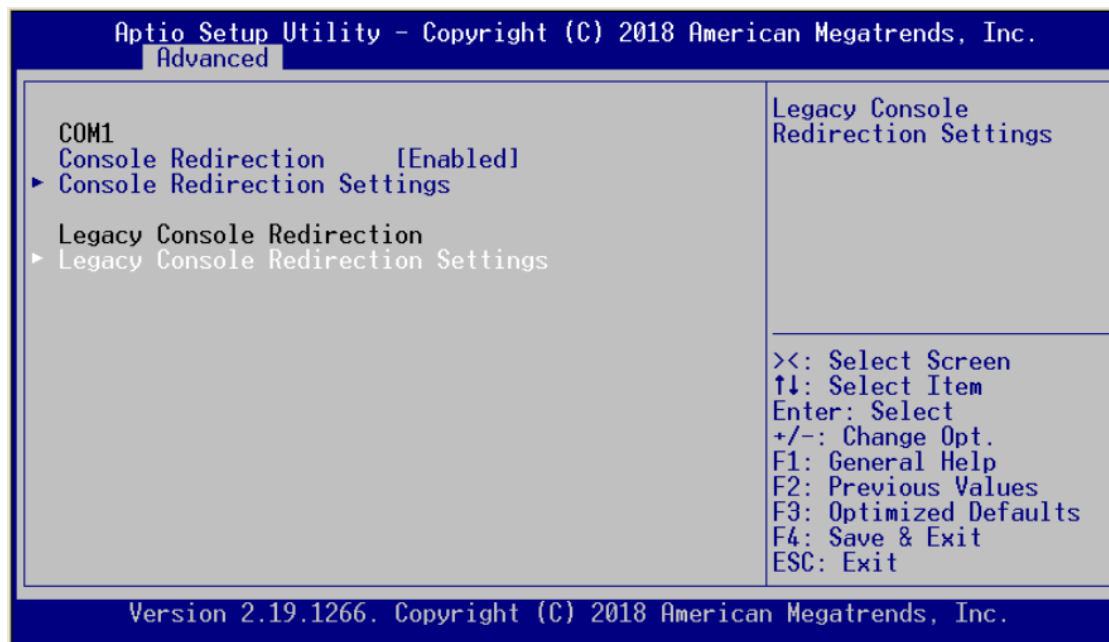

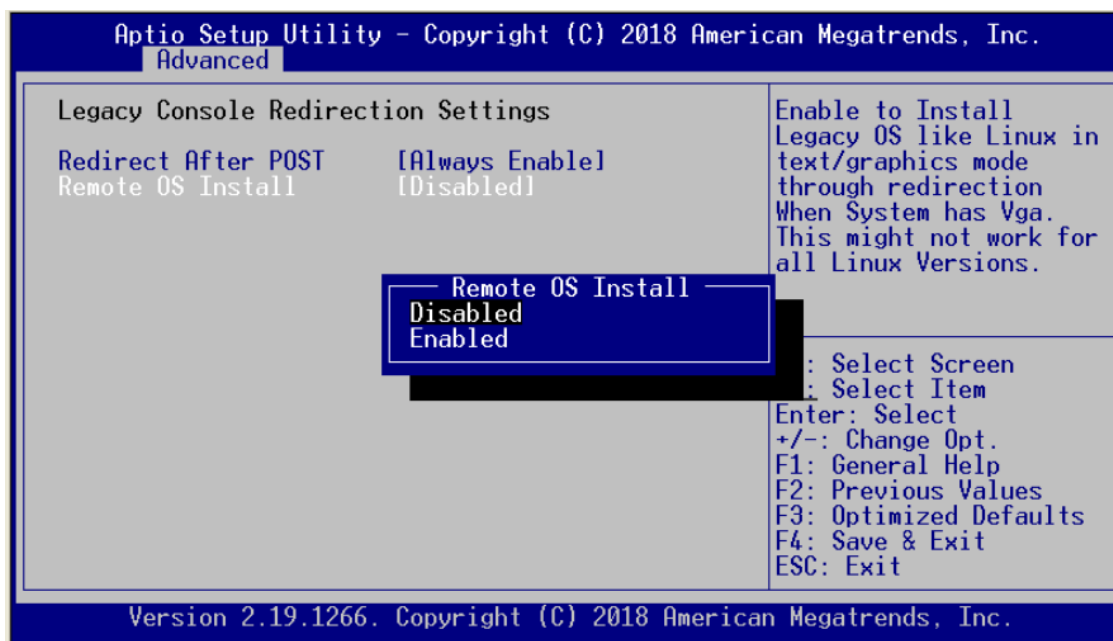

### Remote OS Install

This item allows you to select the install legacy OS through remote. The configuration options: "Enabled" or "Disabled".

**CSM Configuration (Compatibility Support Module)**

Use CSM configuration to enable/disable, Option ROM execution setting for LAN by pass function.

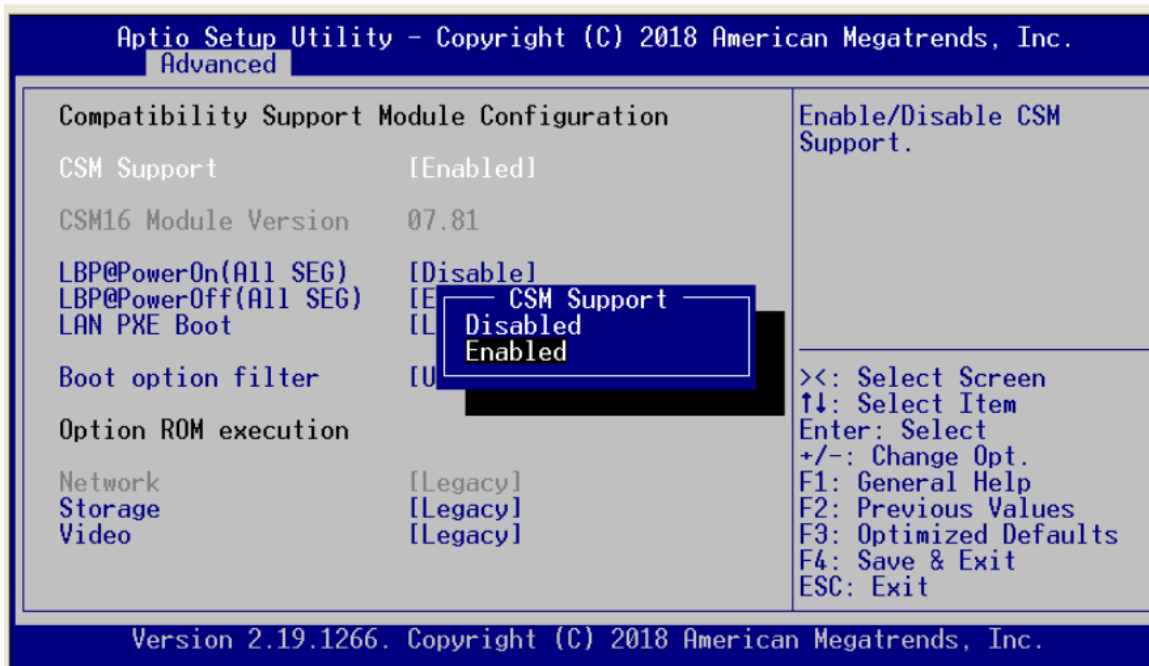
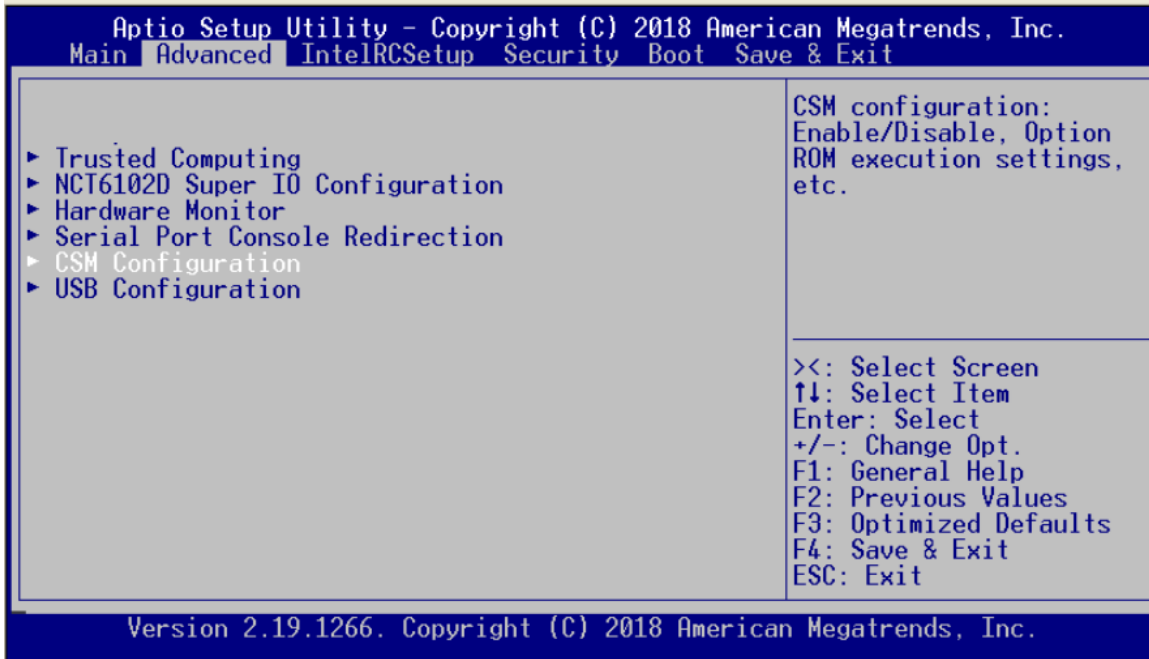

## Lanbypass Mode Configuration

### LAN bypass Mode @power On

Use this item to select lanbypass to “disabled” or “enabled” or keep “Last State.”

### Lanbypass Mode @power OFF

Use this item to select lanbypass to “disabled” or “enabled” or keep “last state.”

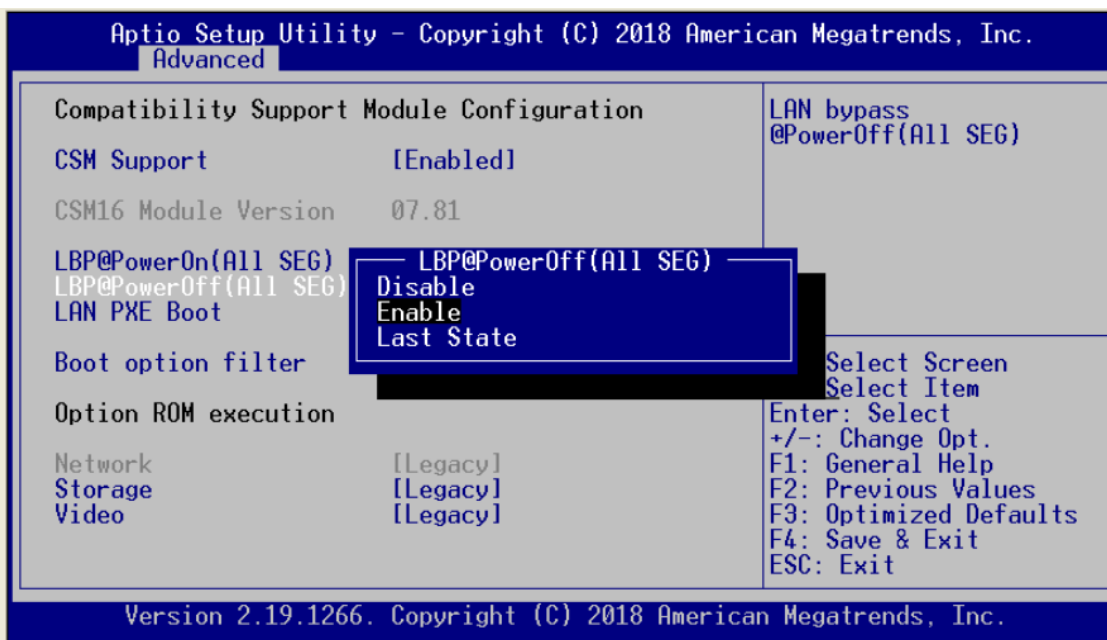
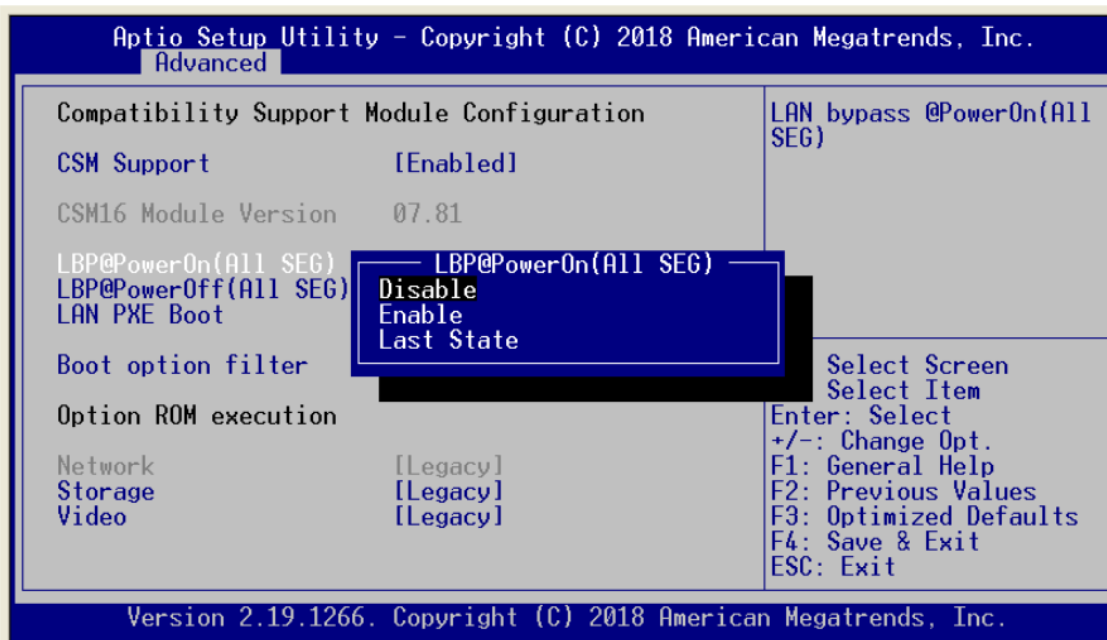

### LAN PXE Boot

This item can enable or disable boot option for legacy mass storage devices with option ROM. In LAN PXE Boot control menu and select LAN port from LAN1~LAN6 for PXE ROM Boot to server or Disables it.

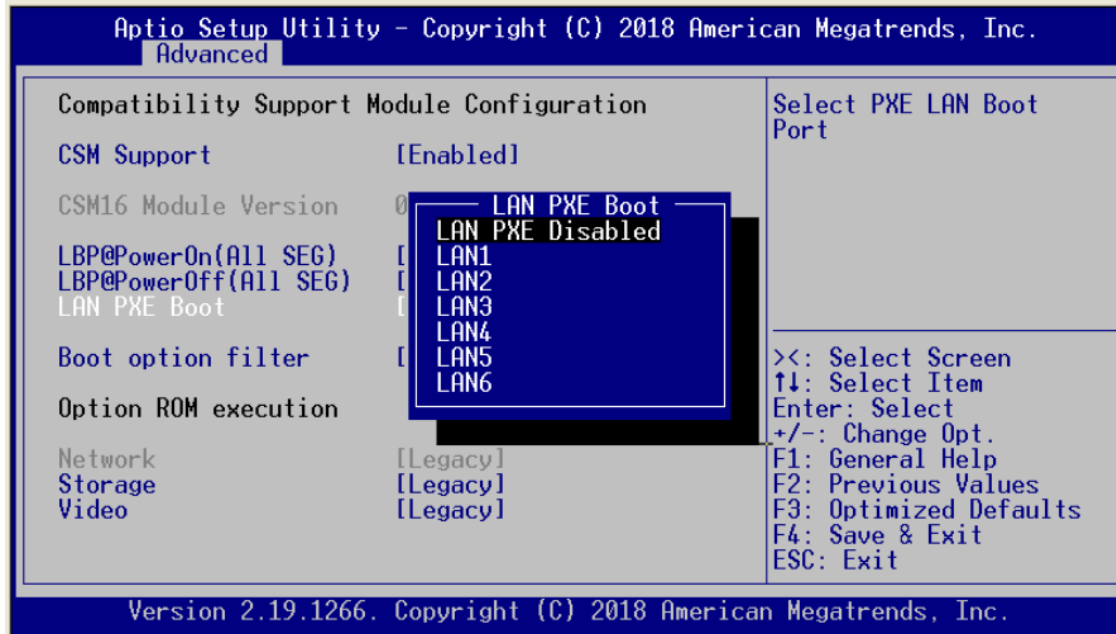

### Boot option filter

This option controls legacy/UEFI ROMs priority. Selects boot option from Boot option filter menu.

 **NOTE:** UEFI is Unified Extensible Firmware Interface. It replaces the BIOS firmware interface originally present in legacy BIOS.

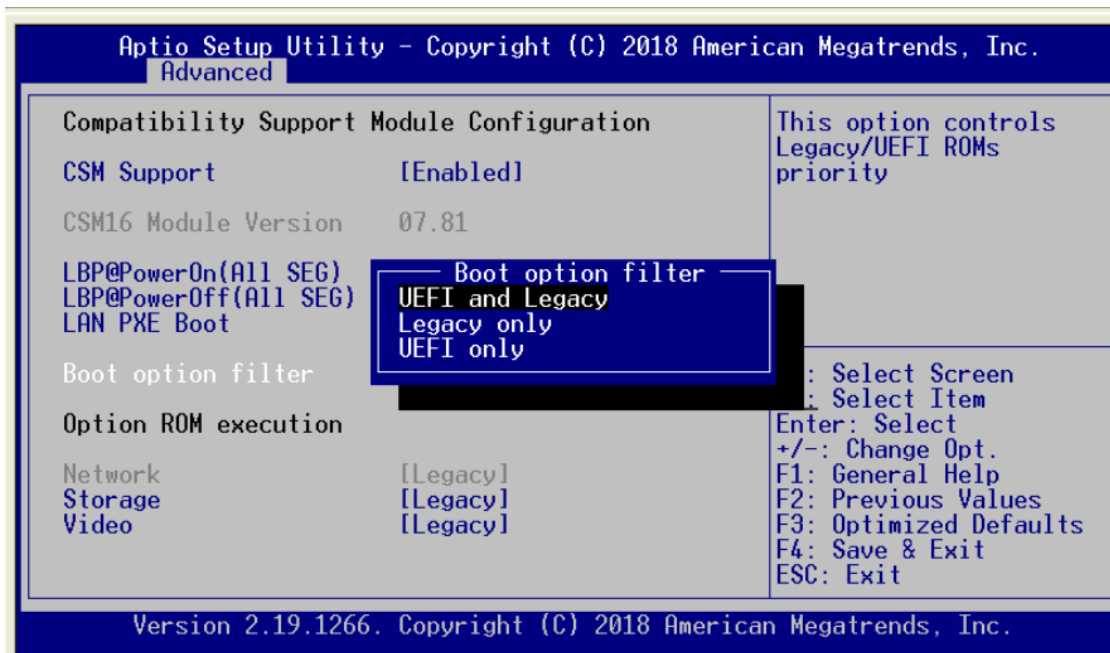

**Option ROM execution**

Controls the execution of UEFI and Legacy storage OpROM.

 **NOTE:** *OpROM: Option ROM, it consists of firmware that is called by system BIOS. OpROM may be from network (PXE ROM or UEFI UNDI driver...etc.), storage (Raid ROM...etc.) or Video (vbios or GOP driver...etc.)*

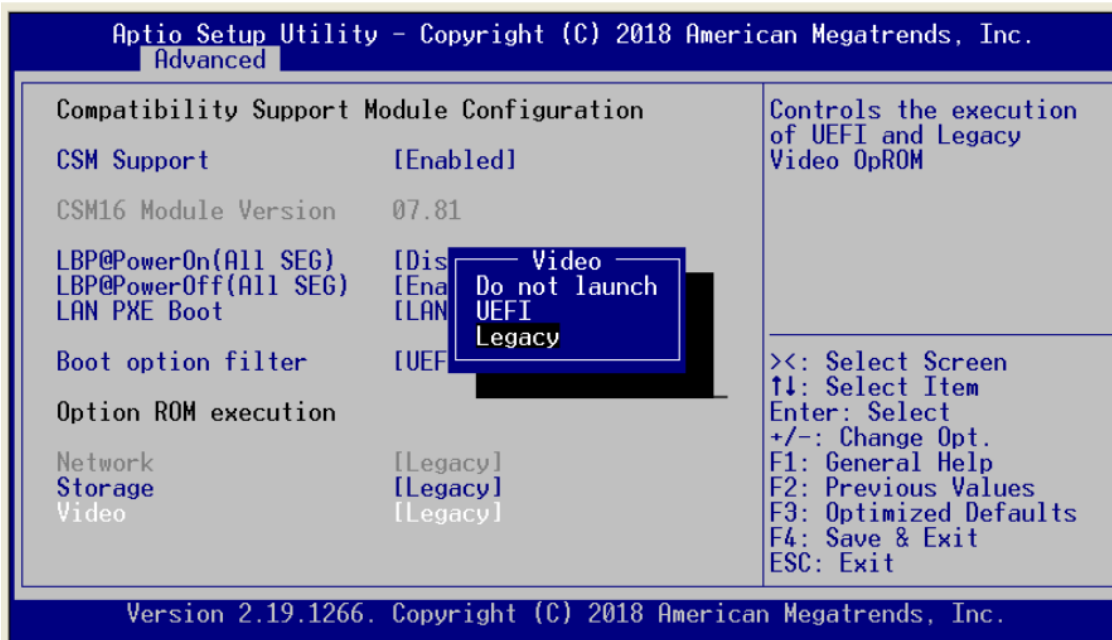
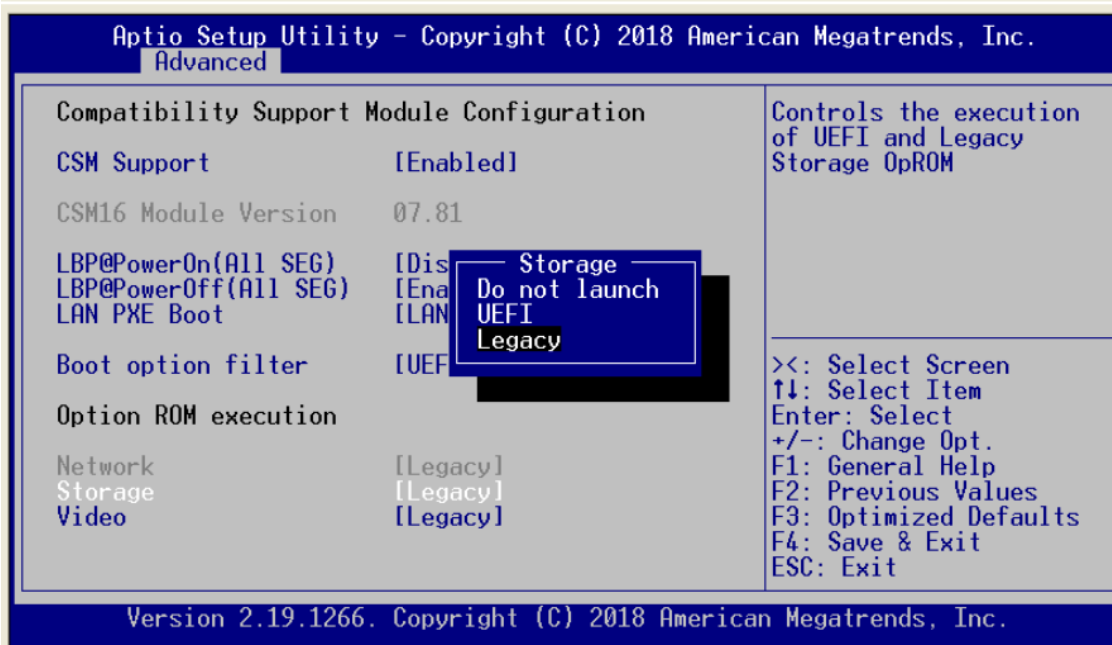



## USB Configuration

Select this item to set up USB related parameter.

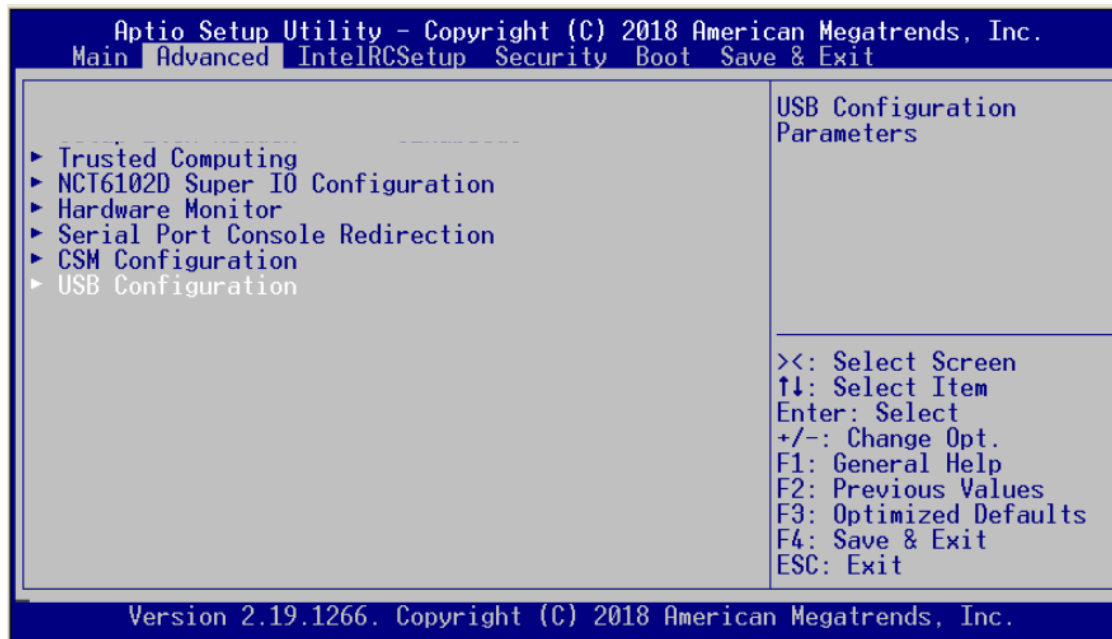

## Legacy USB support

Enables legacy USB support (like USB, KB/MS); Auto option disables legacy support if no USB device are connected; Disable option will keep USB device available only for EFI applications.

 **NOTE:** EFI (Extensible Firmware Interface) OS: Win 10 x64; EFI Shell: MS DOS for example

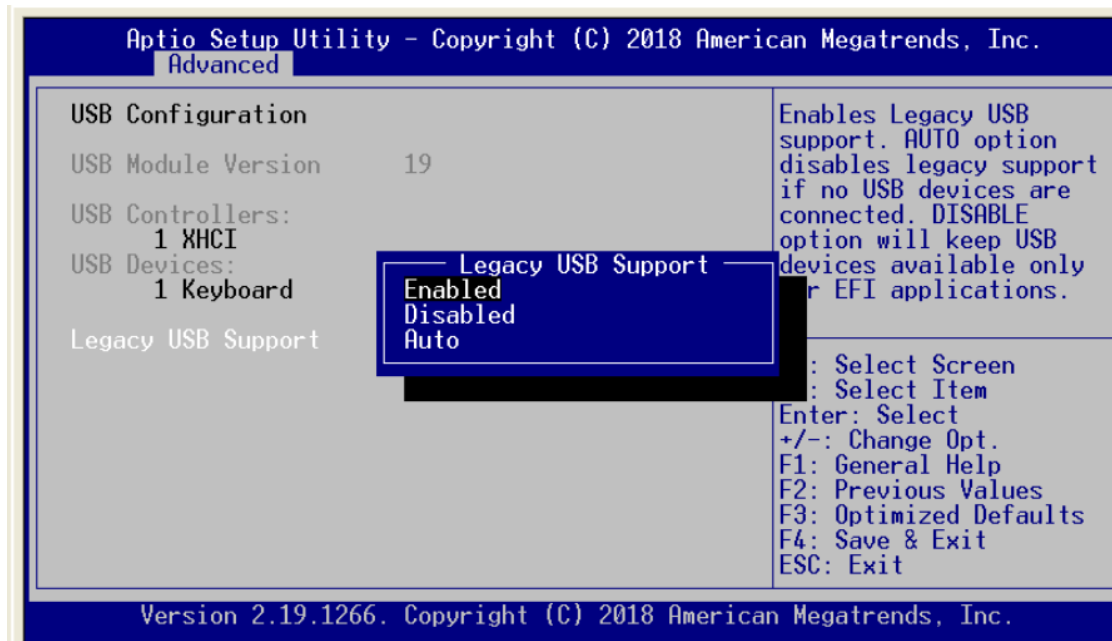

### 3.5 IntelRCSetup

#### Processor Configuration

Displays processor information and provides option to change the processor setting.

Enable or disable EIST (GV3). TM1 must be enabled for TM2 to be available. GV3 must be enabled for Turbo.

**NOTE:** *EIST, Enhanced Intel SpeedStep Technology. It is used to automatically adjust CPU core frequency according to the real loading to reduce power consumption.*

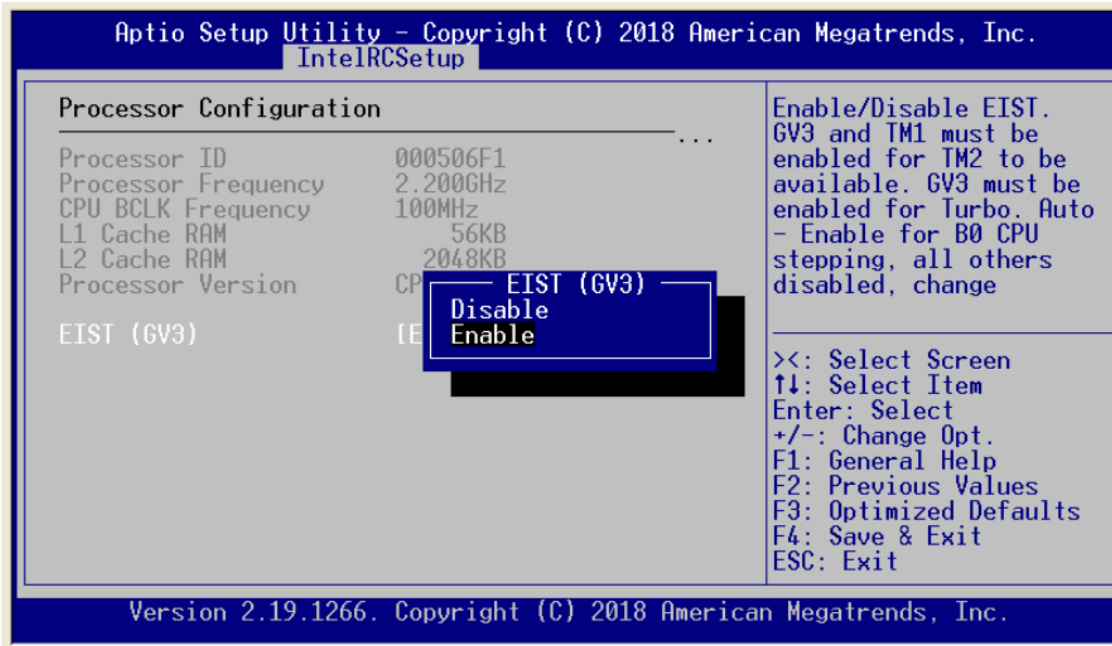
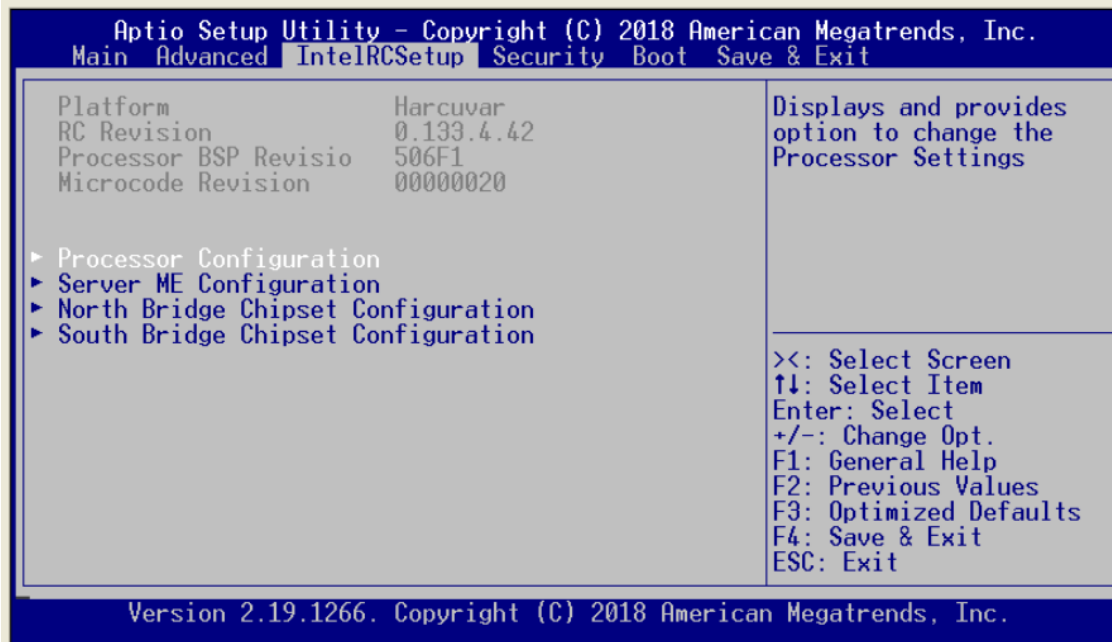

## Server ME Configuration

Configure Server ME Technology parameters. Here show the general ME configuration information.

 **NOTE:** ME, Management Engine. It is Intel's technology used for remote out-of-band management.

```

Aptio Setup Utility - Copyright (C) 2018 American Megatrends, Inc.
Main Advanced IntelRCSetup Security Boot Save & Exit

Platform          Harcuvar
RC Revision       0.133.4.42
Processor BSP Revisio 506F1
Microcode Revision 00000020

Configure Server ME
Technology Parameters

▶ Processor Configuration
▶ Server ME Configuration
▶ North Bridge Chipset Configuration
▶ South Bridge Chipset Configuration

><: Select Screen
↑↓: Select Item
Enter: Select
+/-: Change Opt.
F1: General Help
F2: Previous Values
F3: Optimized Defaults
F4: Save & Exit
ESC: Exit

Version 2.19.1266. Copyright (C) 2018 American Megatrends, Inc.
    
```

```

Aptio Setup Utility - Copyright (C) 2018 American Megatrends, Inc.
IntelRCSetup

General ME Configuration
Operational Firmware 0B:4.0.4.143
ME Firmware Type     SPS
Backup Firmware Versi N/A
Recovery Firmware Ver 0B:4.0.4.143
ME Firmware Features SiEn
ME Firmware Status #1 0x000F0345
ME Firmware Status #2 0x8811C020
Current State        Operational
Error Code           No Error

><: Select Screen
↑↓: Select Item
Enter: Select
+/-: Change Opt.
F1: General Help
F2: Previous Values
F3: Optimized Defaults
F4: Save & Exit
ESC: Exit

Version 2.19.1266. Copyright (C) 2018 American Megatrends, Inc.
    
```

### North Bridge Chipset Configuration

North Bridge handles high speed interface. For example: RAM and PCIe. Show or configure related information/parameters in this item.

### SSA Configuration

Enable or disable VT-d function.

 **NOTE:** VT-d, stands for "Intel Virtualization Technology for Directed I/O. VT-d is for isolating and restricting device accesses to the owner of the partition managing the device.

 **NOTE:** SSA, System Agent. Intel's naming for North Bridge.

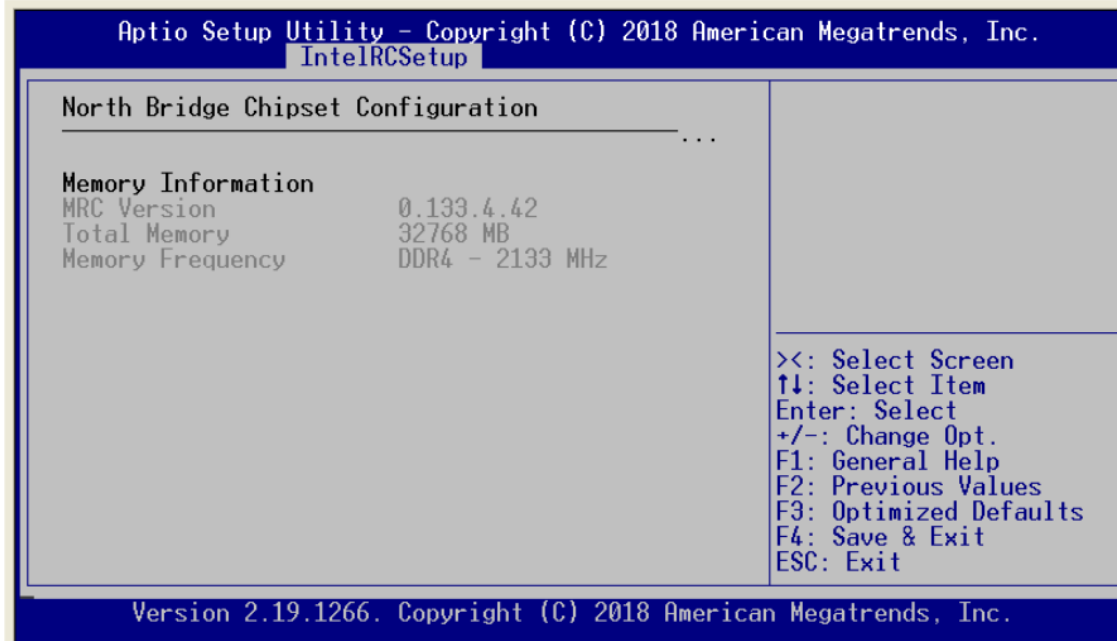
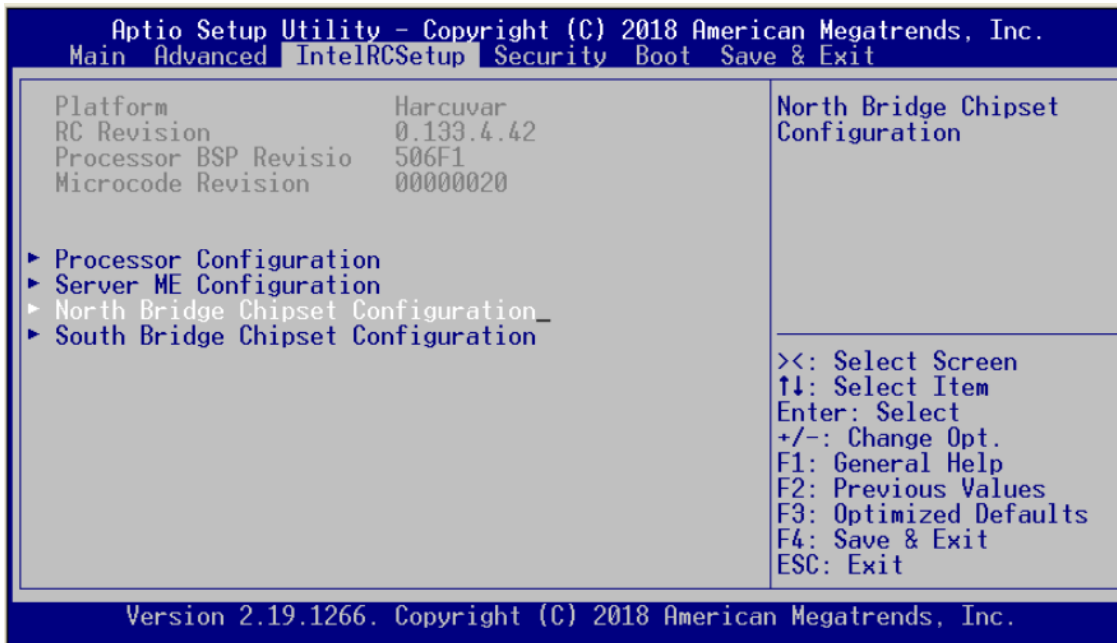

## South Bridge Chipset Configuration

South Bridge handles slow speed I/O interface. Configure related parameters in this item.

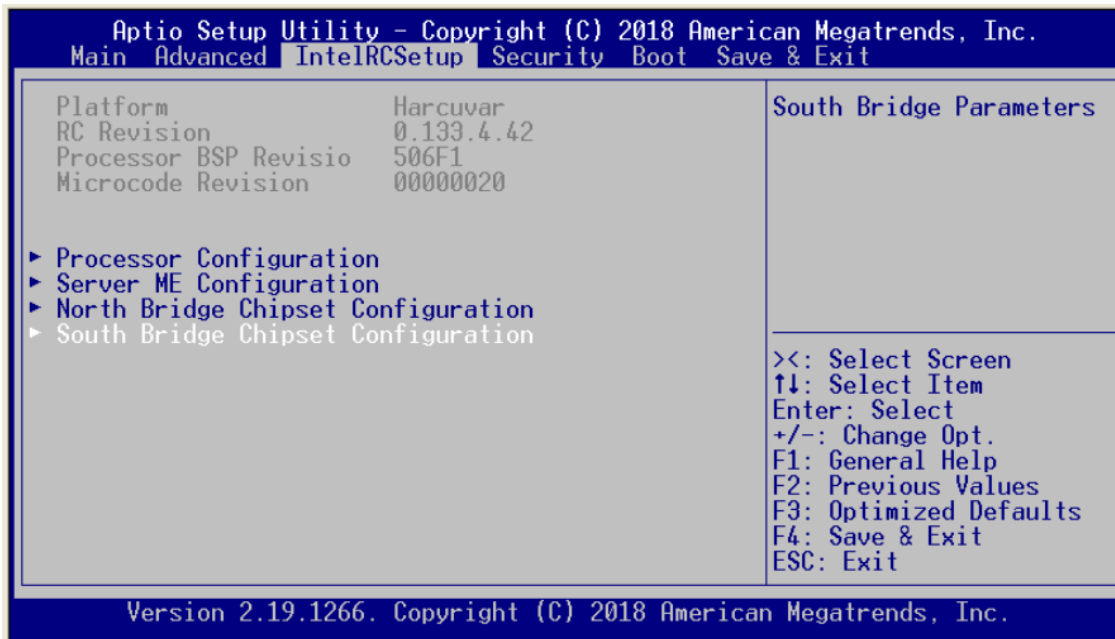

## SATA Configuration

There are options for South Bridge SATA configuration.

### Enable SATA Controller

Enable or disable SATA controller if supported by current CPU SKU. There are SATA and mSATA devices list. Select one to show information of SATA device. Enable or disable SATA device.

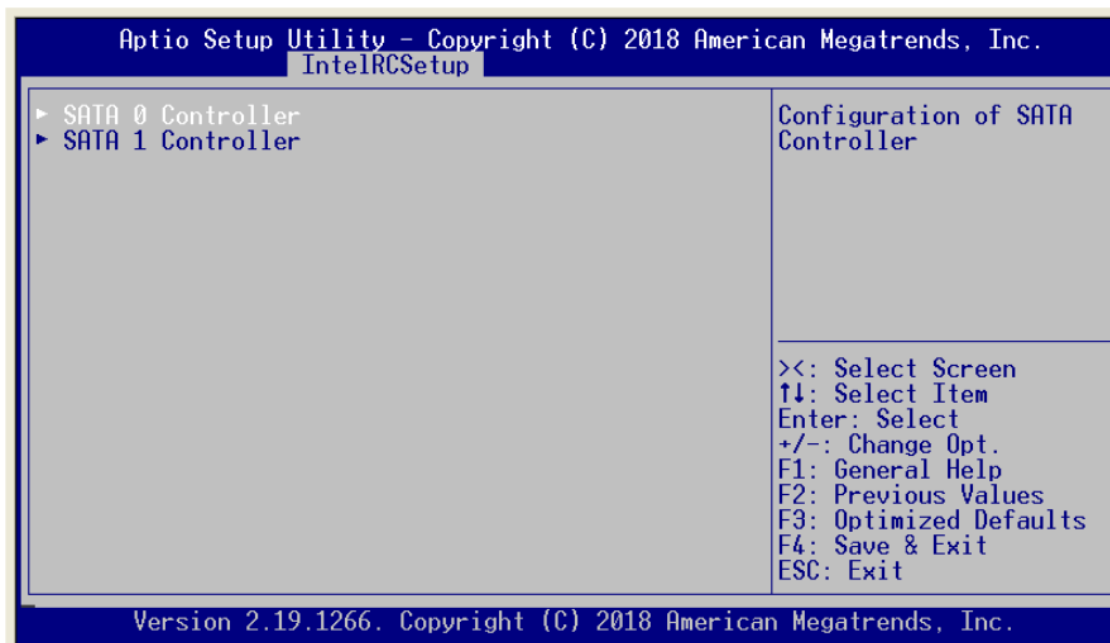
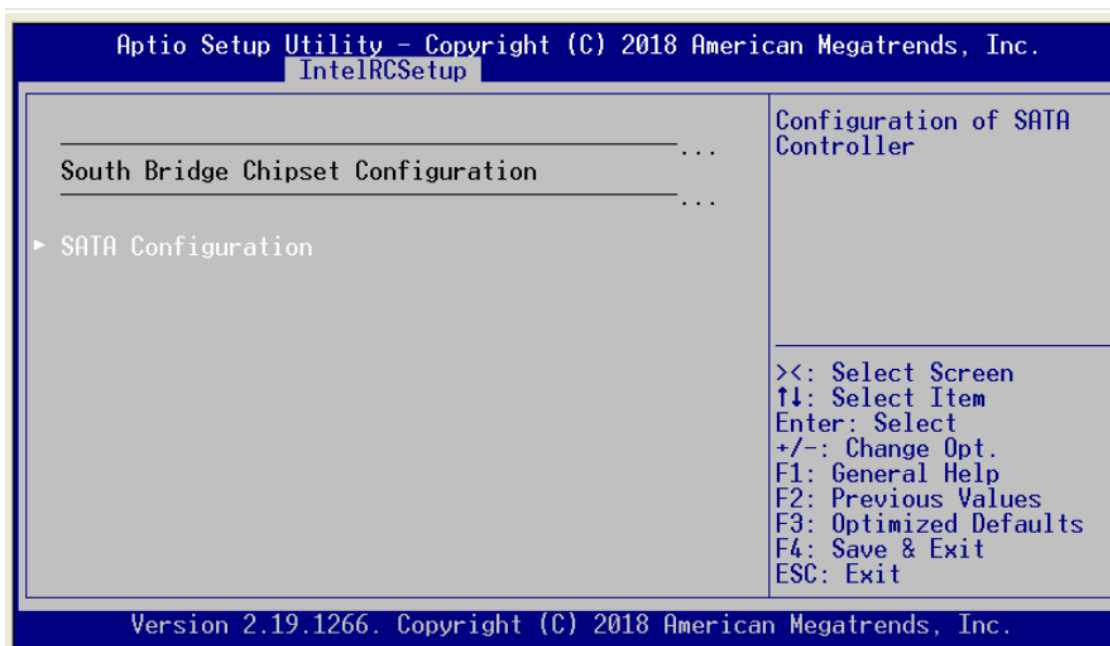

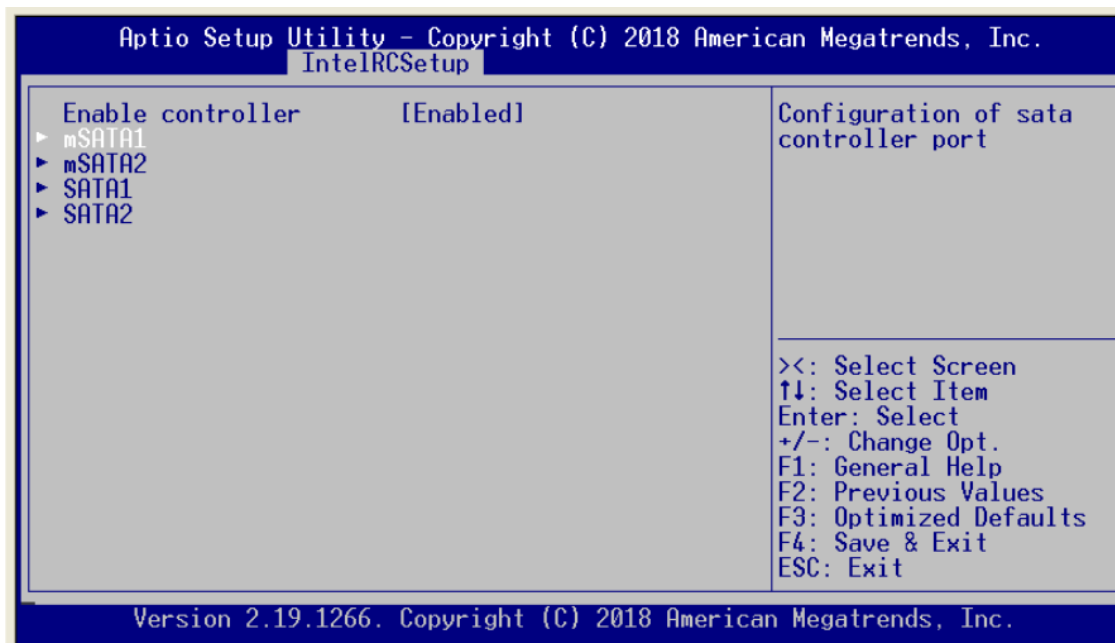
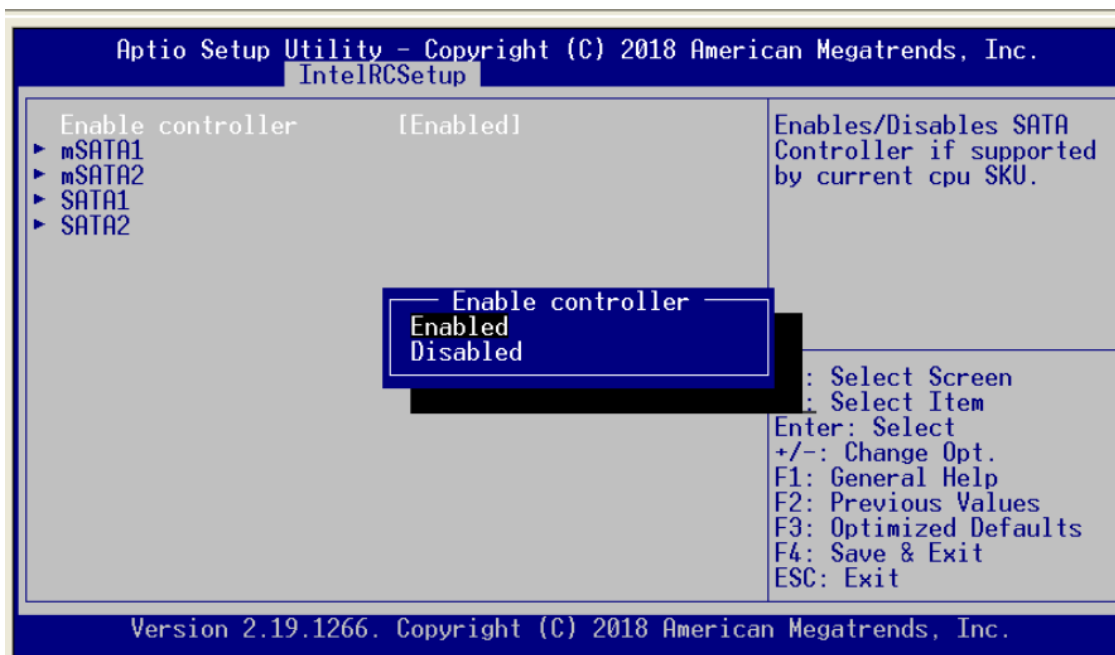

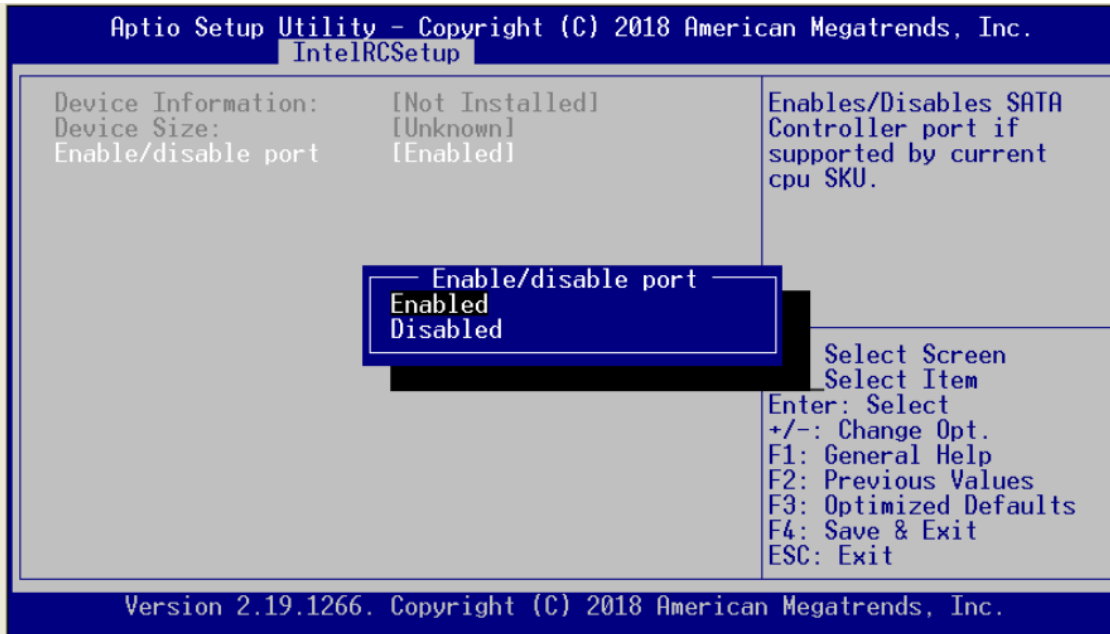

### 3.6 Security Menu

The Security menu allows users to change the security settings for the system.

#### Administrator Password

This item indicates whether an administrator password has been set (installed or uninstalled).





### 3.7 Boot Menu

The Boot menu allows users to change boot options of the system. You can select any of the items in the left frame of the screen to go to the sub menus:

For items marked with “▶”, please press <Enter> for more options.

#### Boot Configuration

##### Setup Prompt Timeout

Number of seconds to wait for setup activation key.

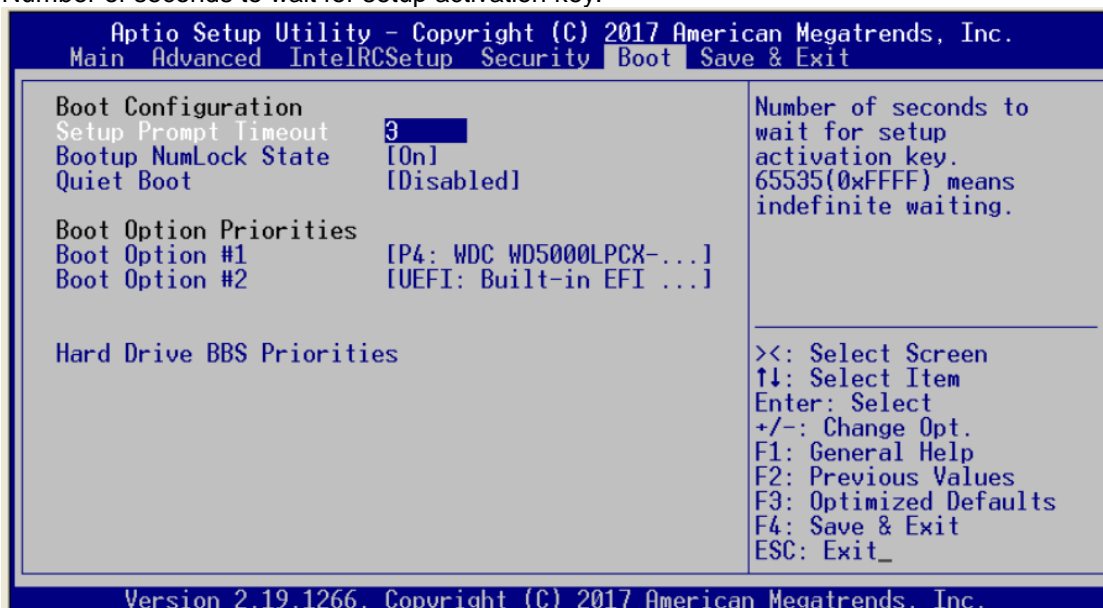

**Boot Num-Lock**

Use this item to select the power-on state for the NumLock. The default setting is *on*.

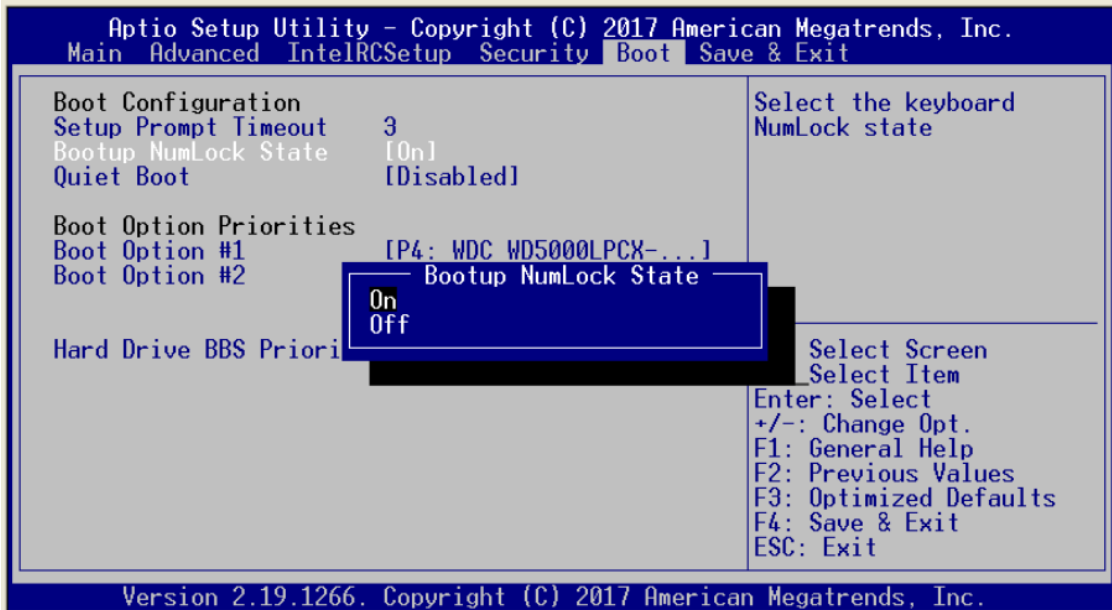

**Quiet Boot**

Enable or disable quiet boot option.

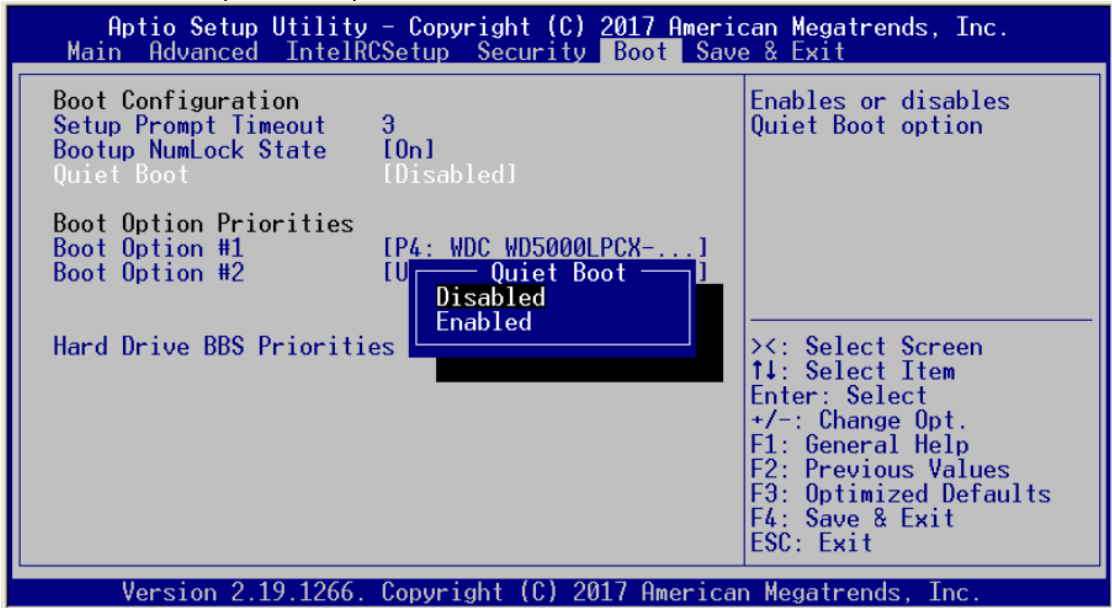

### Boot Option Priorities

#### Boot Option #1 / Boot Option #1

Setup the system boot order.

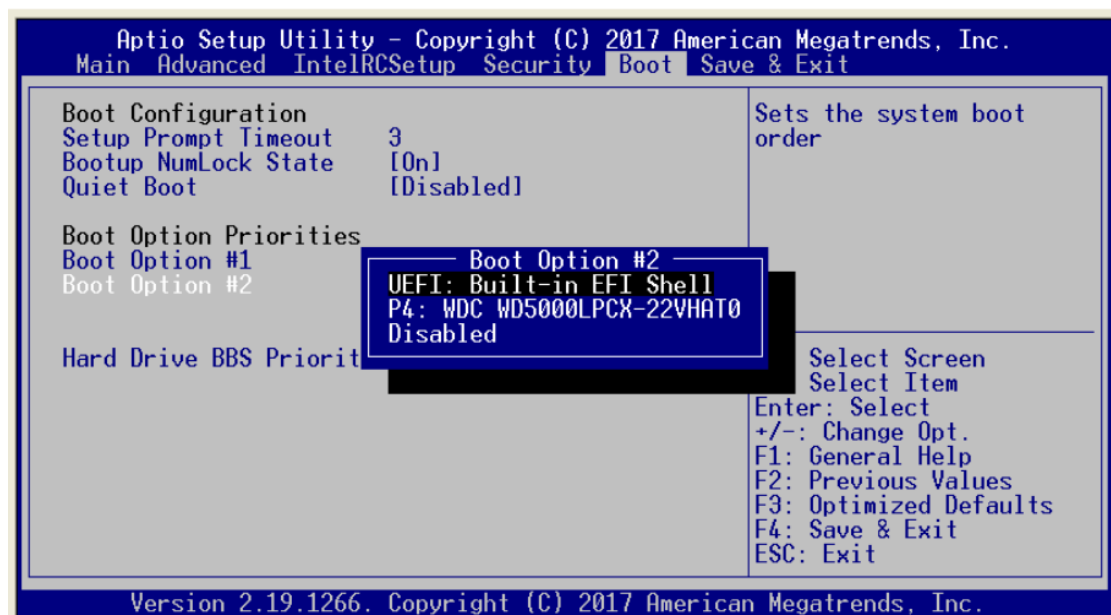
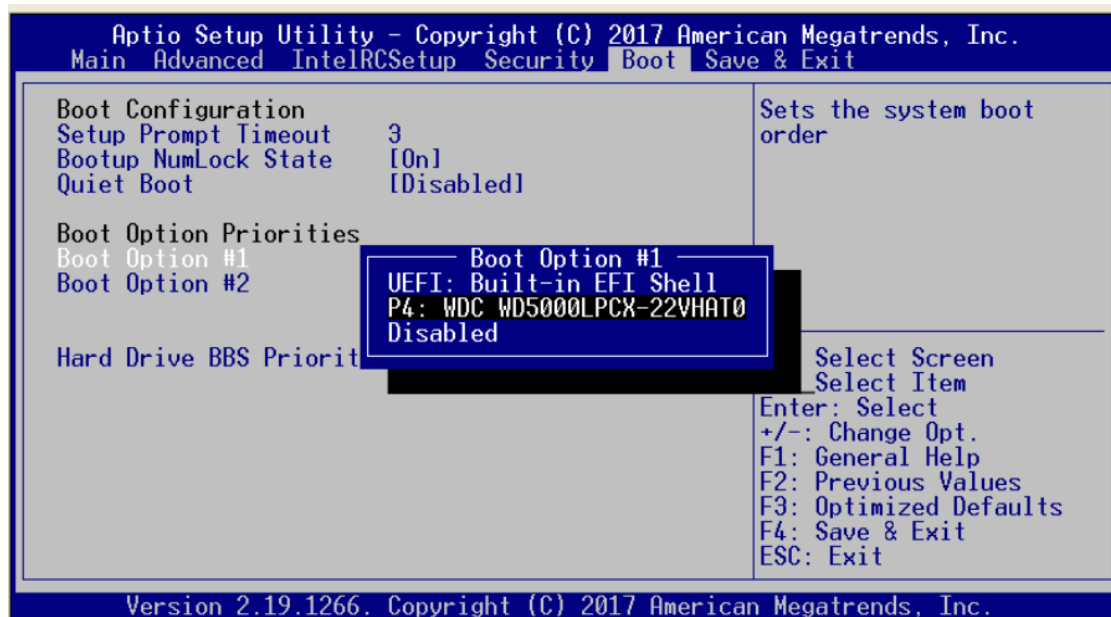

### Hard Drive BBS Priority

Setup the order of the legacy devices here.

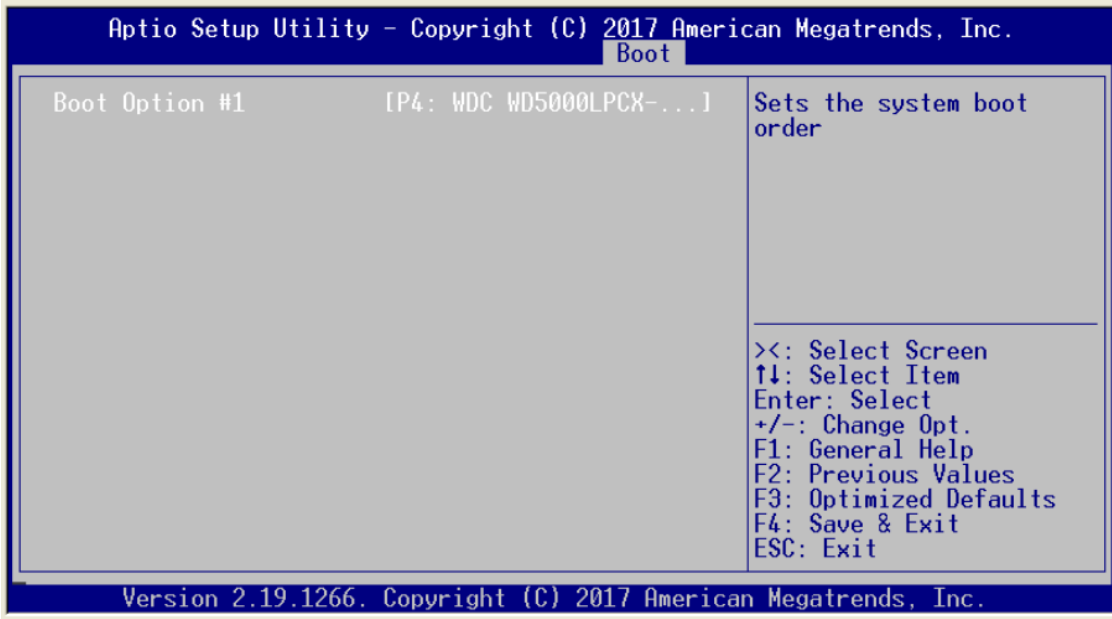
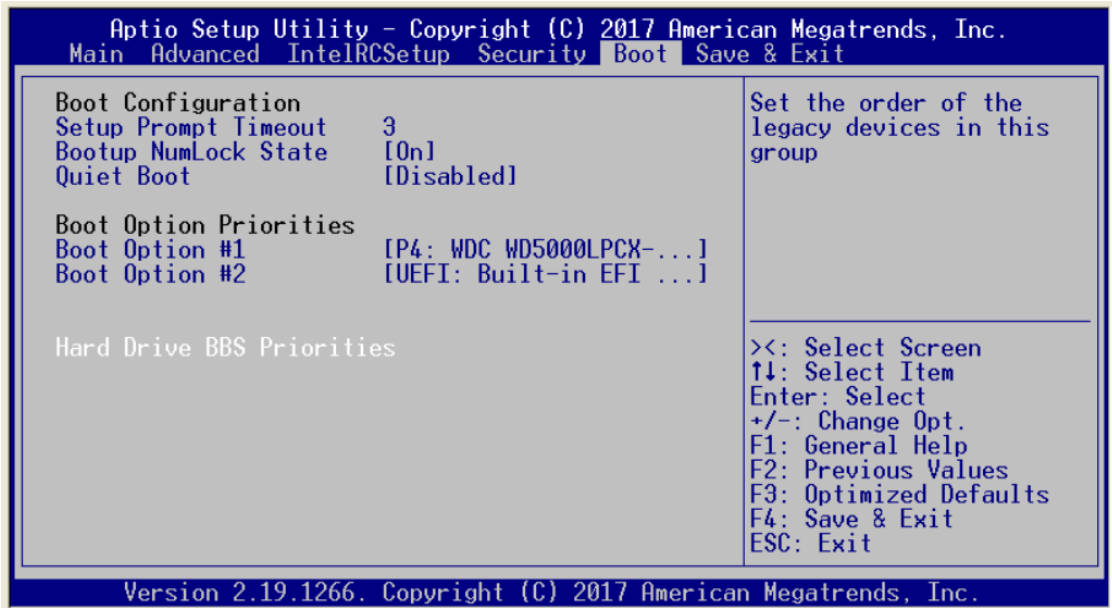

### 3.8 Save & Exit Menu

The Exit menu allows users to load your system configuration with optimal or failsafe default values.

#### Save Options

#### Save Changes and Exit

When you have completed the system configuration changes, select this option to leave Setup and reboot the computer so the new system configuration parameters can take effect. Select *Save Changes and Exit* from the Exit menu and press <Enter>. Select Ok to save changes and exit.

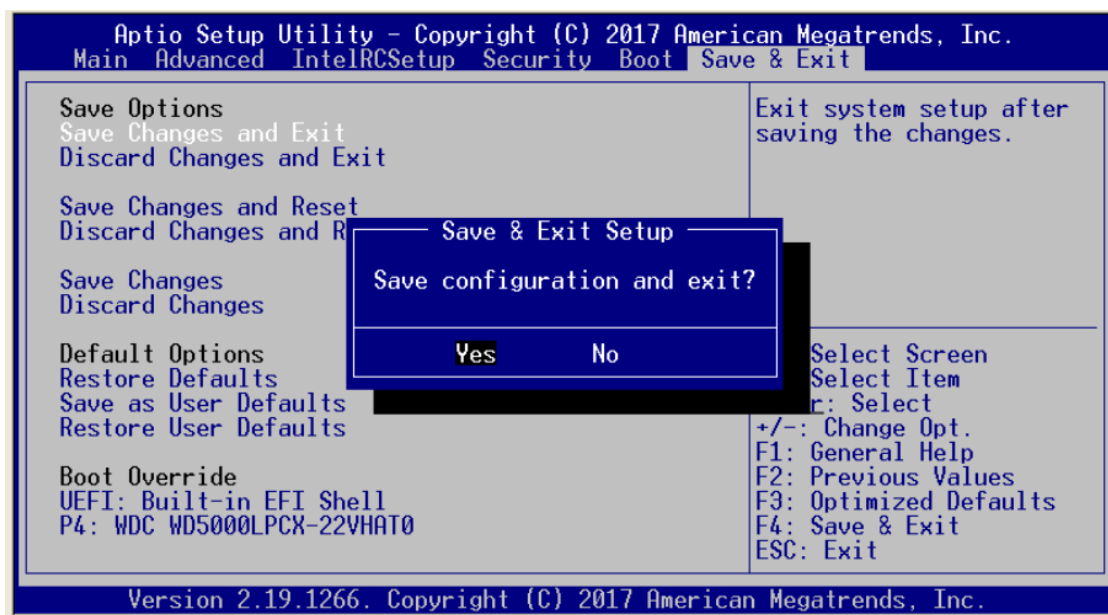

### Discard Changes and Exit

Select this option to quit Setup without making any permanent changes to the system configuration. Select *Discard Changes and Exit* from the Exit menu and press <Enter>. Select Ok to discard changes and exit.

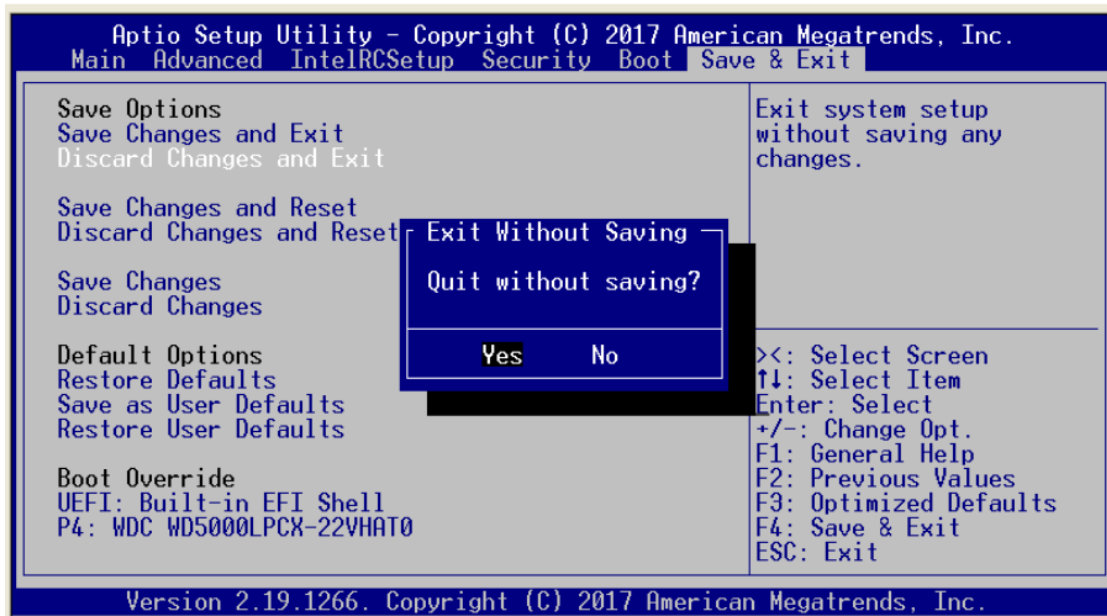

**Save Changes and Reset**

Reset the system after saving the changes.

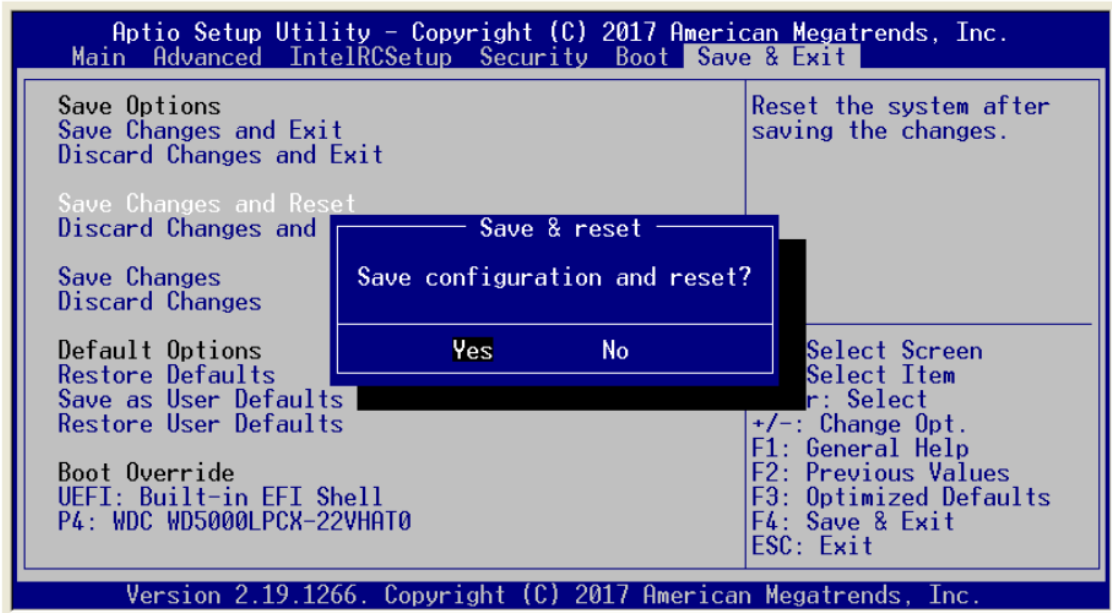

**Discard Changes and Reset**

Reset system setup without saving any changes.

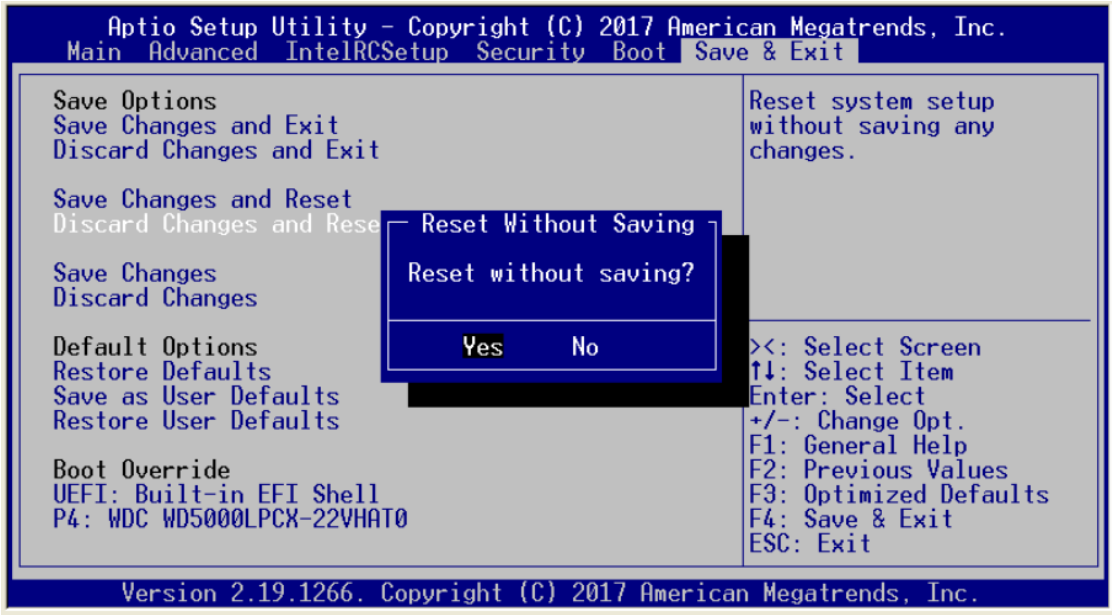

### Save Changes

Save Change done so far to any of the setup options.

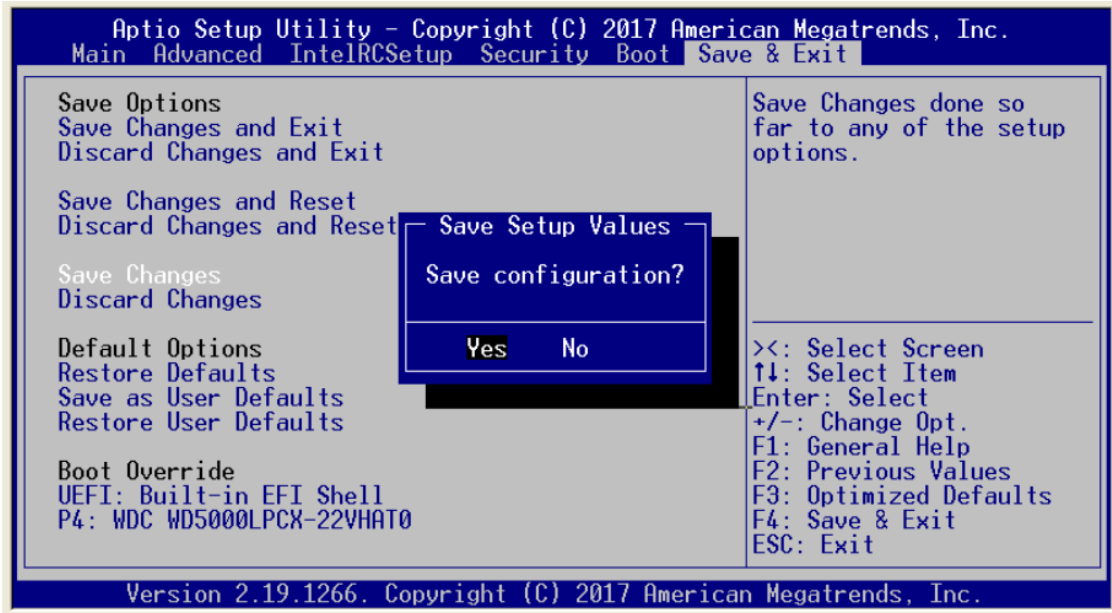

### Discard Changes

Use this item to abandon all changes.

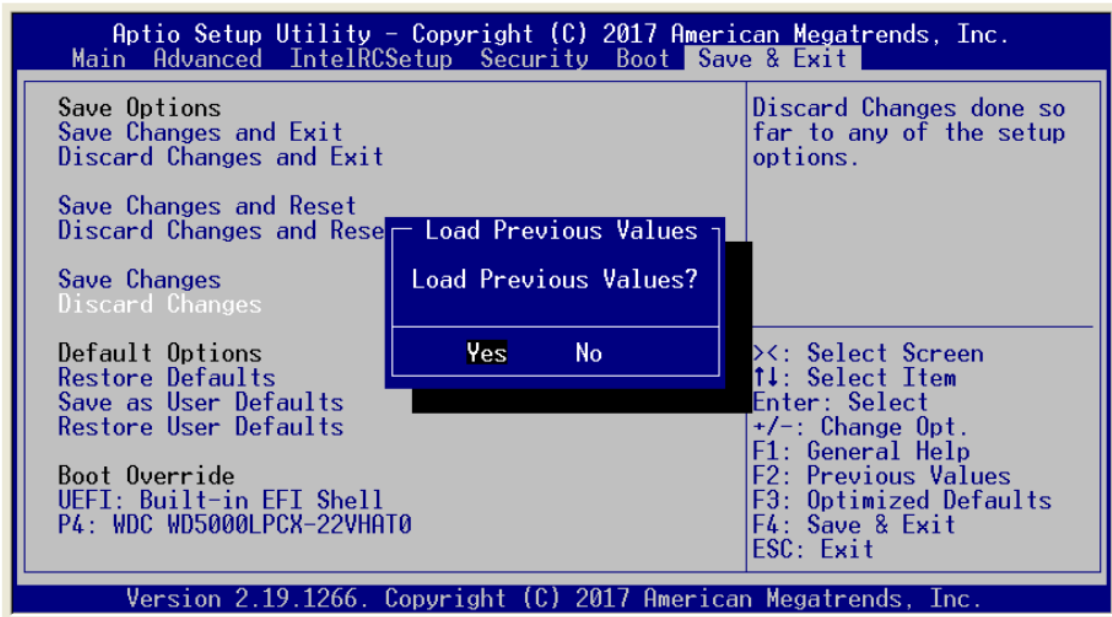



## Default Options

### Restore Defaults

Restore/Load default value for all the setup options.

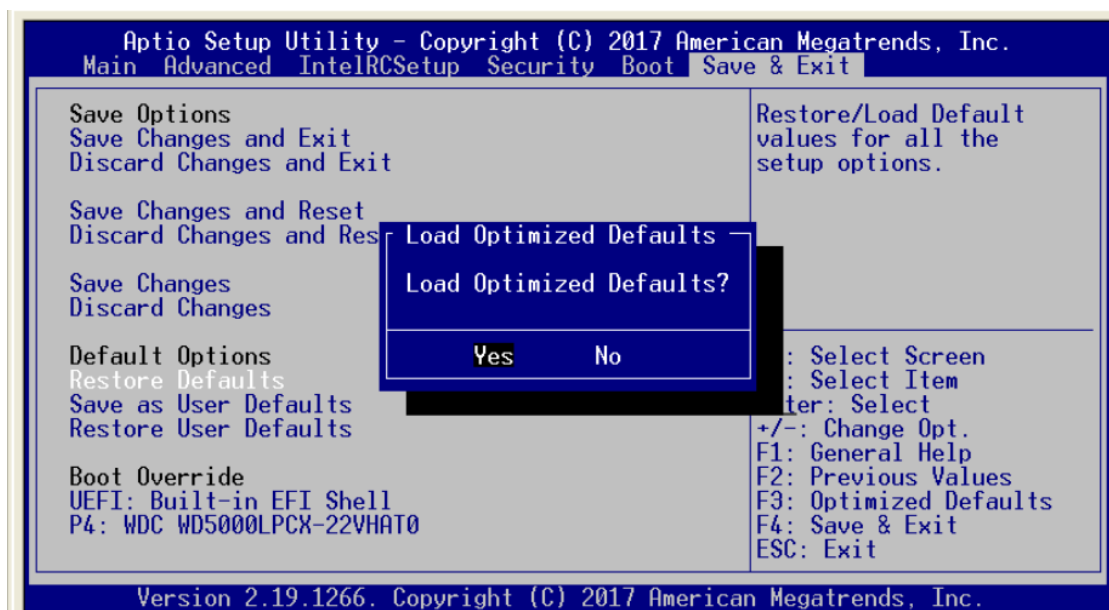

### Save as User Defaults

Save the changes done so far as User Defaults.

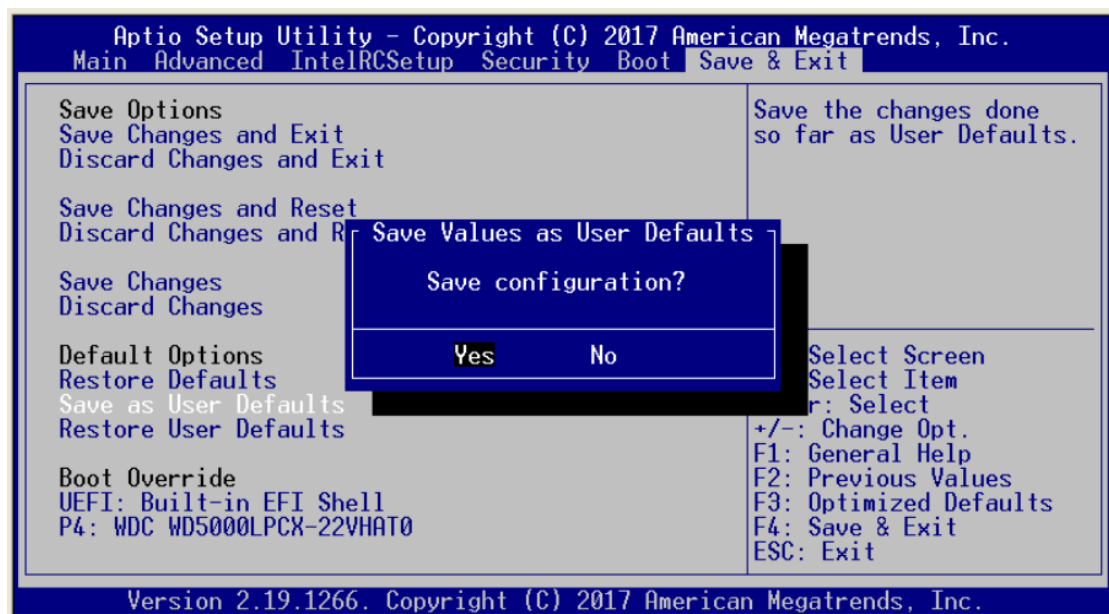

### Restore User Default

Restore the User Default to all the setup options.

 **NOTE:** There are 2 kind of BIOS default setting: factory default and optimized default.

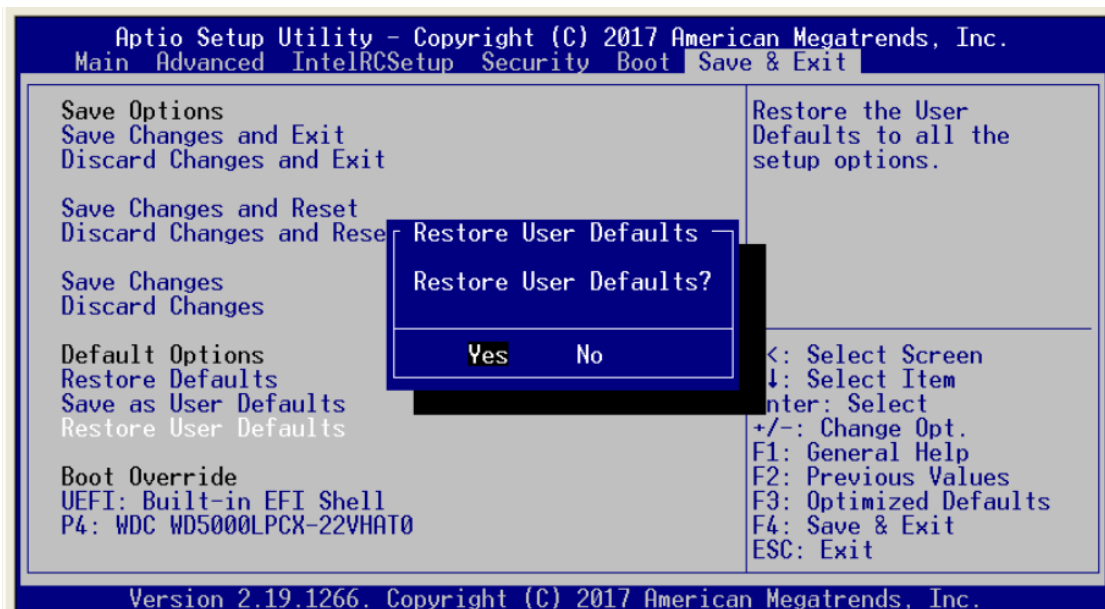

## Boot Override

Launch EFI Shell from filesystem device

Attempts to launch EFI shell application (Shellx64.efi) from one of the available filesystem device.

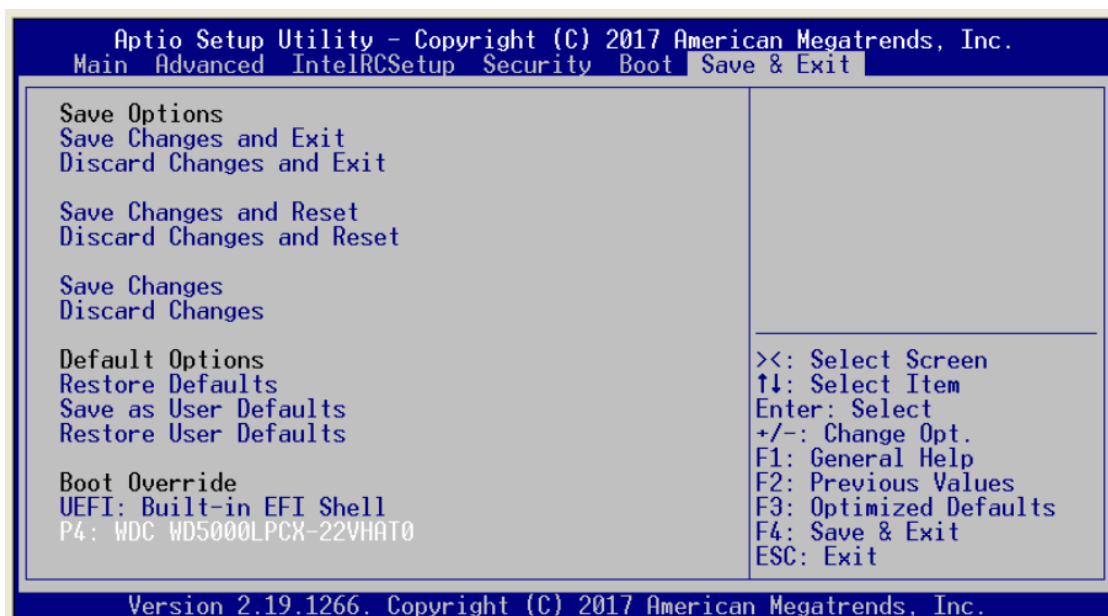
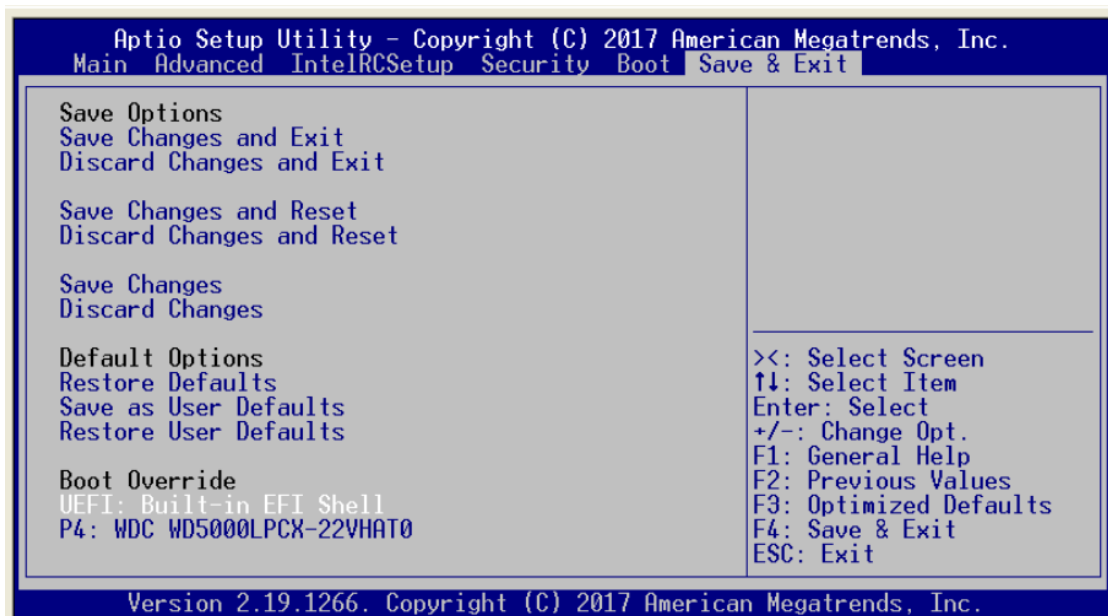

**This page is intentionally left blank.**

## APPENDIX A LAN BYPASS CONFIGURATION

### About LAN Bypass

In network security application, it is very important to ensure that network traffic to continue passing through the device even if a hardware failure occurs or operating system crashes. LAN bypass gives us a solution for this problem.

The NA363R series LAN bypass function is very flexible. It can be selected at any time and any stage. You can enable LAN bypass for power on state by jumper, BIOS, or by software program when entering into the OS. Moreover, for power off state, you can set up LAN Bypass through BIOS, or use software program when entering into the OS. If you don't make any change, the state will keep the previous power off state.

The NA363R series has LAN bypass capability with the special designed latch relay circuitry. When a LAN bypass function is enabled, a relay closes to act as a bridge to route network data flow between LAN port 1&2/3&4. The bypass feature can be activated immediately or according to timer which is configurable from 1 up to 64 seconds. You can write a software program to control bypass operation behavior to fit your requirement.



***NOTE: If you need sample codes, please contact our FAE directly, and they are for reference purposes only.***

## LAN Bypass Register Configuration

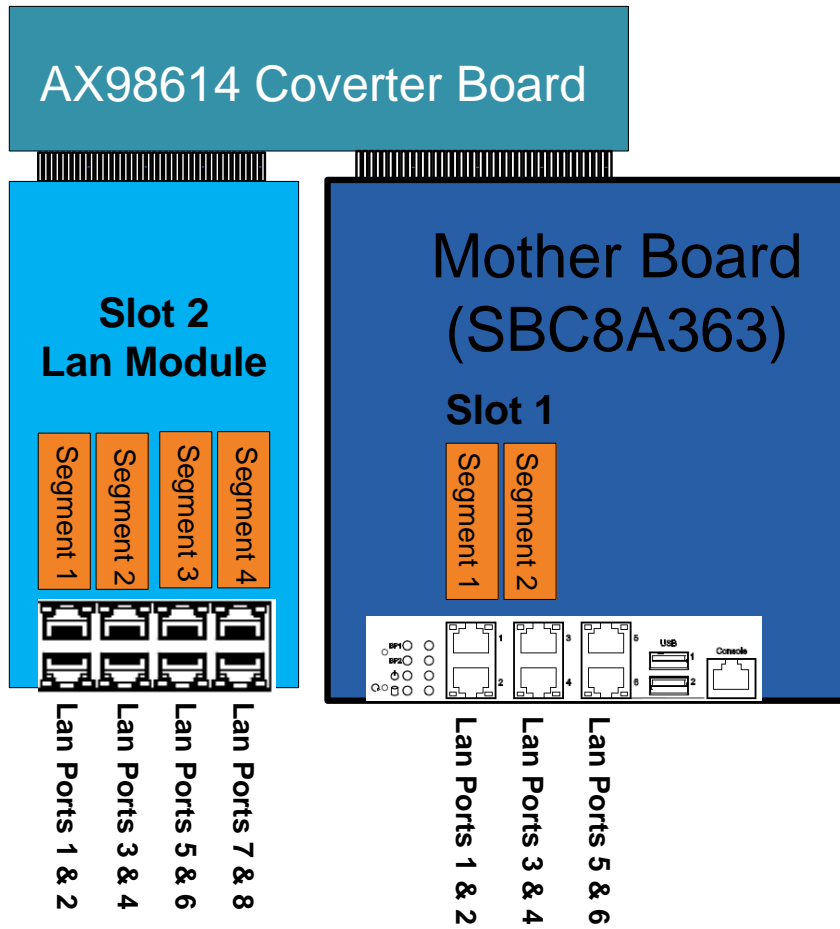

### Power ON Bypass Control Register

Address:

Mother board/Slot1	LAN module/Slot2
0x8E0	0x8E4

7	6	5	4	3	2	1	0
BYM1	BYM0	X	X	3	2	1	0
W	W	--	--	SEGN4	SEGN3	SEGN2	SEGN1

Default value: 00000000

Bit 7~6 BYM1~0

These bits are used to set bypass mode.

00 Not used.

01 Force bypass enable

- The relay closes immediately to form LAN bypass on selected segment when power on.
- 10 Force bypass disable  
LAN bypass is disabled immediately on selected segment when power on.
- 11 Timer enable  
When power on, the selected segments are controlled by the setting of LAN bypass Timer Control register.

Bit 5~4 Not used

Bit 0~3 SEGN1~4

Select each segment by setting the corresponding bit to 1. When the bit is set to 0, no action happens upon the segment.

 **NOTE:** *Mother board support SEGN1 for LAN1 and LAN2/ SEGN2 for LAN3 and LAN4 only*

Data read back from this register is not defined and therefore must be ignored. Reading from this register makes no effect on LAN bypass function. All data in this register will be cleared when the system is turned off. If you still want to use the power on LAN bypass function, turn on the system and make sure to rewrite the register. Otherwise, if you don't rewrite the register, the status will be kept on last status.

**Power OFF Bypass Control Register**

Address:

Mother board/Slot1	LAN module/Slot2
0x8E1	0x8E5

7	6	5	4	3	2	1	0
X	X	X	X	SEGF4	SEGF3	SEGF2	SEGF1
--	--	--	--	W	W	W	W

Default value: 00000000

Bit 4~7 Not used.

Bit 0~3 SEGF1~4

Use the corresponding bit to configure each segment. Setting the bit to 1 enables LAN bypass on the segment when power off. Clearing the bit to 0 disables LAN bypass on the segment when power off.



**NOTE:** Mother board support SEGF1 for LAN1 and LAN2/ SEGF2 for LAN3 and LAN4 only.

Data read back from this register is not defined and therefore must be ignored. Reading from this register makes no effect on LAN bypass function. When the system is turned off, last data written onto this register will be kept. If you want to make any change, turn on the system and make sure to reconfigure the register.



## LAN Bypass Timer Control Register

### Address:

Mother board/Slot1	LAN module/Slot2
0x8E2	0x8E6

7	6	5	4	3	2	1	0
TEXP	X	X	X	X	TVAL2	TVAL1	TVAL0
R	--	--	--	--	W	W	W

Default value: 00000000

Bit 7 TEXP (Read Only)

This bit indicates the status of hardware timer.

0 Timer has not expired

1 Timer has expired

Bits 6~3 Not used.

Bits 2~0 TVAL2~0

These bits determine the amount of count value in second(s).

001 1 (sec)

010 2 (sec)

011 4 (sec)

100 8 (sec)

101 16 (sec)

110 32 (sec)

111 64 (sec)

000 Timer is not activated.

Writing a value to these bits will reset the hardware timer. The counting process begins again according to the new written value. Software must write count value periodically to ensure that timer will never expire. If timer timeout occurs, relay(s) automatically close to form LAN bypass on selected segment(s) based on the setting of Power On Bypass Control register (SEGN1).

 **NOTE:** Mother board support SEGN1 for LAN1 and LAN2/ SEGN2 for LAN3 and LAN4 only

Data (bits 6~0) read back from this register is not defined and therefore must be ignored. A read operation upon this register should not refresh the hardware timer.

### LAN Bypass Status Register

Address:

<b>Mother board/Slot1</b>	<b>LAN module/Slot2</b>
<b>0x8E3</b>	<b>0x8E7</b>

7	6	5	4	3	2	1	0
<b>VER3</b>	<b>VER2</b>	<b>VER1</b>	<b>VER0</b>	<b>BY4</b>	<b>BY3</b>	<b>BY2</b>	<b>BY1</b>
R	R	R	R	R	R	R	R

Bit 0 LAN Bypass Seg.1 status → Disable=0; Enable=1

Bit 1-3 Not used

Bit 7~4 Firmware version

Without LAN Bypass function=1111

## APPENDIX B

### WDT TIMER FOR SYSTEM RESET

#### WDT (Watchdog Timer)

The hardware supports the WDT (Watchdog Timer) function. While time-out happens after a defaulted period, the WDT will reset the system.



**NOTE:** *If you need sample codes please contact our FAE directly, and they are for reference purposes only.*

**This page is intentionally left blank.**

## APPENDIX C

### LAN MODULE EXPANSION



You can install LAN module(s) into NA363R front-accessible expansion slots to meet your application requirement. Here are some LAN module configurations for your selection:

- **LAN Modules**

Slim Module	Ports	Chipset	Bypass	NA363R
<b>GbE Copper Modules</b>				
AX93316-8GI	8	Intel 82580EB	0	v
AX93316-8GIL	8	Intel 82580EB	4	v
AX93336-4GI	4	Intel i210AT	2	v
AX93336-4GIL	4	Intel i350	2	v
<b>GbE Fiber Modules</b>				
AX93322-8FI	8	Intel 82580EB	0	v
AX93322-8MIL	4+4	Intel 82580EB	2	v
AX93336-4FI	4	Intel i350	0	v
<b>10GbE Copper Modules</b>				
AX93317-2GIL	2	Intel X540	1	v
<b>10GbE Fiber Modules</b>				
AX93307-2FI	2	Intel 82599ES	0	v
AX93307-2FIL	2	Intel 82599ES	1	v
AX93327-4FI	4	Intel XL710	0	v

## LAN Bypass Control Jumper (JP2/JP3)

Use this jumper to select the LAN Bypass Function.

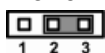
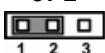
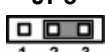
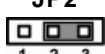
Description	Function	Jumper
LAN Bypass Trigger when Power On	All SEG. Bypass as same as Power Off status	<p><b>JP3</b></p>  <p><b>JP2</b></p> 
	All SEG Bypass Disable(Default)	<p><b>JP3</b></p>  <p><b>JP2</b></p> 
	All SEG Bypass Enable	<p><b>JP3</b></p>  <p><b>JP2</b></p> 



**Note:** When the system is turned on, you can select LAN bypass function by Jumper and Bios when power on state, when enter the OS, you can select LAN bypass function at power on/ off state by software, the detail information please refers to the appendix A.

## LED Definition

### AX93316



### LAN bypass LED

- **LAN bypass LED**

While running the LAN By-Pass function, the LED always lights up.

- **Active LED (Single color) for LAN port #1, port#2, port#3, port#4, port #5, port#6, port#7, port#8**

- The orange LED is on when the LAN port connection is working.
- The LED flashes when transmitting or receiving any signals to or from the appliance.
- The LED is dark when the appliance is off.

- **Link LED for LAN port #1, port#2, port#3, port#4, port#5 and port#6, port#7, port#8**

- The double-color LED light indicates 10/100/1000Mbps transfer rate.
- When the orange-color LED light is radiating, it should be 1000Mbps transfer rate.
- When the green-color LED light is radiating, it should be 100Mbps transfer rate.
- If the Link LED is dark and Active LED is light on or flashing, it should be 10Mbps transfer rate.

When this LED and Link / Active LED both are dark. No networking devices are attached

Transfer Rate	LED Light Color
10Mbps	Dark
100Mbps	Green
1000Mbps	Orange

**AX93336-4GIL**

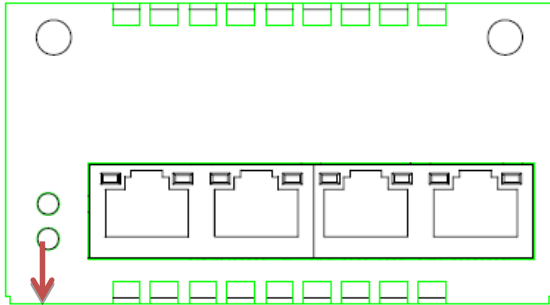

**LAN bypass LED**

- **LAN bypass LED**

While running the LAN By-Pass function, the LED always lights up.

- **Active LED (Single color) for LAN port #1, port#2, port#3, port#4**

- The orange LED is on when the LAN port connection is working.
- The LED flashes when transmitting or receiving any signals to or from the appliance.
- The LED is dark when the appliance is off.

- **Link LED for LAN port #1, port#2, port#3, port#4**

- The double-color LED light indicates 10/100/1000Mbps transfer rate.
- When the orange-color LED light is radiating, it should be 1000Mbps transfer rate.
- When the green-color LED light is radiating, it should be 100Mbps transfer rate.
- If the Link LED is dark and Active LED is light on or flashing, it should be 10Mbps transfer rate.

When this LED and Link/Active LED both are dark. No networking devices are attached

Transfer Rate	LED Light Color
10Mbps	Dark
100Mbps	Green
1000Mbps	Orange



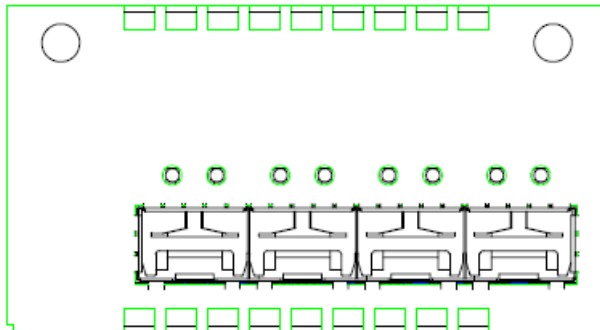

AX93336-4FI

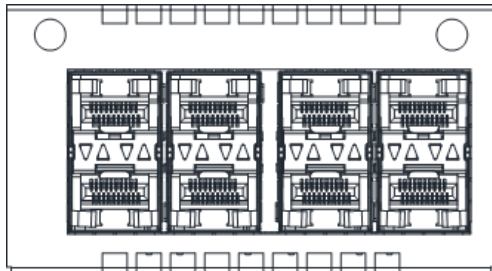

Transfer Rate	LED Light Color
	Fiber port Active: Orange
	Fiber port Link: Orange

**AX93322-8FI**

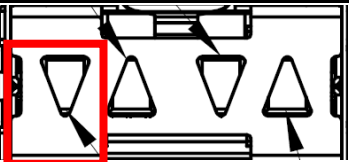
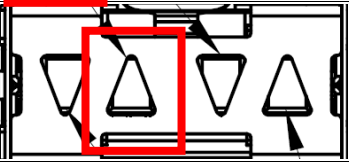



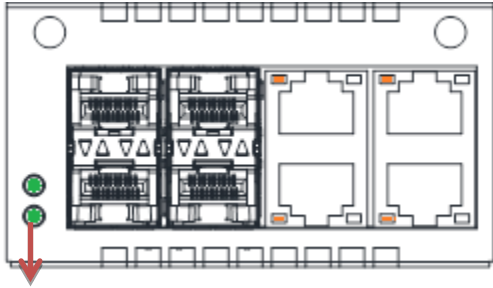

Transfer Rate	LED Light Color
 <p>The diagram shows a fiber port with two LEDs. The top LED is highlighted with a red square, indicating it is the active indicator for this port configuration.</p>	<p>Down Fiber port Active: Orange</p>
 <p>The diagram shows a fiber port with two LEDs. The middle LED is highlighted with a red square, indicating it is the active indicator for this port configuration.</p>	<p>Up Fiber port Active: Orange</p>
 <p>The diagram shows a fiber port with two LEDs. The bottom LED is highlighted with a red square, indicating it is the link indicator for this port configuration.</p>	<p>Down Fiber port Link: Orange</p>
 <p>The diagram shows a fiber port with two LEDs. The top LED is highlighted with a red square, indicating it is the link indicator for this port configuration.</p>	<p>Up Fiber port Link: Orange</p>

AX93322-8MIL

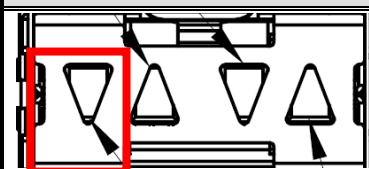

**LAN bypass LED**

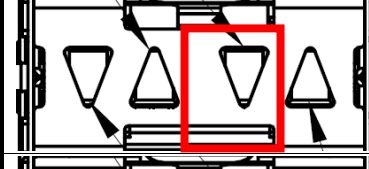
**FIBER:**

Transfer Rate	LED Light Color
	Down Fiber port Active: Orange
	Up Fiber port Active: Orange
	Down Fiber port Link: Orange
	Up Fiber port Link: Orange

**Copper:**

- **LAN bypass LED**

While running the LAN By-Pass function, the LED always lights up.

- **Active LED (Single color) for LAN port #1, port#2, port#3, port#4**

- The orange LED is on when the LAN port connection is working.
- The LED flashes when transmitting or receiving any signals to or from the appliance.
- The LED is dark when the appliance is off.

- **Link LED for LAN port #1, port#2, port#3, port#4**
  - The double-color LED light indicates 10/100/1000Mbps transfer rate.
  - When the orange-color LED light is radiating, it should be 1000Mbps transfer rate.
  - When the green-color LED light is radiating, it should be 100Mbps transfer rate.
  - If the Link LED is dark and Active LED is light on or flashing, it should be 10Mbps transfer rate.

When this LED and Link / Active LED both are dark. No networking devices are attached

Transfer Rate	LED Light Color
10Mbps	Dark
100Mbps	Green
1000Mbps	Orange

#### AX93317

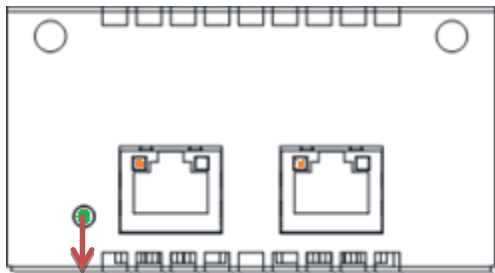

#### LAN bypass LED

- **LAN bypass LED**

While running the LAN By-Pass function, the LED always lights up.
- **Active LED (Single color)for LAN port #1, port#2**
  - The orange LED is on when the LAN port connection is working.
  - The LED flashes when transmitting or receiving any signals to or from the appliance.
  - The LED is dark when the appliance is off.
- **Link LED for LAN port #1, port#2**
  - The double-color LED light indicates 1000/10000Mbps transfer rate.
  - When the orange-color LED light is radiating, it should be 10000Mbps transfer rate.
  - When the green-color LED light is radiating, it should be 1000Mbps transfer rate.

When this LED and Link/Active LED both are dark. No networking devices are attached

Transfer Rate	LED Light Color
1000Mbps	Green
10000Mbps	Orange

### AX93307

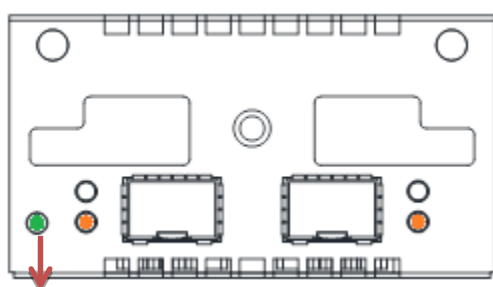

### LAN bypass LED

- **LAN bypass LED**  
While running the LAN By-Pass function, the LED always lights up.
- **Active LED (Single color)for LAN port #1, port#2**
  - The orange LED is on when the LAN port connection is working.
  - The LED flashes when transmitting or receiving any signals to or from the appliance.
  - The LED is dark when the appliance is off.
- **Link LED for LAN port #1, port#2**
  - The double-color LED light indicates 1000/10000Mbps transfer rate.
  - When the orange-color LED light is radiating, it should be 1000Mbps transfer rate.
  - When the green-color LED light is radiating, it should be 1000Mbps transfer rate.

Transfer Rate	LED Light Color
1000Mbps	Green
10000Mbps	Orange

**This page is intentionally left blank.**

## APPENDIX D WARNING

- This is a class A Product. In a domestic Environment this Product may cause radio interference in which case the user may be required to take adequate measures.

- It will be danger if battery is incorrectly replaced. Replacing only with the same or equivalent type is highly recommended by the manufacturer. Dispose of used batteries according to the manufacturer's instructions.

- **Warning for Hard Disk Drive Selection:**  
TUV approved Hard Disk Drive is preferred for TUV compliance Hard Disk drive-Optional, (NWGQ2), generic, Input Voltage rated 5V DC/1.0A, 12V DC/1.8A maximum. Minimum clearance from uninsulated live parts 4.0 mm.

- The equipment is to be installed in an environment with maximum ambient temperature must not exceed 45°C
- The openings on the enclosure are for air convection hence protected the equipment from overheating. DO NOT COVER THE OPENINGS.
- Lay this equipment on a reliable surface when install. A drop or fall could cause injury.
- The equipment shall be installed according to specification as nameplate. Make sure the voltage of the power source when connect the equipment to the power outlet.
- The current of load and output power of loads shall be not over the specification.
- This equipment must be connected to the reliable earthing before using.



**Electric shock hazard inside the redundant power supply.**

The exchange of modules shall be done by service person.

**This page is intentionally left blank.**