

# USER'S MANUAL

**IPC960-525 series**

**IPC962-525 series**

**IPC964-525 series**

**Industrial Computers**

**User's Manual**



[www.axiomtek.com](http://www.axiomtek.com)

## **Disclaimers**

This manual has been carefully checked and believed to contain accurate information. Axiomtek Co., Ltd. assumes no responsibility for any infringements of patents or any third party's rights, and any liability arising from such use.

Axiomtek does not warrant or assume any legal liability or responsibility for the accuracy, completeness or usefulness of any information in this document. Axiomtek does not make any commitment to update the information in this manual.

Axiomtek reserves the right to change or revise this document and/or product at any time without notice.

No part of this document may be reproduced, stored in a retrieval system, or transmitted, in any form or by any means, electronic, mechanical, photocopying, recording, or otherwise, without the prior written permission of Axiomtek Co., Ltd.

**©Copyright 2021 Axiomtek Co., Ltd.**

**All Rights Reserved**

**September 2021, Version A6**

**Printed in Taiwan**

## Safety Precautions

Before getting started, please read the following important safety precautions.

1. The IPC960-525/IPC962-525/IPC964-525 Series does not come equipped with an operating system. An operating system must be loaded first before installing any software into the computer.
2. Be sure to ground yourself to prevent static charge when installing the internal components. Use a grounding wrist strap and place all electronic components in any static-shielded devices. Most electronic components are sensitive to static electrical charge.
3. Disconnect the power cord from the IPC960-525/IPC962-525/IPC964-525 Series before making any installation. Be sure both the system and the external devices are turned OFF. Sudden surge of power could ruin sensitive components. Make sure the IPC960-525/IPC962-525/IPC964-525 Series is properly grounded.
4. Make sure the voltage of the power source is correct before connecting the equipment to the power outlet.
5. Turn OFF the system power before cleaning. Clean the system using a cloth only. Do not spray any liquid cleaner directly onto the screen.
6. Do not leave this equipment in an uncontrolled environment where the storage temperature is below -20°C or above 80°C. It may damage the equipment.
7. Do not open the system's back cover. If opening the cover for maintenance is a must, only a trained technician is allowed to do so. Integrated circuits on computer boards are sensitive to static electricity. To avoid damaging chips from electrostatic discharge, observe the following precautions:
  - Before handling a board or integrated circuit, touch an unpainted portion of the system unit chassis for a few seconds. This will help to discharge any static electricity on your body.
  - When handling boards and components, wear a grounding wrist strap, available from most electronic component stores.

## **Classification**

1. Degree of protection against electric shock: not classified
2. Degree of protection against the ingress of water: none
3. Equipment not suitable for use in the presence of a flammable anesthetic mixture with air or with oxygen or nitrous oxide.
4. Mode of operation: Continuous
5. Type of protection against electric shock: Class I equipment

## **General Cleaning Tips**

You may need the following precautions before you begin to clean the computer. When you clean any single part or component for the computer, please read and understand the details below fully.

When you need to clean the device, please rub it with a piece of dry cloth.

1. Be cautious of the tiny removable components when you use a vacuum cleaner to absorb the dirt on the floor.
2. Turn the system off before you start to clean up the component or computer.
3. Never drop the components inside the computer or get circuit board damp or wet.
4. Be cautious of all kinds of cleaning solvents or chemicals when you use it for the sake of cleaning. Some individuals may be allergic to the ingredients.
5. Try not to put any food, drink or cigarette around the computer.

## **Cleaning Tools:**

Although many companies have created products to help improve the process of cleaning your computer and peripherals users can also use household items to clean their computers and peripherals. Below is a listing of items you may need or want to use while cleaning your computer or computer peripherals.

Keep in mind that some components in your computer may require designated products for cleaning. If this is the case it will be mentioned in the cleaning instructions.

- **Cloth:** A piece of cloth is the best tool to use when rubbing up a component. Although paper towels or tissues can be used on most hardware as well, we still recommend you to rub it with a piece of cloth.
- **Water or rubbing alcohol:** You may moisten a piece of cloth a bit with some water or rubbing alcohol and rub it on the computer. Unknown solvents may be harmful to the plastics parts.
- **Vacuum cleaner:** Vacuuming the dust, dirt, hair, cigarette particles, and other particles out of a computer can be one of the best methods of cleaning a computer. Over time these items can restrict the airflow in a computer and cause circuitry to corrode.
- **Cotton swabs:** Cotton swabs moistened with rubbing alcohol or water are excellent tools for wiping hard to reach areas in your keyboard, mouse, and other locations.
- **Foam swabs:** Whenever possible it is better to use lint free swabs such as foam swabs.



**Note:** *It is strongly recommended that you should shut down the system before you start to clean any single components.*



**Note:** *Please check the temperature of system surface before maintenance.*

## **Please follow the steps below:**

1. Close all application programs;
2. Close operating software;
3. Turn off power switch;
4. Remove all device;
5. Pull out the power cable.

## **Scrap Computer Recycling**

Please inform the nearest Axiomtek distributor as soon as possible for suitable solutions in case computers require maintenance or repair; or for recycling in case computers are out of order or no longer in use.

## **Trademark Acknowledgments**

Axiomtek is a trademark of Axiomtek Co., Ltd.

Intel® and Pentium® are registered trademarks of Intel Corporation.

Windows 10, Windows 10 IoT Enterprise, Windows 7, are trademarks of Microsoft Corporation.

Other brand names and trademarks are the properties and registered brands of their respective owners.

# Table of Contents

---

Safety Precautions .....	iii
Classification .....	iv
General Cleaning Tips .....	iv
Scrap Computer Recycling .....	vi
<b>SECTION 1 INTRODUCTION.....</b>	<b>1</b>
<b>1.1 General Description .....</b>	<b>1</b>
<b>1.2 System Specifications .....</b>	<b>2</b>
1.2.1 Main CPU Board .....	2
1.2.2 I/O System .....	3
<b>1.3 Dimensions .....</b>	<b>7</b>
<b>1.4 I/O Outlets.....</b>	<b>9</b>
<b>1.5 Packing List.....</b>	<b>15</b>
<b>1.6 M/B Block Diagram .....</b>	<b>16</b>
<b>1.7 Jumper Settings.....</b>	<b>17</b>
1.7.1 Restore BIOS Optimal Defaults (JP2) .....	17
1.7.2 DELAY Function SW (JP10&JP11).....	17
<b>1.8 Connectors.....</b>	<b>18</b>
1.8.1 MINI Card Slot (CN4).....	19
1.8.2 LAN+USB3.0 (CN9, CN10).....	20
1.8.3 VGA Connector (CN3) .....	21
1.8.4 USB 2.0 Connector (CN13).....	22
1.8.5 Audio Connector (CN1) .....	22
1.8.6 DC-in Phoenix Power Connector (CN12).....	22
1.8.7 HDMI Connector (CN2) .....	23
1.8.8 COM Port Connector (COM1 ) .....	23
1.8.9 M.2 2280 Key M NVMe SSD (CN8) .....	24
1.8.10 M.2 3042/3050 Key B (CN5).....	25
1.8.11 SATA Power Connector (SCN2).....	26
1.8.12 SATA Connector (SATA1~SATA2) .....	26
1.8.13 Power On/OFF Button (SW2).....	26
1.8.14 AT/ATX Switch (SSW1) .....	27
1.8.15 Remote Power Switch Connector (PWRBT1) .....	27
1.8.16 Flexible IO - COM I/O Card Connector (AX93511) .....	27
1.8.17 Flexible IO – Isolated COM x4 I/O Card (AX93516).....	28
1.8.18 Flexible IO – Isolated COM & DIO I/O Card (AX93512).....	29
1.8.19 Flexible IO- USB3.0x2 & COMx2(RS232/422/485) & LAN(AX93519) .....	31
1.8.20 Riser Card- PCIe x16 Gen3 & 1 PCIe x4 Gen 3(AX96205).....	33
1.8.21 Riser Card- PCIe x16 Gen3 & 1 PCI(AX96206).....	35
1.8.22 Riser Card- 2 PCI (AX96207).....	37
1.8.23 Riser Card- PCIe x16 Gen3 & 3 PCIe x4 Gen 3 (AX96410).....	39
1.8.24 Riser Card- PCIe x16 Gen3 & 1 PCIe x4 Gen 3 & 2 PCI (AX96411) .....	41
<b>SECTION 2 HARDWARE INSTALLATION .....</b>	<b>43</b>
<b>2.1 Installing the Processor .....</b>	<b>43</b>
<b>2.2 Procedure of Installation .....</b>	<b>44</b>
<b>2.3 Installing the Memory Module.....</b>	<b>45</b>
<b>2.4 Installing the Hard Disk Drive .....</b>	<b>46</b>
<b>2.5 Installing the expansion box kit .....</b>	<b>48</b>

2.6	Installing the Fan Module .....	50
2.6.1	Installing Internal Fan Module .....	50
2.6.2	Installing external Fan Module .....	52
2.7	Installing PCI or PCIe Card .....	53
2.7.1	Installing PCI or PCIe card .....	53
2.7.2	The limitation of an add-on card .....	56
2.7.3	Inatalling T4 graphics card w/T4 fan module .....	64
2.8	Installing the Mini Card Module .....	70
2.9	Installing the 5G Wireless Module .....	71
2.10	Installing the NVMe SSD Module .....	74
2.11	Mounting.....	76
<b>SECTION 3 AMI BIOS UTILITY .....</b>		<b>81</b>
3.1	Starting .....	81
3.2	Navigation Keys .....	82
3.3	Main Menu .....	83
3.4	Advanced Menu .....	84
3.5	Chipset Menu .....	99
3.6	Security Menu .....	104
3.7	Boot Menu .....	105
3.8	Save & Exit Menu .....	106
<b>APPENDIX A WATCHDOG TIMER .....</b>		<b>109</b>
A.1	About Watchdog Timer.....	109
A.2	How to Use Watchdog Timer.....	109
<b>APPENDIX B CONFIGURING SATA FOR RAID.....</b>		<b>113</b>



## SECTION 1 INTRODUCTION



This chapter contains general information and detailed specifications of the IPC960-525/IPC962-525/IPC964-525 Series. Chapter 1 includes the following sections:

- General Description
- System Specifications
- Dimensions
- I/O Outlets
- Jumper Settings
- Connectors
- Package List

### 1.1 General Description

The IPC960-525, IPC962-525 and IPC964-525 are fanless systems with an optional fan module that can support LGA1151 socket for Intel® 9th/8th generation Core™ i7/i5/i3 processors. The IPC960-525/IPC962-525/IPC964-525 is also built with a rugged design that makes the system suitable for the most enduring operation.

For operation systems, the IPC960-525/IPC962-525/IPC964-525 series not only supports Windows® 10 and Ubuntu, but also supports embedded OS.

- The IPC960-525/IPC962-525/IPC964-525 Series supports two hard-drive bays to make it easy for customers to install and maintain the system.
- Embedded O.S. supported

## 1.2 System Specifications

### 1.2.1 Main CPU Board

- CPU

- Socket LGA1151 for 9<sup>th</sup> / 8<sup>th</sup> Generation Intel® Core™ i7/i5/i3 processors, up to 65W
- Below is a list of supported CPUs.

Generation	Proc No	WATT	Core	Thread	Base frequency
Coffee Lake-S refresh	i9-9900	65	8	16	3.1 GHz
Coffee Lake-S refresh	i5-9600	65	6	6	3.1 GHz
Coffee Lake-S refresh	i5-9500F	65	6	6	3.0 GHz
Coffee Lake-S refresh	i5-9500E	65	6	6	3.0 GHz
Coffee Lake-S refresh	i5-9500	65	6	6	3.0 GHz
Coffee Lake-S refresh	i5-9400F	65	6	6	2.9 GHz
Coffee Lake-S refresh	i5-9400	65	6	6	2.9 GHz
Coffee Lake-S refresh	i7-9700TE	35	8	8	1.8 GHz
Coffee Lake-S refresh	i7-9700T	35	8	8	2.0 GHz
Coffee Lake-S refresh	i5-9600T	35	6	6	2.3 GHz
Coffee Lake-S refresh	i5-9500TE	35	6	6	2.2 GHz
Coffee Lake-S refresh	i5-9500T	35	6	6	2.2 GHz
Coffee Lake-S refresh	i5-9400T	35	6	6	1.8 GHz
Coffee Lake-S refresh	i3-9100TE	35	4	4	2.2 GHz
Coffee Lake-S refresh	i3-9100T	35	4	4	3.1 GHz
Coffee Lake-S refresh	G4930T	35	2	2	3.0 GHz
Coffee Lake-S	i5-8600	65	6	6	3.1 GHz
Coffee Lake-S	i5-8500	65	6	6	3.0 GHz
Coffee Lake-S	i5-8400	65	6	6	2.8 GHz
Coffee Lake-S	G4900	54	2	2	3.1 GHz
Coffee Lake-S	i7-8700T	35	6	12	2.4 GHz
Coffee Lake-S	i5-8600T	35	6	6	2.3 GHz
Coffee Lake-S	i5-8500T	35	6	6	2.1 GHz
Coffee Lake-S	i5-8400T	35	6	6	1.7 GHz
Coffee Lake-S	i3-8100T	35	4	4	3.1 GHz
Coffee Lake-S	G5400T	35	2	4	3.1 GHz
Coffee Lake-S	G4900T	35	2	2	2.9 GHz

- System Chipset

- Intel® H310 chipset (IPC960-525-H310-DC-FL/IPC962-525-H310-DC-FL)
- Intel® Q370 chipset (IPC960-525-Q370--DC-FL/IPC962-525-Q370-DC-FL-/IPC964-525-Q370-DC-FL)

- **BIOS**
  - AMI BIOS, with Smart View and Customer CMOS Backup.
- **System Memory**
  - Two DDR4-2666/2400 un-buffered SO-DIMM max. up to 64GB
- **System Certification**
  - CE/FCC
- **Features**
  - Compact front IO design
  - Supports PCIe/PCI expansion slots
  - DC to DC power supply support 24VDC (uMin=19V/uMax=30V)
  - Supports two 2.5" HDD bays (7/9.5mm height)
  - Supports RAID 0,1 (for Q370 PCH)
  - Supports TPM2.0
  - Supports optional 5G mobile module (for Q370 PCH) or WLAN module & antennas
  - Supports optional fan module (for IPC962 and IPC964)

## 1.2.2 I/O System

- **Standard I/O Interface -- Front**
    - One ATX power on/off switch w/LED
    - One ATX/AT mode switch
    - One 2-pin connector output for remote power on/off switch
    - DC to DC power supply, which supports 24VDC (uMin=19V/uMax=30V) with phoenix power plug
    - Four USB 3.1 Gen.2 ports (for Q370 PCH) or  
Four USB3.1 Gen.1 ports (for H310 PCH)
    - Two USB 2.0 ports
-  **Note:** *IPC960-525 series support a internal USB2.0 with 180D type A connector for license key, up to 30mm)*
- One HDD/SSD access LED
  - Three user's LEDs
  - Two G.E. LAN ports (i211AT & I219LM)
  - Extension system I/O module:
    - AX93511 4 x RS-232/422/485 module (default RS-232) or
    - AX93512 2 x RS-232/422/485 w/ isolated 1.5KVDC protection and 8-in/8-out isolated 1.5KVDC DIO or
    - AX93516 4 x RS232/422/485 w/isolated 2KVDC module
    - AX93519 2 x RS232/422/485 + 1 G.E. LAN (i211AT) + 2 USB.3.1 (1 USB3.1 Gen.2 signal & 1 USB 2.0 signal) module (for Q370 PCH)



**Note:** The RS-485 auto flow control only supports below formats to communicate data:

- 8 data bits + 1 stop bit
- 8 data bits + 1 parity bit + 1 stop bit
- 8 data bits + 1 parity bit + 2 stop bits
- 8 data bits + 2 stop bits
- 7 data bits + 1 parity bit (even or odd) + 2 stop bits

- One VGA supports resolution up to 1920 x 1200 @60Hz
- One HDMI 1.4b supports resolution up to 4096 x 2160@24MHz
- 1 x Audio (Line-out)

● **Expansion Interface**

**IPC960-525-H310 / IPC960-525-Q370**

- Mini card slot or M.2 Key B socket
  - 1 x on board full-size PCI Express Mini Card slot with USB interface (for H310 PCH)
  - 1 x on board full-size PCI Express Mini Card slot with USB/PCIe interface or
  - 1 x on board M.2 Key B socket (3042/3050) (for Q370 PCH)

**IPC962-525-H310 / IPC962-525-Q370**

- Mini card slot or M.2 Key B socket
  - 1 x on board full-size PCI Express Mini Card slot with USB interface (for H310 PCH)
  - 1 x on board full-size PCI Express Mini Card slot with USB/PCIe interface or
  - 1 x on board M.2 Key B socket (3042/3050) (for Q370 PCH)
- PCIe/PCI slot
  - 1 x AX96205: 1 PCIe x16 + 1 PCIe x4 or
  - 1 x AX96206: 1 PCIe x16 + 1 PCI or
  - 1 x AX96207: 2 PCI

**IPC964-525-Q370**

- Mini Card slot or M.2 Key B socket
  - 1 x on board full-size PCI Express Mini Card slot with USB/PCIe interface or
  - 1 x on board M.2 Key B socket (3042/3050)
- PCIe/PCI slot
  - 1 x AX96410: 1 PCIe x16 + 3 PCIe x4 or
  - 1 x AX96411: 1 PCIe x16 + 1 PCIe x4 + 2PCI



**Note:** The maximum power rating for expansion slots at 60 °C cannot exceed the following value:

*The maximum loading of +3.3V+5V+12V<150W*



**Note:** 12V maximum loading is 12A(144W).



**Note:** The system power rating may thus be changed base on differing combinations of

**attached devices.**

- **Drive Capacity**

- Supports two 2.5" HDD driver bays (SSD/HDD 7 or 9.5mm height)



**Note:** Since Gen. 2 SSD with JMicron controller has a compatibility issue with Intel H310 PCH, it is strongly recommended to use Gen. 3 SSD on the IPC962 Series.

- **Power Input**

- 24VDC (uMin=19V/uMax=30V) with phoenix power plug



**Note:** Please fix the system power input in 24Vdc when plugging an add-on card.

- **Operating Temperature**

Generation	Proc No	WATT	Core	Thread	Operating Temperature	Remark	Base frequency
Coffee Lake-S refresh	i9-9900	65	8	16	-10°C-50°C	*	3.1 GHz
Coffee Lake-S refresh	i5-9600	65	6	6	-10°C-50°C	*	3.1 GHz
Coffee Lake-S refresh	i5-9500F	65	6	6	-10°C-50°C	*	3.0 GHz
Coffee Lake-S refresh	i5-9500E	65	6	6	-10°C-50°C	*	3.0 GHz
Coffee Lake-S refresh	i5-9500	65	6	6	-10°C-50°C	*	3.0 GHz
Coffee Lake-S refresh	i5-9400F	65	6	6	-10°C-50°C	*	2.9 GHz
Coffee Lake-S refresh	i5-9400	65	6	6	-10°C-50°C	*	2.9 GHz
Coffee Lake-S refresh	i7-9700TE	35	8	8	-10°C-60°C	*	1.8 GHz
Coffee Lake-S refresh	i7-9700T	35	8	8	-10°C-60°C	*	2.0 GHz
Coffee Lake-S refresh	i5-9600T	35	6	6	-10°C-60°C	*	2.3 GHz
Coffee Lake-S refresh	i5-9500TE	35	6	6	-10°C-60°C	*	2.2 GHz
Coffee Lake-S refresh	i5-9500T	35	6	6	-10°C-60°C	*	2.2 GHz
Coffee Lake-S refresh	i5-9400T	35	6	6	-10°C-60°C	*	1.8 GHz
Coffee Lake-S refresh	i3-9100TE	35	4	4	-10°C-60°C		2.2 GHz

Coffee Lake-S refresh	i3-9100T	35	4	4	-10°C-60°C		3.1 GHz
Coffee Lake-S refresh	G4930T	35	2	2	-10°C-60°C		3.0 GHz
Coffee Lake-S	i5-8600	65	6	6	-10°C-50°C		3.1 GHz
Coffee Lake-S	i5-8500	65	6	6	-10°C-50°C	*	3.0 GHz
Coffee Lake-S	i5-8400	65	6	6	-10°C-50°C	*	2.8 GHz
Coffee Lake-S	G4900	54	2	2	-10°C-50°C		3.1 GHz
Coffee Lake-S	i7-8700T	35	6	12	-10°C-60°C	*	2.4 GHz
Coffee Lake-S	i5-8600T	35	6	6	-10°C-60°C		2.3 GHz
Coffee Lake-S	i5-8500T	35	6	6	-10°C-60°C		2.1 GHz
Coffee Lake-S	i5-8400T	35	6	6	-10°C-60°C		1.7 GHz
Coffee Lake-S	i3-8100T	35	4	4	-10°C-60°C		3.1 GHz
Coffee Lake-S	G5400T	35	2	4	-10°C-60°C		3.1 GHz
Coffee Lake-S	G4900T	35	2	2	-10°C-60°C		2.9 GHz

\* **The IPC system may cause CPU frequency hopping when operating in an extremely high temperature environment, and thermal throttling may occur when the system remains in full loading conditions.**



**Note: The performance of the system might be adversely affected when operating at a temperature above the system's limitation or with an unrecommended processor.**



**Note: If the operating temperature is above 35°C, it is recommended to use a wide temperature SSD on the device.**

- **Storage Temperature**

- -20°C ~ 80°C

- **Humidity**

- 10% ~ 90% (Non-condensing)

- **Dimensions**

**IPC960-525**

- 83.5 mm (3.28") (W) x 192 mm (7.54") (H) x 230 mm (9.04") (D)

**IPC962-525**

- 147.5 mm (5.81") (W) x 192 mm (7.56") (H) x 230 mm (9.04") (D)

**IPC964-525**

- 188.1 mm (7.39") (W) x 192 mm (7.54") (H) x 230 mm (9.04") (D)



**Note: All specifications and images are subject to change without notice.**

### 1.3 Dimensions

The following diagrams show you dimensions and outlines of the IPC960-525/IPC962-525/IPC964-525 Series.

#### IPC960-525

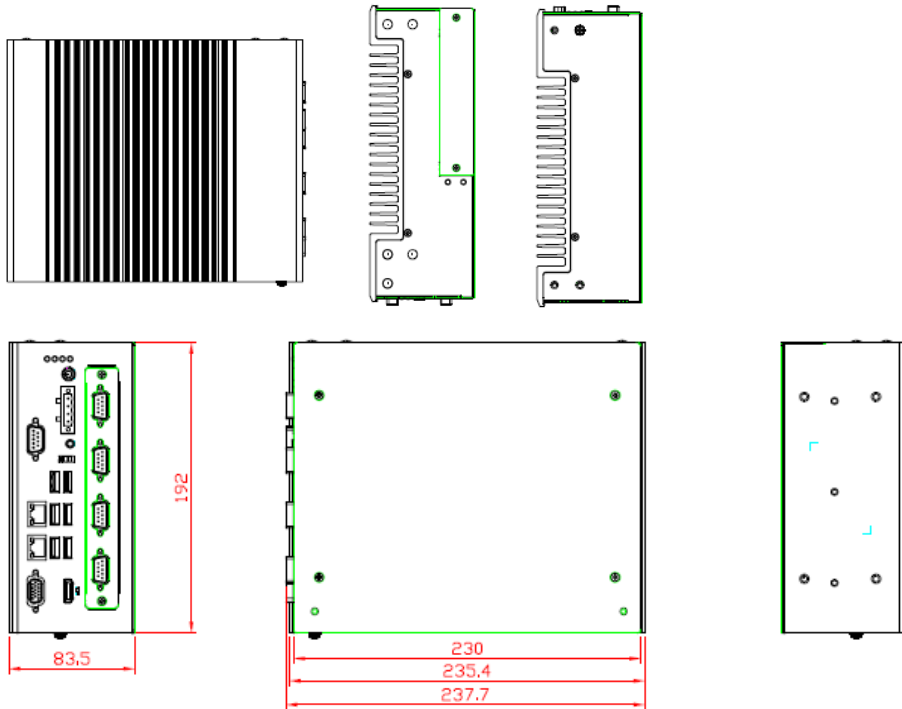

#### IPC962-525

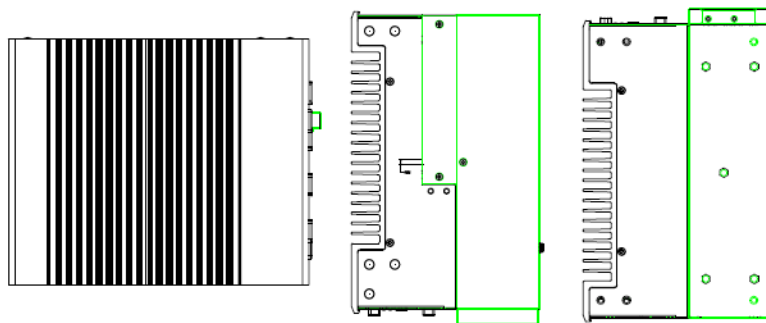

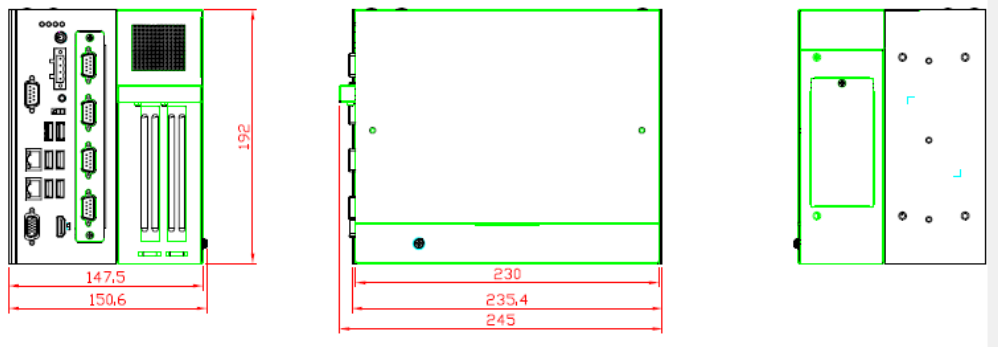

**IPC964-525**

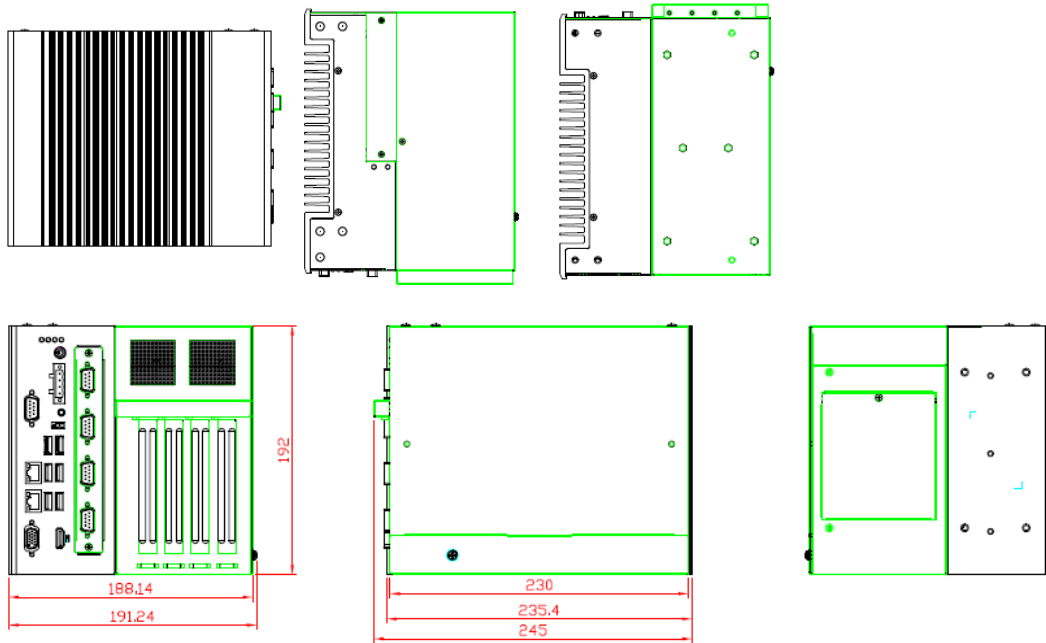



## 1.4 I/O Outlets

The following figures show locations of the IPC900 series I/O outlets

### IPC960-525 Front Panel

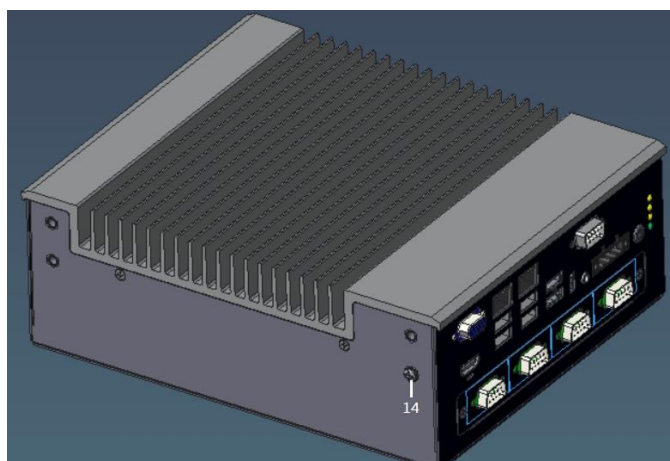

Mark	Description
1	1 x HDD/SSD access LED 3 x User's LED
2	1 x 4-pin terminal block
3	1 x RS-232/422/485 (default RS-232)
4	2 x LAN
5	1 x VGA
6	1 x HDMI
7	1 x Switch for power on/off w/LED

8	Extension system I/O module
9	1 x Line out
10	1 x Remote switch
11	2 x USB2.0
12	4 x USB 3.1
13	1 x AT/ATX switch (default ATX)
14	1 x Terminal ground

**IPC962-525 Front Panel**

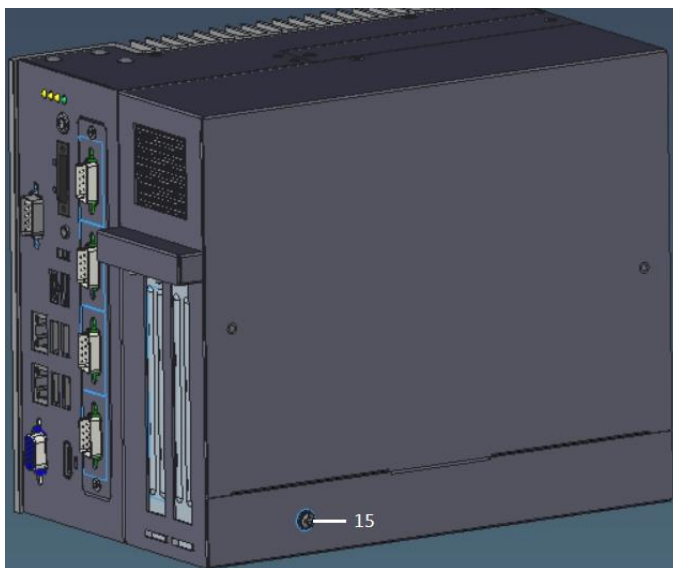
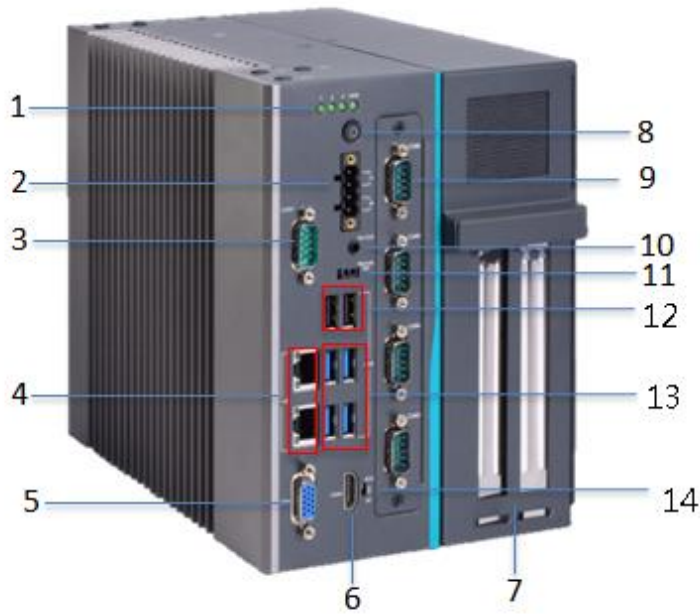

Mark	Description
1	1 x HDD/SSD access LED 3 x User's LED
2	1 x 4-pin terminal block
3	1 x RS-232/422/485 (default RS-232)
4	2 x LAN
5	1 x VGA
6	1 x HDMI

7	Riser (PCIe/PCI slots expansion)
8	1 x Switch for power on/off w/LED
9	Extension system I/O module
10	1 x Line out
11	1 x Remote switch
12	2 x USB2.0
13	4 x USB 3.1
14	1 x AT/ATX switch (default ATX)
15	1 x Terminal ground

**IPC964-525 Front Panel**

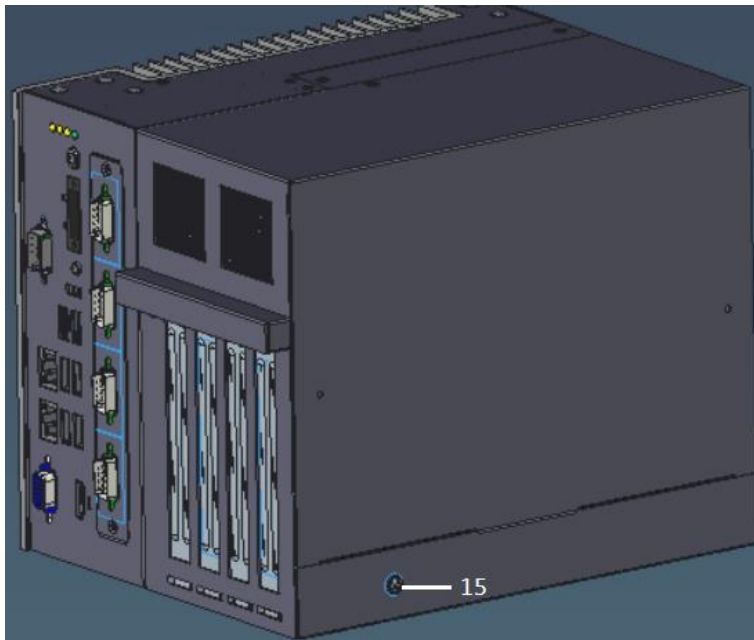

Mark	Description
1	1 x HDD/SSD access LED 3 x User's LED
2	1 x 4-pin terminal block
3	1 x RS-232/422/485 (default RS-232)
4	2 x LAN
5	1 x VGA

6	1 x HDMI
7	Riser (PCIe/PCI slots expansion)
8	1 x Switch for power on/off w/LED
9	Extension system I/O module
10	1 x Line out
11	1 x Remote switch
12	2 x USB2.0
13	4 x USB 3.1
14	1 x AT/ATX switch (default ATX)
15	1 x Terminal ground

## 1.5 Packing List

The package bundled with your IPC960-525/IPC962-525/IPC964-525 Series should contain the following items:

- IPC960-525/IPC962-525/IPC964-525 Series unit x 1
- Screw pack x 1
- Foot pad x 4
- CPU grease x 1
- Terminal block x 1
- Remote switch cable x 1
- Holder bracket kit x1 (for IPC962/IPC964)
- HDD spacer x1 (for 7mm height SSD/HDD)

If you cannot find this package or any items are missing, please contact Axiomtek distributors immediately.

## 1.6 M/B Block Diagram

The following diagram shows you the M/B block diagram of SBC87525.

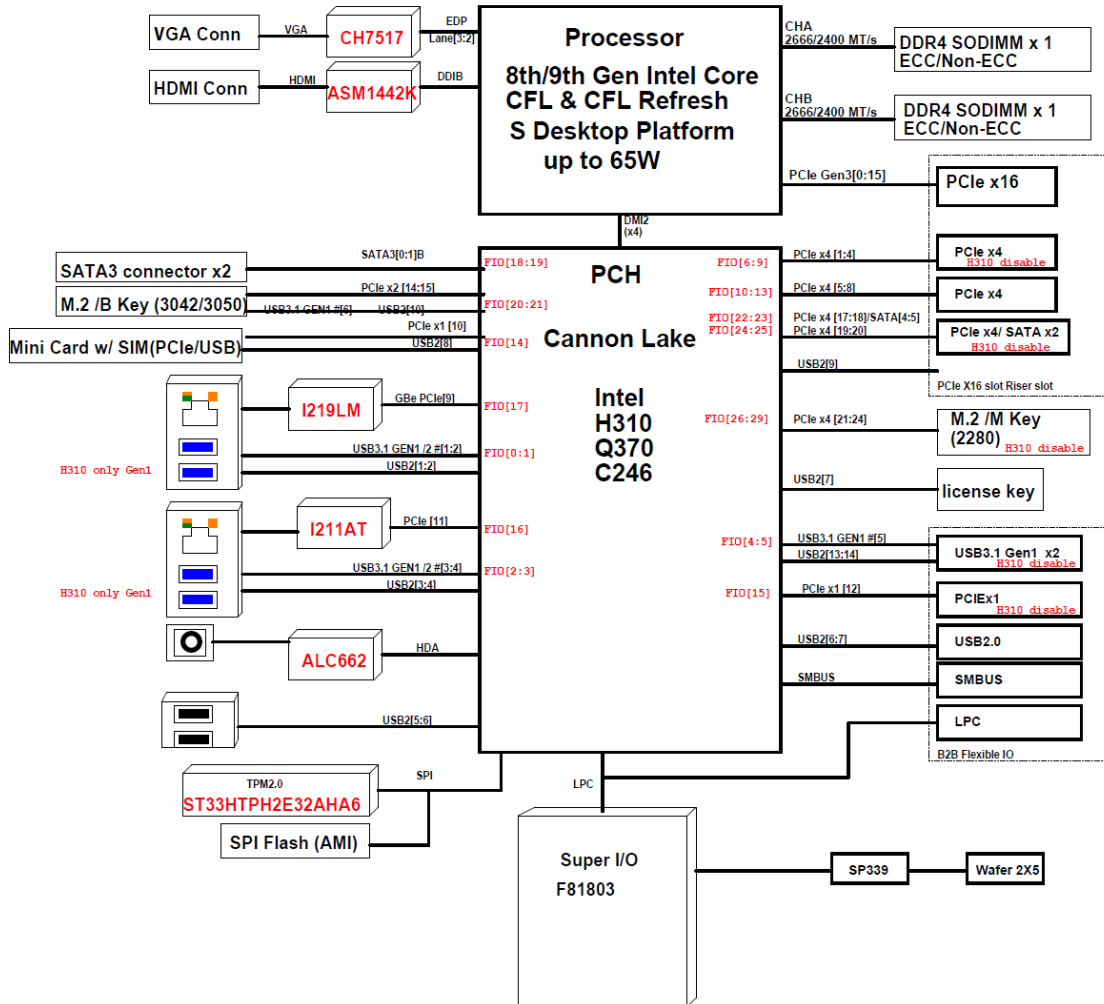



## 1.7 Jumper Settings

Properly configure jumper settings on the SBC87525 to meet your application purpose. Below you can find a summary table of all jumpers and onboard default settings.



**Note: How to setup Jumpers**

Illustrations below show that a cap on a jumper is to “close” the jumper, whereas that off a jumper is to “open” the jumper.

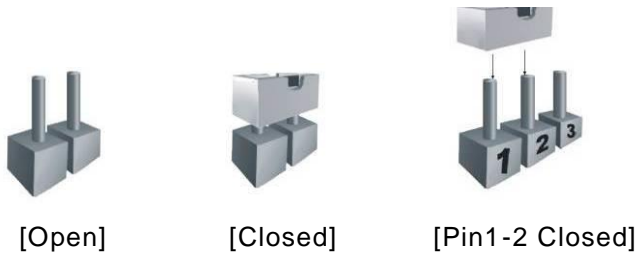

Jumper	Descriptions	Setting
JP2	Clear RTC : Normal	Short 1-2
JP10&JP11	DELAY Function SW	Short 1-2

### 1.7.1 Restore BIOS Optimal Defaults (JP2)

Put jumper clip to pin 2-3 for a few seconds then move it back to pin 1-2. Doing this procedure can restore BIOS optimal defaults.

Function	Setting
Normal operation (Default)	1-2 close
Restore BIOS optimal defaults	2-3 close

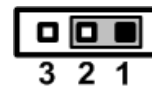

### 1.7.2 DELAY Function SW (JP10&JP11)

JP11	JP10	function
2-3 close	2-3 close	delay 3s power on
2-3 close	1-2 close	delay 6s power on
1-2 close	1-2 close	disable delay function (default)

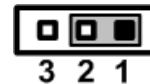

## 1.8 Connectors

Connectors connect the board with other parts of the system. Loose or improper connection might cause problems. Make sure all connectors are properly and firmly connected.

Here is a table summarizing all connectors on the board.

Connector	Label
MINI Card slot	CN4
LAN1+USB3.0	CN9
LAN2+USB3.0	CN10
VGA connector	CN3
USB 2.0 connector	CN13
Audio connector	CN1
DC-in Phoenix power connector	CN12
HDMI connector	CN2
M.2 2280 Key M NVMe SSD	CN8
M.2 3042/3050 Key B	CN5
COM port connector	COM1
SATA Power connector	SCN2
SATA III connector	SATA1~2
DDR4 SO-DIMM (260 Pin)	SDIMM1 SDIMM2
Power button	SW2
AT/ATX Power select	SW3
Remote SW	PWRBT1
Flexible IO-AX93511 COM x4 (RS232/422/485)	SCN1
Flexible IO-AX93516 isolated COM x4 (RS232/422/485)	
Flexible IO-AX93512 isolated COM x2 (RS232/422/485) & 8in/8out DIO	
Flexible IO-AX93519 COM x2 (RS232/422/485), USB3.0 x2 & LAN1	
Riser Card-AX96205 PCIe x16 Gen3 & 1 PCIe x4 Gen 3	SHB1+SHB2
Riser Card-AX96206 PCIe x16 Gen3 & 1 PCI	
Riser Card-AX96207 2 PCI	
Riser Card –AX96410 PCIe x16 Gen3 & 3 PCIe x4 Gen 3	
Riser Card –AX96411 PCIe x16 Gen3 & 1 PCIe x4 Gen 3 & 2 PCI	

### 1.8.1 MINI Card Slot (CN4)

A PCI-Express Mini Card connector is located on the top side . It follows mini PCIe 1.2 standard.

Pins	Signals	Pins	Signals
1	WAKE#	2	+3.3VSB
3	No use	4	GND
5	No use	6	+1.5V
7	CLKREQ#	8	No use
9	GND	10	No use
11	REFCLK-	12	No use
13	REFCLK+	14	No use
15	GND	16	No use
17	No use	18	GND
19	No use	20	W_DISABLE#
21	GND	22	PERST#
23	PE_RXN3/	24	+3.3VSB
25	PE_RXP3/	26	GND
27	GND	28	+1.5V
29	GND	30	SMB_CLK
31	PE_TXN3/	32	SMB_DATA
33	PE_TXP3/	34	GND
35	GND	36	USB_D8-
37	GND	38	USB_D8+
39	+3.3VSB	40	GND
41	+3.3VSB	42	No use
43	GND	44	No use
45	No use	46	No use
47	No use	48	+1.5V
49	No use	50	GND
51	No use	52	+3.3VSB

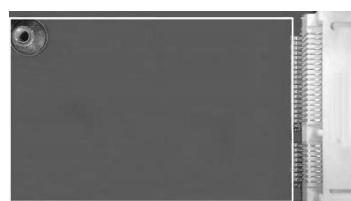
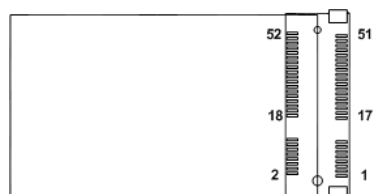

**Note:** For H310 PCH, the on board full-size PCI Express Mini Card slot offers USB interface.  
For Q370 PCH, the on board full-size PCI Express Mini Card slot offers PCIe and USB interface.

### 1.8.2 LAN+USB3.0 (CN9, CN10)

The system has two RJ-45 connectors: LAN1 and LAN2. Ethernet connection can be established by plugging one end of the Ethernet cable into this RJ-45 connector and the other end (phone jack) to a 1000/100/10-Base-T hub.

Pins	1000 Base-T	100/10 Base-T	Descriptions
L1	BI_DA+	TX+	Bidirectional or Transmit Data+
L2	BI_DA-	TX-	Bidirectional or Transmit Data-
L3	BI_DB+	RX+	Bidirectional or Receive Data+
L4	BI_DC+	N.C.	Bidirectional or Not Connected
L5	BI_DC-	N.C.	Bidirectional or Not Connected
L6	BI_DB-	RX-	Bidirectional or Receive Data-
L7	BI_DD+	N.C.	Bidirectional or Not Connected
L8	BI_DD-	N.C.	Bidirectional or Not Connected
A	Active Link LED (Yellow) Off: No link Blinking: Data activity detected		
B	Speed LED 1000: Orange 100: Green 10: OFF		

The Universal Serial Bus connectors are compliant with USB 3.0 (10Gb/s) and ideal for installing USB peripherals such as scanners, cameras and USB devices.

Pins	Signal USB Port 0	Pins	Signal USB Port 1
1	USB_VCC (+5V level standby power)	10	USB_VCC (+5V level standby power)
2	USB_Data2-	11	USB_Data3-
3	USB_Data2+	12	USB_Data3+
4	GND	13	GND
5	SSRX2-	14	SSRX3-
6	SSRX2+	15	SSRX3+
7	GND	16	GND
8	SSTX2-	17	SSTX3-
9	SSTX2+	18	SSTX3+

### 1.8.3 VGA Connector (CN3)

The CN9 is a 15-pin D-Sub connector which is commonly used for connecting a CRT monitor.

Pins	Signals	Pins	Signals
1	Red	2	Green
3	Blue	4	N.C.
5	GND	6	DETECT
7	GND	8	GND
9	+5V	10	GND
11	N.C.	12	DDC DATA
13	Horizontal Sync	14	Vertical Sync
15	DDC CLK		

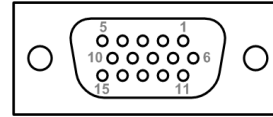

### 1.8.4 USB 2.0 Connector (CN13)

The Universal Serial Bus connectors are compliant with USB 2.0 (480Mbps), providing ideal interfaces ideal for installing USB peripherals such as a keyboard, mouse, scanner, etc.

Pin	Signal USB Port 0	Pin	Signal USB Port 1
1	USB VCC (+5V level)	5	USB VCC (+5V level)
2	USB #0_D-	6	USB #1_D-
3	USB #0_D+	7	USB #1_D+
4	Ground (GND)	8	Ground (GND)

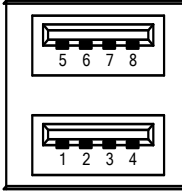

### 1.8.5 Audio Connector (CN1)

These two audio jacks are ideal for Audio Mic-In and Audio Line-out.

Pins	Signals
1	Line Out



### 1.8.6 DC-in Phoenix Power Connector (CN12)

The system supports the 24VDC (uMin=19V/uMax=30V) Phoenix DC-in connector for system power input.

Pins	Signals
1	DC+
2	DC+
3	DC-
4	DC-

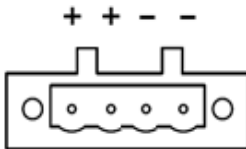

### 1.8.7 HDMI Connector (CN2)

The HDMI (High-Definition Multimedia Interface) is a compact digital interface which is capable of transmitting high-definition video and high-resolution audio over a single cable.

Pins	Signals	Pins	Signals
1	HDMI OUT_DATA2+	11	GND
2	GND	12	HDMI OUT Clock-
3	HDMI OUT_DATA2-	13	N.C.
4	HDMI OUT_DATA1+	14	N.C.
5	GND	15	HDMI OUT_SCL
6	HDMI OUT_DATA1-	16	HDMI OUT_SDA
7	HDMI OUT_DATA0+	17	GND
8	GND	18	+5V
9	HDMI OUT_DATA0-	19	HDMI_HTPLG
10	HDMI OUT Clock+		

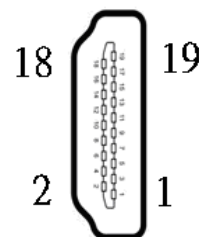

### 1.8.8 COM Port Connector (COM1)

The system has a serial port: COM1 is RS-232/422/485 port. Please set configuration of the serial port in the Advanced menu in BIOS.

Pins	RS-232	RS-422	RS-485
	Detect	TX-	Data-
		TX+	Data+
		RX+	No use
4	DTR, Data Terminal Ready	RX-	No use
5	GND, Ground	No use	No use
6	DSR, Data Set Ready	No use	No use
7	RTS, Request To Send	No use	No use
8	CTS, Clear To Send	No use	No use
9	RI, Ring Indicator	No use	No use

### 1.8.9 M.2 2280 Key M NVMe SSD (CN8)

The M.2 2280 Key M NVMe Express SSD for storage.

Pin	Signal	Pin	Signal	Pin	Signal	Pin	Signal
1	GND	2	+3.3V	3	GND	4	+3.3V
5	PERn3	6	NC	7	PERp3	8	NC
9	GND	10	LED_1#	11	PETn3	12	+3.3V
13	PETp3	14	+3.3V	15	GND	16	+3.3V
17	PERn2	18	+3.3V	19	PERp2	20	NC
21	GND	22	NC	23	PETn2	24	NC
25	PETp2	26	NC	27	GND	28	NC
29	PERn1	30	NC	31	PERp1	32	NC
33	GND	34	NC	35	PETn1	36	NC
37	PETp1	38	NC	39	GND	40	NC
41	PERn0	42	NC	43	PERp0	44	NC
45	GND	46	NC	47	PETn0	48	NC
49	PETp0	50	PERST#	51	GND	52	CLKREQ#
53	REFCLKn	54	PEWAKE#	55	REFCLKp	56	NC
57	GND	58	NC	59	CONNECTOR Key M	60	CONNECTOR Key M
61	CONNECTOR Key M	62	CONNECTOR Key M	63	CONNECTOR Key M	64	CONNECTOR Key M
65	CONNECTOR Key M	66	CONNECTOR Key M	67	NC	68	NC
69	NC	70	+3.3V	71	GND	72	+3.3V
73	GND	74	+3.3V	75	GND		

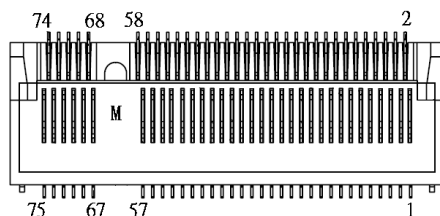



## 1.8.10 M.2 3042/3050 Key B (CN5)

Pin	Signal	Pin	Signal	Pin	Signal	Pin	Signal
1	CONFIG_3	2	+3.3V	3	GND	4	+3.3V
5	GND	6	Full Card PWR OFF	7	USB_D+	8	W_DISABLE1#
9	USB_D-	10	GPIO_9	11	GND	12	Key B
13	Key B	14	Key B	15	Key B	16	Key B
17	Key B	18	Key B	19	Key B	20	GPIO_5
21	CONFIG_0	22	GPIO_6	23	GPIO_11	24	GPIO_7
25	DPR	26	GPIO_10	27	GND	28	GPIO_8
29	USB3.1-Tx-	30	UIM-RESET	31	USB3.1-Tx+	32	UIM-CLK (O)
33	GND	34	UIM-DATA (I/O)	35	USB3.1-Rx-	36	UIM-PWR (O)
37	USB3.1-Rx+	38	NC	39	GND	40	GPIO_0
41	PERn0	42	GPIO_1	43	PERp0	44	GPIO_2
45	GND	46	GPIO_3	47	PETn0	48	GPIO_4
49	PETp0	50	PERST#	51	GND	52	CLKREQ#
53	REFCLKn	54	PEWAKE#	55	REFCLKp	56	NC
57	GND	58	NC	59	ANTCTL0	60	COEX3
61	ANTCTL1	62	COEX_RXD	63	ANTCTL2	64	COEX_TXD
65	ANTCTL3	66	SIM_DETECT	67	RESET# (I)(0/1.8V)	68	SUSCLK
69	CONFIG_1	70	+3.3V	71	GND	72	+3.3V
73	GND	74	+3.3V	75	CONFIG_2		

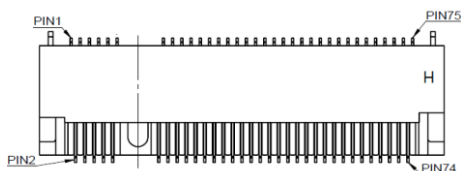

### 1.8.11 SATA Power Connector (SCN2)

The SATA power connector is used for interfacing SATA 2.5" HDD/SSD power supply.

Pins	Signals
1	+12V level
2	GND
3	GND
4	+5V level

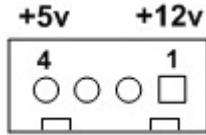

### 1.8.12 SATA Connector (SATA1~SATA2)

These Serial Advanced Technology Attachment (Serial ATA or SATA) connectors are used as high-speed SATA interfaces. They are computer bus interfaces for connecting to devices such as hard disk drives. This board has two SATA 3.0 ports with 6Gb/s performance.

Pins	Signals
1	GND
2	SATA_TX+
3	SATA_TX-
4	GND
5	SATA_RX-
6	SATA_RX+
7	GND

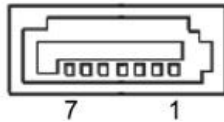

### 1.8.13 Power On/OFF Button (SW2)

The power button is on the I/O side. It allows users to control SBC87525 power on/off.

Function	Description
On	Turn on/off system
Off	Keep system status



### 1.8.14 AT/ATX Switch (SSW1)

If you set AT/ATX switch to AT mode, the system will be automatically powered on without pressing the soft power button during power input; we can use this switch to achieve auto power on demand.



### 1.8.15 Remote Power Switch Connector (PWRBT1)

The system has one 2-pin connector output for remote power on/off switch.

Function	Description
Short(1-2)	Turn on/off system
Open	Keep system status

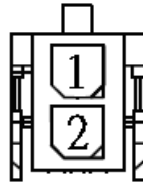

### 1.8.16 Flexible IO - COM I/O Card Connector (AX93511)

The system has an optional four serial port module. COM2~COM5 are RS-232/422/485 ports. Please refer to Chapter 3 for the details of BIOS setting.

※COM2,COM3,COM4,COM5

Pins	RS-232	RS-422	RS-485
1	DCD, Data Carrier Detect	TX-	Data-
2	RXD, Receive Data	TX+	Data+
3	TXD, Transmit Data	RX+	No use
4	DTR, Data Terminal Ready	RX-	No use
5	GND, Ground	No use	No use
6	DSR, Data Set Ready	No use	No use
7	RTS, Request To Send	No use	No use
8	CTS, Clear To Send	No use	No use
9	RI, Ring Indicator	No use	No use

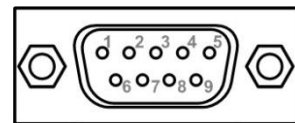

### 1.8.17 Flexible IO – Isolated COM x4 I/O Card (AX93516)

The system has an optional four serial ports module. COM2~COM5 are RS-232/422/485 w/isolated 2KV ports. Please refer to Chapter 4 for the details of BIOS setting.

※COM2,COM3,COM4,COM5

Pins	RS-232	RS-422	RS-485
1	DCD, Data Carrier Detect	TX-	Data-
2	RXD, Receive Data	TX+	Data+
3	TXD, Transmit Data	RX+	No use
4	DTR, Data Terminal Ready	RX-	No use
5	GND, Ground	No use	No use
6	DSR, Data Set Ready	No use	No use
7	RTS, Request To Send	No use	No use
8	CTS, Clear To Send	No use	No use
9	RI, Ring Indicator	No use	No use
10	GND_EARTH	No use	No use

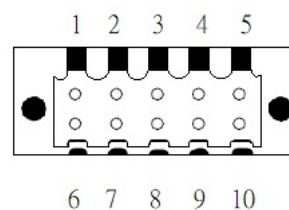

### 1.8.18 Flexible IO – Isolated COM & DIO I/O Card (AX93512)

The system has an optional module to support COM2~COM3, which are RS-232/422/485 with isolated 1.5KVDC protection and DIO1~DIO2 8-in/8-out isolated 1.5KVDC DIO ports. Please refer to Chapter 4 for the details of BIOS setting.

※COM2,COM3,DIO1,DIO2

CN1 (COM2)& CN2(COM3)			
Pins	RS-232	RS-422	RS-485
1	DCD, Data Carrier Detect	TX-	Data-
2	RXD, Receive Data	TX+	Data+
3	TXD, Transmit Data	RX+	No use
4	DTR, Data Terminal Ready	RX-	No use
5	GND, Ground	No use	No use
6	DSR, Data Set Ready	No use	No use
7	RTS, Request To Send	No use	No use
8	CTS, Clear To Send	No use	No use
9	RI, Ring Indicator	No use	No use
10	GND_EARTH	No use	No use

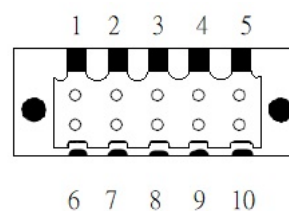

CN3(DIO1)		CN4(DIO2)	
Pin	Function	Pin	Function
1	Common1 PWR+	1	Common2 PWR+
2	DO10	2	DO20
3	DO11	3	DO21
4	DO12	4	DO22
5	DO13	5	DO23
6	Common1 PWR-	6	Common2 PWR-
7	External1 Power	7	External2 Power
8	DI10	8	DI20
9	DI11	9	DI21
10	DI12	10	DI22
11	DI13	11	DI23
12	Isolation1 GND	12	Isolation2 GND

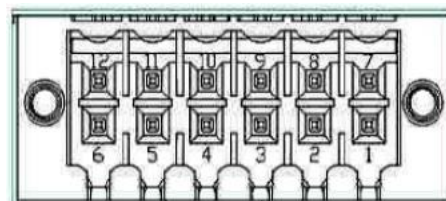

## Digital I/O Specification (per port)

- **Isolated Digital Input**

The figure shows how to connect between external input source and the system.

Each of the isolated digital input channels accepts 0~30 VDC with sink type and source type.

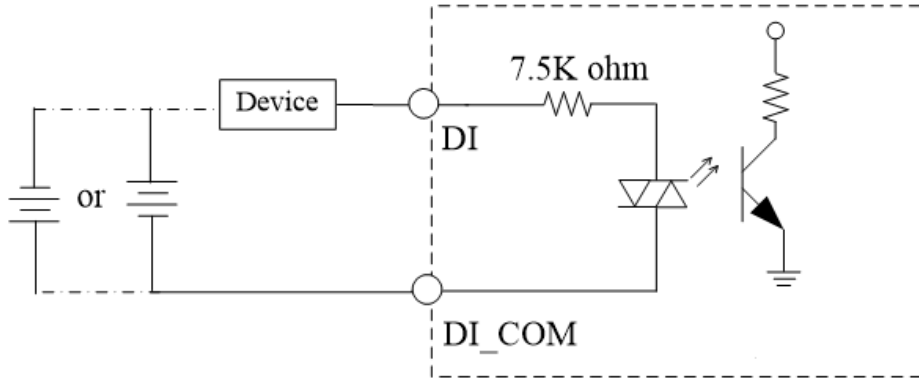

- **Isolated Digital Output**

The figure shows how to connect between an output channel and the system.

If an external voltage 5~30 VDC is applied to an isolated output channel, the current will flow from the external voltage source to the system.

Please note that the current through each DO channel should not exceed 200 mA.

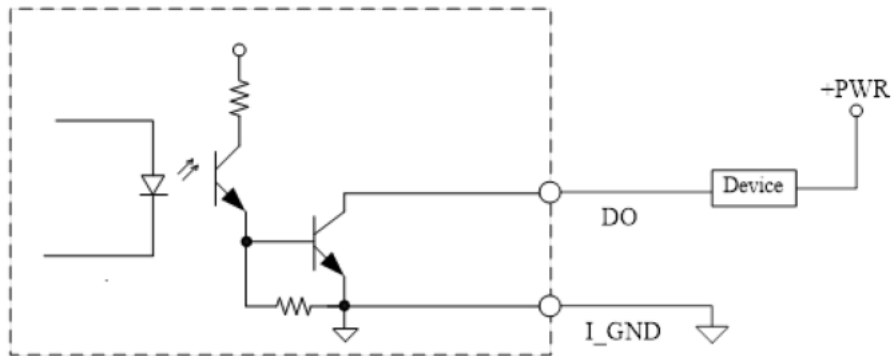

### 1.8.19 Flexible IO- USB3.0x2 & COMx2(RS232/422/485) & LAN(AX93519)

The system has an optional module to support two USB, two RS232/422/485 & one LAN. Please refer to Chapter 4 for the details of BIOS setting.

- AX93519 2 x RS232/422/485 + 1 G.E. LAN(i211AT) + 2 USB.3.1(1 USB3.1 Gen.2 signal & 1 USB 2.0 signal) (for Q370 PCH)

Pins	Signal USB Port 0	Pins	Signal USB Port 1
1	USB_VCC (+5V level standby power)	1	USB_VCC (+5V level standby power)
2	USB_Data2-	2	USB_Data3-
3	USB_Data2+	3	USB_Data3+
4	GND	4	GND
5	SSRX2-	5	SSRX3-
6	SSRX2+	6	SSRX3+
7	GND	7	GND
8	SSTX2-	8	SSTX3-
9	SSTX2+	9	SSTX3+

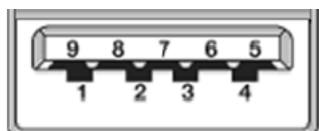

The system has two serial ports. COM2~COM3 are RS-232/422/485 ports. Please refer to Chapter 3 for the detail of BIOS setting.

※COM2,COM3

Pins	RS-232	RS-422	RS-485
1	DCD, Data Carrier Detect	TX-	Data-
2	RXD, Receive Data	TX+	Data+
3	TXD, Transmit Data	RX+	No use
4	DTR, Data Terminal Ready	RX-	No use
5	GND, Ground	No use	No use
6	DSR, Data Set Ready	No use	No use
7	RTS, Request To Send	No use	No use
8	CTS, Clear To Send	No use	No use
9	RI, Ring Indicator	No use	No use

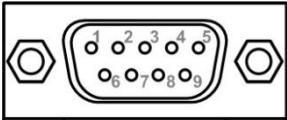

The system has two RJ-45 connectors: LAN Ethernet connection can be established by plugging one end of the Ethernet cable into this RJ-45 connector and the other end (phone jack) to a 1000/100/10-Base-T hub.

Pins	1000 Base-T	100/10 Base-T	Descriptions
L1	BI_DA+	TX+	Bidirectional or Transmit Data+
L2	BI_DA-	TX-	Bidirectional or Transmit Data-
L3	BI_DB+	RX+	Bidirectional or Receive Data+
L4	BI_DC+	N.C.	Bidirectional or Not Connected
L5	BI_DC-	N.C.	Bidirectional or Not Connected
L6	BI_DB-	RX-	Bidirectional or Receive Data-
L7	BI_DD+	N.C.	Bidirectional or Not Connected
L8	BI_DD-	N.C.	Bidirectional or Not Connected
A	Active Link LED (Yellow) Off: No link Blinking: Data activity detected		
B	Speed LED 1000: Orange 100: Green 10: OFF		

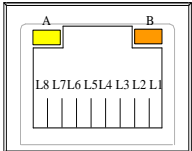



## 1.8.20 Riser Card- PCIe x16 Gen3 & 1 PCIe x4 Gen 3(AX96205)

### Specification

- 1 PCIe x16 Gen3 + 1 PCIe x4 Gen3
- 1 x on board USB2.0 wafer
- 1 x system fan connectors
- 1 x 24V power connector (black, ATX1, for Axiomtek's device only)
- 1 x 12V power connector (white, ATX2, for Axiomtek's device only)



**Note:** Please refer to chapter 1.2.2 for the maximum power rating limitation of expansion slots.

### Internal USB Wafer connector (CN1)

These are 5x1-Pin P=2.0mm headers for USB 2.0 interface.

Pins	Signals
1	+5V_DUAL
2	USB-
3	USB+
4	GND
5	GND

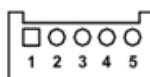

### Fan Connectors (FAN1~FAN2)

This motherboard has three fan connectors. Find fan speed option(s) at BIOS Setup Utility: Advanced\HW Monitor\PC Health Status.

The FAN1~2 (4x1-Pin P=2.54mm) is for the CPU fan connector.

Pins	Signals
1	GND
2	+12V
3	FAN Speed Detection
4	FAN Speed Control



### Expansion Power Input Connectors (ATX1 And ATX2)

This ATX2 connector is for slot card use. (White color)

Pins	Signals
1	GND
2	GND
3	+12V
4	+12V

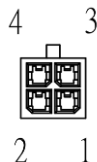

※ ATX1 is reserved for Axiomtek's device use only.

### Temperature Sensor Source Select (JP1)

Use these jumpers (3x1-Pin P=2.54mm) to set temperature sensor source to operate from external or onboard mode.

Onboard Sensor (Default) 1-2 close

Function	Setting
1	On Board Thermistor
2	GND
3	Reserved



※ Pin 3 is reserved for Axiomtek's device use only.

## 1.8.21 Riser Card- PCIe x16 Gen3 & 1 PCI(AX96206)

### Specification

- 1 PCIe x16 Gen3 + 1 PCI
- 1 x on board USB2.0 wafer
- 1 x system fan connectors
- 1 x 24V power connector (black, ATX1, for Axiomtek's device only)
- 1 x 12V power connector (white, ATX2, for Axiomtek's device only)



**Note:** Please refer to chapter 1.2.2 for the maximum power rating limitation of expansion slots.

### Internal USB Wafer connector (CN1)

These are 5x1-Pin P=2.0mm headers for USB 2.0 interface.

Pins	Signals
1	+5V_DUAL
2	USB-
3	USB+
4	GND
5	GND

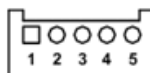

### Fan Connectors (FAN1~FAN2)

This motherboard has three fan connectors. Find fan speed option(s) at BIOS Setup Utility: Advanced\HW Monitor\PC Health Status.

FAN1~2 (4x1-Pin P=2.54mm) is for the CPU fan connector.

Pins	Signals
1	GND
2	+12V
3	Fan Speed Detection
4	Fan Speed Control



### Expansion Power Input Connectors (ATX1 And ATX2)

This ATX2 connector is for slot card use. (White color)

Pins	Signals
1	GND
2	GND
3	+12V
4	+12V

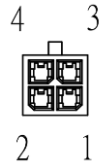

※ ATX1 is reserved for Axiomtek's device use only

### Temperature Sensor Source Select (JP1)

Use these jumpers (3x1-Pin P=2.54mm) to set temperature sensor source to operate from external or onboard mode.

Onboard Sensor (Default) 1-2 close

Function	Setting
1	On Board Thermistor
2	GND
3	Reserved



※ Pin 3 is reserved for Axiomtek's device use only.

## 1.8.22 Riser Card- 2 PCI (AX96207)

### Specification

- 2 PCI
- 1 x on board USB2.0 wafer
- 1 x system fan connectors
- 1 x 24V power connector (black, ATX1, for Axiomtek's device only)
- 1 x 12V power connector (white, ATX2, for Axiomtek's device only)



**Note:** Please refer to chapter 1.2.2 for the maximum power rating limitation of expansion slots.

### Internal USB Wafer connector (CN1)

These are 5x1-Pin P=2.0mm headers for USB 2.0 interface.

Pins	Signals
1	+5V_DUAL
2	USB-
3	USB+
4	GND
5	GND

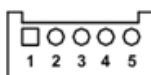

### Fan Connectors (FAN1~FAN2)

This motherboard has three fan connectors. Find fan speed option(s) at BIOS Setup Utility: Advanced\HW Monitor\PC Health Status.

The FAN1~2 (4x1-Pin P=2.54mm) is for the CPU fan connector.

Pins	Signals
1	GND
2	+12V
3	Fan Speed Detection
4	Fan Speed Control



### Expansion Power Input Connectors (ATX1 And ATX2)

This ATX2 connector for slot card use. (White color)

Pins	Signals
1	GND
2	GND
3	+12V
4	+12V

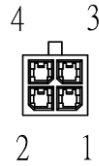

※ ATX1 is reserved for Axiomtek's device use only

### Temperature Sensor Source Select (JP1)

Use these jumpers (3x1-Pin P=2.54mm) to set temperature sensor source to operate from external or onboard mode.

Onboard Sensor (Default) 1-2 close

Function	Setting
1	On Board Thermistor
2	GND
3	Reserved



※ Pin 3 is reserved for Axiomtek's device use only

## 1.8.23 Riser Card- PCIe x16 Gen3 & 3 PCIe x4 Gen 3 (AX96410)

### Specification

- 1 PCIe x16 Gen3 + 3 PCIe x4 Gen3
- 1 x on board USB2.0 wafer
- 1 x system fan connectors
- 1 x 24V power connector (black, ATX1, for Axiomtek's device only)
- 1 x 12V power connector (white, ATX2, for Axiomtek's device only)



**Note:** Please refer to chapter 1.2.2 for the maximum power rating limitation of expansion slots.

### Internal USB Wafer connector (CN1)

These are 5x1-Pin P=2.0mm headers for USB 2.0 interface.

Pins	Signals
1	+5V_DUAL
2	USB-
3	USB+
4	GND
5	GND

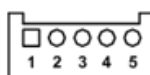

### Fan Connectors (FAN1~FAN2)

This motherboard has two fan connectors. Find fan speed option(s) at BIOS Setup Utility: Advanced\HW Monitor\PC Health Status.

The FAN1~2 (4x1-Pin P=2.54mm) is for the system fan connectors.

Pins	Signals
1	GND
2	+12V
3	Fan Speed Detection
4	Fan Speed Control



### Expansion Power Input Connectors (ATX1 And ATX2)

This ATX2 connector for slot card use. (White color)

Pins	Signals
1	GND
2	GND
3	+12V
4	+12V

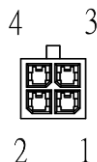

※ ATX1 is reserved for Axiomtek's device use only.

### Temperature Sensor Source Select (JP1)

Use these jumpers (3x1-Pin P=2.54mm) to set temperature sensor source to operate from external or onboard mode.

Onboard Sensor (Default) 1-2 close

Function	Setting
1	On Board Thermistor
2	GND
3	Reserved



※ Pin 3 is reserved for Axiomtek's device use only.



## 1.8.24 Riser Card- PCIe x16 Gen3 & 1 PCIe x4 Gen 3 & 2 PCI (AX96411)

### Specification

- 1 PCIe x16 Gen3 + 1 PCIe x4 Gen3 + 2 PCI
- 1 x on board USB2.0 wafer
- 1 x system fan connectors
- 1 x 24V power connector (black, ATX1, for Axiomtek's device only)
- 1 x 12V power connector (white, ATX2, for Axiomtek's device only)



**Note:** Please refer to chapter 1.2.2 for the maximum power rating limitation of expansion slots.

### Internal USB Wafer connector (CN1)

These are 5x1-Pin P=2.0mm headers for USB 2.0 interface.

Pins	Signals
1	+5V_DUAL
2	USB-
3	USB+
4	GND
5	GND

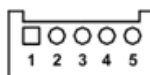

### Fan Connectors (FAN1~FAN2)

This motherboard has two fan connectors. Find fan speed option(s) at BIOS Setup Utility: Advanced\HW Monitor\PC Health Status.

The FAN1~2 (4x1-Pin P=2.54mm) is for the system fan connectors.

Pins	Signals
1	GND
2	+12V
3	Fan Speed Detection
4	Fan Speed Control



## Expansion Power Input Connectors (ATX1 And ATX2)

This ATX2 connector is for slot card use (white color).

Pins	Signals
1	GND
2	GND
3	+12V
4	+12V



※ ATX1 is reserved for Axiomtek's device use only.

### Temperature Sensor Source Select (JP1)

Use these jumpers (3x1-Pin P=2.54mm) to set temperature sensor source to operate from external or onboard mode.

Onboard Sensor (Default) 1-2 close

Function	Setting
1	On Board Thermistor
2	GND
3	Reserved



※ Pin 3 is reserved for Axiomtek's device use only.

## SECTION 2 HARDWARE INSTALLATION

The IPC960-525/IPC962-525/IPC964-525 Series products are convenient for your various hardware configurations, such as CPU (Central Processing Unit), memory module, HDD (Hard Disk Drive) and PCIe/PCI card. Chapter 2 will show you how to install these hardware parts.

### 2.1 Installing the Processor

The Intel® Core™ i7/i5/i3 processors are available as a boxed processor for the IPC960-525/IPC962-525/IPC964-525 system. Intel recommends the processors should be installed by a qualified computer professional since this electronic device may cause serious damage to the installer, system and processor if installed improperly.

***Important Notes*** Before attempting to install a new processor, carefully review the documentation that came with your system and make sure that you will not be voiding your warranty by opening the computer or replacing your processor.

#### Instructions:

1. Make sure that your system can accommodate the Intel® Core™ i7/i5/i3/Celeron® processors that you want to install. Check for CPU card, BIOS, and thermal compatibility by using the manufacturer's documentation for the system, or by contacting the vendor if necessary. This processor should only be installed in systems supporting the Intel® Core™ i7/i5/i3/Celeron® processors.
2. Obtain access to your processor socket as described in the documentation for your system.
3. If the cooling solution prevents you from accessing the processor socket, you may need to remove it. Instructions on how to remove your cooling solution should be provided in the documentation that came with the system.

## 2.2 Procedure of Installation

This chapter will guide you on installing a processor.

- Step 1** Turn off the system.
- Step 2** Disconnect the power connector.
- Step 3** Loosen four screws to remove the heatsink cover from the chassis.



- Step 4** After opening the heatsink cover, you can locate the CPU socket as marked. Align pins of the CPU with the pin holes of the socket. Beware of the CPU's orientation when you align the arrow mark on the CPU with the arrow key on the socket. Remove the Mylar before you install the CPU into the socket.

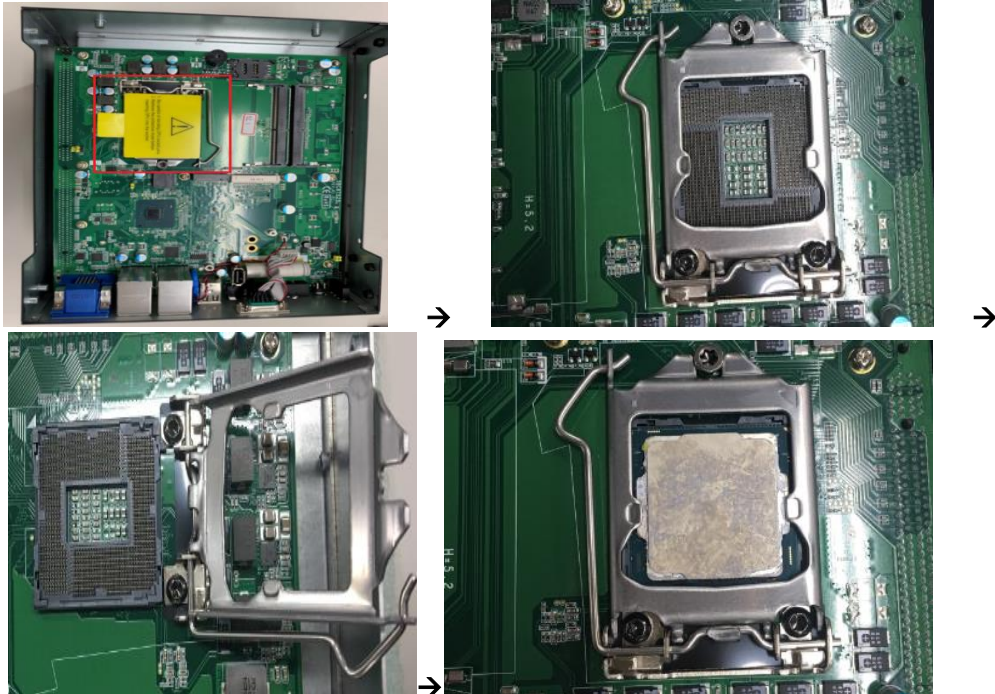

**Step 5** Apply thermal grease on top of the CPU.



**Step 6** After installing all components, close the heatsink cover back to the chassis and fasten all screws.

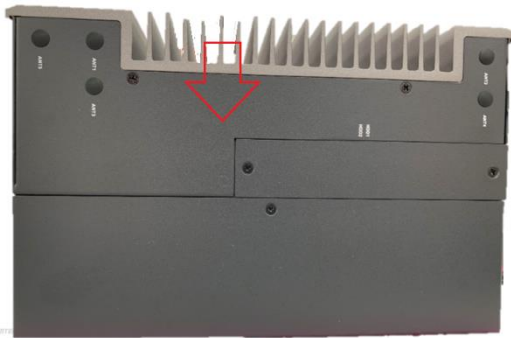

## 2.3 Installing the Memory Module

**Step 1** Turn off the system.

**Step 2** Disconnect the power connector.

**Step 3** Loosen four screws to remove the heatsink cover from the chassis.



**Step 4** Install the SO-DIMM (small outline dual in-line memory module) into the socket and push it firmly down until it is fully seated. The socket latches are clipped onto the edges of the memory module.

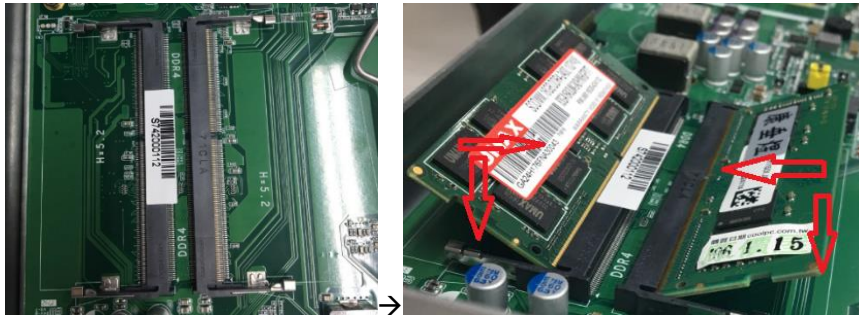

**Step 5** After installing the memory modules, close the heatsink cover back to the chassis and fasten all screws.

## 2.4 Installing the Hard Disk Drive

The IPC960-525/IPC962-525/IPC964-525 Series offers a convenient drive bay module for users to install HDD/SSD. The system offers users two 2.5" Hard Disk Drives for installation. Please follow the steps to install:

**Step 1** Turn off the system.

**Step 2** Disconnect the power connector.

**Step 3** Unscrew the two screws and remove the bracket from the HDD tray.



**Step 4** Open the HDD tray.





**Step 5** Align the connector of the HDD/SSD with the SATA slot of main board. Then, insert the HDD into the HDD tray.



**Note:** When using 7mm height HDD/SDD, please take the HDD spacer out of the accessory box and follow the following steps to stick it on HDD/SSD.



**Step 6** Screw the bracket. The installation is complete.



**Note:** The description of the 2.5" HDD tray (2in1) is as shown below.

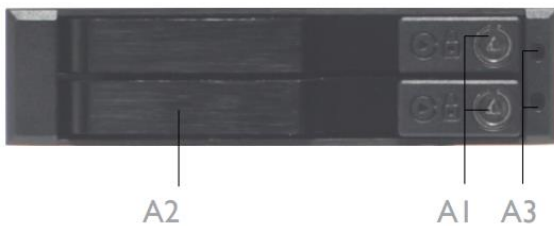

A1 : Triangular key lock  
A2 : Aluminum bezel  
A3 : Power & HDD access LED indication  
Power ON : Solid Green  
Accessing : Orange blinking

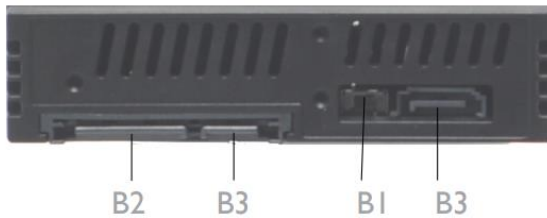

B1 : LED Switch ON : working status(see A3)  
LED Switch OFF : Solid Green for  
Power on and HDD accessing  
B2 : 15pin SATA Power connector.  
B3 : 7pin SATA data signal connector

## 2.5 Installing the expansion box kit

The IPC960-525-FL provides two/four-slot expansion box kit for expansion purposes. The procedure of installing the expansion box kit into system is instructed below.

**Step 1** Turn off the system.

**Step 2** Disconnect the power connector.

**Step 3** Loosen four screws to remove the system cover from the chassis.





**Step 4** Loosen the screw to remove the system cover from the expansion box kit.



**Step 5** Align the PCI or PCIe card with the slot, and press the card into the slot until it is firmly seated and screw it.

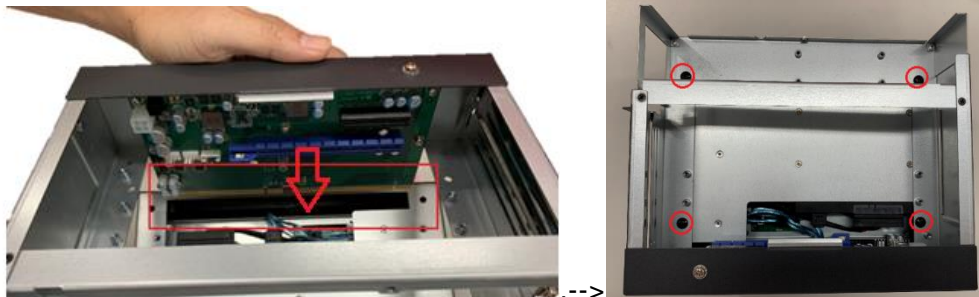

**Step 6** After installing the expansion box kit, close the system cover back to the chassis and fasten the screw. Installation is complete.



**Note:** The AX96410 and AX96411 expansion kits can be installed in IPC960-525-Q370 platform only.

## 2.6 Installing the Fan Module

The IPC962-525-FL/IPC964-525-FL provides either an internal fan module or an external fan module for optional selection. The procedure of installing the fan module into system is instructed below.

### 2.6.1 Installing Internal Fan Module

**Step 1** Please take the Mylar out of the accessory box. Screw the screws into the fan and fan bracket.

IPC962 series

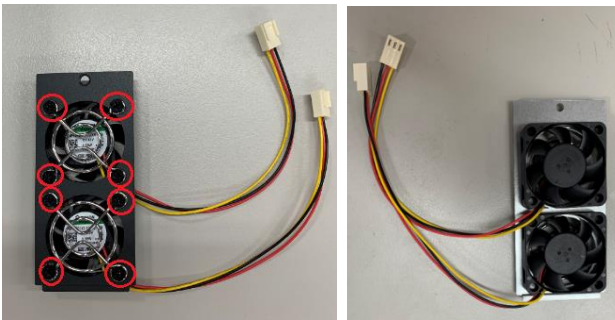

IPC964 series

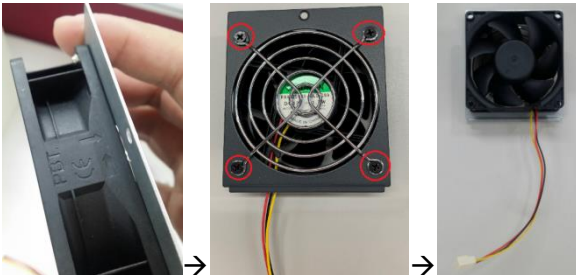

**Step 2** Turn off the system.

**Step 3** Disconnect the power connector.

**Step 4** Unscrew the system cover screw and remove the cover from the expansion box.



**Step 5** Unscrew the bracket, fasten the fan module into the expansion box and plug cable(s) to connector(s).

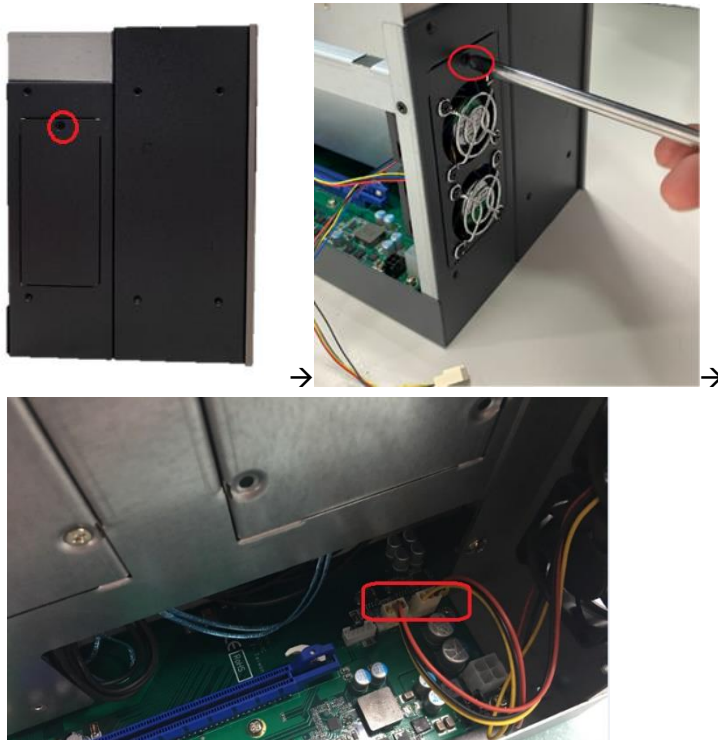

**Step 6** After installing the fan module, close the system cover back to the chassis and fasten the screw. Installation is complete.

## 2.6.2 Installing external Fan Module

**Step 1** Please take the Mylar out of the accessory box. Screw the fan to the fan bracket.

IPC962 series

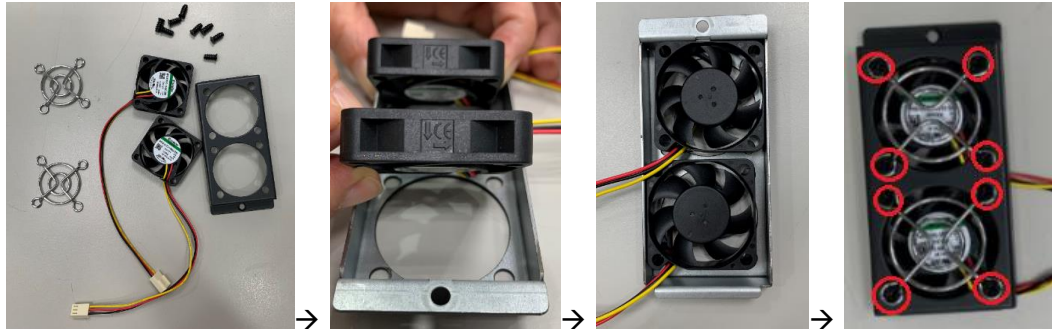

IPC964 series

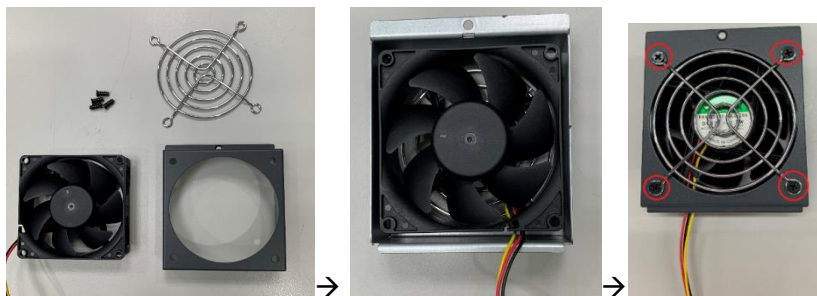

**Step 2** Turn off the system.

**Step 3** Disconnect the power connector.

**Step 4** Unscrew the system cover screw and remove the cover from the expansion box.



**Step 5** Unscrew the bracket, fasten the fan module into the expansion box and plug cable(s) to connector(s).

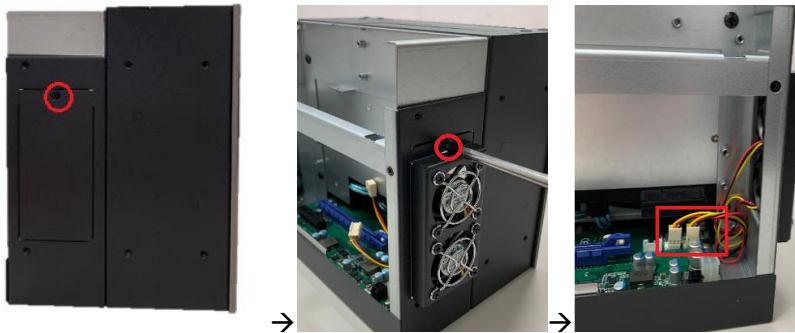

**Step 6** After installing the fan module, close the system cover back to the chassis and fasten the screw. Installation is complete.



**Note:** Reserve at least 25mm space from the rear side for optimal fan air flow.

## 2.7 Installing PCI or PCIe Card

The IPC962-525-FL/IPC964-525-FL provides two/four PCI or PCIe slots for expansion. The procedure of installing the fan module and PCI / PCIe expansion card into system is instructed below.

### 2.7.1 Installing PCI or PCIe card

**Step 1** Turn off the system.

**Step 2** Disconnect the power connector.

**Step 3** Unscrew the system cover screw and remove the cover from the expansion box.



**Step 4** Locate the PCI or PCIe slots and remove the slot bracket from the slot in which you want to add the card.



**Step 5** Align the PCI or PCIe card with the slot, press the card into the slot until it is firmly seated and screw it. Then, plug the graphics card power cable.

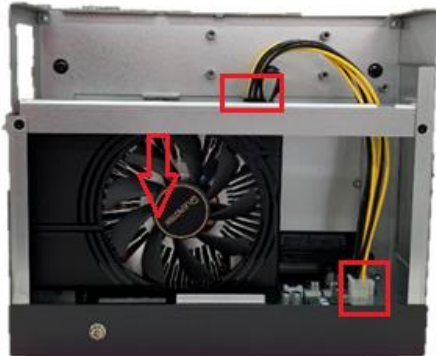

**Note:** The graphics card power cable will be needed when the graphics card power is over 75W.



**Note:** 12V maximum loading 12A (144W).

**Step 6** Please take the holder bracket and screws from the accessory box. Fasten the below bracket in chassis with standard height (111mm) add-on cards.





**Step 7** IPC962 and IPC964 offer 3 types of extension holder brackets. Please take the brackets and screws from the accessory box and assemble the extension holder bracket. The procedure is illustrated below.



**Step 8** Assemble the extension holder bracket, as illustrated below.

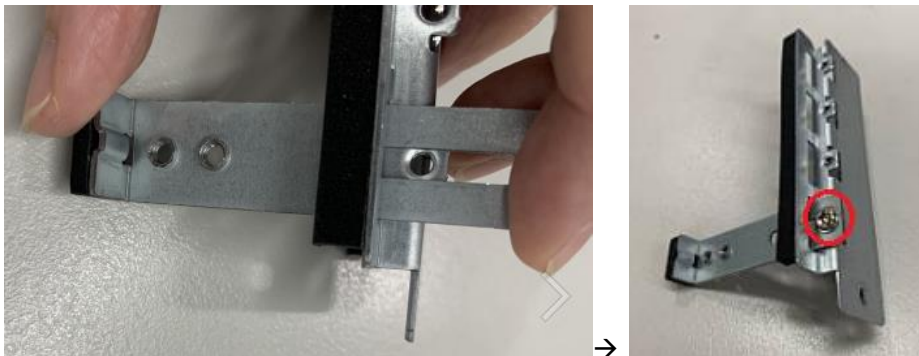

Or

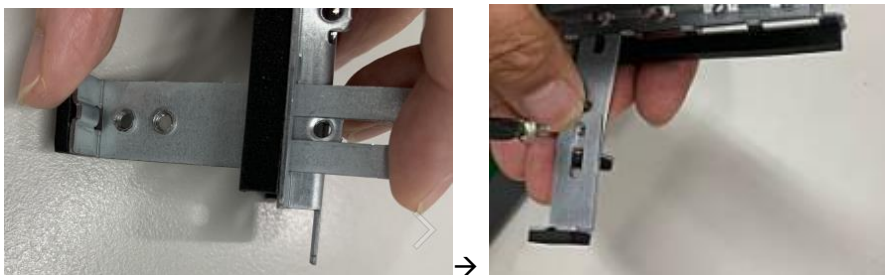

**Step 9** Fasten the holder bracket in the chassis, adjust the screw position of the extension bracket to fix the add-on card, and then screw it.



**Step 10** Close the cover back to the chassis and fasten the screw. The installation is complete.

### 2.7.2 The limitation of an add-on card

The following figures show the limitation of an add-in card in different configuration.

IPC962-525

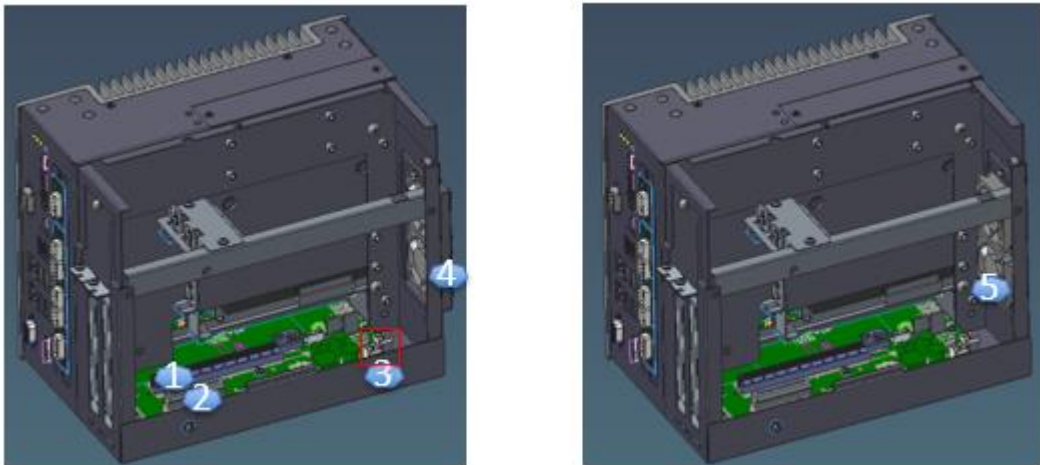

No.	Description	No.	Description
1	Slot 1: PCIe x 16	4	External fan module
2	Slot 2: PCIe x4 or PCI	5	Internal fan module
3	Power connector of AX96205 or AX96206 or AX96207(riser)		



 **Note:** Please note that below dimension is the maximum length for add-on card with I/O bracket.

 **Note:** Considering heat dissipation potential, a space of 20mm must be left between add-on card and system.

Fan module is un-installed.

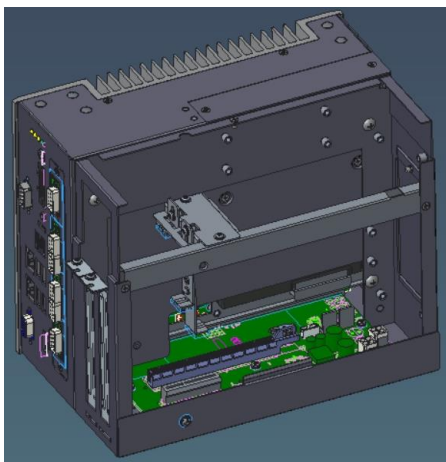
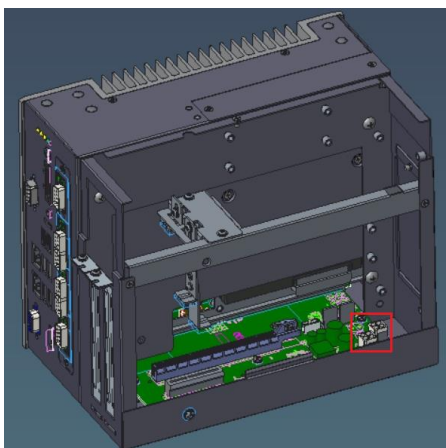
	Slot 1 (PCIe x16)	Slot 2 (PCIe x4 or PCI)
height	49.48-119.78 (mm)	49.48-119.78 (mm)
width	20.32(mm)	20.32(mm)
<b>The following shows each slot's max. length for add-in card in the system with different configurations.</b>		
1) Riser card's power cable is un-installed.	234.07(mm)	234.07(mm)
		
2) Riser card's power cable is installed.	185.00(mm)	185.00(mm)
		

External fan module is installed.

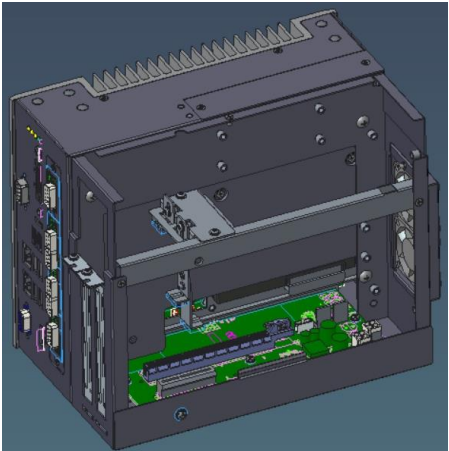
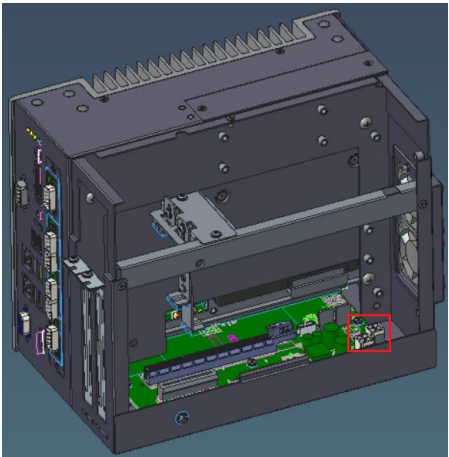
	Slot 1 (PCIe x16)	Slot 2 (PCIe x4 or PCI)
height	49.48-119.78 (mm)	49.48-119.78 (mm)
width	20.32(mm)	20.32(mm)
<b>The following shows each slot's max. length for add-in card in the system with different configurations.</b>		
1) Riser card's power cable is un-installed.	234.07(mm)	234.07(mm)
		
2) Riser card's power cable is installed.	185.00(mm)	185.00(mm)
		

Internal fan module is installed.

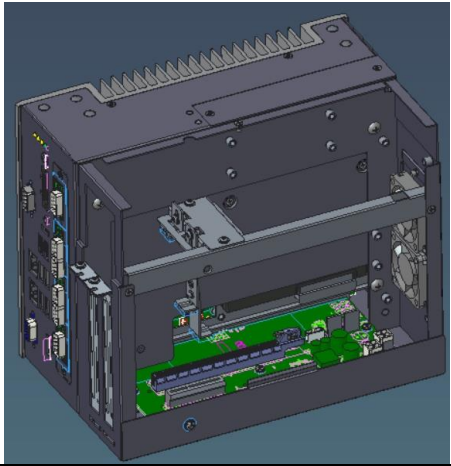
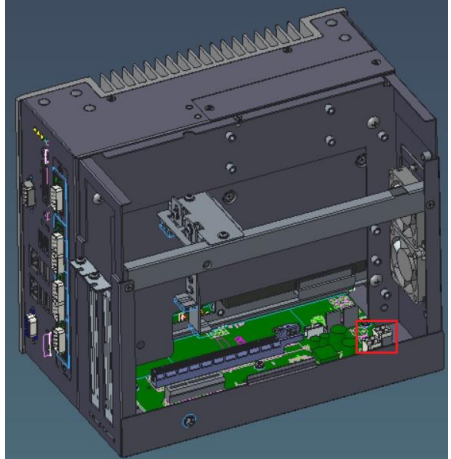
	Slot 1 (PCIe x16)	Slot 2 (PCIe x4 or PCI)
height	49.48-119.78 (mm)	49.48-119.78 (mm)
width	20.32(mm)	20.32(mm)
<b>The following shows each slot's max. length for add-in card in the system with different configurations.</b>		
1) Riser card's power cable is un-installed.	229.07(mm)	229.07(mm)
		
2) Riser card's power cable is installed.	185.00(mm)	185.00(mm)
		

IPC964-525

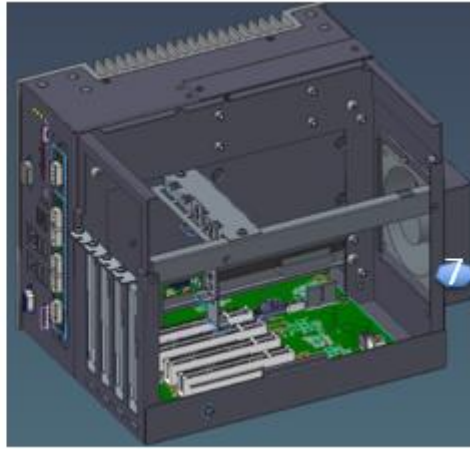
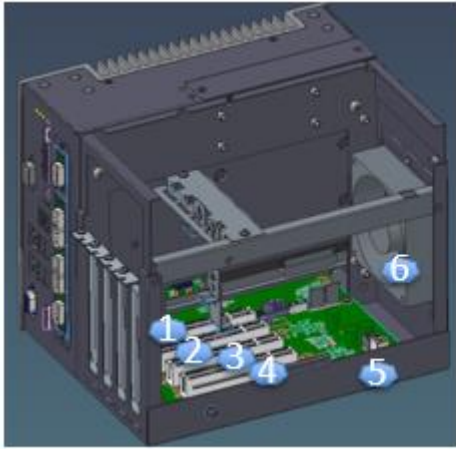

No.	Description	No.	Description
1	Slot 1: PCIe x 16	5	Power connector of AX96410 or AX96411(riser)
2	Slot 2: PCIe x4	6	Internal fan module
3	Slot 3: PCIe x4 or PCI	7	External fan module
4	Slot 4: PCIe x4 or PCI		



**Note:** Please note that below dimension is the maximum length for add-on card with I/O bracket.



**Note:** Considering heat dissipation potential, a space of 20mm must be left between add-on card and system.

Fan module is un-installed.

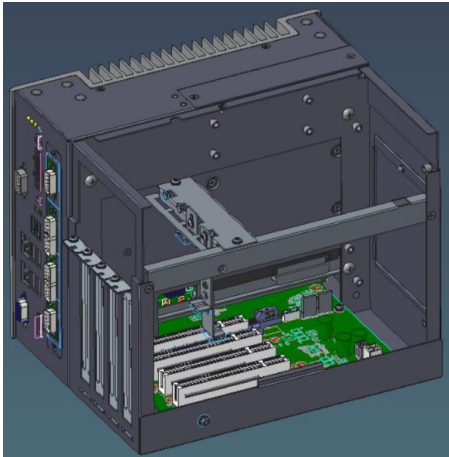
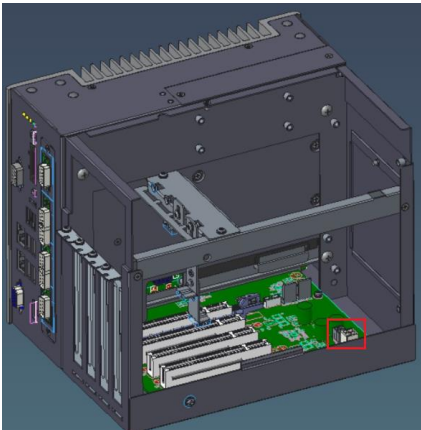
	Slot 1 (PCIe x16)	Slot 2 (PCIe x4)	Slot 3 (PCI x4 or PCI)	Slot 4 (PCI x4 or PCI)
height	49.48-119.78 (mm)	49.48-119.78 (mm)	49.48-119.78 (mm)	49.48- 119.78 (mm)
width	20.32(mm)	20.32(mm)	20.32(mm)	20.32(mm)
<b>The following shows each slot's max. length for add-in card in the system with different configurations.</b>				
1) Riser card's power cable is un-installed.	234.07(mm)	234.07(mm)	234.07(mm)	234.07(mm)
				
2) Riser card's power cable is installed.	234.07(mm)	234.07(mm)	185.00(mm)	185.00(mm)
				

Internal fan module is installed.

	Slot 1 (PCIe x16)	Slot 2 (PCIe x4)	Slot 3 (PCI x4 or PCI)	Slot 4 (PCI x4 or PCI)
height	113.06 (mm)	113.06 (mm)	113.06 (mm)	113.06 (mm)
width	20.32(mm)	20.32(mm)	20.32(mm)	20.32(mm)

**The following shows each slot's max. length for add-in card in the system with different configurations.**

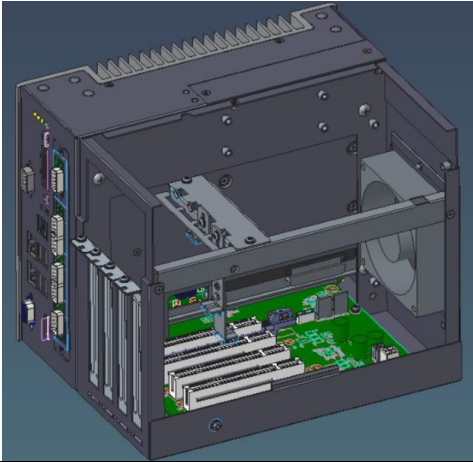
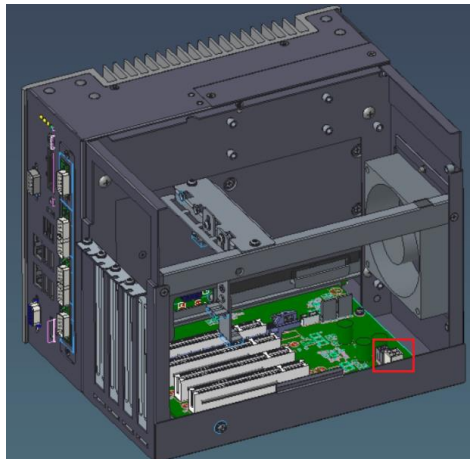
1) Riser card's power cable is un-installed.	214.07(mm)	214.07(m m)	214.07(mm)	214.07(mm)
				
2) Riser card's power cable is installed.	214.07(mm)	214.07(m m)	185.00(mm)	185.00(mm)
				

External fan module is installed.

	Slot 1 (PCIe x16)	Slot 2 (PCIe x4)	Slot 3 (PCI x4 or PCI)	Slot 4 (PCI x4 or PCI)
height	113.06 (mm)	113.06 (mm)	113.06 (mm)	113.06 (mm)
width	20.32(mm)	20.32(mm)	20.32(mm)	20.32(mm)

**The following shows each slot's max. length for add-in card in the system with different configurations.**

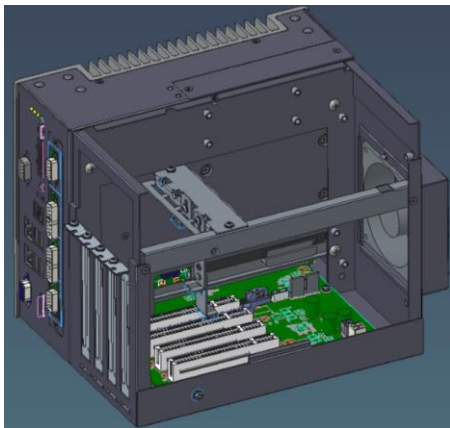
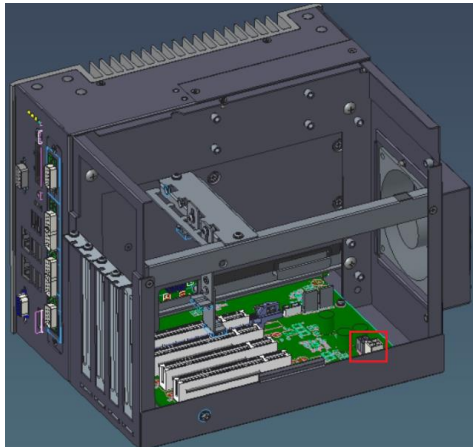
1) Riser card's power cable is un-installed.	234.07(m m)	234.07(mm)	234.07(mm)	234.07(mm)
				
2) Riser card's power cable is installed.	234.07(m m)	234.07(mm)	185.00(mm)	185.00(mm)
				



### 2.7.3 Installing T4 graphics card w/T4 fan module

**Step 1** Please take the Mylar from the accessory box. Then paste it on the cover 's vents.

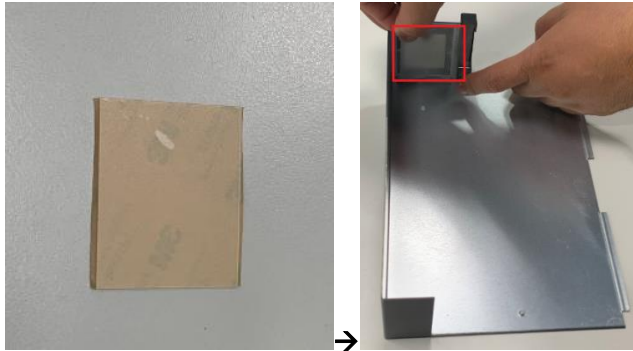

**Step 2** Please take the fan module kit from the accessory box.



**Step 3** Screw the eight screws into fan and fan bracket.

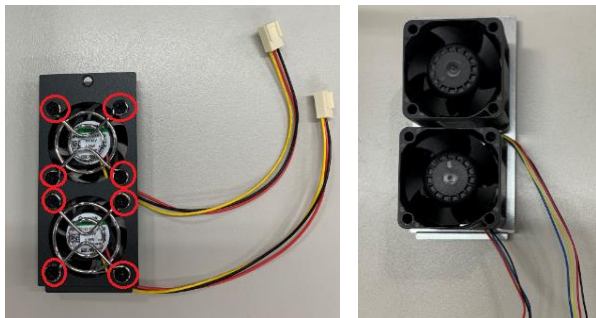



**Step 4** Paste the 4 poron pads on air duct brackets, as illustrated below.

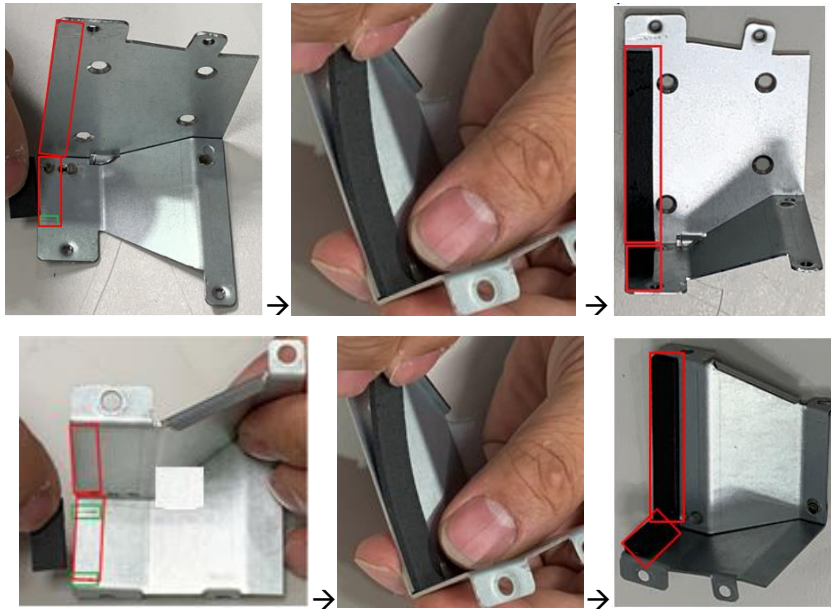

**Step 5** Screw the bracket into chassis.

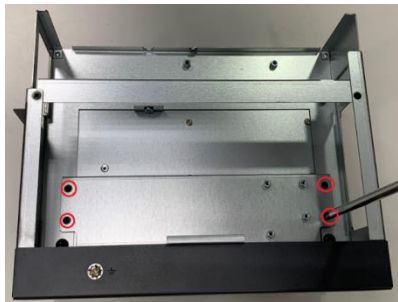

**Step 6** Screw the fan module into chassis and plug in the fan connectors.

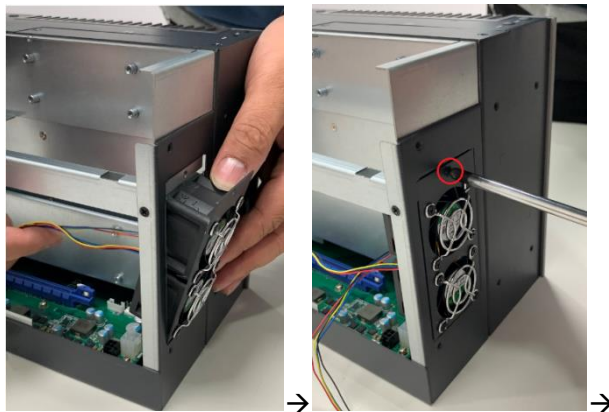

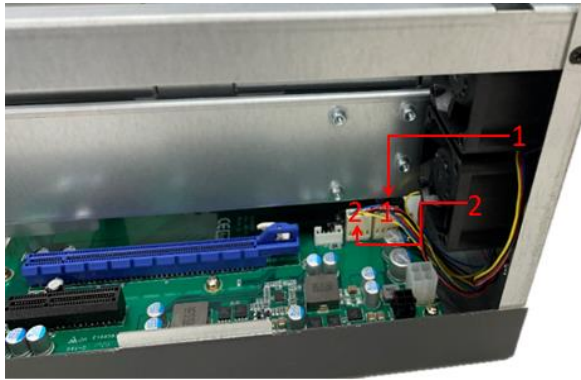

**Step 7** Route the cables and put the cables in red mark area, as illustrated below.

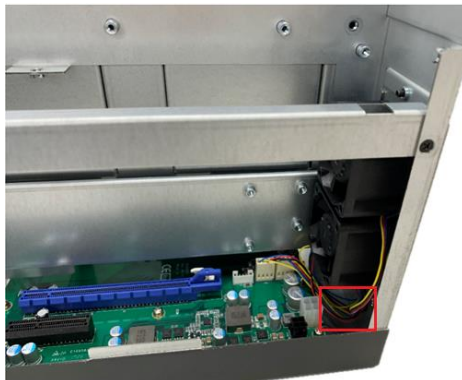

**Step 8** Remove the slot brackets.



**Step 9** Insert the air duct bracket's metal part as marked A below and screw the 4 screws.

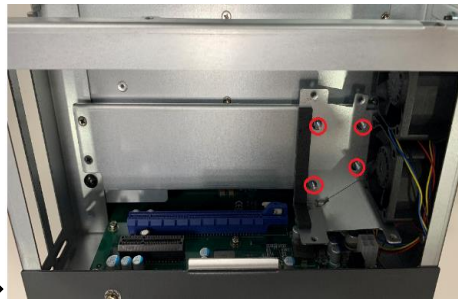
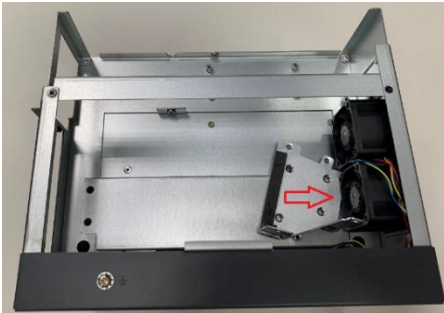
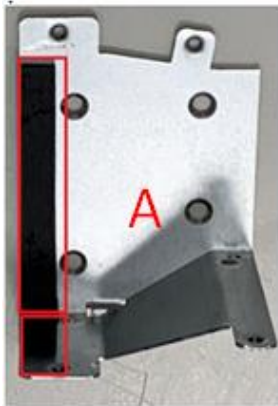

**Step 10** Align the T4 card with the slot, press the card into the slot until it is firmly seated, and screw the T4 card bracket and slot bracket to the chassis.



**Step 11** Insert the air duct bracket's metal part as marked B below and screw the 4 screws.

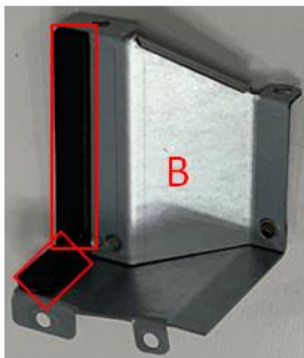

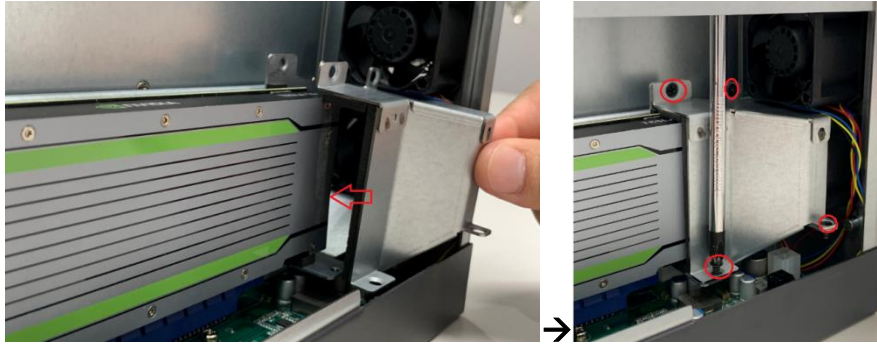

**Step 12** Paste the Mylar on the vents of the system cover.

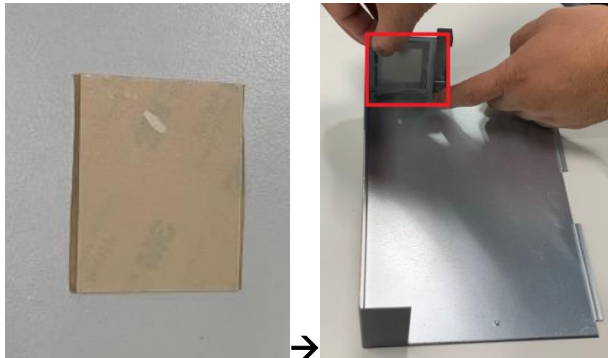

**Step 13** Close the cover back to the chassis and fasten the screw. The installation is complete.



**Note:** Please note the T4 FAN module kit supports IPC962 w/AX96205 and IPC960 w/AX96205 expansion box kit only.



**Note:** Please note the power connector on the riser card can't be used in IPC962 w/AX96205 and T4 fan module kit configuration.

IPC962

System configuration: w/ AX96205 & T4 & w/ T4 fan module kit

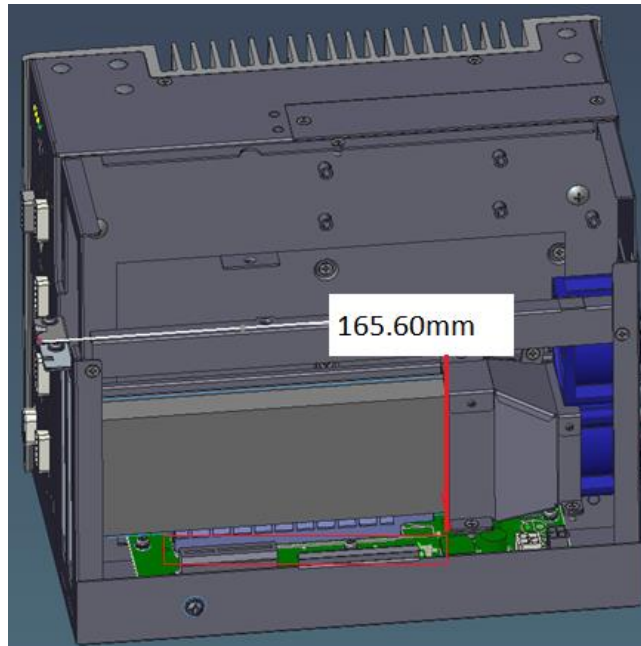

**Note:** Please note that 165mm of the 2<sup>nd</sup> slot is the maximum length for add-on card with I/O bracket. considering heat dissipation potential, a space of 5mm must be kept between the add-on card and T4 fan bracket.



## 2.8 Installing the Mini Card Module

The IPC960, IPC962 and IPC964 come with a mini card slot for users to install a wireless LAN card. Please refer to the following instructions and illustrations for the installation of the wireless LAN.

- Step 1** Please take the wireless LAN card from the accessory box.
- Step 2** Turn off the system.
- Step 3** Disconnect the power connector.
- Step 4** Loosen screws to remove the heatsink cover from the chassis.



- Step 5** Insert the wireless LAN card into the slot and push it down firmly. Then screw the card tightly to the mainboard



- Step 6** Remove the antenna plugs from the top of back cover, and then install the antennas on the antenna connectors.



- Step 7** Close the cover back to the chassis and fasten all screws. The installation is complete.



**Note:** Please use an extended bracket when using a half-size Mini card



**Note:** a) 1 x on board full-size PCI Express Mini Card slot with USB/PCIe interface (IPC962-525-Q370/IPC964-525-Q370)

b) 1 x on board full-size PCI Express Mini Card slot with USB interface (IPC962-525-H310)



**Note:** The IPC960, IPC962 and IPC964 support either a mini card slot or an M.2 Key B slot.

## 2.9 Installing the 5G Wireless Module

The IPC960, IPC962 and IPC964 come with an M.2 Key B 3042/3050 slot for users to install a 5G wireless card. Please refer to the following instructions and illustrations for the installation of the 5G wireless module.

- Step 1** Please take the 5G module kit from the accessory box.



- Step 2** Paste the thermal pad on the bottom side of the module, as illustrated below.

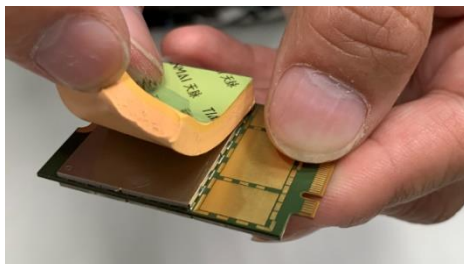

**Step 3** Turn off the system.

**Step 4** Disconnect the power connector.

**Step 5** Loosen screws to remove the heatsink cover from the chassis.



**Step 6** Insert the 5G wireless module into the slot and push it down firmly. Then screw the card tightly to the mainboard.

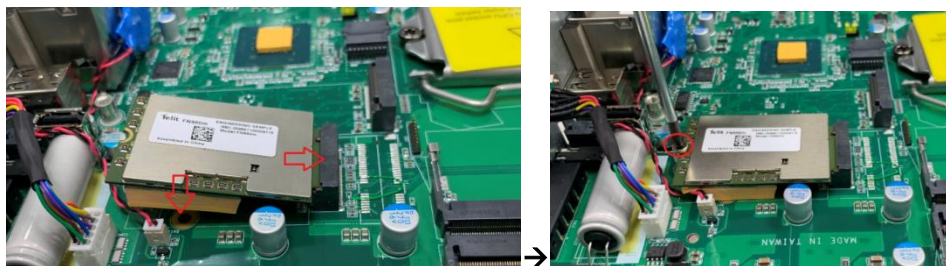

**Step 7** Paste the other thermal pad on top of the module, as illustrated below.





- Step 8** Remove the antenna plugs from the top of the back cover, install the antennas on the antenna connectors as marked in the illustration below, and then insert the SIM card into the SIM slot.

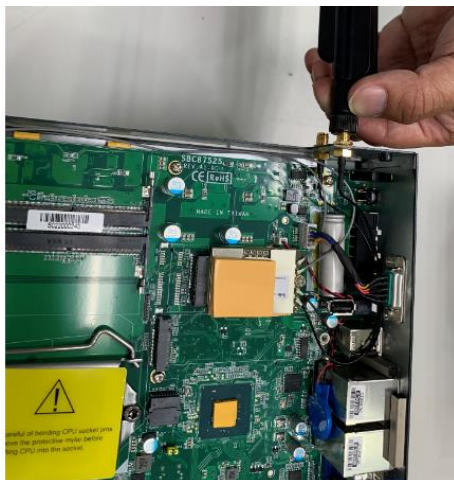
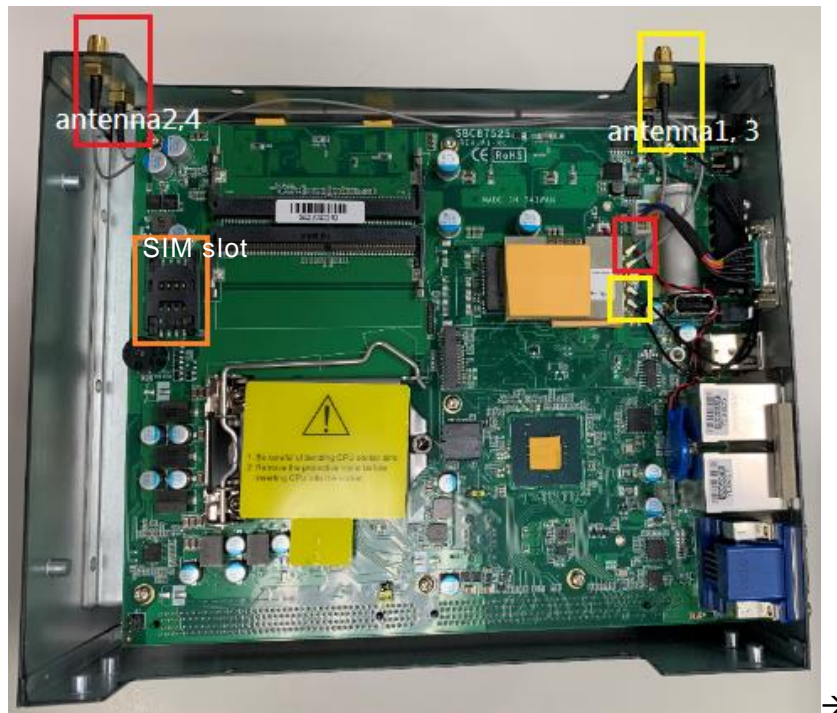

- Step 9** Close the cover back to the chassis and fasten all screws. The installation is complete.



**Note:** Only Q370 platforms can support an M.2 Key B slot.



**Note:** The thermal solution might be changed due to the different 5G module installed.



**Note:** The IPC960, IPC962 and IPC964 support either a mini card slot or an M.2 Key B slot.

## 2.10 Installing the NVMe SSD Module

The IPC960, IPC962 and IPC964 come with an M.2 Key M 2280 socket (PCIe Gen3 x4) for users to install an NVMe SSD module. Please refer to the following instructions and illustrations for the installation of the NVMe SSD module.

**Step 1** Please take the NVMe SSD module kit from the accessory box.

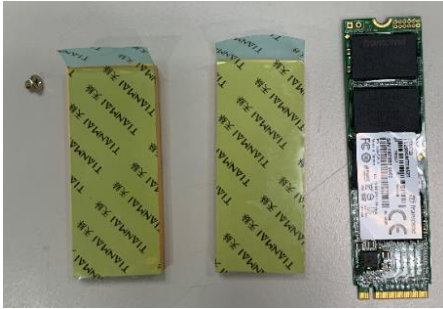

**Step 2** Turn off the system.

**Step 3** Disconnect the power connector.

**Step 4** Loosen screws to remove the heatsink cover from the chassis.



**Step 5** Align the thermal pad with the slot and paste it on the slot. Remember to remove the protective film from the thermal pad.

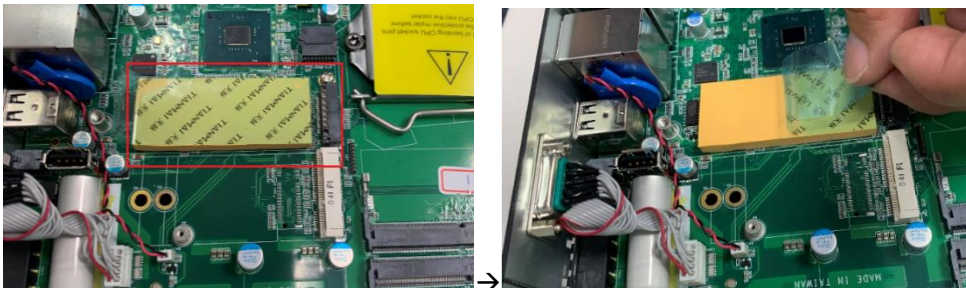

**Step 6** Insert the SSD card to slot and push it down firmly. Then screw the card tightly to the mainboard.

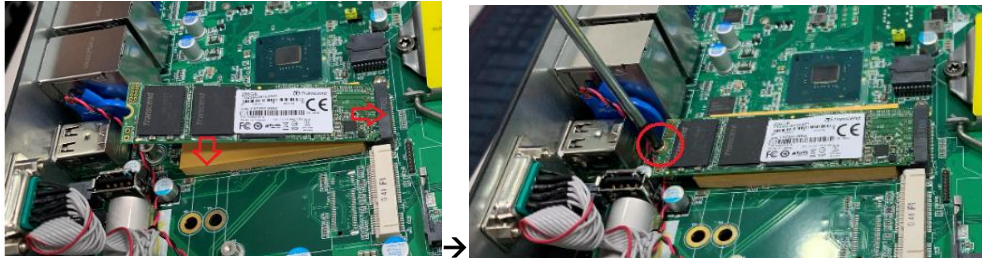

**Step 7** Paste the other thermal pad on the module and then remove the protective film, as illustrated below.



**Step 8** Close the cover back to the chassis and fasten all screws. The installation is complete.



**Note:** Only Q370 platforms can support an NVMe SSD Key M slot.

## 2.11 Mounting

The IPC960-525/IPC962-525/IPC964-525 provides versatile mount kits for optional selection.

DIN rail mounting

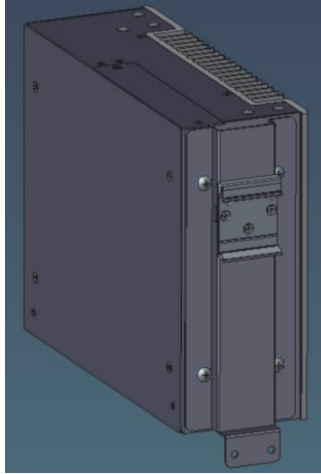

**Note:** The DIN rail kit can be installed in IPC960 system only.

Wall mounting

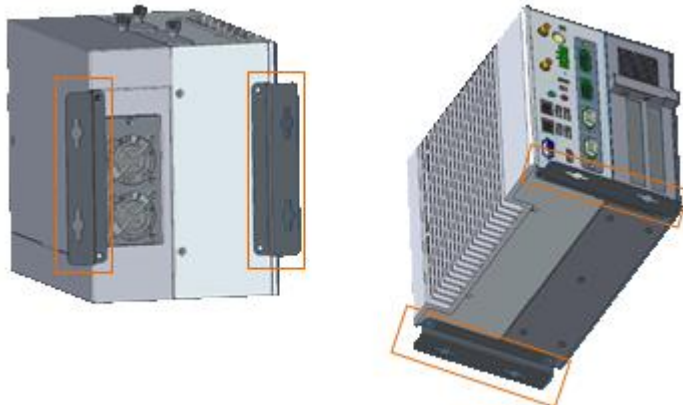

**Note:** The IPC960 supports either DIN rail kit or wall mount kit.

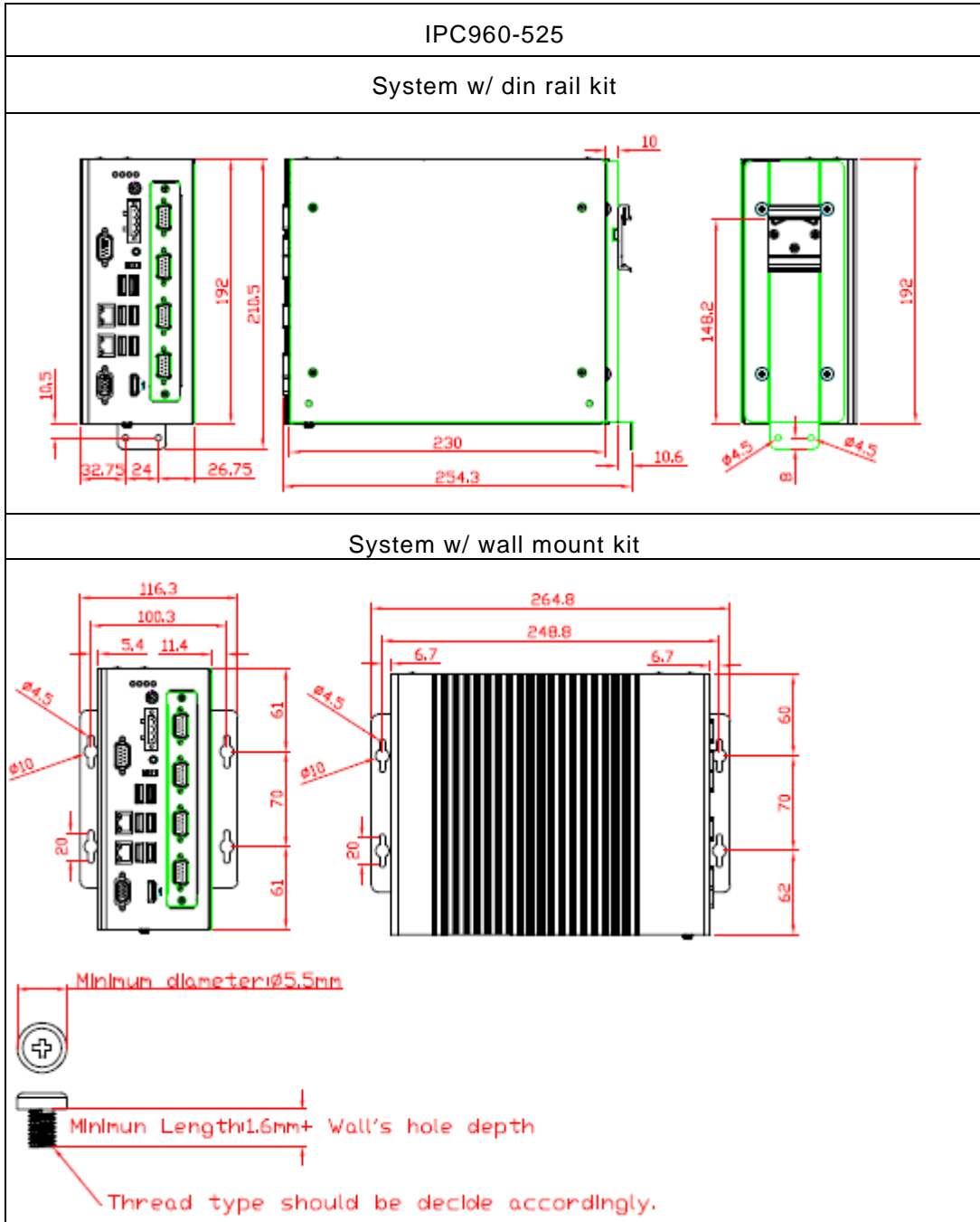

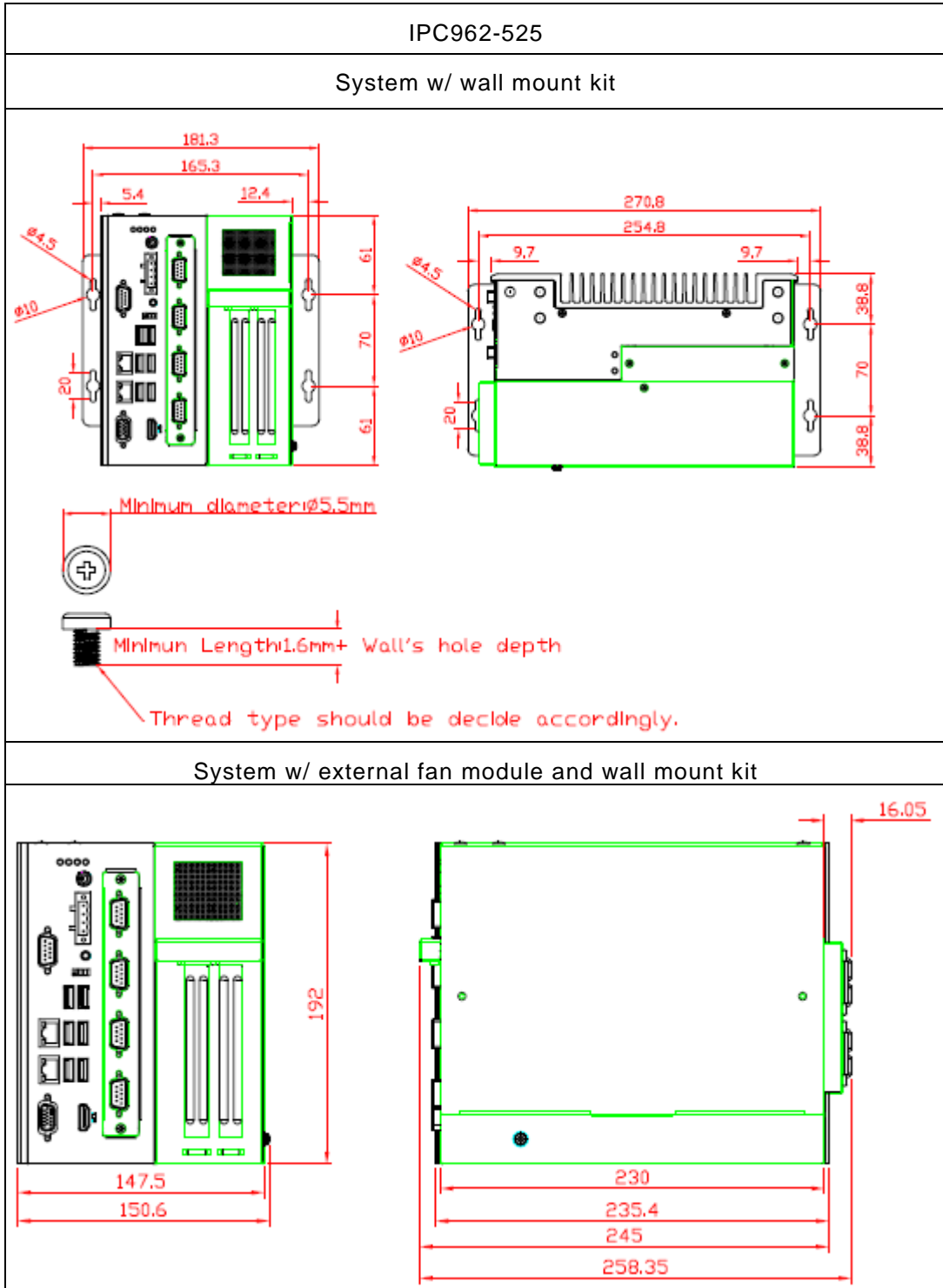



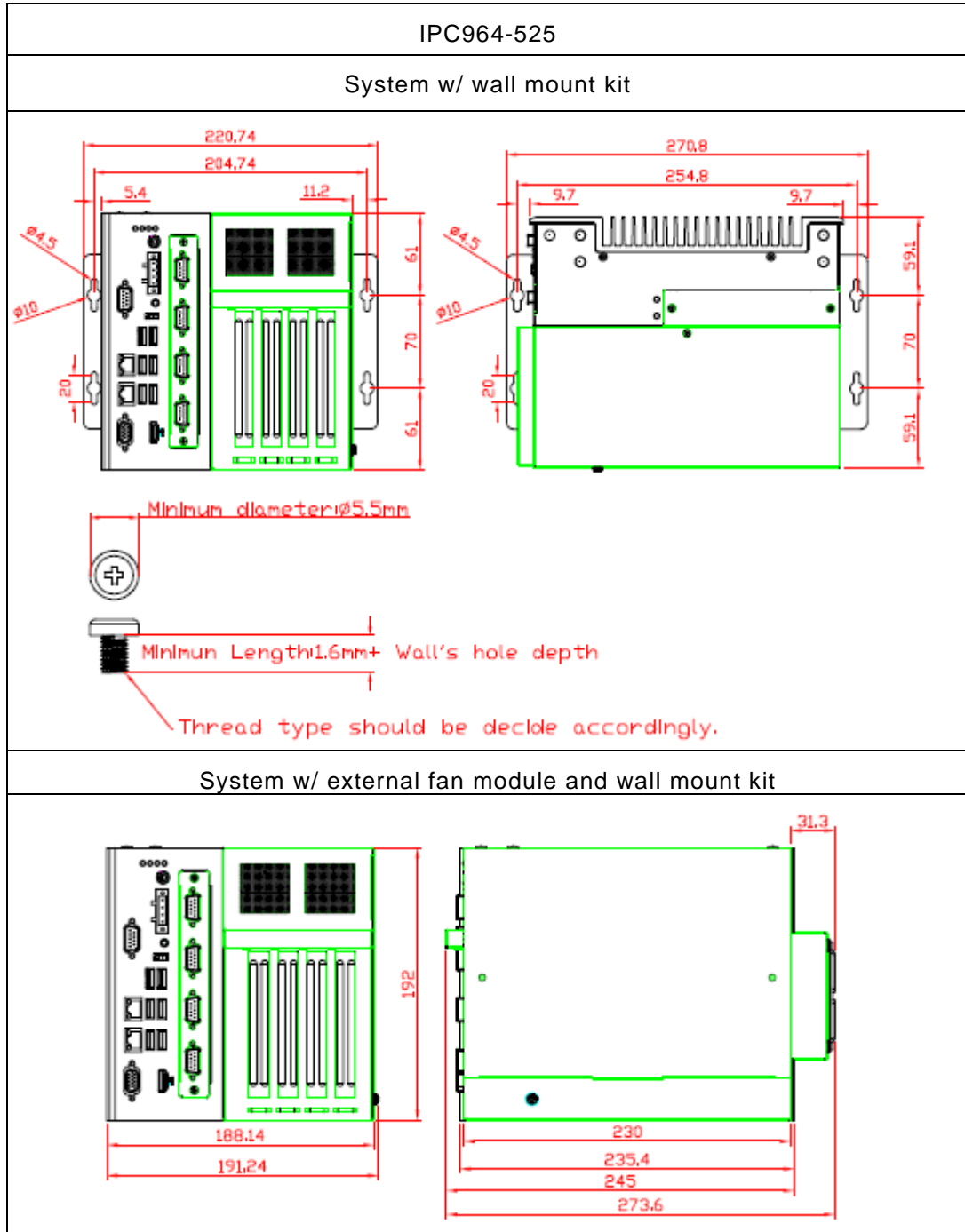

**This page is intentionally left blank.**



## SECTION 3

# AMI BIOS UTILITY

The AMI UEFI BIOS provides users with a built-in setup program to modify basic system configuration. All configured parameters are stored in a 16MB flash chip to save the setup information whenever the power is turned off. This chapter provides users with detailed description about how to set up basic system configuration through the AMI BIOS setup utility.

### 3.1 Starting

To enter the setup screens, follow the steps below:

1. Turn on the computer and press the <Del> key immediately.
2. After you press the <Del> key, the main BIOS setup menu displays. You can access the other setup screens from the main BIOS setup menu, such as the Advanced and Chipset menus.



**Note:** *If your computer cannot boot after making and saving system changes with Setup, you can restore BIOS optimal defaults by setting JP1 (see section 1.6.2).*

It is strongly recommended that you should avoid changing the chipset's defaults. Both AMI and your system manufacturer have carefully set up these defaults that provide the best performance and reliability.

## 3.2 Navigation Keys

The BIOS setup/utility uses a key-based navigation system called hot keys. Most of the BIOS setup utility hot keys can be used at any time during the setup navigation process. These keys include <F1>, <F2>, <Enter>, <ESC>, <Arrow> keys, and so on.



**Note:** Some of the navigation keys differ from one screen to another.

Hot Keys	Description
→← Left/Right	The Left and Right <Arrow> keys allow you to select a setup screen.
↑↓ Up/Down	The Up and Down <Arrow> keys allow you to select a setup screen or sub-screen.
+– Plus/Minus	The Plus and Minus <Arrow> keys allow you to change the field value of a particular setup item.
Tab	The <Tab> key allows you to select setup fields.
F1	The <F1> key allows you to display the General Help screen.
F2	The <F2> key allows you to Load Previous Values.
F3	The <F3> key allows you to Load Optimized Defaults.
F4	The <F4> key allows you to save any changes you have made and exit Setup. Press the <F4> key to save your changes.
Esc	The <Esc> key allows you to discard any changes you have made and exit the Setup. Press the <Esc> key to exit the setup without saving your changes.
Enter	The <Enter> key allows you to display or change the setup option listed for a particular setup item. The <Enter> key can also allow you to display the setup sub- screens.

### 3.3 Main Menu

The first time you enter the setup utility, you will be in the Main setup screen. You can always return to the Main setup screen by selecting the Main tab. System Time/Date can be set up as described below. The Main BIOS setup screen is shown below.

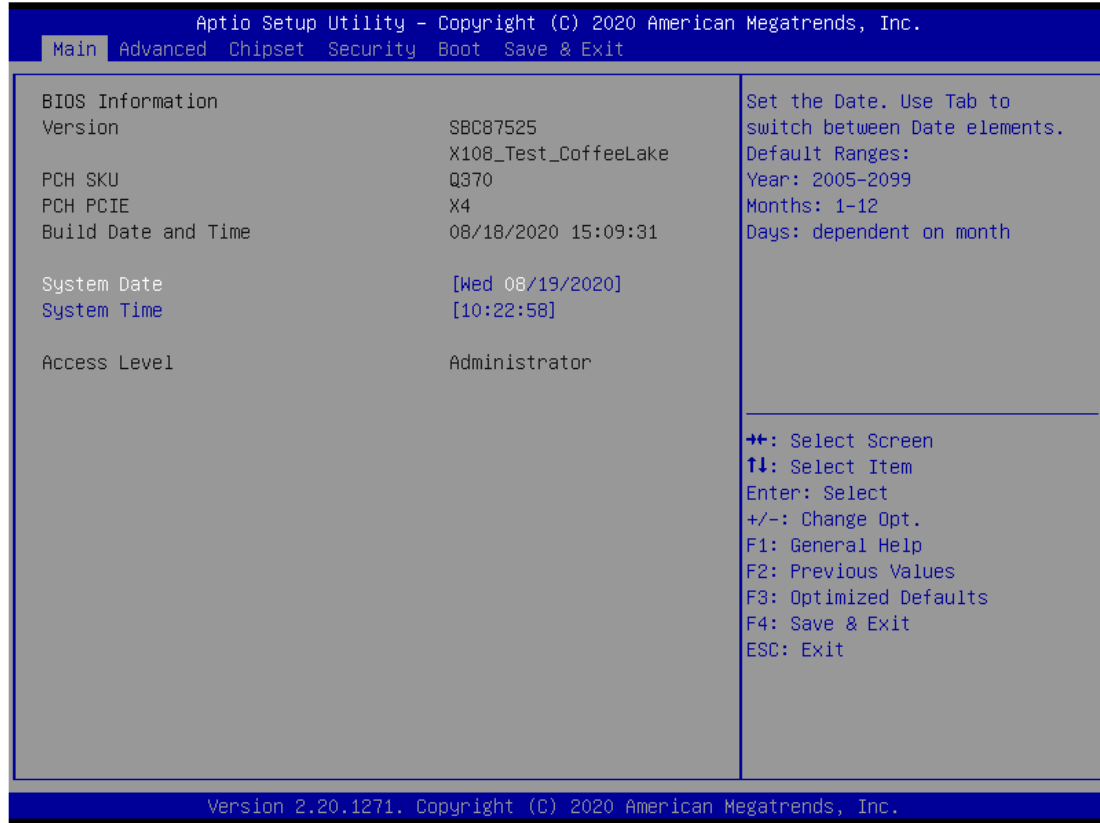

- **System Date/Time**

Use this option to change the system time and date. Highlight System Time or System Date using the <Arrow> keys. Enter new values through the keyboard. Press the <Tab> key or the <Arrow> keys to move between fields. The date must be entered in MM/DD/YY format. The time is entered in HH:MM:SS format.

### 3.4 Advanced Menu

- **Launch PXE OpROM**

Use this item to enable or disable the boot ROM function of the onboard LAN chip when the system boots up.

The Advanced menu also allows users to set configuration of the CPU and other system devices. You can select any of the items in the left frame of the screen to go to the sub menus.

For items marked with “▶”, please press <Enter> for more options.

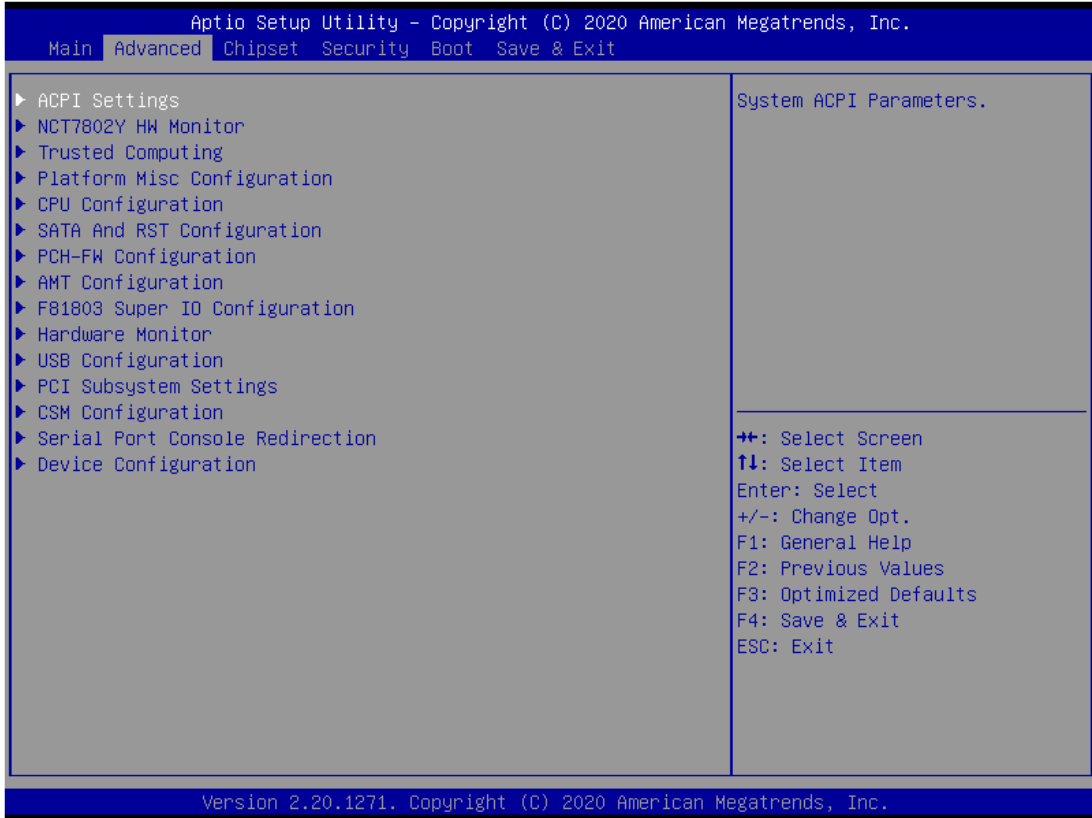

- **HW Monitor**

This screen monitors hardware health.

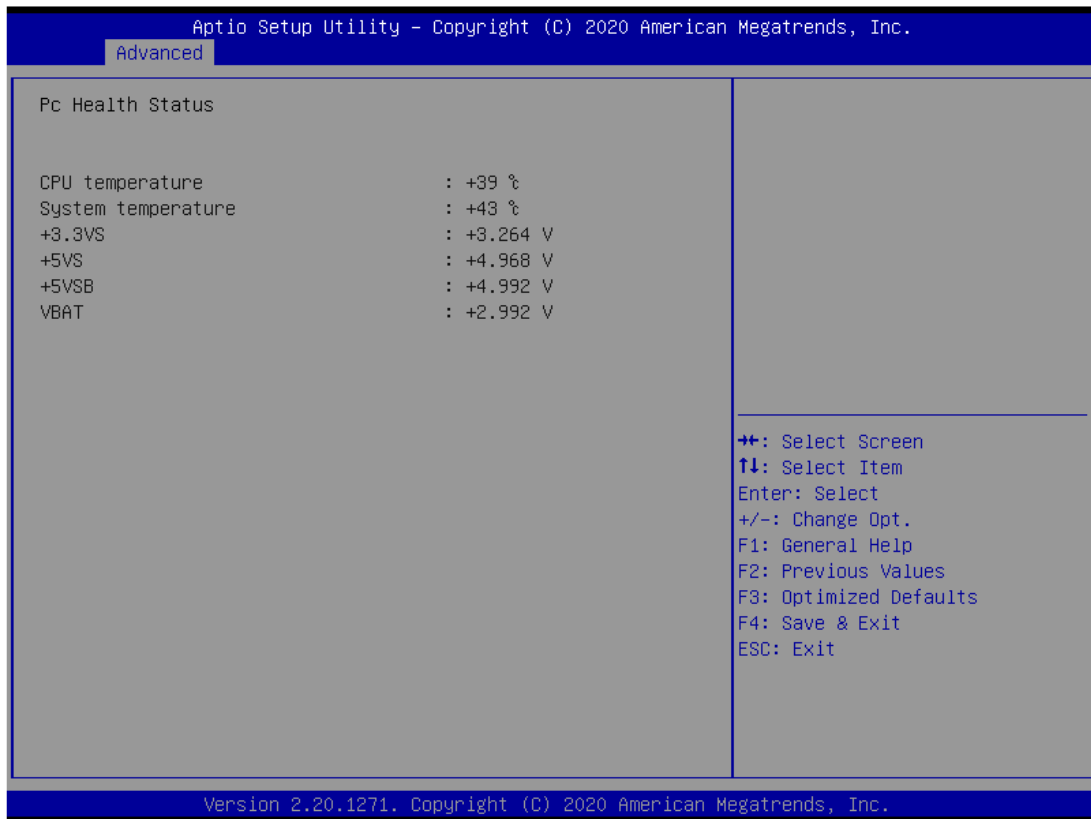

- **7802Y HW Monitor**

This screen monitors fan speed.

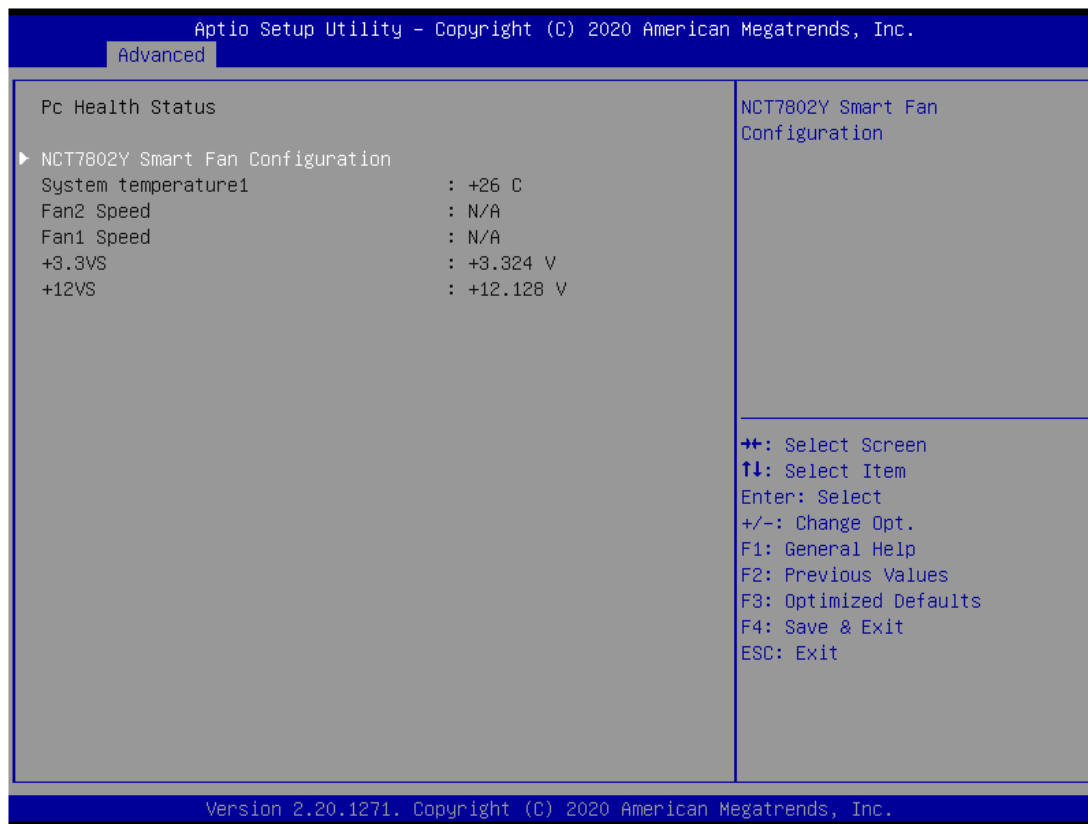

● **Ethercat Configuration**

Setting "Disable" mode in the following 5 itmes to support Ethercat.

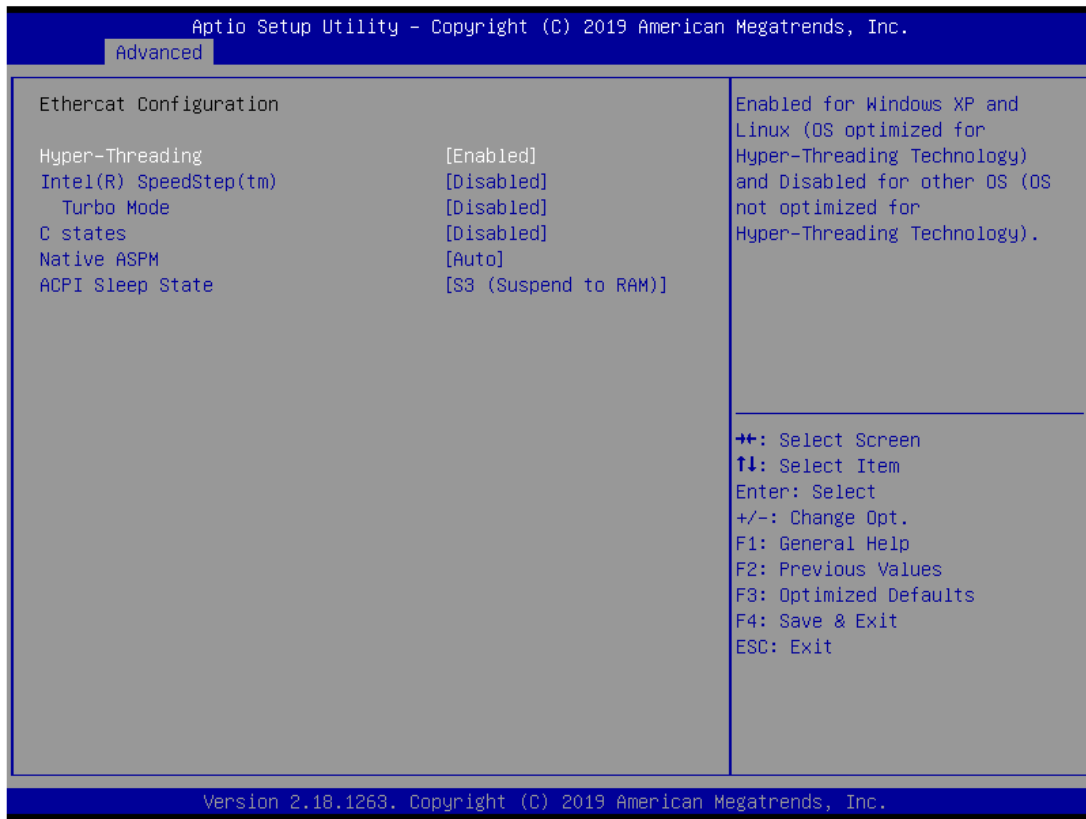

- **ME**

Display ME firmware information.





- **ACPI Settings**

ACPI configuration can be configured in ACPI Settings. A description of the selected item appears on the right side of the screen.



- **ACPI Sleep State**

Select the highest ACPI sleep state the system will enter when the suspend button is pressed. Configuration options are Suspend S3 only (Suspend to RAM).

● **Trusted Computing**

Select Security Device Support to enable or disable the TPM function.

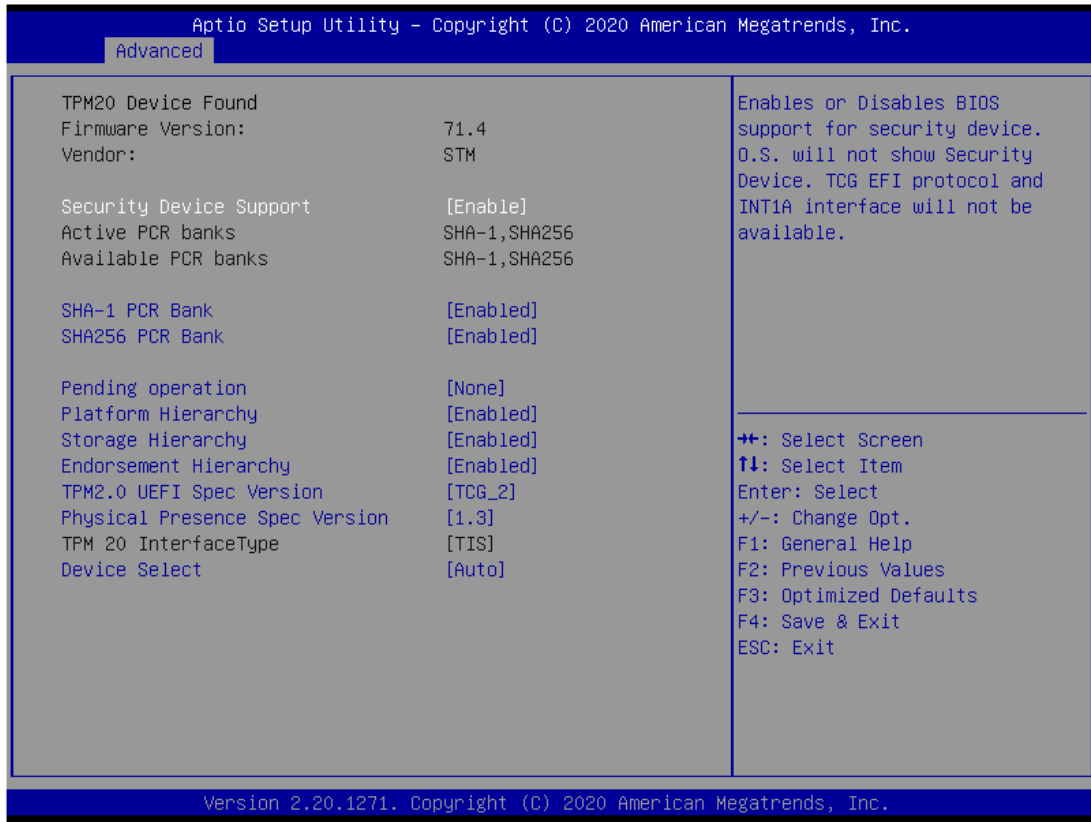

- **CPU Configuration**

This screen shows the CPU configuration, and you can change the value of the selected option.

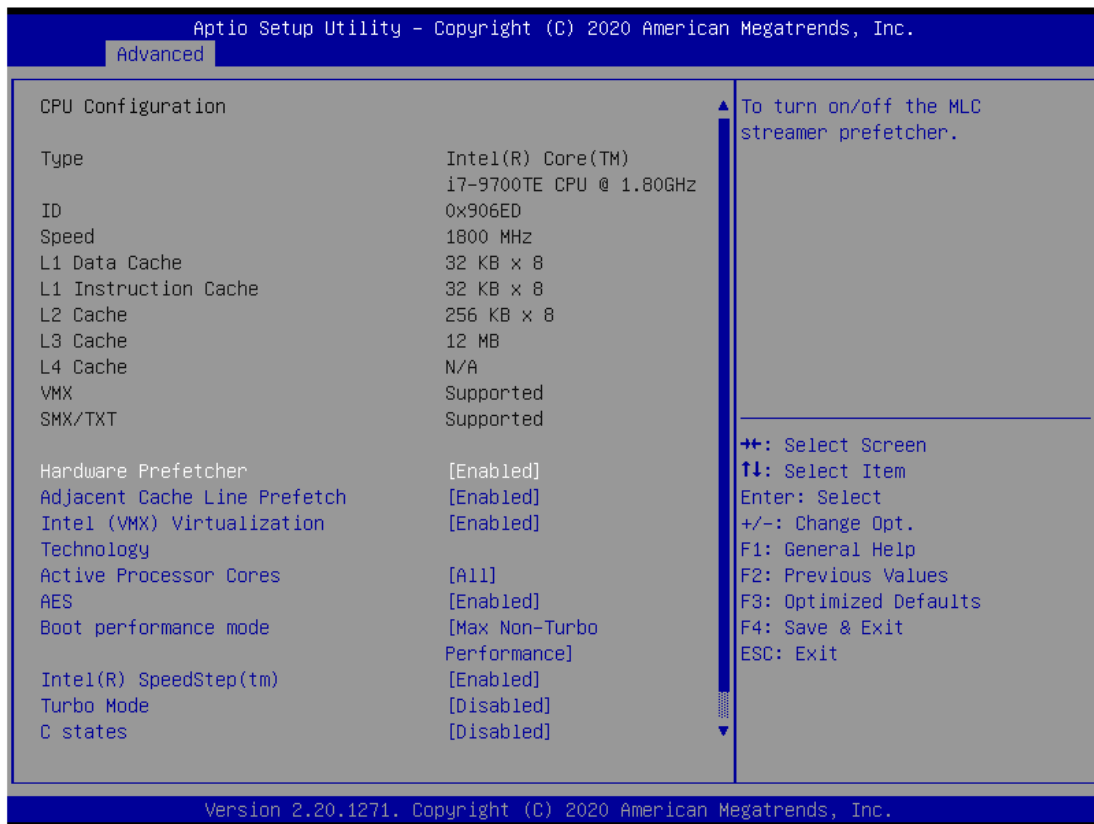

- **Intel Virtualization Technology**

This item allows a hardware platform to run multiple operating systems separately and simultaneously, enabling one system to virtually function as several systems.

● **SATA and RST Configuration**

You can read the current installed hardware configurations from those SATA ports in the SATA and RST Configuration menu. During system boot up, BIOS will detect the present SATA devices automatically.

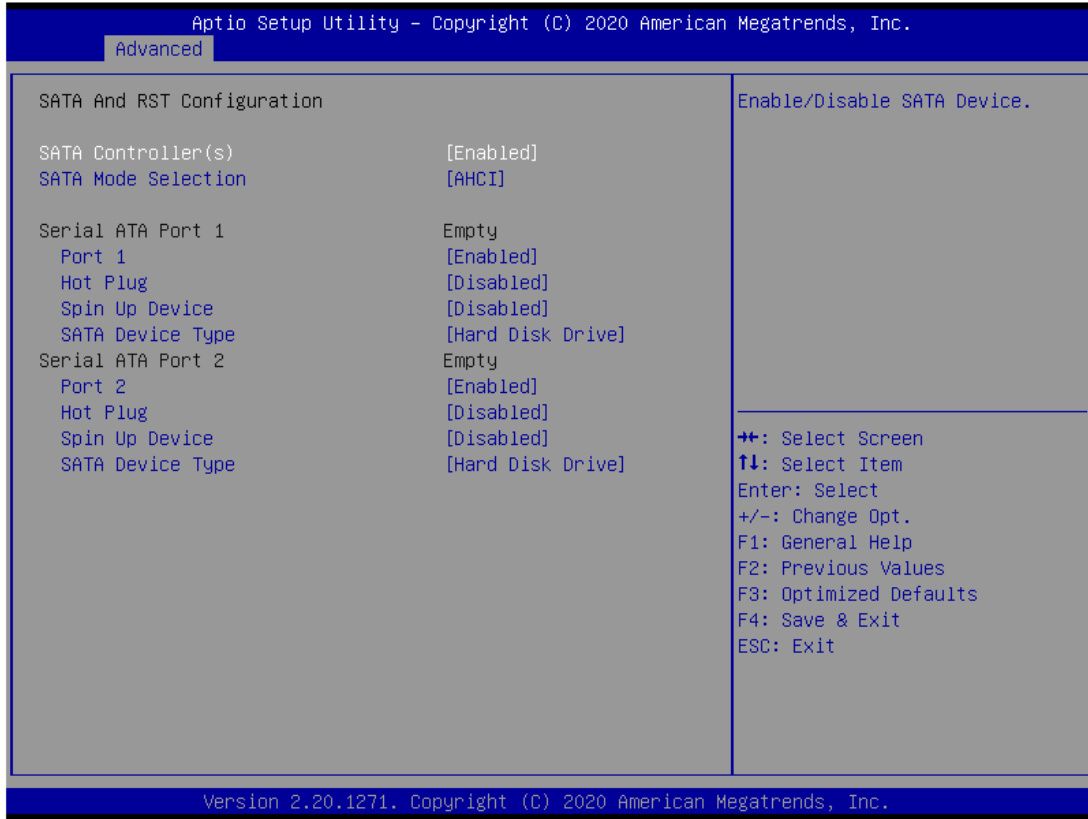

- **AMT Configuration**



● **USB Configuration**

USB configuration can be configured here by selecting and changing each item. A description of the selected item appears on the right side of the screen.

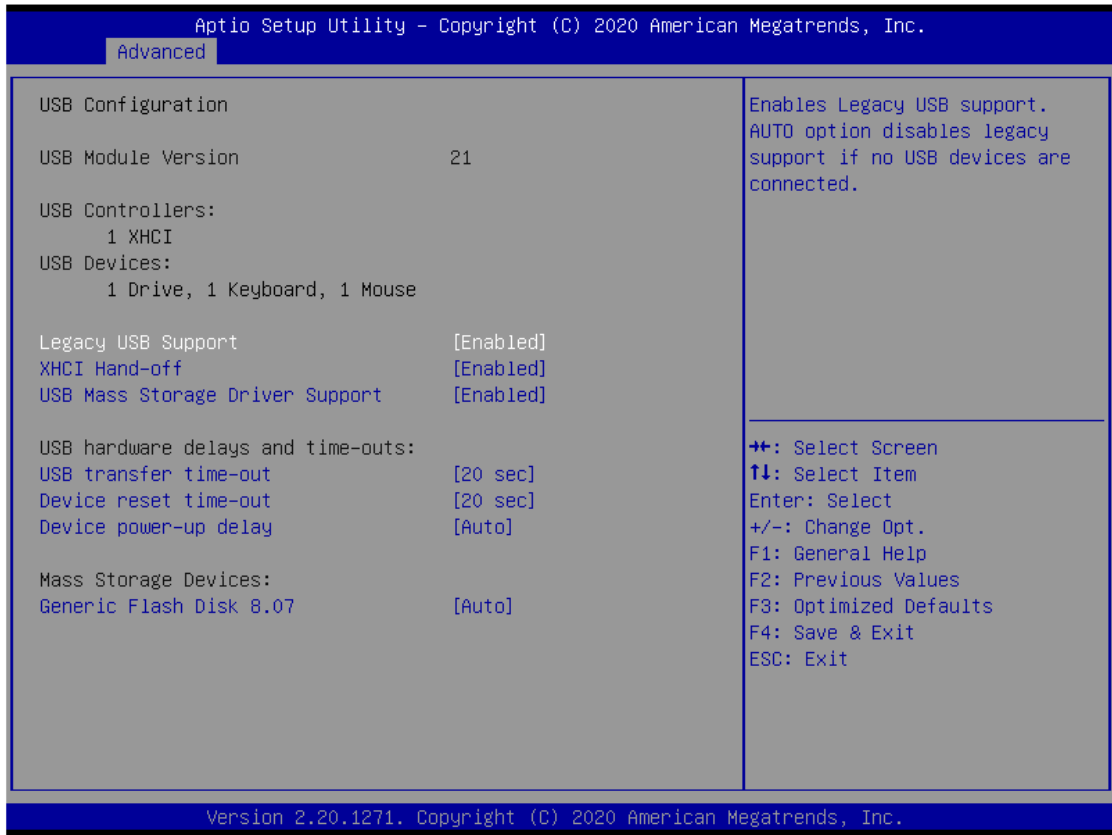

➤ **USB Devices**

Display all detected USB devices.

- **F81803 Super IO Configuration**

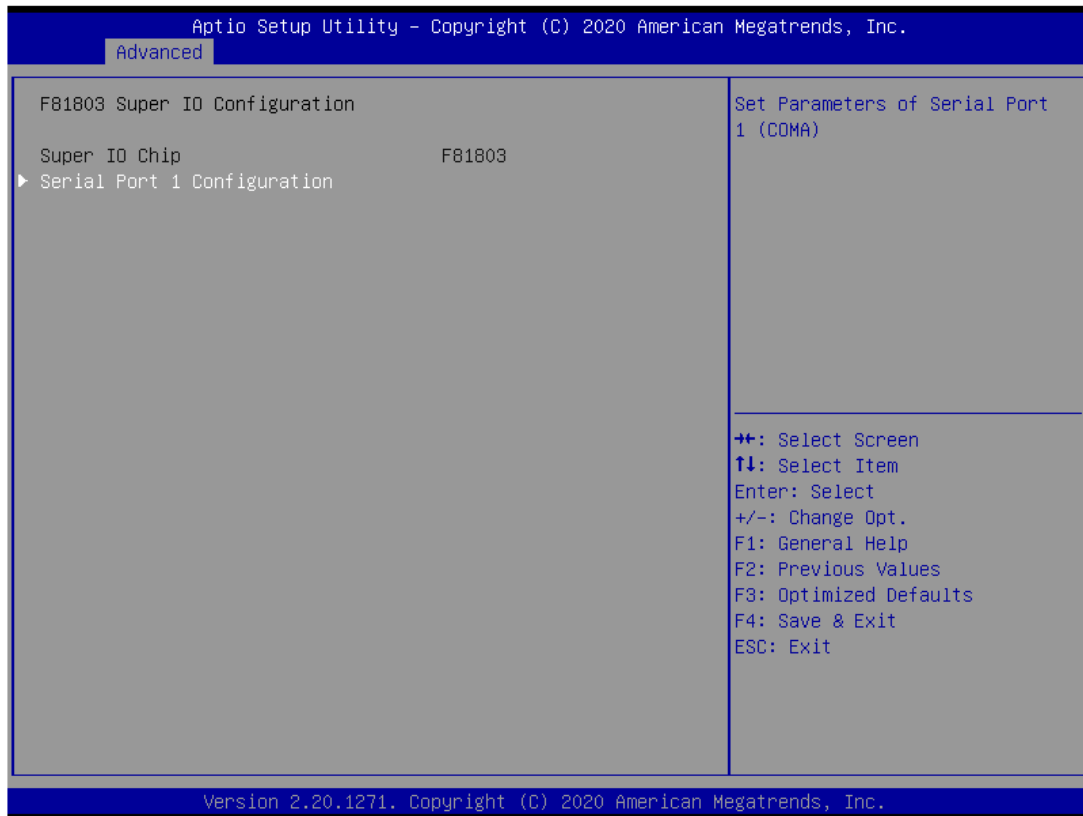

- **Serial Port 1~4 Configuration**

Use this item to set parameters of serial port 1 to 4.

- **Serial Port (1~4) Console**

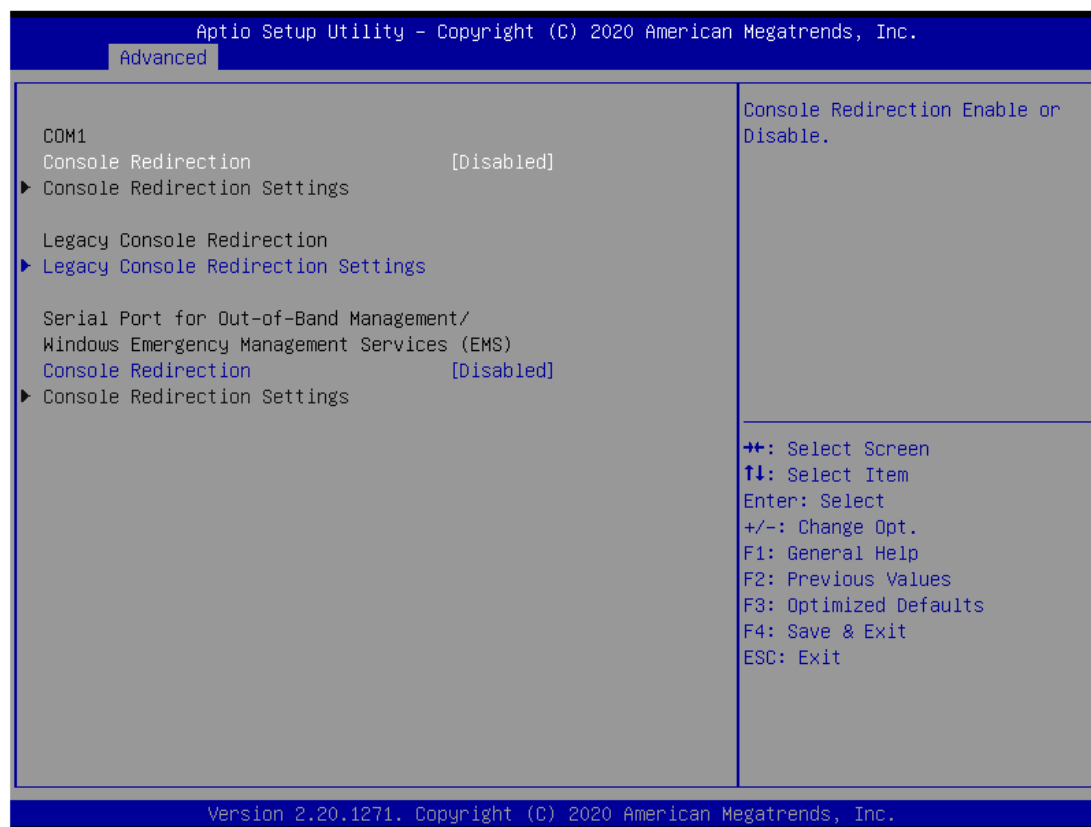

- **COM Port Type**

Use this item to set parameters of RS232/422/485.



● **Compatibility Support Module (CSM) Configuration**

Aptio Setup Utility - Copyright (C) 2020 American Megatrends, Inc.

Advanced

Compatibility Support Module Configuration		Enable/Disable CSM Support.
CSM Support	[Enabled]	
CSM16 Module Version	07.82	
GateA20 Active	[Upon Request]	
Option ROM Messages	[Force BIOS]	
INT19 Trap Response	[Immediate]	
HDD Connection Order	[Adjust]	
Boot option filter	[UEFI and Legacy]	
Option ROM execution		++: Select Screen ↑↓: Select Item Enter: Select +/-: Change Opt. F1: General Help F2: Previous Values F3: Optimized Defaults F4: Save & Exit ESC: Exit
Launch PXE OpROM policy	[Do not launch]	
Storage	[Legacy]	
Video	[Legacy]	
Other PCI devices	[Legacy]	

Version 2.20.1271. Copyright (C) 2020 American Megatrends, Inc.

● **PCI Subsystem Setting**

The screenshot displays the BIOS setup utility interface. At the top, a blue header bar contains the text "Aptio Setup Utility - Copyright (C) 2020 American Megatrends, Inc." and a sub-menu "Advanced" is highlighted. The main content area is divided into two columns. The left column, titled "PCI Subsystem Settings", lists "PCI Settings Common for all Devices:" with two entries: "PCI Latency Timer" set to "[32 PCI Bus Clocks]" and "VGA Palette Snoop" set to "[Disabled]". The right column contains a description: "Value to be programmed into PCI Latency Timer Register." Below this, a legend lists navigation keys: "++: Select Screen", "↑↓: Select Item", "Enter: Select", "+/-: Change Opt.", "F1: General Help", "F2: Previous Values", "F3: Optimized Defaults", "F4: Save & Exit", and "ESC: Exit". A footer bar at the bottom of the window reads "Version 2.20.1271. Copyright (C) 2020 American Megatrends, Inc."

## 3.5 Chipset Menu

The Chipset menu allows users to change the advanced chipset settings. You can select any of the items in the left frame of the screen to go to the sub menus:

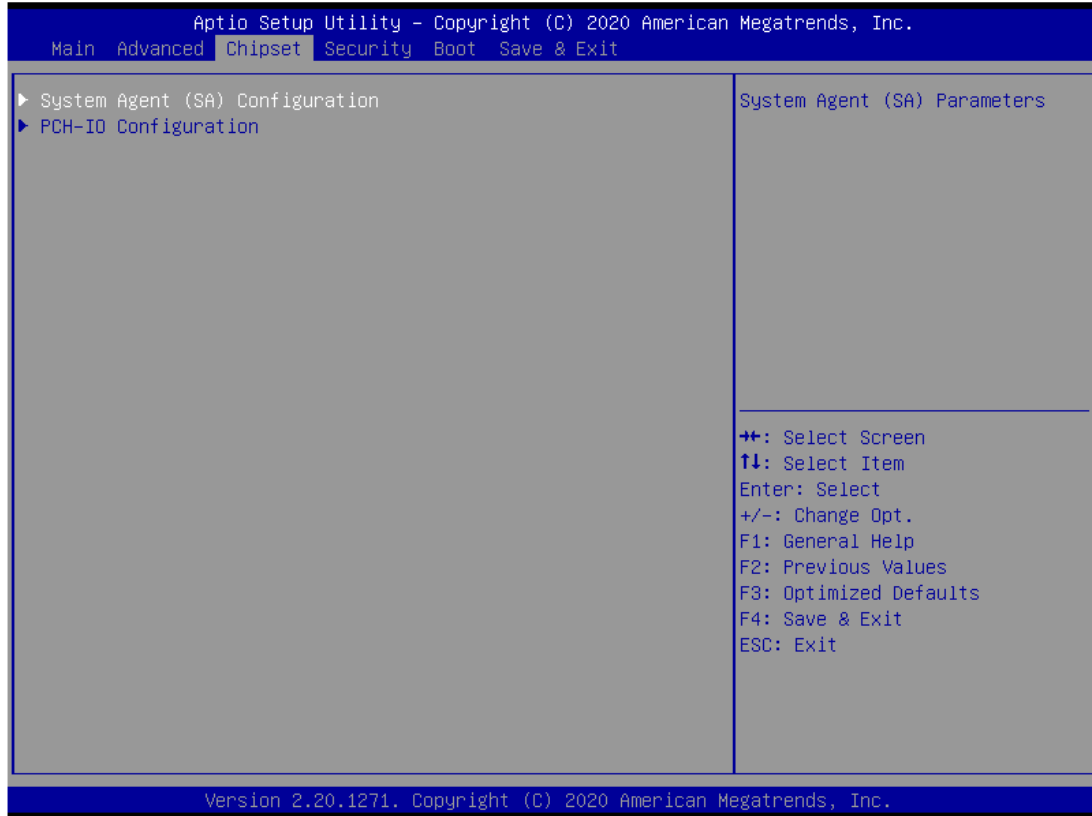

► **System Agent (SA) Configuration**

For items marked with “►”, please press <Enter> for more options.

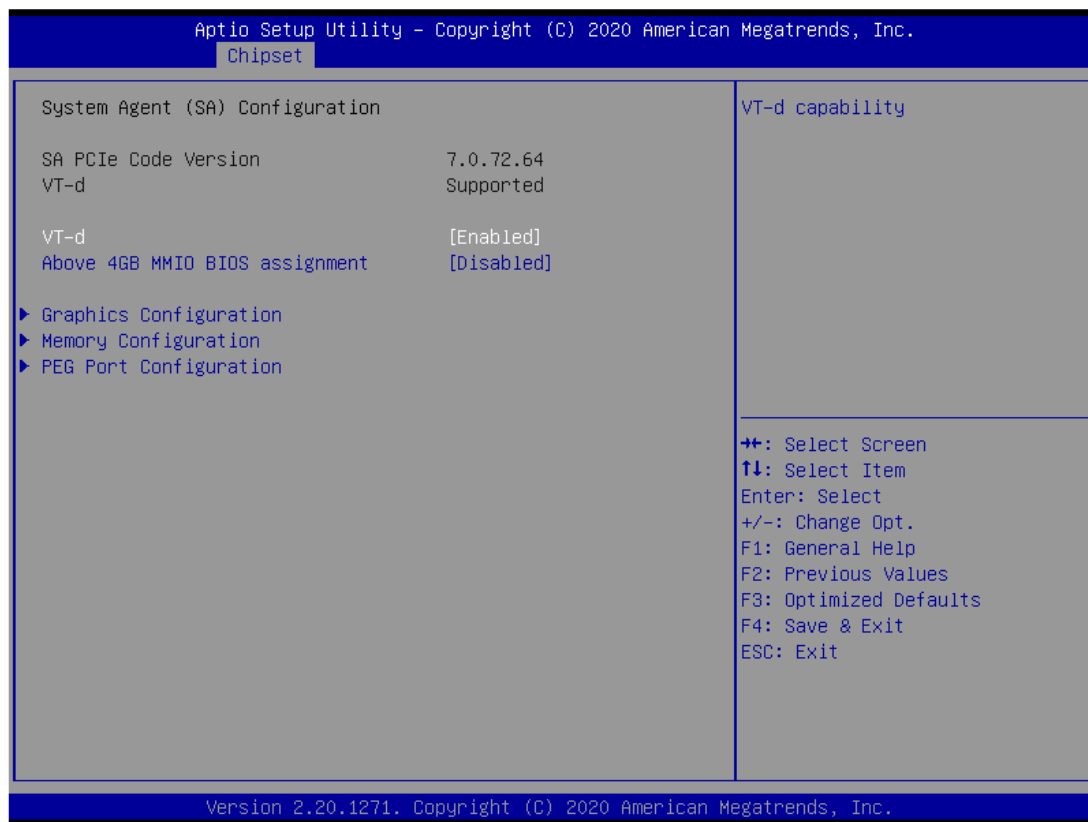

● **PEG Port Configuration**

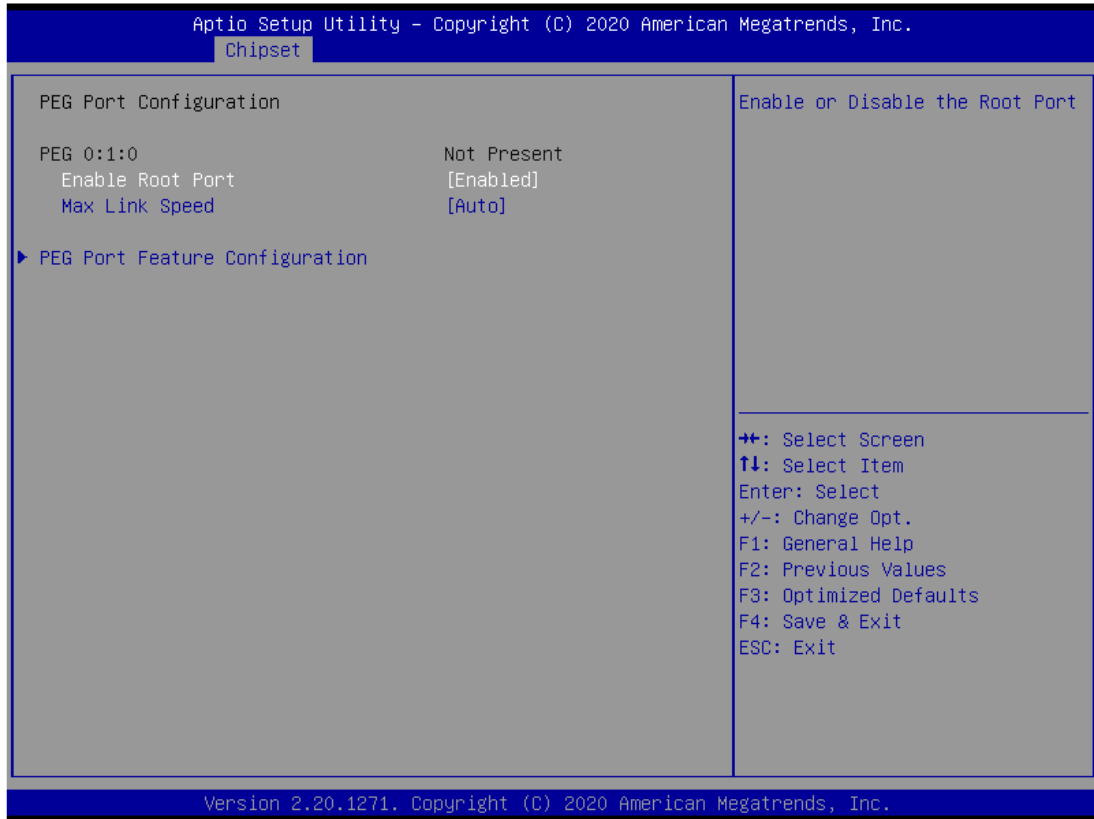

● **PEG Port Feature Configuration**

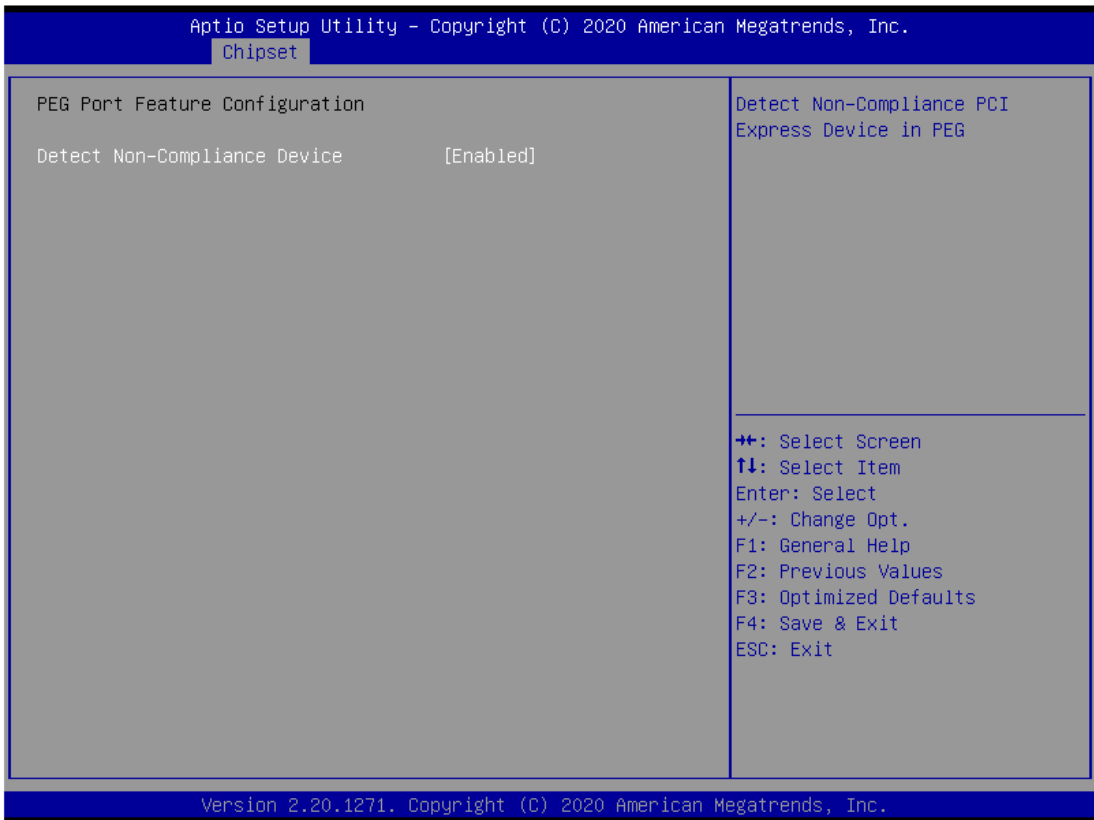

- **Graphics Configuration**

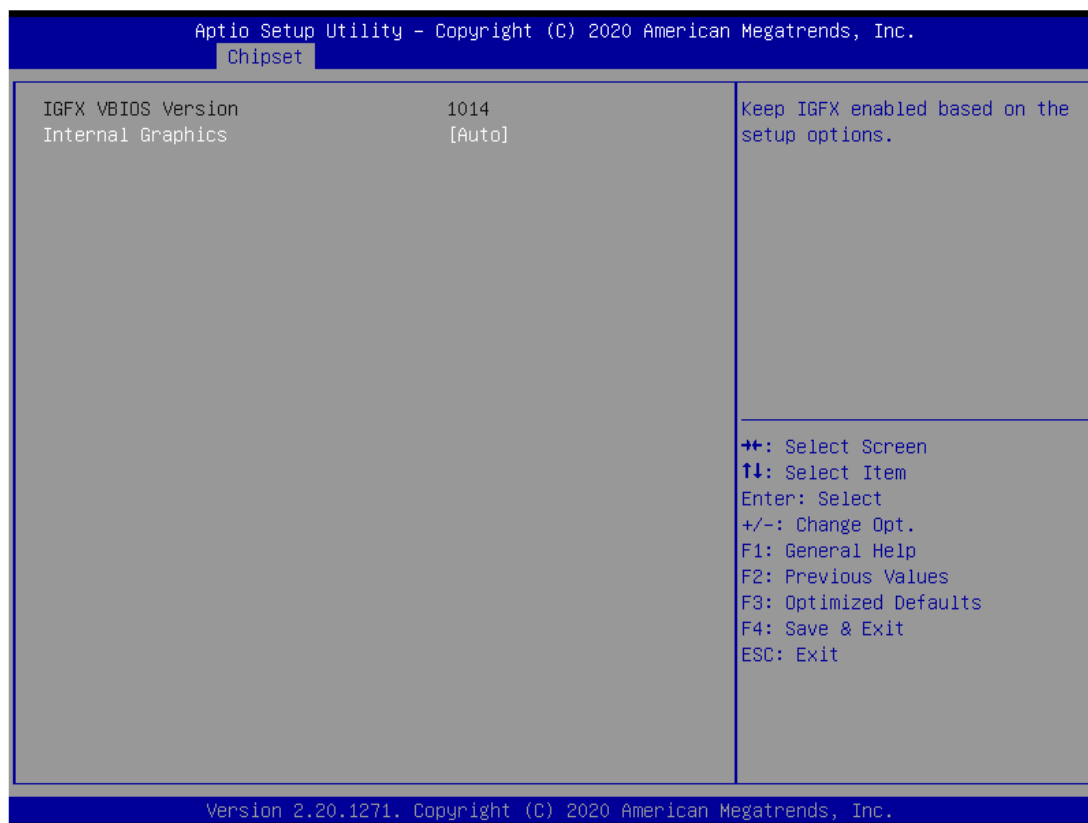

- **Display Select**

Allows you to select which graphics controller to use as the primary boot device.

- **Memory Configuration**

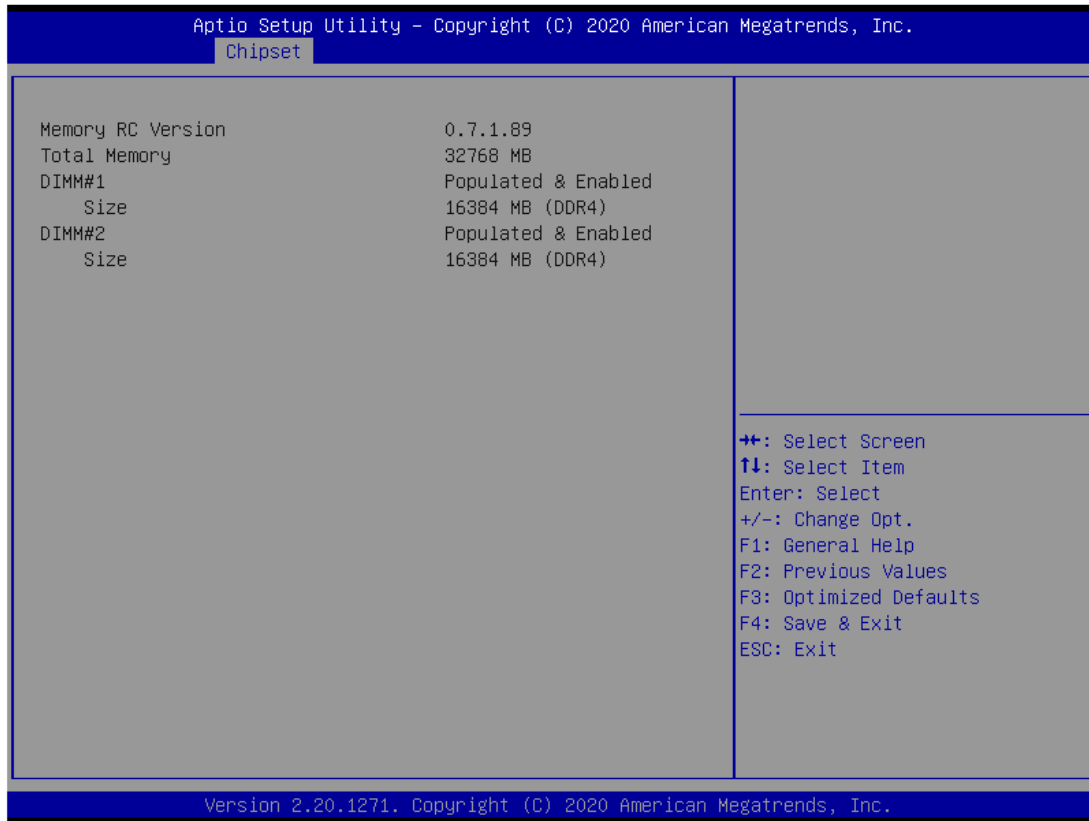

### 3.6 Security Menu

The Security menu allows users to change the security settings for the system.

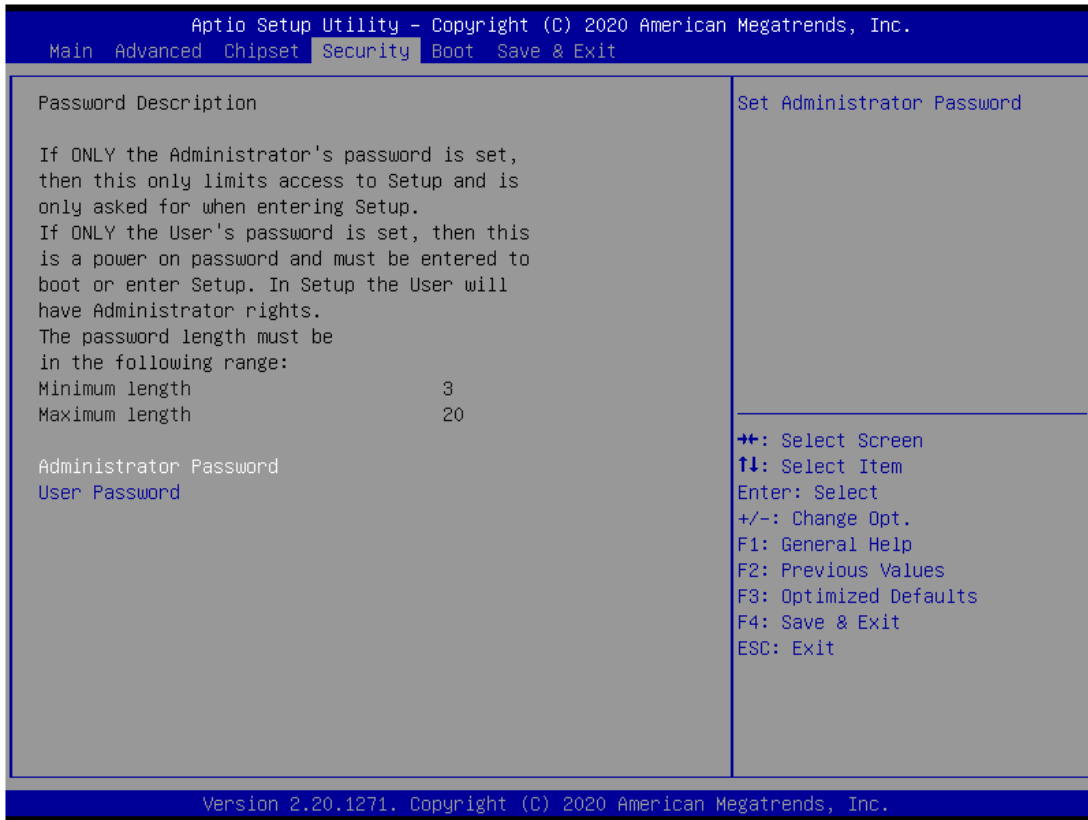

➤ **Administrator Password**

This item indicates whether an administrator password has been set (installed or uninstalled).

➤ **User Password**

This item indicates whether an user password has been set (installed or uninstalled).



### 3.7 Boot Menu

The Boot menu allows users to change boot options of the system.

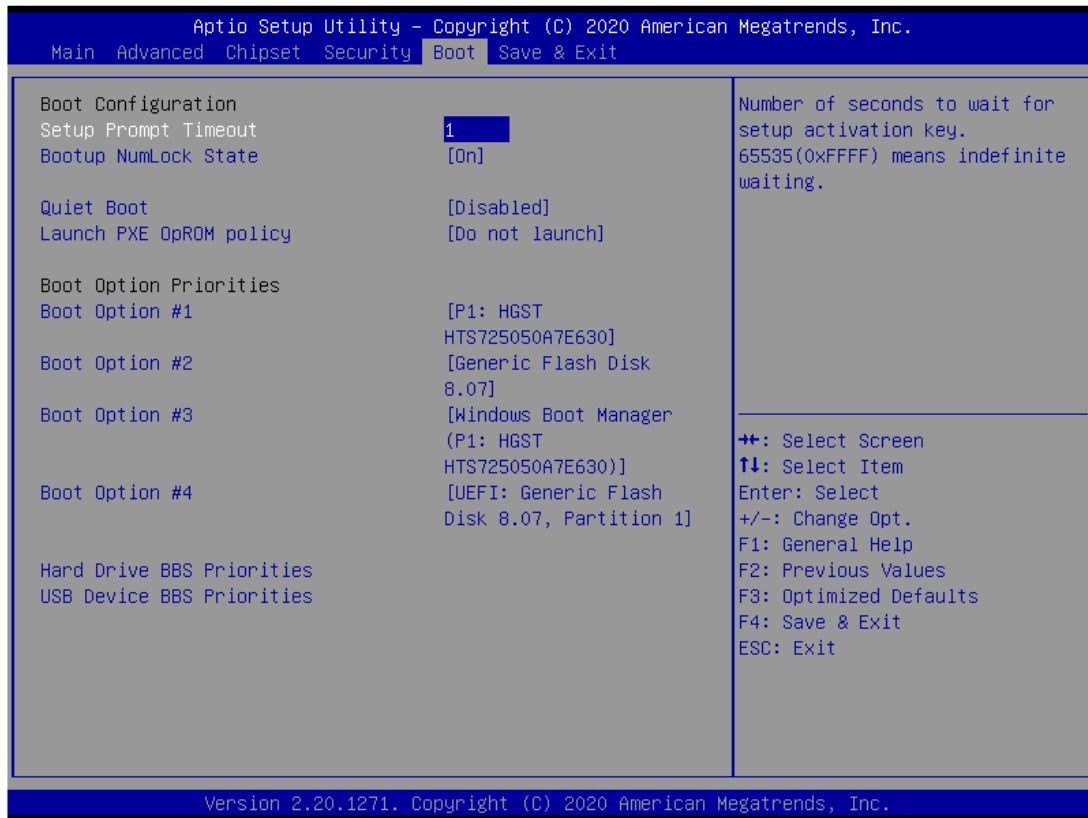

- **Setup Prompt Timeout**  
Set the number of seconds to wait for setup activation key. 65535(0xFFFF) means indefinite waiting.
- **Bootup NumLock State**  
Use this item to select the power-on state for the keyboard NumLock.
- **Quiet Boot**  
Select to display either POST output messages or a splash screen during boot-up.
- **Launch PXE OpROM policy**  
Use this item to enable or disable the boot ROM function of the onboard LAN chip when the system boots up.
- **Boot Option Priorities**  
These are settings for boot priority. Specify the boot device priority sequence from the available devices.

### 3.8 Save & Exit Menu

The Save & Exit menu allows users to load your system configuration with optimal or fail-safe default values.

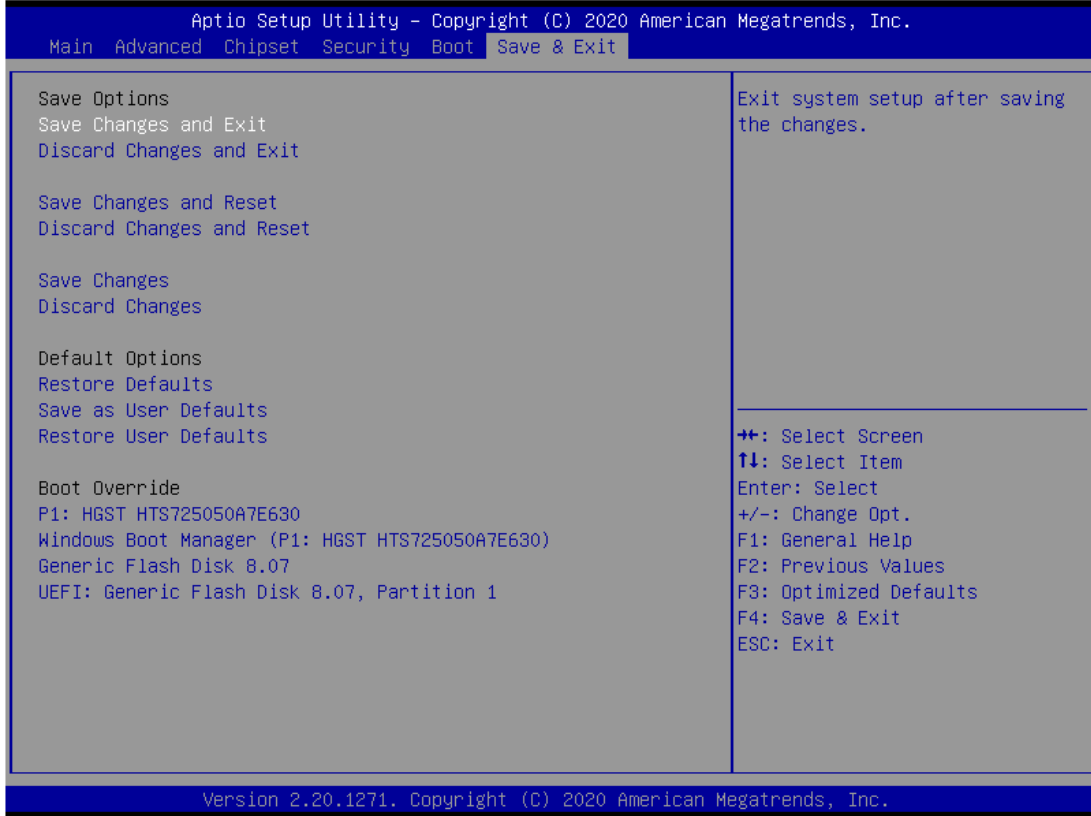

➤ **Save Changes and Exit**

When finishing the system configuration settings, select this option to leave Setup and return to Main Menu. Select Save Changes and Exit from the Save & Exit menu and press <Enter>. Select Yes to save changes and exit.

➤ **Discard Changes and Exit**

Select this option to quit Setup without making any permanent changes to the system configuration and return to Main Menu. Select Discard Changes and Exit from the Save & Exit menu and press <Enter>. Select Yes to discard changes and exit.

➤ **Save Changes and Reset**

When finishing the system configuration settings, select this option to leave Setup and reboot the computer so the new system configuration parameters can take effect. Select Save Changes and Reset from the Save & Exit menu and press <Enter>. Select Yes to save changes and reset.

➤ **Discard Changes and Reset**

Select this option to quit Setup without making any permanent changes to the system configuration and reboot the computer. Select Discard Changes and Reset from the Save & Exit menu and press <Enter>. Select Yes to discard changes and reset.

➤ **Save Changes**

When finishing the system configuration settings, select this option to save changes. Select Save Changes from the Save & Exit menu and press <Enter>. Select Yes to save changes.

➤ **Discard Changes**

Select this option to quit Setup without making any permanent changes to the system configuration. Select Discard Changes from the Save & Exit menu and press <Enter>. Select Yes to discard changes.

➤ **Restore Defaults**

After selecting this option, all the settings will be restored to defaults automatically. Select Restore Defaults from the Save & Exit menu and press <Enter>.

➤ **Save as User Defaults**

Select this option to save your current system configuration settings as User Defaults. Select Save as User Defaults from the Save & Exit menu and press <Enter>.

➤ **Restore User Defaults**

After selecting this option, all the settings will be restored to user defaults automatically. Select Restore User Defaults from the Save & Exit menu and press <Enter>.

➤ **Boot Override**

Select a drive to immediately boot that device regardless of the current boot order.

**This page is intentionally left blank.**

## APPENDIX A WATCHDOG TIMER

### A.1 About Watchdog Timer

Software stability is a major issue in most applications. Some embedded systems are not watched by an operator for 24 hours. It is usually too late to wait for someone to reboot when computer hangs. The systems need to be able to reset automatically when things go wrong. The watchdog timer gives us a solution in this regard.

The watchdog timer is a counter that triggers a system reset when it counts down to zero from a preset value. The software starts the counter with an initial value and must reset it periodically. If the counter ever reaches zero which means the software has crashed, the system will reboot.

### A.2 How to Use Watchdog Timer

The I/O port base addresses of watchdog timer are 2E (hex) and 2F (hex). The 2E (hex) and 2F (hex) are address and data port respectively.

Assume that program A is put in a loop that must execute at least once every 10ms. Initialize watchdog timer with a value bigger than 10ms. If the software has no problems, watchdog timer will never expire because software will always restart the counter before it reaches zero.

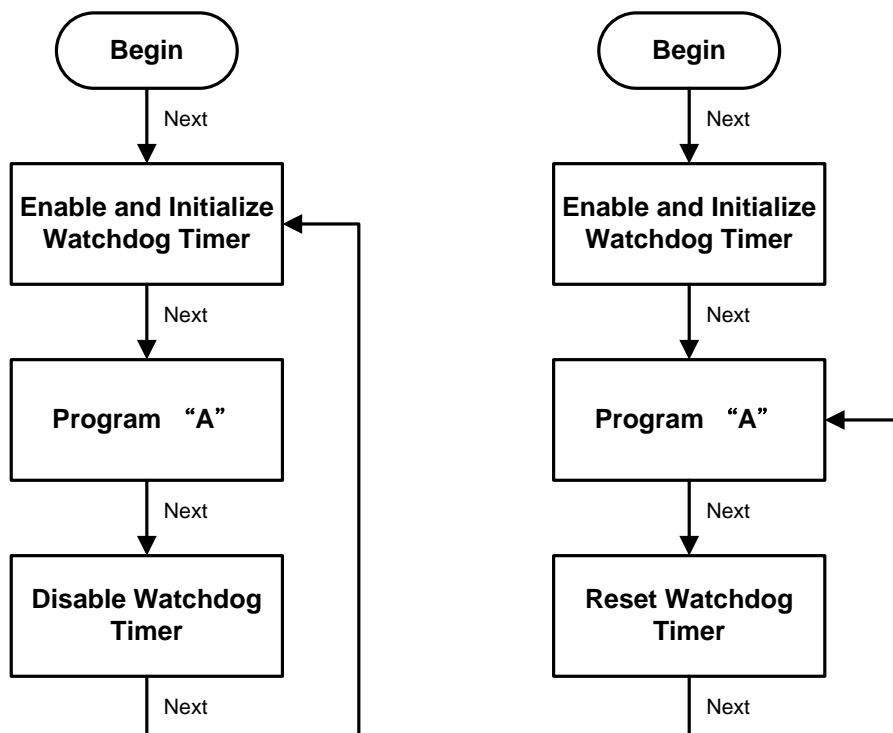

## A.3 Sample Program

Assembly sample code:

```
;Enable WDT:
mov    dx,2Eh
mov    al,87          ;Un-lock super I/O
out    dx,al
out    dx,al
```

```
;Select Logic device:
```

```
mov    dx,2Eh
mov    al,07h
out    dx,al
mov    dx,2Fh
mov    al,07h
out    dx,al
```

```
;Enable WDT base address:
```

```
mov    dx,2Eh
mov    al,30h
out    dx,al
mov    dx,2Fh
mov    al,01h
out    dx,al
```

```
;Activate WDT:
```

```
mov    dx,2Eh
mov    al,0F0h
out    dx,al
mov    dx,2Fh
mov    al,80h
out    dx,al
```

```
;Set base timer :
```

```
mov    dx,2Eh
mov    al,0F6h
```

```

out    dx,a1
mov    dx,2Fh
mov    a1,Mh          ;M=00h,01h,...FFh (hex),value=0 to 255
out    dx,a1          ;(see  Note below)

```

;Set Second or Minute :

```

mov    dx,2Eh
mov    a1,0F5h
out    dx,a1
mov    dx,2Fh
mov    a1,Nh          ;N=71h or 79h(see  Note below)
out    dx,a1

```

 **Note:**

If **N=71h**, the time base is set to second.

**M** = time value

00: Time-out disable

01: Time-out occurs after 1 second

02: Time-out occurs after 2 seconds

03: Time-out occurs after 3 seconds

.

.

FFh: Time-out occurs after 255 seconds

If **N=79h**, the time base is set to minute.

**M** = time value

00: Time-out disable

01: Time-out occurs after 1 minute

02: Time-out occurs after 2 minutes

03: Time-out occurs after 3 minutes

.

.

FFh: Time-out occurs after 255 minutes

**This page is intentionally left blank.**



## APPENDIX B CONFIGURING SATA FOR RAID

### Configuring SATA Hard Drive(s) for RAID (Controller: Intel® Q370)

Before you begin the SATA configuration, please prepare four SATA hard drives (to ensure optimal performance, it is recommended that you use two hard drives with the identical model and capacity). If you do not want to create RAID with the SATA controller, you may prepare only one hard drive.

**Please follow the steps below to configure SATA hard drive(s):**

1. Install SATA hard drive(s) in your system.
2. Enter the BIOS Setup to configure SATA controller mode and boot sequence.
3. Configure RAID using the RAID BIOS.

#### 1. Installing SATA hard drive(s) in your system.

Connect one end of the SATA signal cable to the rear of the SATA hard drive, and the other end to an available SATA port on the board. Then, connect the power connector of power supply to the hard drive.

#### 2. Configuring SATA controller mode and boot sequence by the BIOS Setup.

You have to make sure whether the SATA controller is configured correctly by system BIOS Setup and then set up BIOS boot sequence for the SATA hard drive(s).

- 2.1. Turn on your system, and then press the <Del> button to enter BIOS Setup during the process of running POST (Power-On Self-Test). If you want to create RAID, just go to the Advanced Settings menu\SATA Configuration, select the "SATA Mode Selection", and press <Enter> for more options.

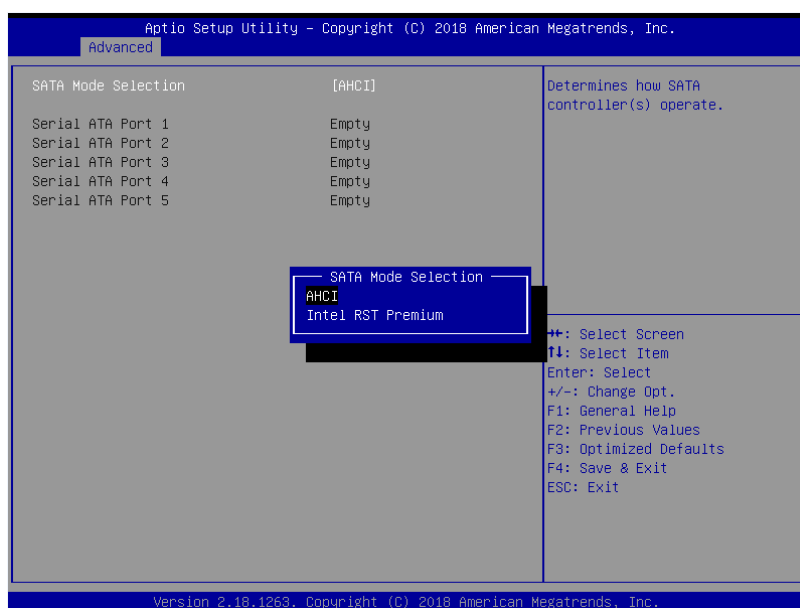

A list of options appears. Please select "Intel RST Premium".

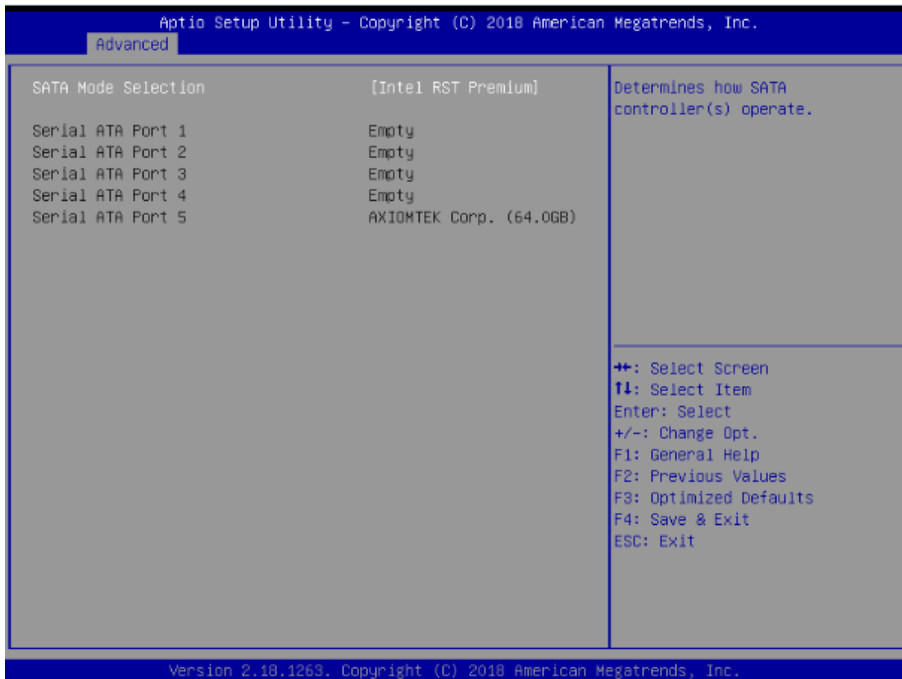

2.2. Save and exit the BIOS Setup.

### 3. Configuring RAID by the RAID BIOS.

Enter the RAID BIOS setup utility to configure a RAID array. Skip this step and proceed if you do not want to create a RAID.

3.1. After the POST memory testing and before the operating system booting, a message "Press <Ctrl-I> to enter Configuration Utility" shows up. Press <Ctrl + I> to enter the RAID BIOS setup utility.

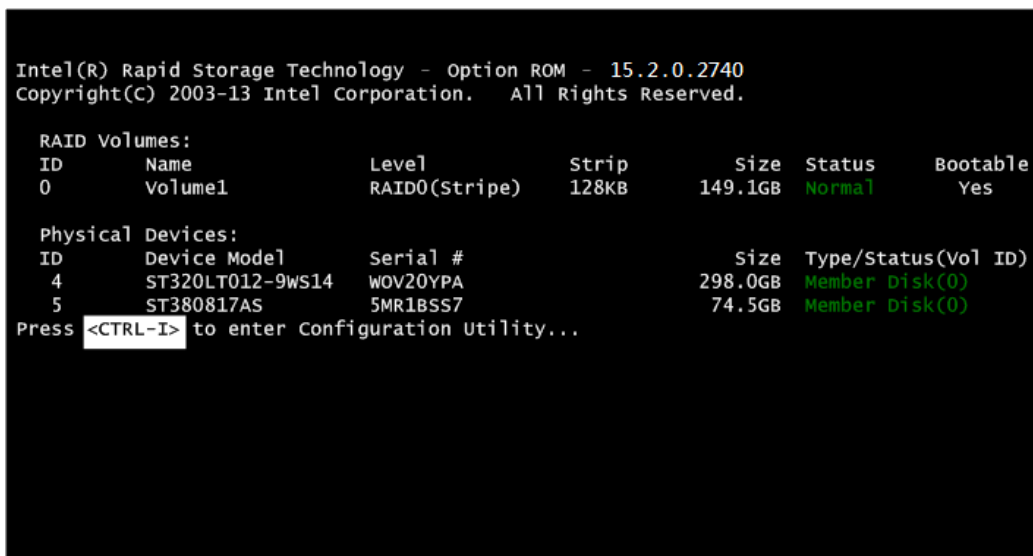

3.2. After you press <Ctrl + I>, the Create RAID Volume screen will appear. If you want to create a RAID array, select the Create RAID Volume option in the Main Menu and press <Enter>.

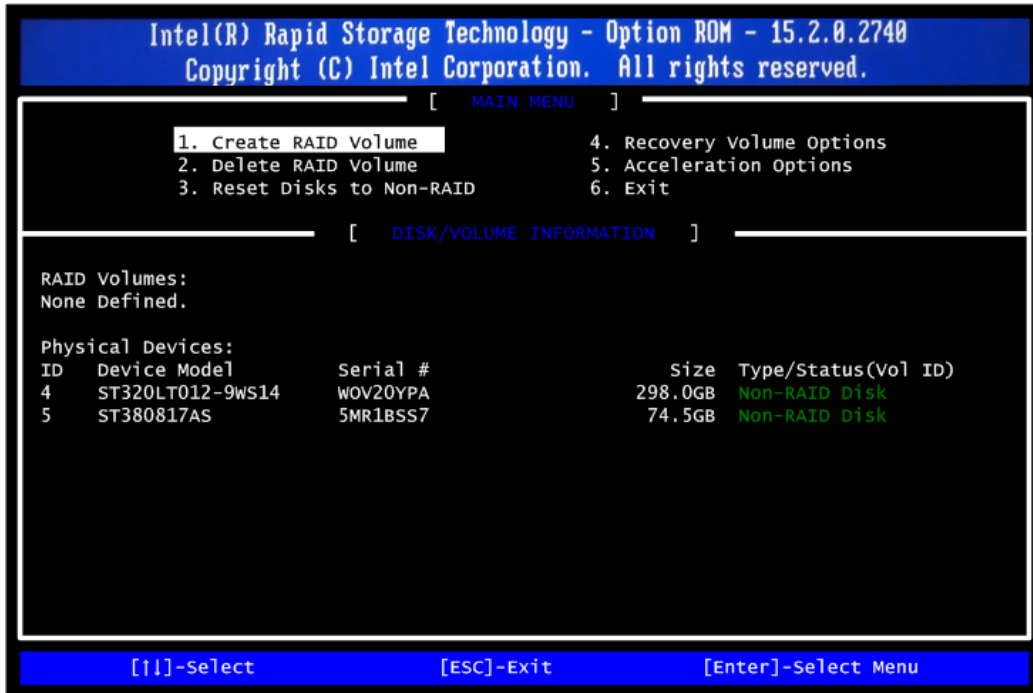

- 3.3. After entering the Create Volume Menu screen, you can type the disk array name with 1~16 letters (letters cannot be special characters) in the item "Name:".

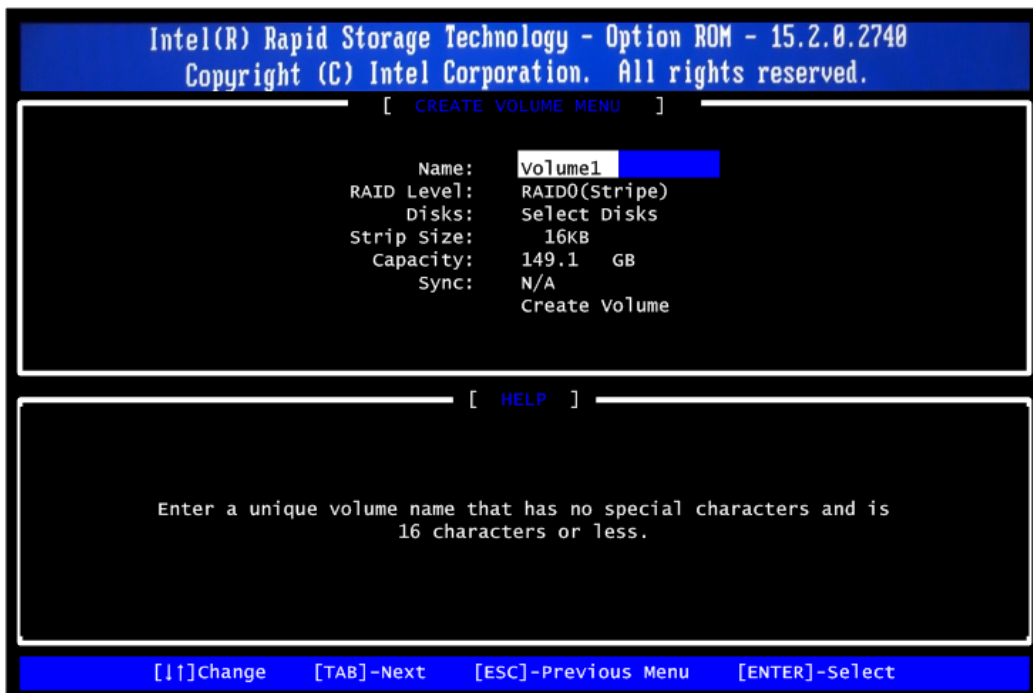

- 3.4. When finished, press <Enter> to select a RAID level. There are two RAID levels: RAID0, RAID1. Select a RAID level and press <Enter>.

Note: eBOX671-517 supports RAID0, RAID1 Only.

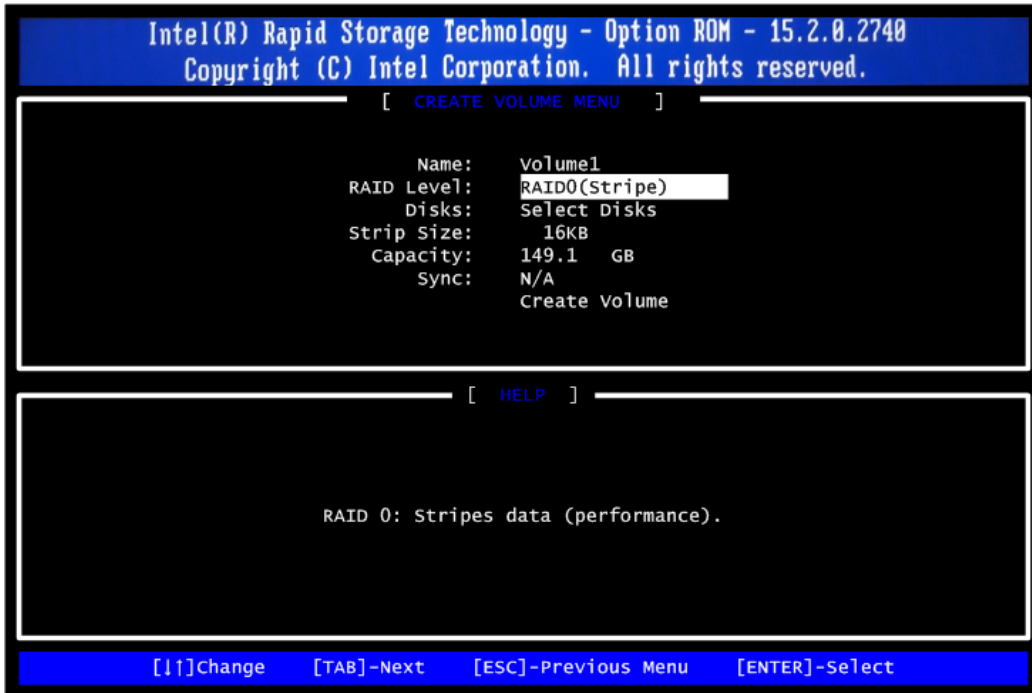

3.5. Set the stripe block size. The KB is the standard unit of stripe block size. The stripe block size can be 4KB to 128KB. After the setting, press <Enter> for the array capacity.



3.6. After setting all the items on the menu, select Create Volume and press <Enter> to start creating the RAID array.

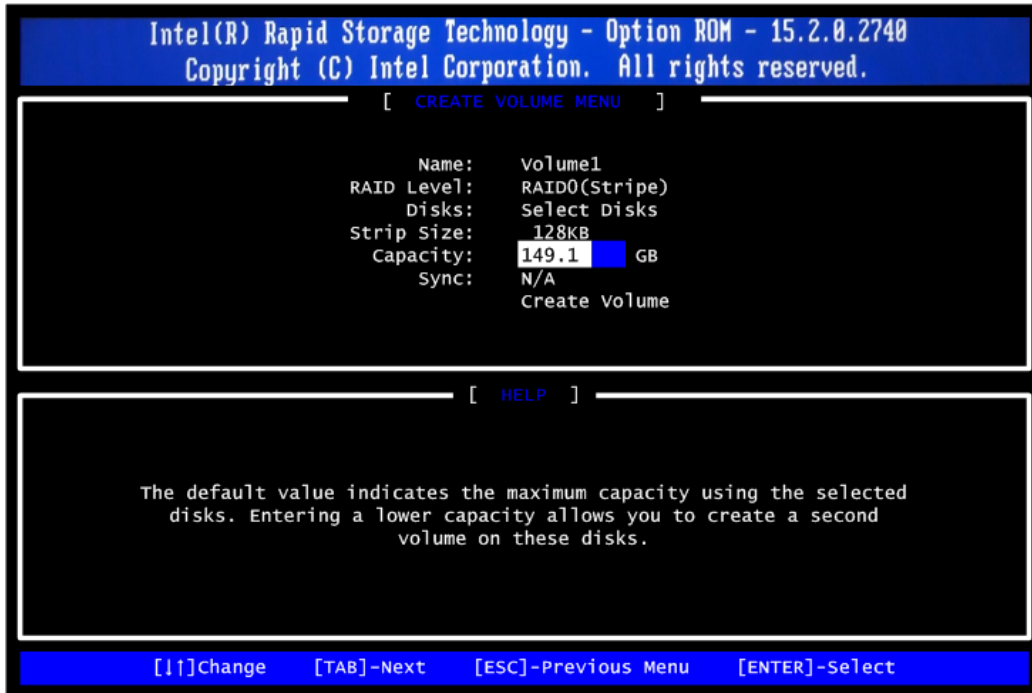

3.7. When prompting for confirmation, press <Y> to create this volume, or <N> to cancel the creation.

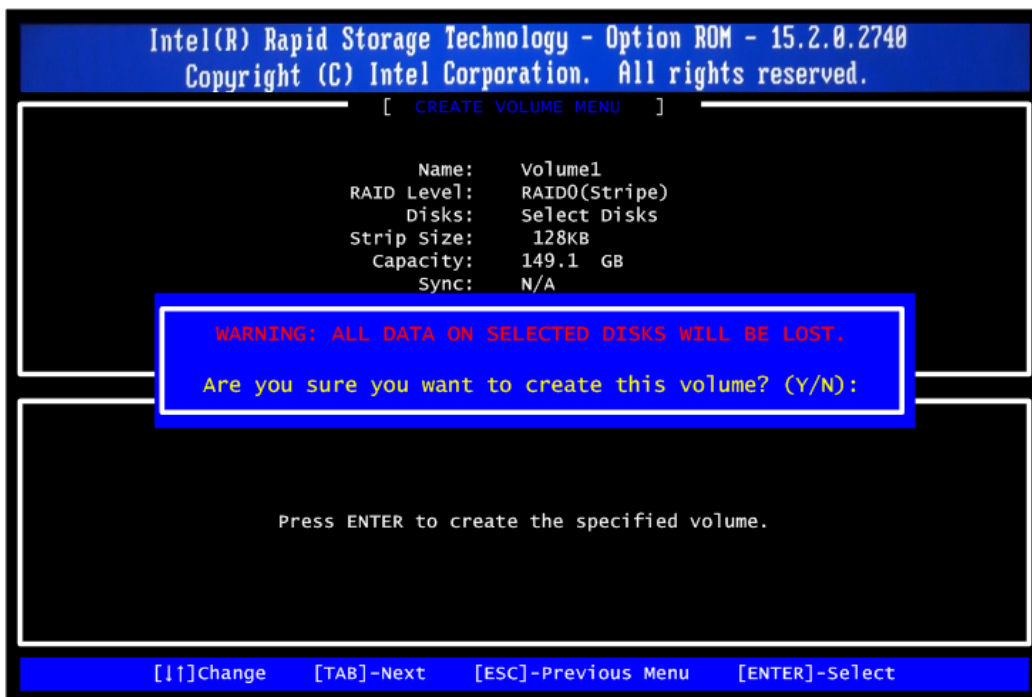

After the creation is complete, you will see detailed information about the RAID array in the Disk/Volume Information section, including RAID mode, disk block size, disk name, disk capacity, etc.

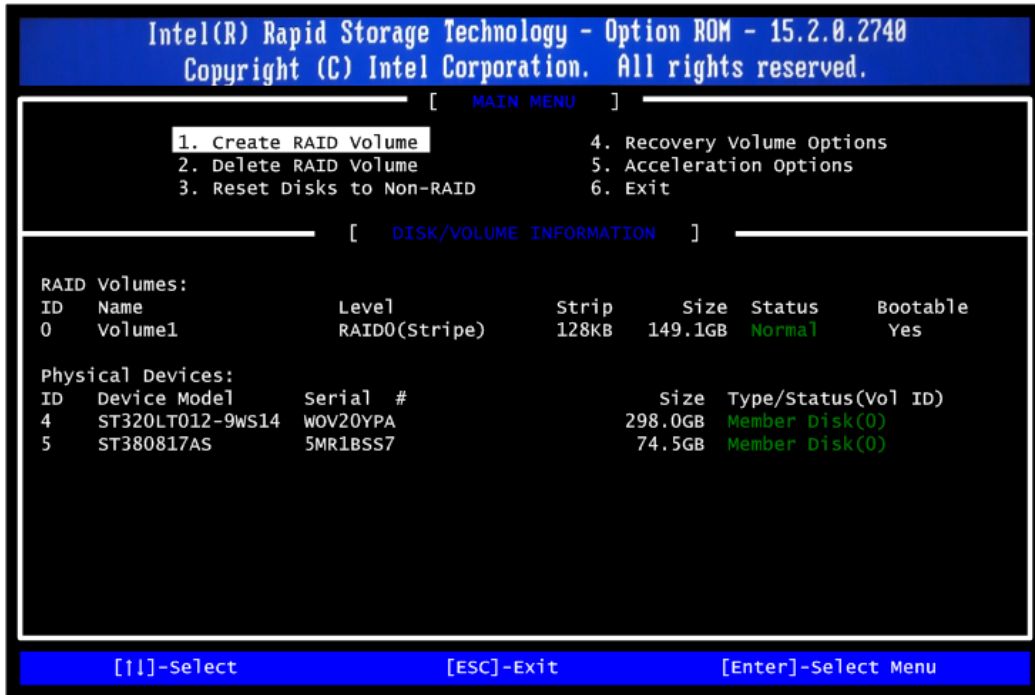

### Delete RAID volume

If you want to delete a RAID volume, select the Delete RAID Volume option in Main Menu. Press <Enter> and follow on-screen instructions.

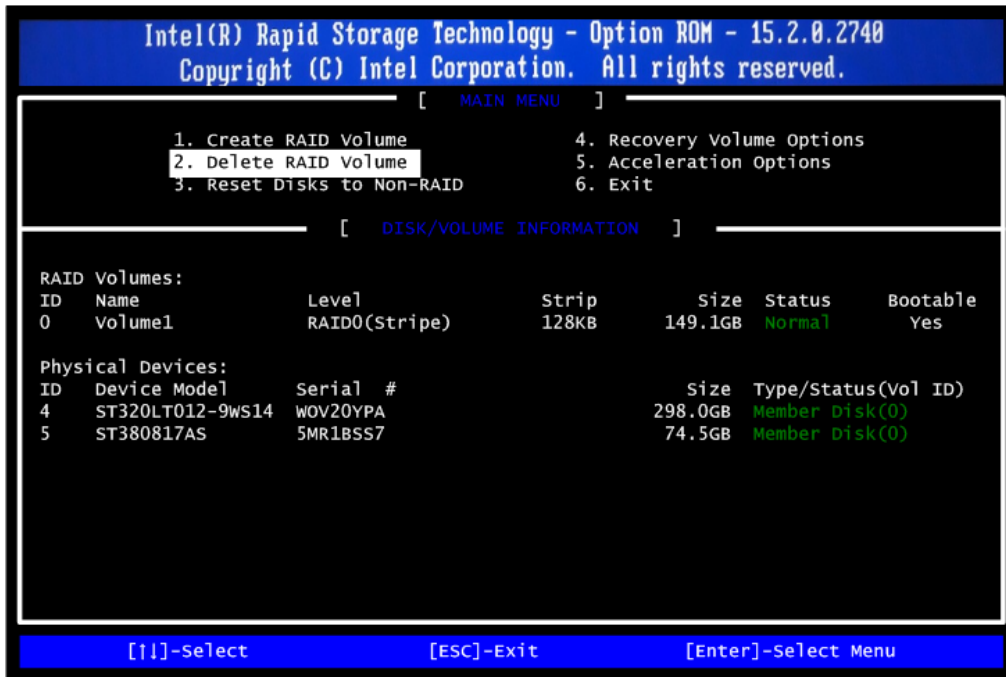

Please press <Esc> to exit the RAID BIOS utility. Now, you can proceed to install a SATA driver controller and the operating system.