

USER'S MANUAL

GOT318W-521-PCT

**All-in-One
18.5" FHD TFT Fanless
PCT Multi-Touch Panel PC**

User's Manual



www.axiomtek.com

Disclaimers

This manual has been carefully checked and believed to contain accurate information. Axiomtek Co., Ltd. assumes no responsibility for any infringements of patents or any third party's rights, or any liability arising from such uses.

Axiomtek does not warrant or assume any legal liability or responsibility for the accuracy, completeness or usefulness of any information in this document. Axiomtek does not make any commitment to update any information in this manual.

Axiomtek reserves the right to change or revise this document and/or product at any time without notice.

No part of this document may be reproduced, stored in a retrieval system, or transmitted in any forms or by any means, electronic, mechanical, photocopying, recording, among others, without prior written permission from Axiomtek Co., Ltd.



WARNING

- *Replacing the battery with an incorrect model may cause an explosion. Only use the same or equivalent type of battery as recommended by the manufacturer.*
- *Properly dispose of used batteries according to the instructions.*

©Copyright 2022 Axiomtek Co., Ltd.

All Rights Reserved

January 2022, Version A2

Printed in Taiwan

Safety Precautions

Before getting started, please read the following important safety precautions.

1. Be sure to ground yourself to prevent static charge when installing any internal components. Use a grounding wrist strap and place all electronic components in any static-shielded devices. Most electronic components are sensitive to static electrical charge.
2. Disconnect the power cord from the GOT318W-521-PCT prior to any installation. Be sure both the system and all external devices are turned off. Sudden surge of power could ruin sensitive components. Make sure the GOT318W-521-PCT series is properly grounded.
3. Make sure the voltage of the power source is correct before connecting the GOT318W-521-PCT to any power outlet.
4. Turn off system power before cleaning. Clean the system using a cloth only. Do not spray any liquid cleaner directly onto the screen.
5. Do not open the system's back cover. If opening the cover for maintenance is a must, only a trained technician is allowed to do so. Integrated circuits on computer boards are sensitive to static electricity. To avoid damaging chips from electrostatic discharge, observe the following precautions:
 - Before handling a board or integrated circuit, touch an unpainted portion of the system unit chassis for a few seconds. This will help to discharge any static electricity on human body.
 - When handling boards and components, wear a grounding wrist strap available from most electronic component stores.

Trademark Acknowledgments

Axiomtek is a trademark of Axiomtek Co., Ltd.

Intel® and Pentium® are registered trademarks of Intel Corporation.

Windows 10 and Windows 10 IoT Enterprise are trademarks of Microsoft Corporation.

Other brand names and trademarks are the properties and registered brands of their respective owners.

Table of Contents

Disclaimers.....	ii
Safety Precautions.....	iii
SECTION 1 INTRODUCTION	1
1.1.....	General Descriptions
1	
1.2.....	Specifications
2	
1.3.....	Dimensions and Outlines
4	
1.4.....	I/O Outlets
6	
1.5.....	Packing List
7	
SECTION 2	HARDWARE INSTALLATION
9	
2.1.....	Open Back Cover
9	
2.2.....	Jumper and Connector Settings
10	
2.2.1 Restore BIOS Optimal Defaults Jumper (JP4).....	10
2.2.2 Auto Power On Jumper (JP6)	11
2.2.3 COM Port Connector.....	11
2.3.....	Ethernet Connector
12	
2.4.....	Mounting the Panel PC
13	
2.4.1 Panel Mount	13
2.4.2 Wall Mount.....	15
2.4.3 VESA Arm Mount.....	17
2.4.4 Desktop Mount	18
2.5.....	Hardware Installation
19	
2.5.1 Installing an HDD	19
2.5.2 Installing DRAM.....	20
2.5.3 Installing a CPU.....	23
2.5.4 Connecting the Power Input.....	25

SECTION 3 AMI BIOS SETUP UTILITY 26

3.1	Starting	
26		
3.2	Navigation Keys	
26		
3.3	Main Menu	
27		
3.4	Advanced Menu	
28		
3.4.1	IT8625 Super IO Configuration	29
3.4.2	Hardware Monitor	31
3.4.3	Trusted Computing	32
3.4.4	ACPI Setting	34
3.4.5	CPU Configuration	35
3.4.6	SATA Configuration	36
3.4.7	PCH-FW Configuration	37
3.4.8	USB Configuration	38
3.5	Chipset Menu	
38		
3.5.1	System Agent (SA) Configuration	38
3.6	Security Menu	
43		
3.7	Boot Menu	
44		
3.8	Save & Exit Menu	
46		

SECTION 4 DRIVER and INSTALLATION 48

4.1	Operating System	
48		
4.1.1	Driver CD Content	48
4.2	Touch Screen	
49		

APPENDIX A WATCHDOG TIMER 50

A.1	About Watchdog Timer	
50		
A.2	Sample Program	
50		

APPENDIX B iAMT SETTINGS 52

B.1	Entering MEBx
52	
B.2	Set and Change Password
52	
B.3	iAMT Settings
54	
B.4	iAMT Web Console
	57

This page is intentionally left blank.

SECTION 1 INTRODUCTION

This section contains general information and detailed specifications of the GOT318W-521-PCT, including the following subsections:

Figure 1-1 Front panel of the GOT318W-521-PCT



- General Descriptions
- Specifications
- Dimensions and Outlines
- I/O Outlets
- Packing List

1.1 General Descriptions

The GOT318W-521-PCT multi-touch panel PC adopts a 18.5-inch FHDTFT LCD with 500nit brightness and supports the LGA1151 socket 8/9th gen Intel® Core™ i7/i5,i3 & Pentium® processor (Tj 100°C) up to 35W, providing excellent computing performance and thermal resistance. This fanless platform is particularly designed for operation under harsh environments including steel refineries, oil pipes, ships, machine makers, and many more. Having the abilities described below surely makes GOT318W-521-PCT the most robust and cost-effective solution.

- **Designed for extended operating temperature range and ingress protection**

The GOT318W-521-PCT's compact industrial design and fanless cooling system allow the panel PC to sustain an extended operating temperature range between 0°C and +50°C, making the system a power-efficient solution. It also features an IP65 front bezel for protection from liquid and dust.

- **Reliable and stable design**

The GOT318W-521-PCT is specifically designed for vibration-prone environments, best for the industrial machinery markets. With a patented anti-vibration design, the GOT318W-521-PCT is able to work in operation mode under 1.0G (10 ~ 500Hz), which has significantly improved system reliability and sustainability.



NOTE *Heavy-vibration may sometimes cause the LCD screen to flash in white color; however, it won't affect the function of the product.*

- **WLAN antenna supported (optional)**

The GOT318W-521-PCT includes two Mini Card slots as an add-on option for connecting to a wireless LAN card under 802.11 a/b/g/n protocols or with other 4G/GPRS applications. These slots also come with three fixed rotational WLAN/WWAN antennas as optional components for wireless network connection.

- **Multi-Touch PCAP touch with 3H surface hardness**

The GOT318W-521-PCT comes with a user friendly multi-PCAP touchscreen display which allows users to operate the panel PC with direct touch. The surface hardness of the touch glass is up to 7H, providing excellent anti-scratch protection.

- **Other features**

The GOT318W-521-PCT features one 260-pin DDR4-2666/2400 SO-DIMM socket to support maximum system memory capacity of up to 32GB, along with one 2.5" wide temperature SATA HDD/SSD for storage needs. It also provides a full set of I/O including RS-232/422/485, USB 2.0, USB 3.0, audio (line-out), HDMI, DP and VGA output, as well as Gigabit Ethernet. This slim panel PC option supports panel mount, wall mount, VESA mount, and desktop stand mount to offer more installation flexibility.

1.2 Specifications

Main CPU Board

- **CPU**
 - LGA1151 socket 8/9th gen Intel® Core™ i7/i5 /i3& Pentium® processor (Tj 100°C), up to 35W
- **System Memory**
 - 1 x DDR4 2666/2400MHz SO-DIMM slot
 - Maximum memory up to 32GB
- **BIOS**
 - AMI UEFI BIOS

I/O System

- **Standard I/O**
 - 1 x COM (1 x RS-232/422/485)
 - 2 x USB 2.0
 - 2 x USB 3.0
 - 1 x Switch for power on/off
 - 1 x Remote switch for power on
 - 1 x AT/ATX switch
 - 1 x Grounding hole
 - 1 x HDMI output
 - 1 x DP output
 - 1 x VGA output by 9-pin D-sub female
 - 1 x Audio line out
- **Ethernet**
 - 1 x 10/100/1000 Mbps Ethernet with Intel® i211-AT; supports Wake-on-LAN, PXE Boot ROM
 - 1 x 10/100/1000 Mbps Ethernet with Intel® i219-V (LM); supports Wake-on-LAN, PXE Boot ROM

- **Expansion**
 - 1 x Full-size PCI-Express Mini Card slot (PCIe + SATA + USB)
 - 1 x M.2 Key E 2230 (for Wi-Fi)
- **Power connector**
 - 1x Phoenix power connector for DC power input

System Specifications

- 18.5" WXGA (1920x1080) LCD 500 nits with LED backlight
- Projected capacitive multi-touch
- Fanless design for heat dispensation
- IP65 aluminum front bezel
- **Storage**
 - 1 x 2.5" wide temperature SATA HDD/SSD (supports 7mm and 9.5mm; removable)
 - 1 x mSATA
- **Weight(Net/Gross)**
 - 7.8 kg (17.2 lb)/ 10.2kg (22.5 lb)
- **Dimensions**
 - System: 460 mm (18.11") (W) x 76 mm (3") (D) x 285 mm (11.22") (H)
 - Packing: 605 mm (23.81") (W) x 200 mm (7.87") (D) x 505 mm (19.88") (H)
- **Operating temperatures**
 - 0°C to 50°C (+32°F to +122°F)
- **Relative humidity**
 - 20% to 90% @ 40°C, Non-condensing
- **System power input**
 - DC power input: +12V/+19V/+24VDC with small Phoenix power connector



- *All specifications and images are subject to change without notice.*
- *The performance of the system might be adversely affected at an operating temperature above 40°C.*

1.3 Dimensions and Outlines

The figures below show the dimensions and outlines of the GOT318W-521-PCT panel PC.

Front dimensions: 460 mm (18.11") (W) x 77 mm (3.04") (D) x 285 mm (11.22") (H)

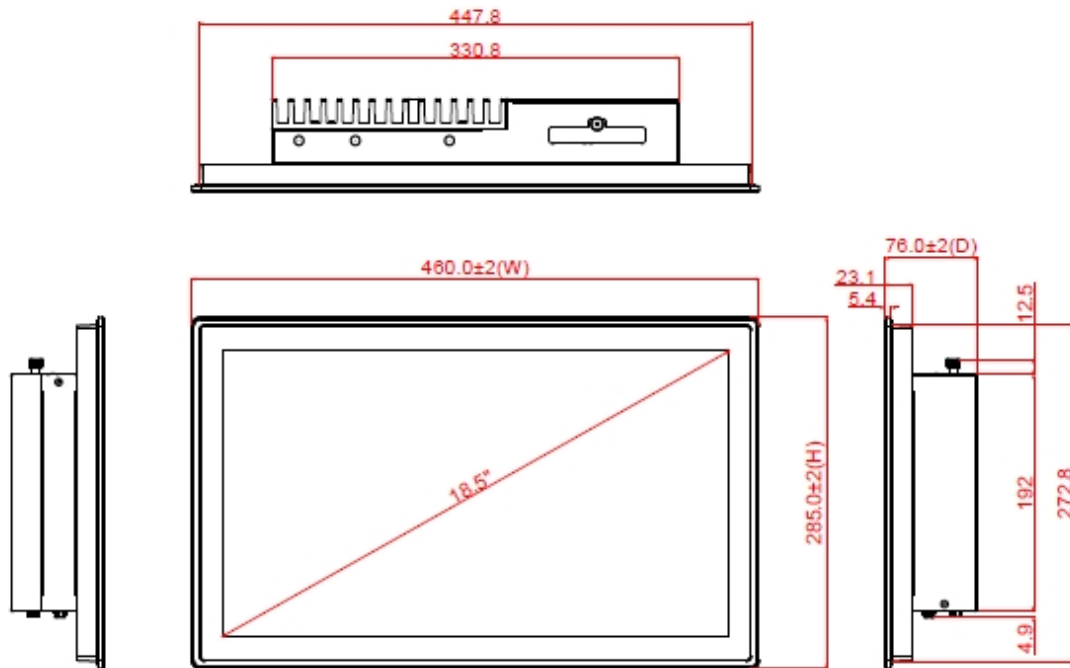

Figure 1-2: Outlines of the GOT318W-521-PCT

Figure 1-3: Back outline of the GOT318W-521-PCT

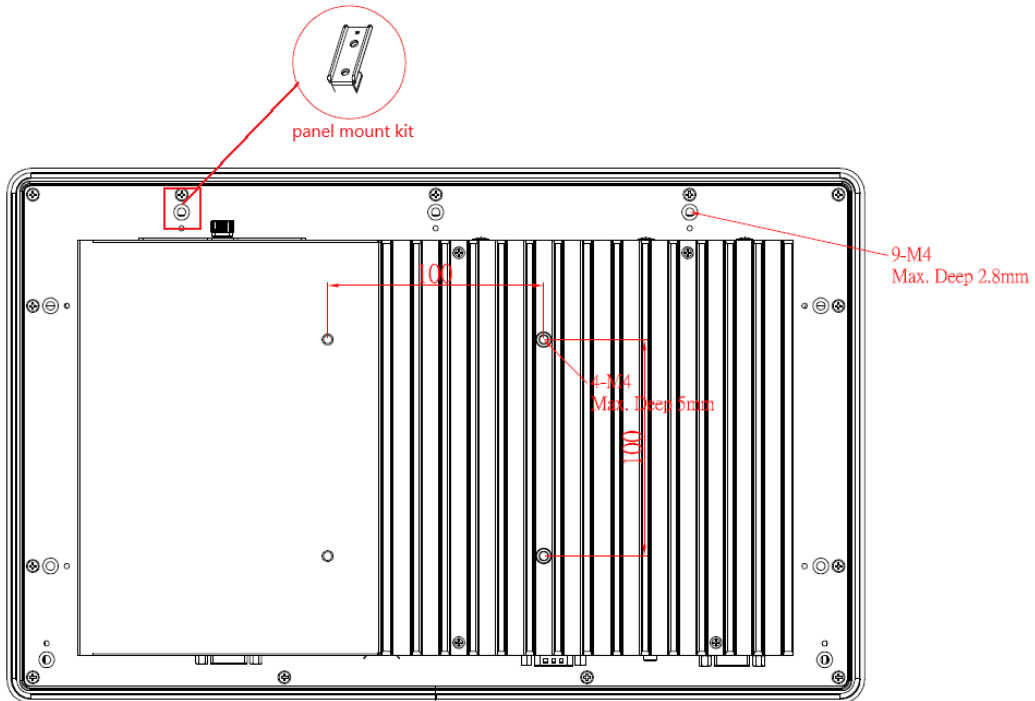
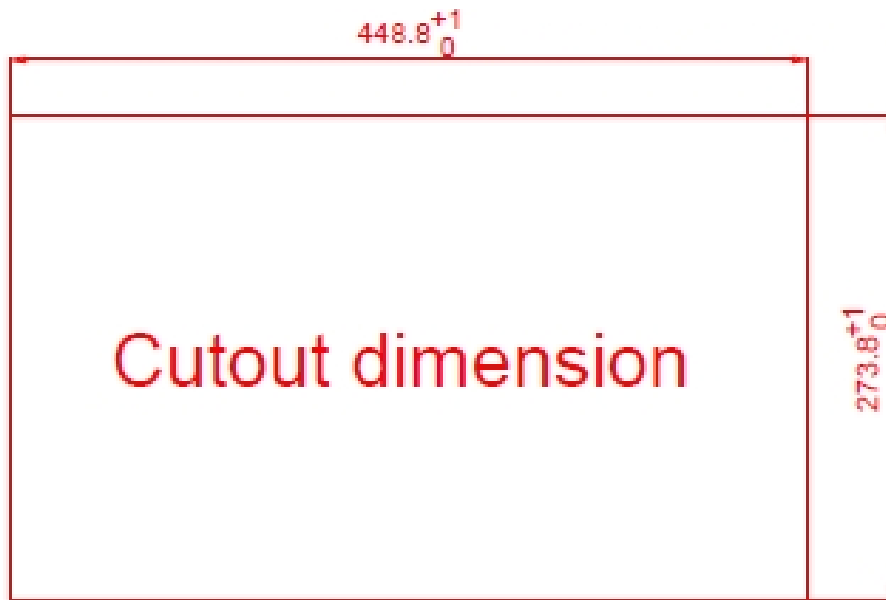

Figure 1-4: Cut-out dimensions of the GOT318W-521-PCT



Cut-out dimensions: 448.8 x 273.8 mm



NOTE

The wall depth limit for panel mount is 9 mm.

1.4 I/O Outlets

Please refer to figure 1-4 for the I/O locations of the GOT318W-521-PCT.

Figure 1-4: Bottom view of the GOT318W-521-PCT

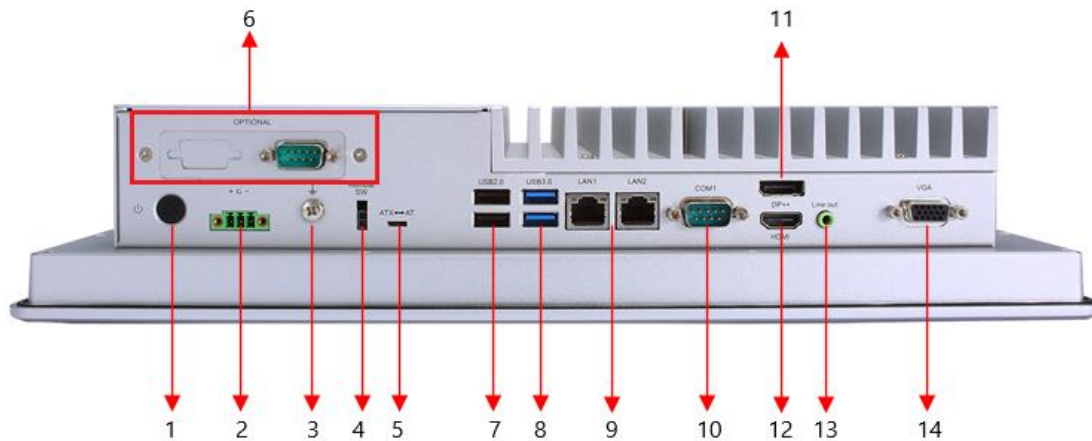

No.	Note.	No.	Note.
1	Power button	8	2x USB3.0
2	Phoenix type power connector	9	2x RJ-45 for Giga Ethernet
3	Grounding hole	10	1x COM for RS232/422/485
4	Remote power switch	11	1x DP out
5	AT/ATX quick switch	12	1x HDMI out
6	Optional flexible I/O (Default 1x RS-232)	13	1x Line out
7	2x USB2.0	14	1x VGA



The GOT318W-521-PCT only supports one output type (DP, HDMI, or VGA) for the second display.

1.5 Packing List

A complete bundled package should contain the following items:

- GOT318W-521-PCT unit x 1
- Phoenix connector (DC power version only)

Please contact an Axiomtek distributor immediately if any of the above-mentioned items is missing.

This page is intentionally left blank.

SECTION 2

HARDWARE INSTALLATION

The GOT318W-521-PCT provides rich I/O ports and flexible expansion features for users to perform various tasks. This section provides detailed information on the hardware components of the panel PC as well as installation instructions, including the following subsections:

- Open Back Cover
- Jumper and Connector Settings
- Mounting Methods
- Hardware Installation
- Power Input

2.1 Open Back Cover

Please follow the steps below to open the GOT318W-521-PCT unit.

Step 1 Remove the four screws (see red circles in Figure 2-1) on the back cover.

Figure 2-1: Back cover

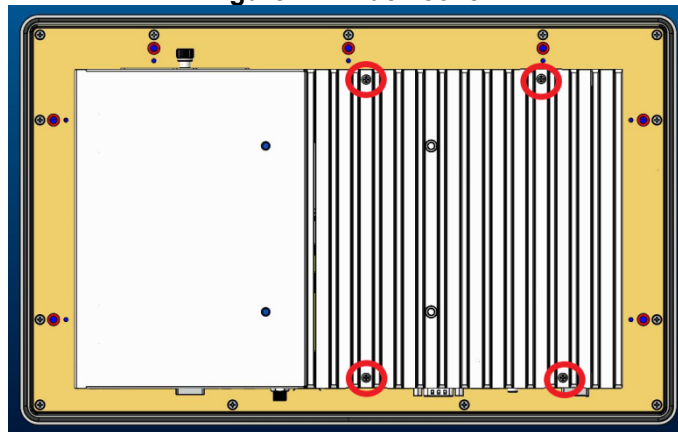

Step 2 Remove the back cover.

Figure 2-2: Board layout

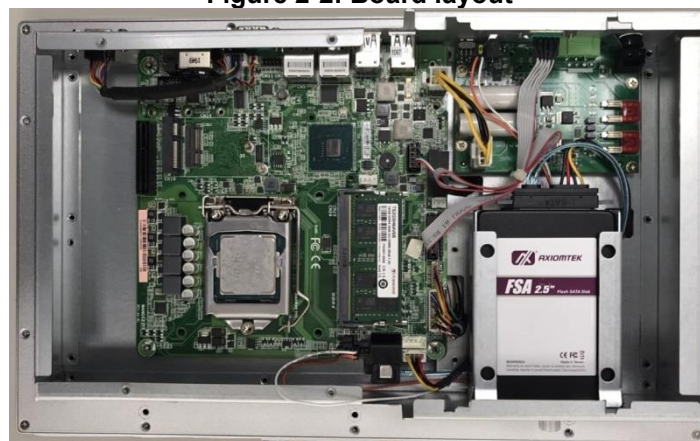

2.2 Jumper and Connector Settings

A jumper is a small component consisting of a jumper clip and jumper pins. Proper configuration of jumper settings enables the GOT318W-521-PCT to meet various application purposes.

The illustration below shows how to set up jumpers: Place the jumper clip on two jumper pins to close the jumper pins; remove the jumper clip from two jumper pins to open the jumper pins.

Figure 2-3: Definitions of pin settings

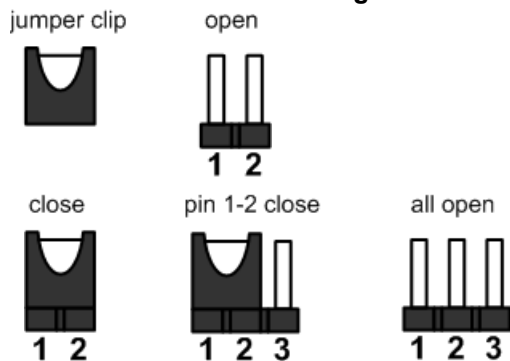

Before applying power to GOT318W-521-PCT, please make sure all of the jumpers and connectors are in default positions, as listed in Table 2-1.



NOTE

Make sure the system is powered off prior to changing any default jumper settings.

Table 2-1: Factory mode of jumper settings

Jumper	Descriptions	Setting
JP4	Restore BIOS optional defaults (Clear CMOS) Default: normal operation	1-2 closed
JP6	AT/ATX power mode select Default: ATX mode	1-2 closed

2.2.1 Restore BIOS Optimal Defaults Jumper (JP4)

This jumper allows you to clear the Real Time Clock (RTC) RAM in CMOS. You can clear the CMOS memory of date, time, and system setup parameters by erasing the CMOS RTC RAM data. The onboard button cell battery powers the RAM data in CMOS, which includes system setup information such as system passwords.

To erase the RTC RAM:

1. Turn OFF the computer and unplug the power cord.
2. Remove the onboard battery.
3. Move the jumper clip from pins 1-2 (default) to pins 2-3. Keep the clip on pins 2-3 for about 5~10 seconds, then move the clip back to pins 1-2.
4. Re-install the battery.
5. Plug the power cord and turn ON the computer.
6. Hold down the key during the boot process and enter BIOS setup to re-enter data.

Function	Setting
Normal operation (default)	1-2 closed
Restore BIOS optimal defaults	2-3 closed



2.2.2 Auto Power On Jumper (JP6)

If JP6 is enabled for power input, the system will be automatically power on without the need to press the soft power button. If JP7 is disabled for power input, it is necessary to manually press the soft power button to power on the system

Function	Setting
Enable auto power on "ATX mode" (default)	1-2 closed
Disable auto power on "AT mode"	2-3 closed



NOTE

Either one setting (AT/ATX switch or JP7) set to AT mode will be operated by AT power.

2.2.3 COM Port Connector

This connector is a standard D-Sub connector for the COM1 serial port interface, which can be set to use RS-232/422/485 mode via the BIOS setting (see section 4.4). The pin assignments of RS-232/422/485 are listed in the table below.

Table 2-4 Pin assignment for RS-232/ 422/ 485

Pin	RS-232	RS-422	RS-485
1	DCD	TX-	Data-
2	RXD	TX+	Data+
3	TXD	RX+	N/C
4	DTR	RX-	N/C
5	GND	GND	GND
6	DSR	N/C	N/C
7	RTS	N/C	N/C
8	CTS	N/C	N/C
9	RI	N/C	N/C

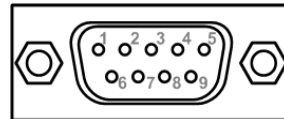

2.3 Ethernet Connector

The GOT318W-521-PCT has two RJ-45 connectors: LAN1 and LAN2. Ethernet connection can be established by plugging one end of the Ethernet cable into this RJ-45 connector and the other end (phone jack) into a 1000/100/10-Base-T hub.

Please refer to Table 2-5 for detailed pin assignment for LAN1 and LAN2.

Table 2-5 Pin assignment for LAN1/ LAN2

Pin	1000 Base-T	100/10 Base-T	Description
L1	BI_DA+	TX+	Bidirectional or Transmit Data+
L2	BI_DA-	TX-	Bidirectional or Transmit Data-
L3	BI_DB+	RX+	Bidirectional or Receive Data+
L4	BI_DC+	N.C.	Bidirectional or Not Connected
L5	BI_DC-	N.C.	Bidirectional or Not Connected
L6	BI_DB-	RX-	Bidirectional or Receive Data-
L7	BI_DD+	N.C.	Bidirectional or Not Connected
L8	BI_DD-	N.C.	Bidirectional or Not Connected
A	Active Link LED (Yellow) Off: No link Blinking: Data activity detected		
B	Speed LED 1000: Orange 100/10: Green/OFF		

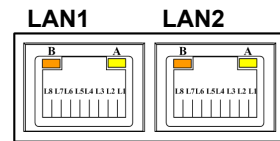

LAN1 with Intel® i211AT

LAN2 with Intel® i219V

2.4 Mounting the Panel PC



Only trained and qualified technicians are permitted to mount the product. To prevent accidental damage to the product or human injury when mounting the product, at least two people are required to perform the installation.

The GOT318W-521-PCT panel PC option supports four types of mounting methods.

- Panel mount
- Wall mount
- VESA arm mount
- Desktop mount

2.4.1 Panel Mount

Panel mount kit is optional, a set of panel mount kits, including screws and particular hook brackets for panel mounting. Use the panel mount kits to mount the GOT318W-521-PCT into a panel.

- Step 1** Prepare a panel frame to accommodate the panel PC. Ensure that the cutout of the frame perfectly fits the monitor's dimensions.
- Step 2** Put the panel PC into the cutout on the front side of the frame, with the panel PC's front bezel facing the outside, as shown in Figure 2-4.

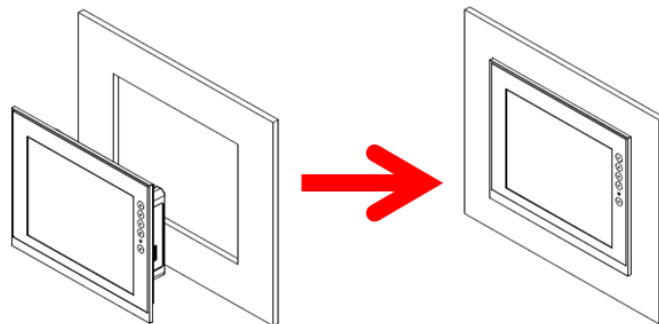

Figure 2-4: Fitting the panel PC into a frame.

Step 3 Locate the screwing holes and the positions of the hook brackets on the back side of the panel PC, as shown in the Figure 2-5.

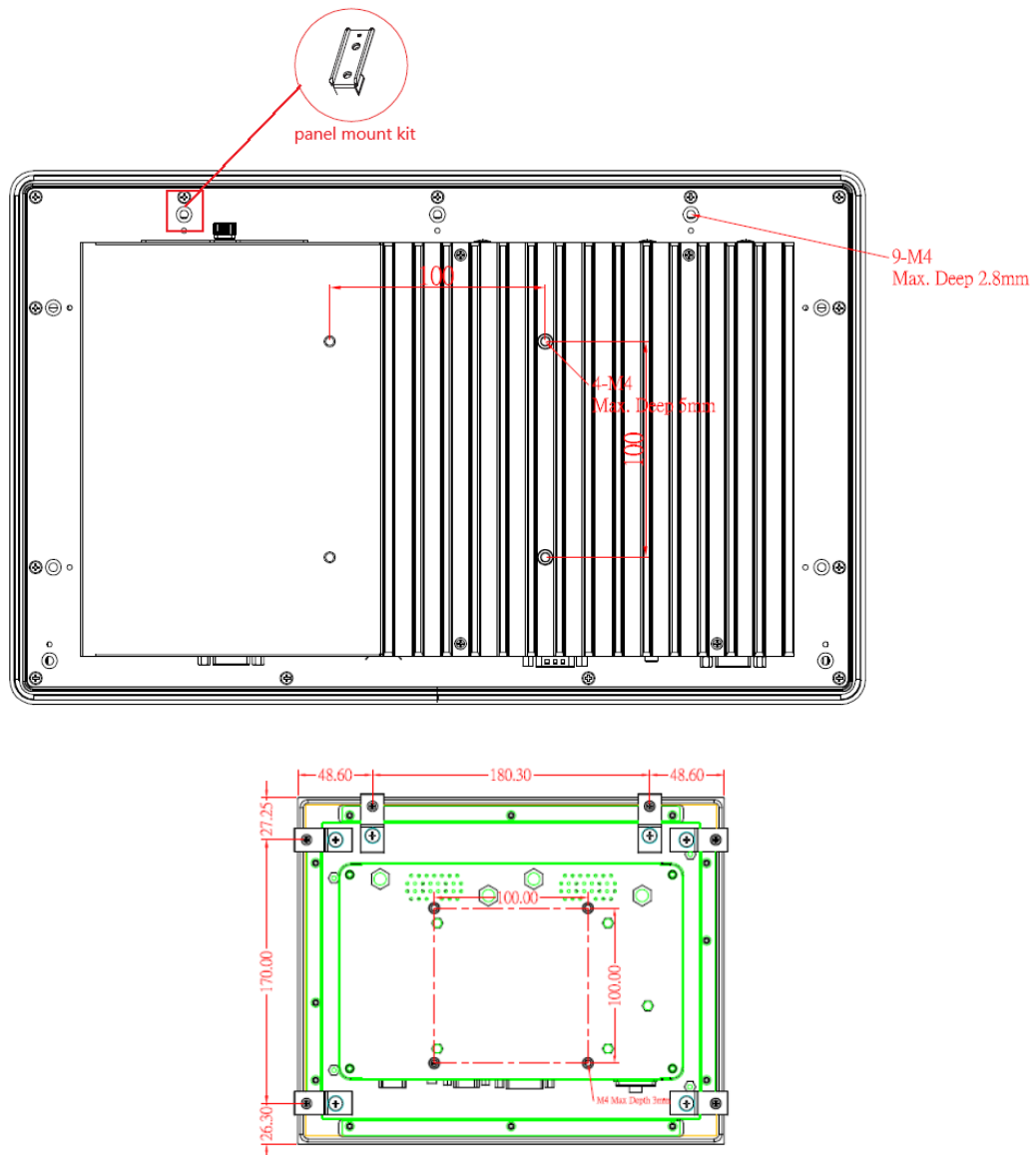

Figure 2-5: Panel mount dimensions (back chassis)

- Step 4** As Figure 2-6 below illustrates, use the panel mount kits to secure the panel PC in the panel frame. Insert the screws through the hook brackets into the corresponding holes on the back chassis of the panel PC. Tighten the screws to fix the panel PC firmly into the panel frame.

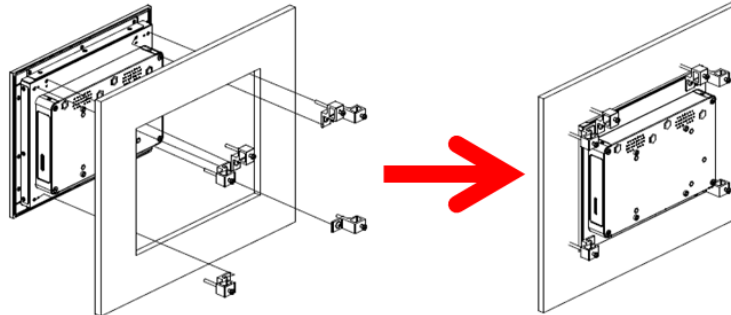

Figure 2-6: Screwing the Panel PC firmly to the panel frame.

2.4.2 Wall Mount

The GOT318W-521-PCT can be mounted onto a wall using the wall mount bracket.

- Step 1** On the back chassis of the panel PC, locate the screwing holes for assembling the wall mount bracket, as shown in Figure 2-7.

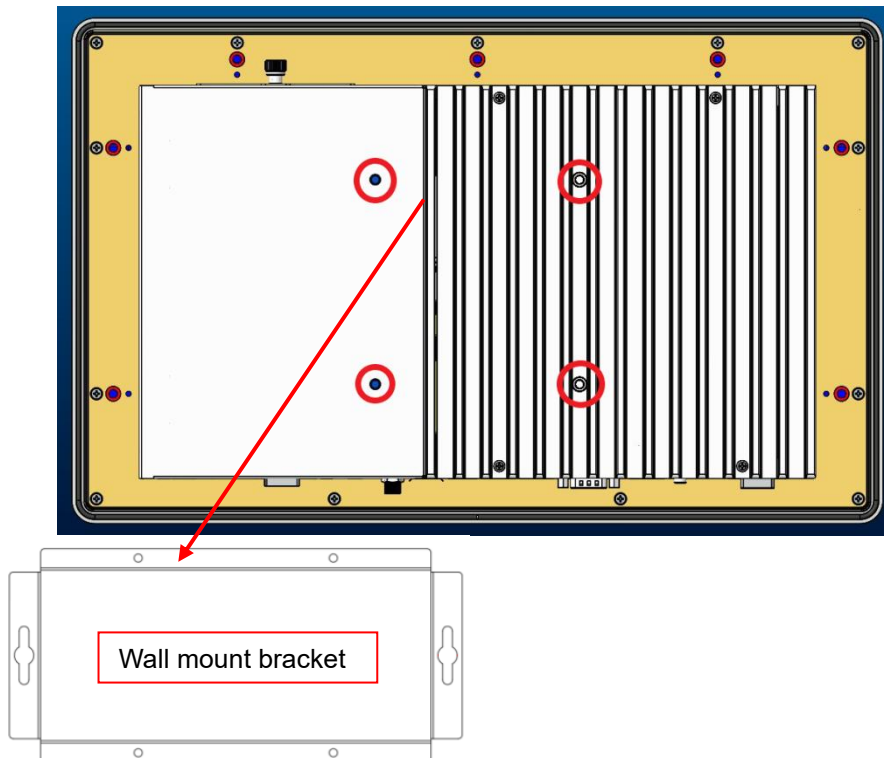

Figure 2-7: Wall mount screwing holes on the back chassis

- Step 2** Attach the wall mount bracket to the back of the panel PC by aligning the screwing openings on the top and bottom edges of the bracket with the screwing holes on the back chassis. Then screw the bracket firmly to the back of the panel PC, as illustrated in Figure 2-8.

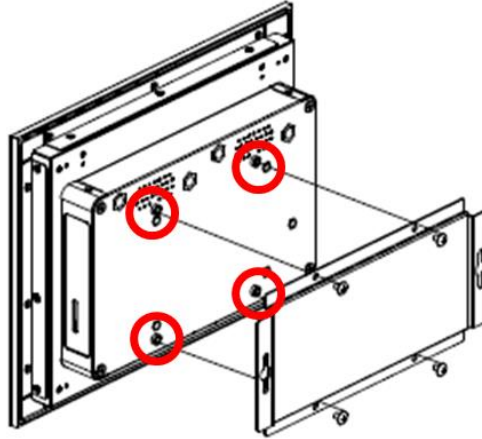

Figure 2-8: Attaching the wall mount bracket

- Step 3** Select an appropriate location on the wall to mount the panel PC, as illustrated below.

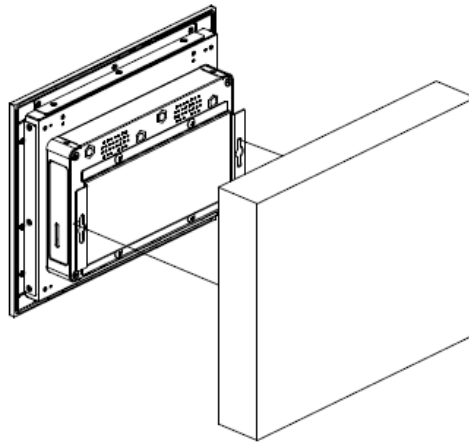

Figure 2-9: Mounting the panel PC on the wall

2.4.3 VESA Arm Mount

Alternatively, the GOT318W-521-PCT supports VESA arm mount by using a VESA arm kit attached to the back, allowing users to tilt or rotate the panel PC for best visibility. Refer to the following steps when adopting VESA arm mount for the panel PC.

Step 1 Locate the four screwing holes on the back side of the panel PC.

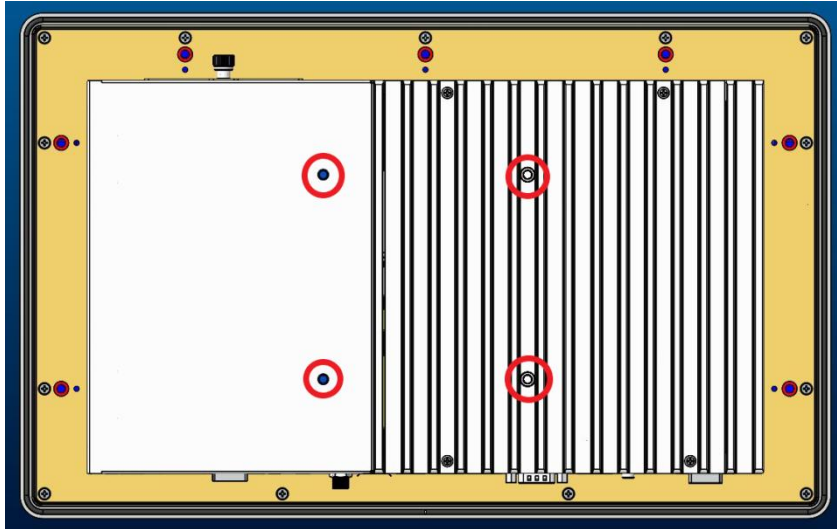

Figure 2-10: VESA mount screwing holes on the back chassis

Step 2 As illustrated below, assemble the VESA arm kit to the back chassis of the panel PC. Tighten the four screws to fasten the VESA arm kit firmly to the back chassis.



Figure 2-11: Assembling the VESA arm kit to the panel PC

2.2.4 Desktop Mount

Desktop mount is used to mount the GOT318W-521-PCT on the desk using a desktop stand. After assembling the desktop mount kit to the back of the panel PC, users can mount the unit on the desk.

- Step 1** Locate the screwing openings on the desktop mount bracket, as marked in the figure below.
- Step 2** As illustrated, assemble the stand to the desktop mount bracket on the back of the panel PC. Tighten the screws firmly into the screwing spots to secure the stand in place.

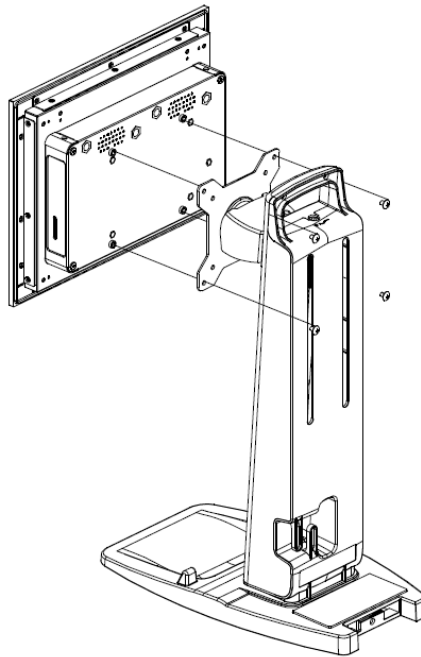

Figure 2-12: Assembling the desktop stand to the panel PC

2.5 Hardware Installation

2.5.1 Installing an HDD

The GOT318W-521-PCT provides a convenient swappable Hard Disk Driver (HDD) bracket for users to install a 2.5" (supports 7mm & 9.5mm) wide temperature SATA HDD. Please follow the steps below to install the HDD:

Step 1 Refer to Section 2.1 to open the back cover

Step 2 Unfasten the bracket screw and then slide the HDD bracket out of the system unit. (as shown in Figure 2-13)

Figure 2-13: Remove the HDD tray

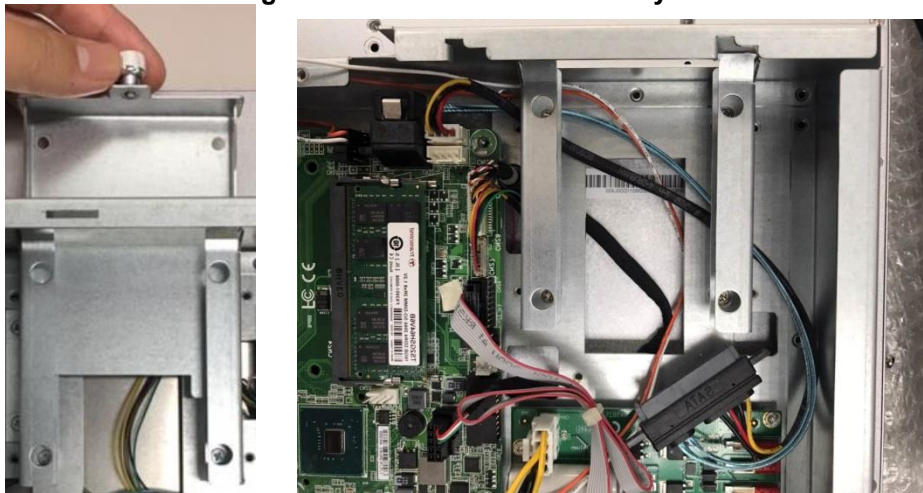

Step 3 Insert the 2.5" HDD into the bracket and fasten the four screws on the bottom side of the bracket to hold the HDD firmly to the bracket.

Step 4 Slide the bracket back into the system unit.

Step 5 Plug the "SATA + Power" connector into the HDD.

Step 6 Fasten the bracket screw to complete installation.



Figure 2-14: Fasten an HDD to the bracket and plug in the "SATA + Power" connector

2.5.2 Installing DRAM

The GOT318W-521-PCT provides one 260-pin DDR4 2666/2440Mhz SO-DIMM socket that supports system memory up to 32GB. Please follow the steps below to install a memory module:

- Step 1** Refer to Section 2.1 to open the back cover.
- Step 2** Locate the DIMM socket on the mainboard, as shown in Figure 2-16 ,then remove the release paper from the Thermal Pad (Part number 662000002100 as shown Figure 2-15) put it on the red square as shown in Figure 2-17
- Step 3** To ensure correct installation, align the memory module with the socket so that the notches of the memory module can match the socket keys.
- Step 4** Insert the module's gold contacts into the DIMM socket and then push the module down until it is clipped in place by the socket as shown in Figure 2-18
- Step 5** Remove the release paper from the Thermal Pad (Part number 662000002000 as shown Figure 2-15) then put it on the blue square of back cover as shown in Figure 2-19
- Step 6** Fasten the bracket screw to complete installation.

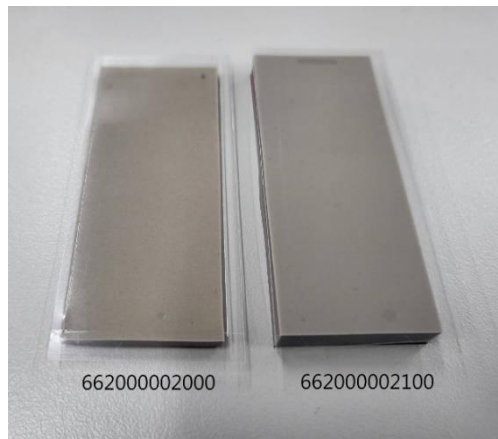

Figure 2-15: Thermal pad for RAM installation

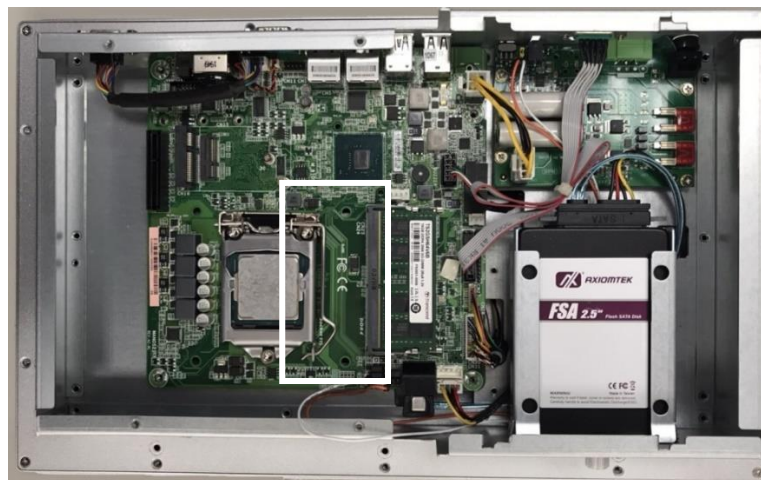

Figure 2-16: DIMM socket position

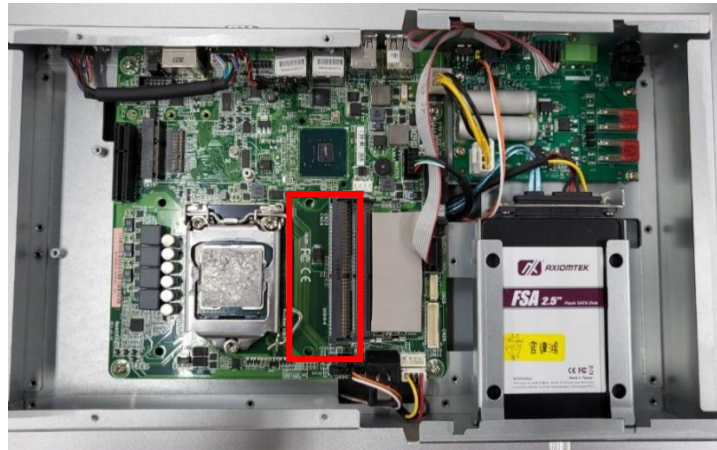

Figure 2-17: Thermal pad position of mainboard



Figure 2-18: Installing a memory module

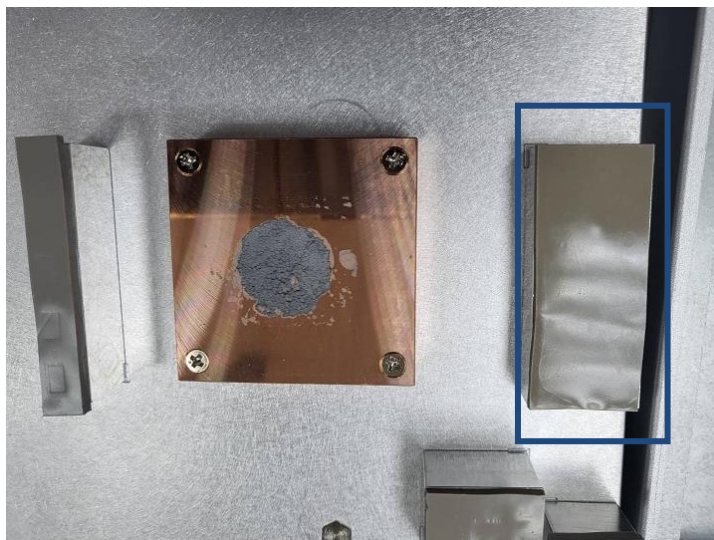

Figure 2-19: Thermal pad position of back cover

2.5.3 Installing a CPU

The main board's CPU socket type supports the 8th/9th Gen Intel® Core™ processors up to 35W:

Step 1 Opening the socket

- Disengage the load lever by pressing the lever down and pulling it slightly away by the hook. This will release the load lever from the retention tab.
- Rotate the load lever upward to the fully-open position, at approximately 150°. This action will disengage the load plate away from the socket and lift it to the open position at approximately 135°.

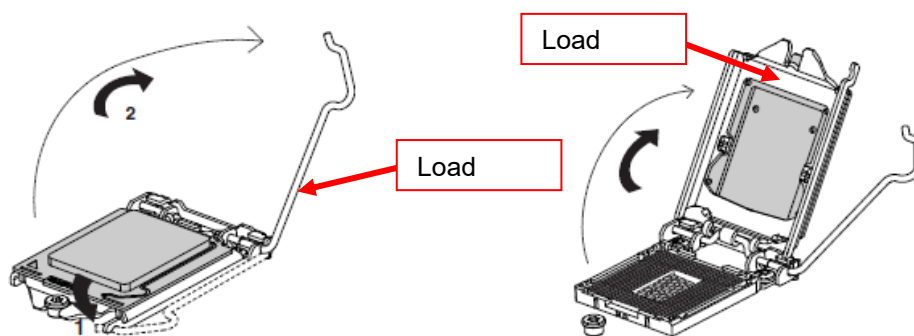

Figure 2-20



NOTE

Apply pressure to the corner when opening or closing the load lever - otherwise the lever will bounce back (similar to how a mouse trap works) causing bent contacts.

Step 2 Installing the Processor

- Lift the processor package from shipping media by grasping the substrate edges.



Figure 2-21

- Scan the processor package's gold pads for any presence of foreign material. If necessary, the gold pads can be wiped clean with a soft lint-free cloth and isopropyl alcohol.

- Prior to installing the processor, pay attention to the processor package's orientation by aligning the connection 1 indicator chamfers on the processor and the socket. Also make sure that the processor keying features (positioning notches) on both sides of the processor line up with the posts along the socket walls.

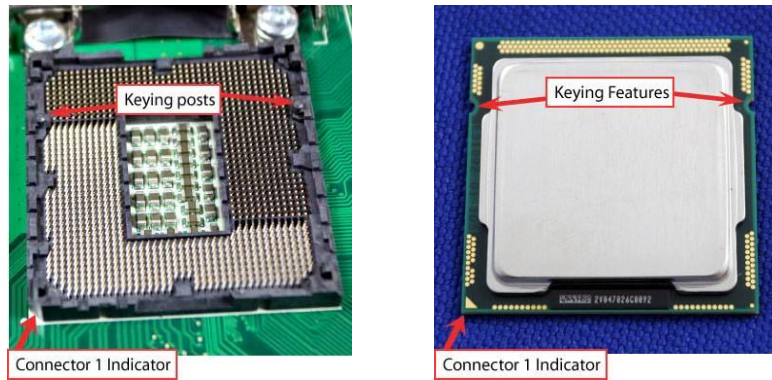

Figure 2-22

- Grasp the processor with the thumb and index finger along the top and bottom edges.
- The socket will have cutouts for your fingers to fit into.
- While aiming the positioning notches on the processor with the posts on the socket walls, carefully place the processor into the socket body vertically.

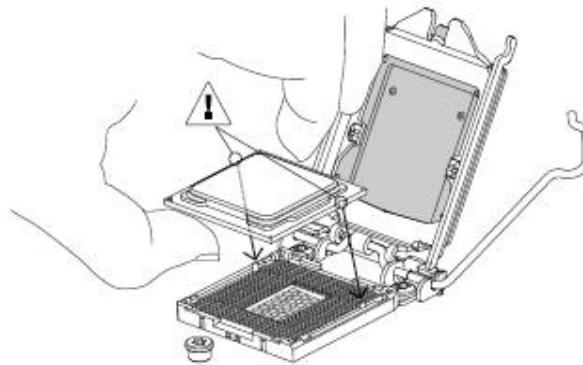

Figure 2-23



To avoid damage, never touch the fragile contact pins of the socket and the processor at any time during installation.

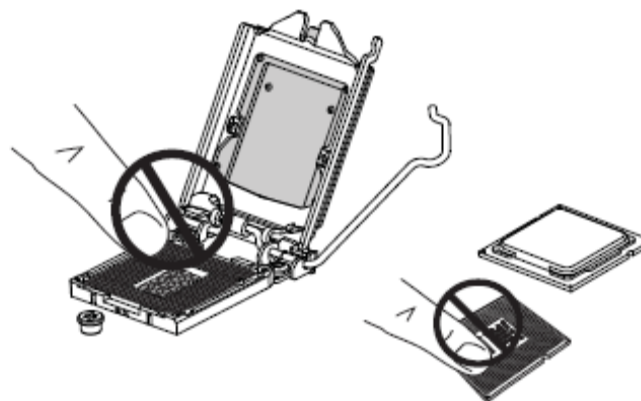

Figure 2-24

Step 3 Close the socket

- Remove the CPU protective cover from the load plate.
- Gently lower the load plate. Make sure the load plate's front edge slides under the shoulder screw cap as the lever is lowered.
- Latch the lever under the top plate's corner tab. Be cautious not to damage the motherboard with the tip of the lever.

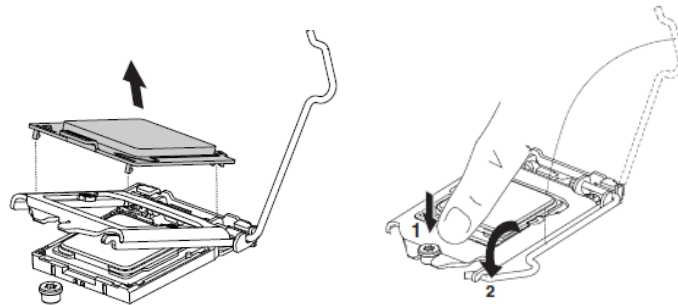

Figure 2-25



NOTE

Should the system unit need shipping for an RMA request, make sure to put the CPU protective cover back onto the CPU socket to protect the socket pins.

2.5.4 Connecting the Power Input

The GOT318W-521-PCT is equipped with a Phoenix type power connector which supports 12V/19V/24V DC. Please follow the signs on the power connector to connect to DC power source (see Figure 2-26).

Figure 2-26: Power connector

+: Power positive

—: Power negative

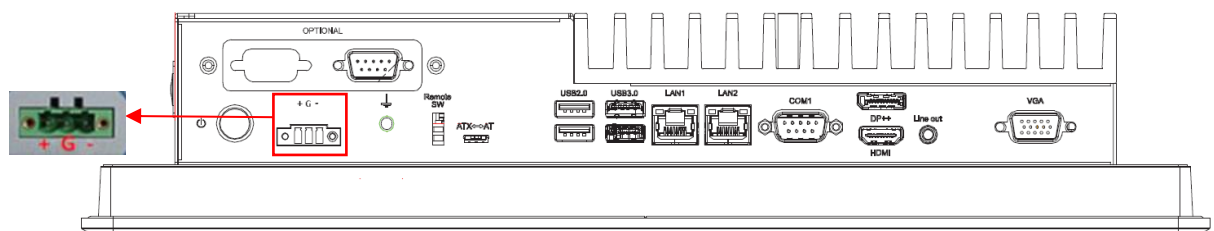

NOTE

The safety ground must be connected to ensure that the unit works appropriately.

SECTION 3

AMI BIOS SETUP UTILITY

This section provides users with detailed descriptions about how to set up basic system configurations through the AMI BIOS setup utility.

3.1 Starting

To enter the setup screens, follow the steps below:

1. Turn on the computer and press the key immediately.
2. After pressing the key, the main BIOS setup menu displays. Users can access to other setup screens, such as the Advanced and Chipset menus, from the main BIOS setup menu.

3.2 Navigation Keys

The BIOS setup/utility uses a key-based navigation system called hot keys. Most of the BIOS setup utility hot keys can be used at any time during the setup navigation process. These keys include <F1>, <F2>, <Enter>, <ESC>, <Arrow> keys, and so on.



NOTE

Some of the navigation keys differ from one screen to another.

Table 3-1 Descriptions of hot keys

Hot Keys	Description
→← Left/Right	The Left and Right <Arrow> keys allow you to select a setup screen.
↑↓ Up/Down	The Up and Down <Arrow> keys allow you to select a setup screen or sub screen.
Enter	The <Enter> key allows you to display or change the setup option listed for a particular setup item. The <Enter> key can also allow you to display the setup sub screens.
+– Plus/Minus	The Plus and Minus <Arrow> keys allow you to change the field value of a particular setup item.
F1	The <F1> key allows you to display the General Help screen.
F2	The <F2> key allows you to Load Previous Values.
F3	The <F3> key allows you to Load Optimized Defaults.
F4	The <F4> key allows you to save any changes you have made and exit Setup. Press the <F4> key to save your changes.
Esc	The <Esc> key allows you to discard any changes you have made and exit the Setup. Press the <Esc> key to exit the setup without saving your changes.

3.3 Main Menu

When you first enter the setup utility, you will enter the Main setup screen. You can always return to the Main setup screen by selecting the Main tab. System Time/Date can be set up as described below. The Main BIOS setup screen is shown below

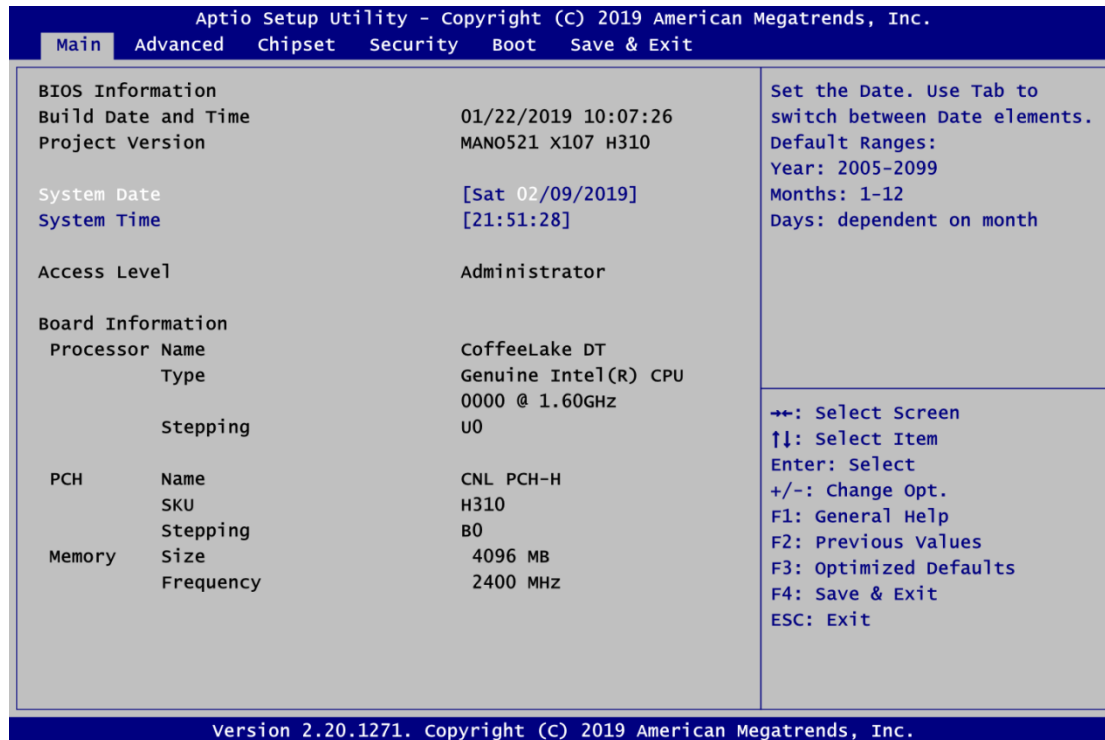

BIOS Information

Display the BIOS information.

System Date/Time

Use this option to change the system time and date. Highlight System Time or System Date using the <Arrow> keys. Enter new values through the keyboard. Press the <Tab> key or the <Arrow> keys to move between fields. The date must be entered in MM/DD/YY format. The time is entered in HH:MM:SS format.

Access Level

Display the access level of the current user.

Board Information

Display the board information.

3.4 Advanced Menu

The Advanced menu allows users to configure the CPU and other system devices. You can select any of the items in the left frame of the screen to go to the sub menus

- ▶ IT8625 Super IO Configuration
- ▶ Hardware Monitor
- ▶ Trusted Computing
- ▶ ACPI Settings
- ▶ CPU Configuration
- ▶ SATA and RST Configuration
- ▶ PCH-FW Configuration
- ▶ USB Configuration

For items marked with “▶”, please press <Enter> for more options.

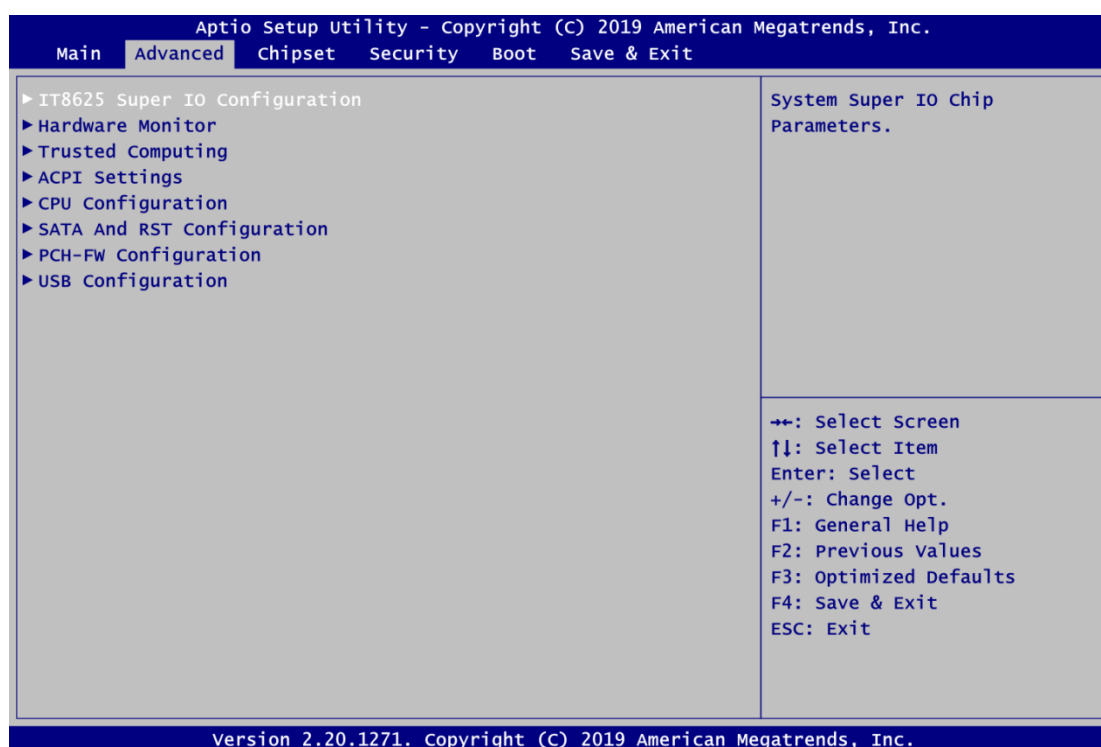

3.4.1 IT8625 Super IO Configuration

You can use this screen to select options for the Super IO Configuration, and change the value of the selected option. A description of the selected item appears on the right side of the screen. For items marked with "▶", please press <Enter> for more options.

Serial Port 1~2 Configuration

This option is used to enable or disable serial port 1~2

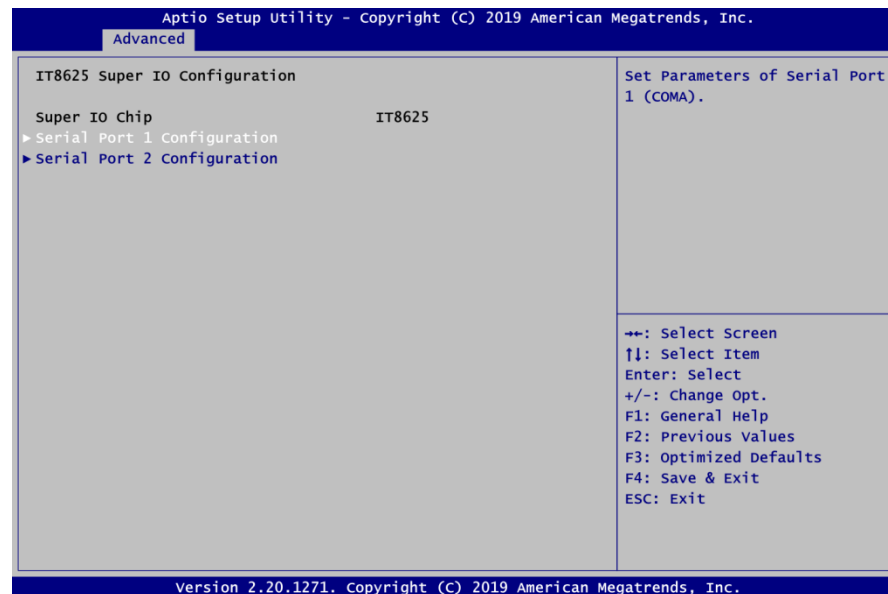

- **Serial Port 1 Configuration**

Serial Port

Enable or disable serial port 1. The optimal setting for base I/O address is 3F8h and for interrupt request address is IRQ4.

COM Port Type

Use this item to set RS-232/422/485 communication mode.

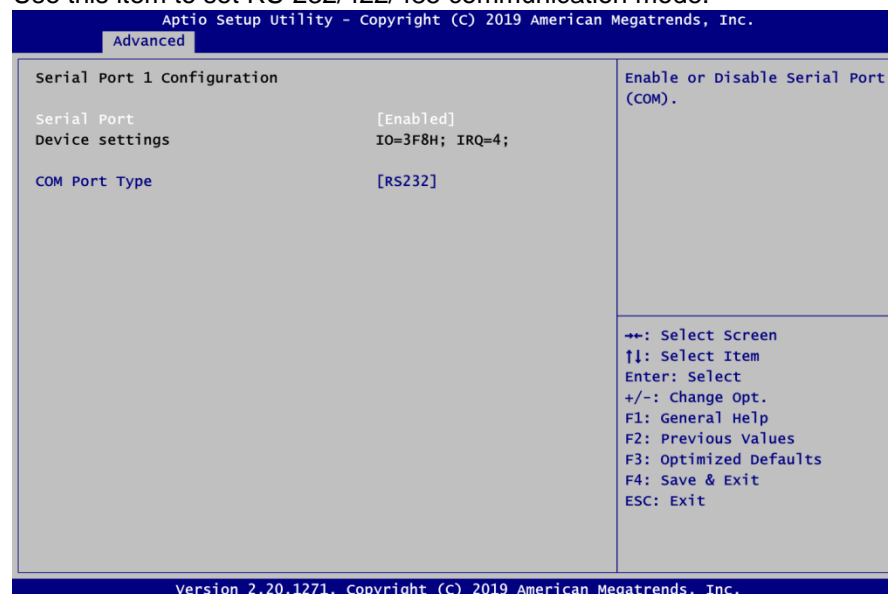

- **Serial Port 2 Configuration**

Serial Port

Enable or disable serial port 2. The optimal setting for base I/O address is 2F8h and for interrupt request address is IRQ3

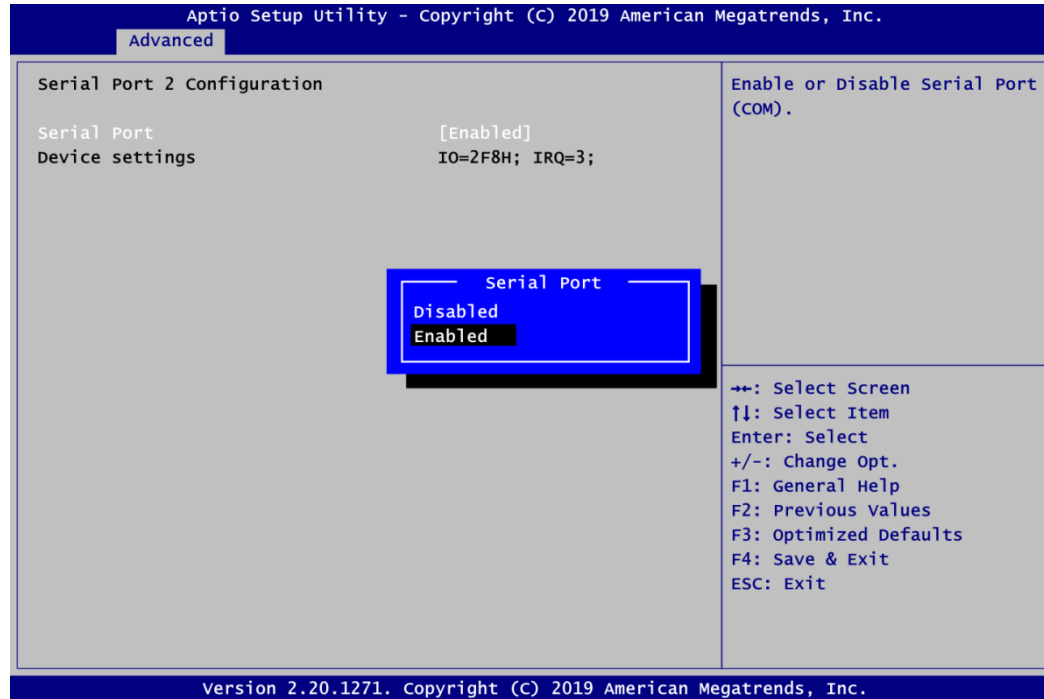

3.4.2 Hardware Monitor

This screen monitors and displays the hardware health status of the system in real time, including system and CPU temperatures, cooling fan speed in RPM and system voltages (VCC_CPU, +3.3V, +12V, +5V, +5V standby, +3.3V standby and VBAT).

Case Open

Switch on or off case open

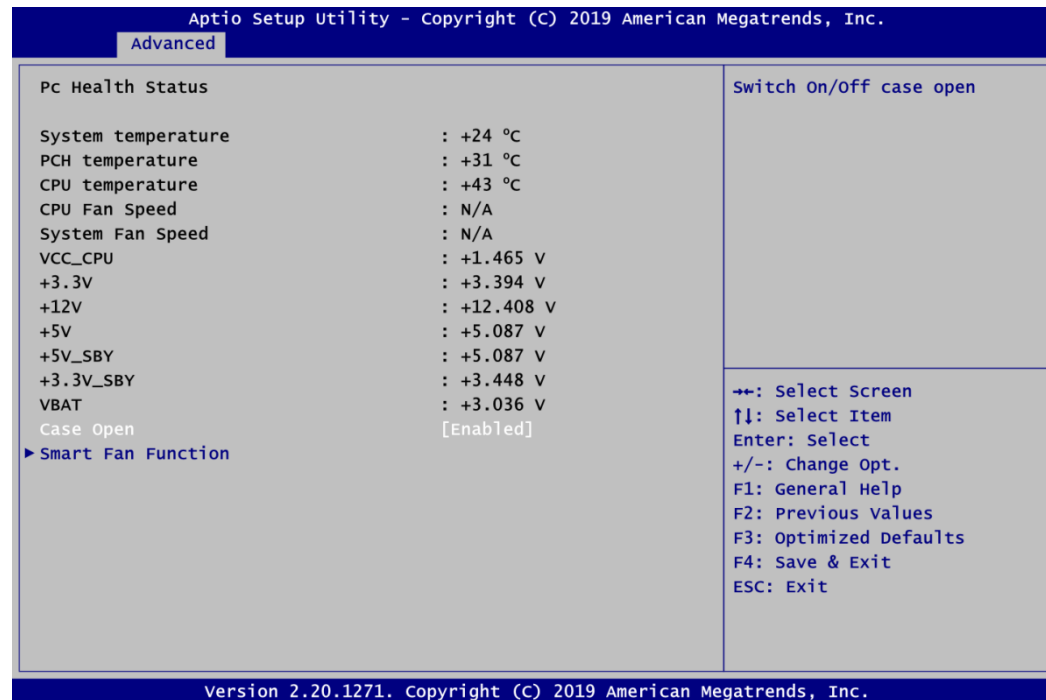

NOTE

The default case open setting for the Intel® Q370 SKU is disabled.

3.4.3 Trusted Computing

If the user install a security device, such as TPM, the system will show the following TPM device information and functions for specifying the TPM settings.

Security Device Support

Enable or disable BIOS support for the security device. OS will not show security device. TCG EFI protocol and INT1A interface will not be available.

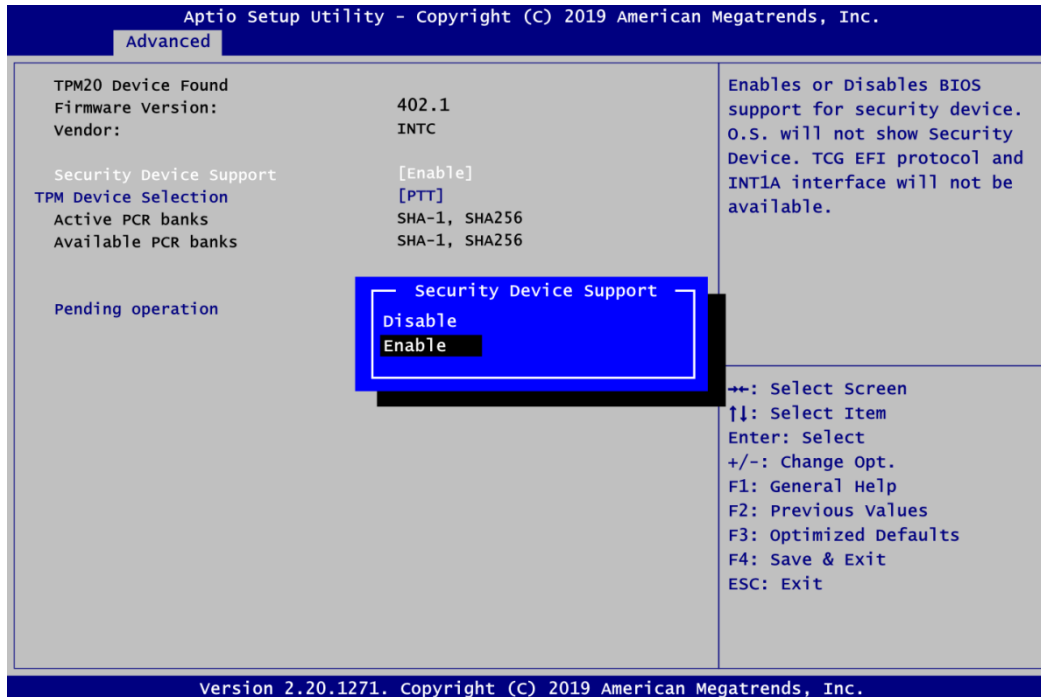

TPM Device Selection

Select a TPM device:

- dTPM: External extended Infineon's TPM

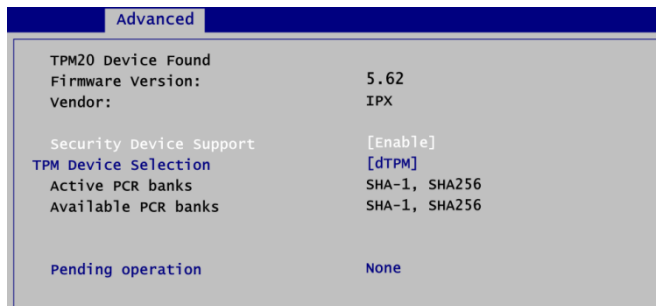

- PTT: Intel® built-in TPM.

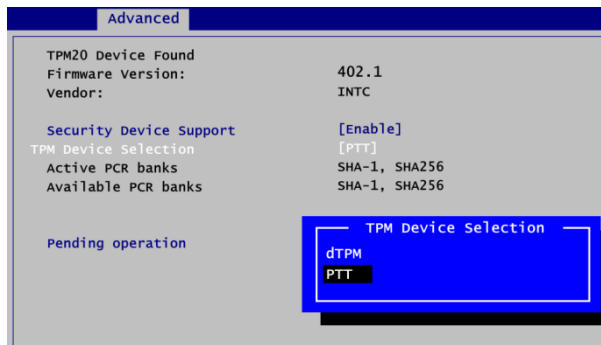

Pending operation

Schedule an operation for the security device, as shown in the image below.

- None
- TPM Clear: Clear all data secured by TPM.

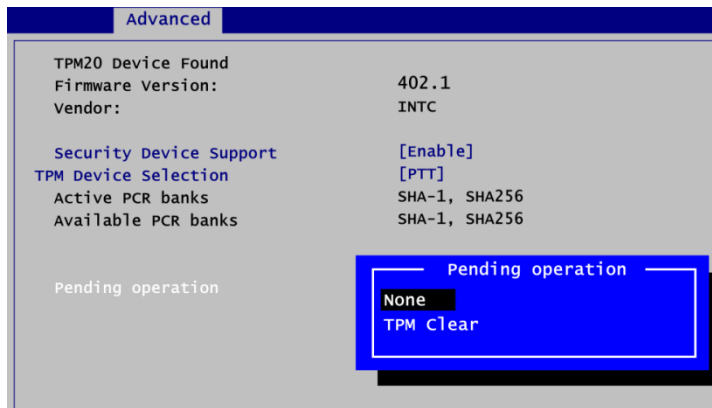

3.4.4 ACPI Setting

ACPI Sleep State

When the suspend button is pressed, the default ACPI (Advanced Configuration and Power Interface) sleep state is S3 (Suspend to RAM).

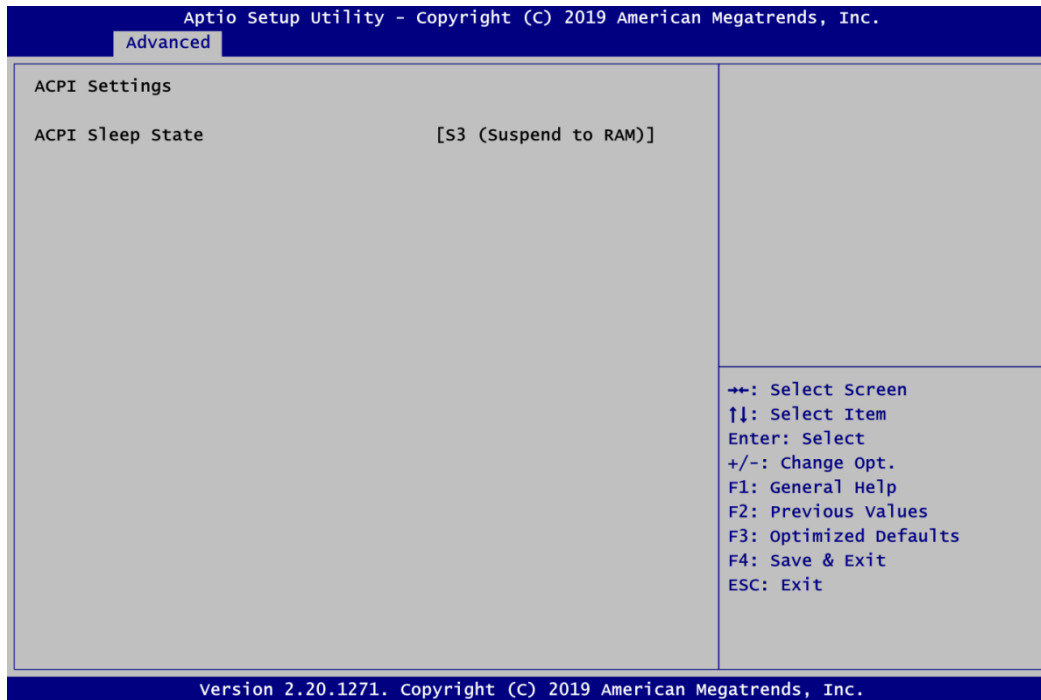

3.4.5 CPU Configuration

Intel (VMX) Virtualization Technology

Enable or disable Intel Virtualization Technology. When enabled, a VMM (Virtual Machine Mode) can utilize the additional hardware capabilities. It allows a platform to run multiple operating systems and applications independently, hence enabling a single computer system to work as several virtual systems.

Below shows a page of CPU configuration with item *Intel Virtualization Technology* [enable/disable] highlighted.

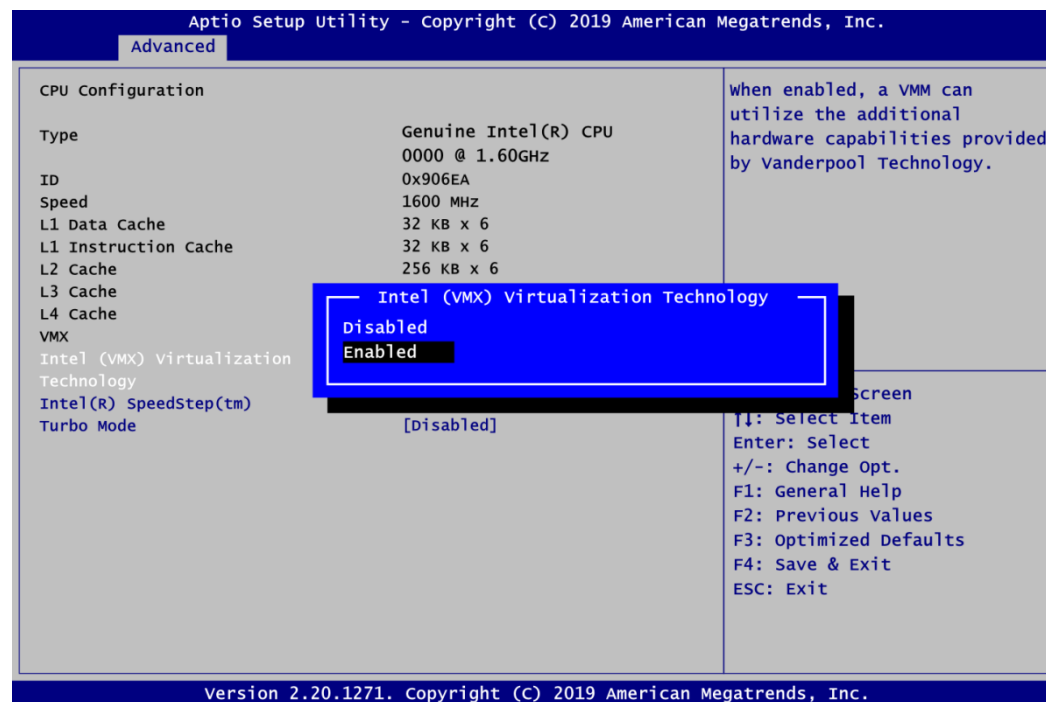

Intel(R) SpeedStep(tm)

Enable or disable Intel® SpeedStep, which allows the system to support more than two frequency ranges.

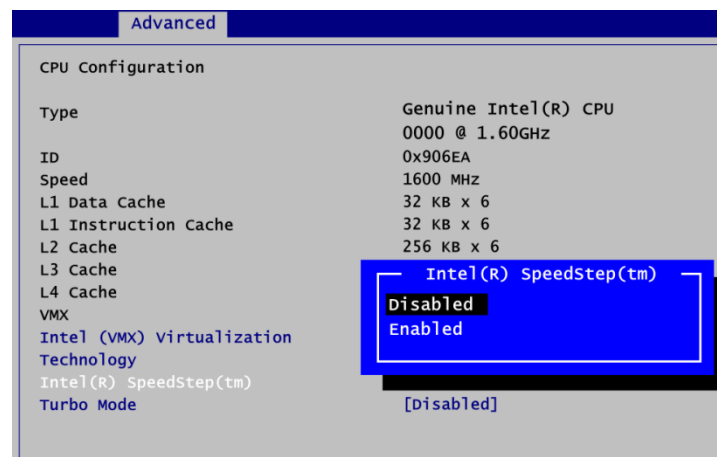

Power Limitation Setting

If the system power input is 12V DC, please enable the “**Limited at 20W when 12V-DC**”, the CPU TDP will be limited at 20W to avoid unexpected power off issues due to electric current overload.

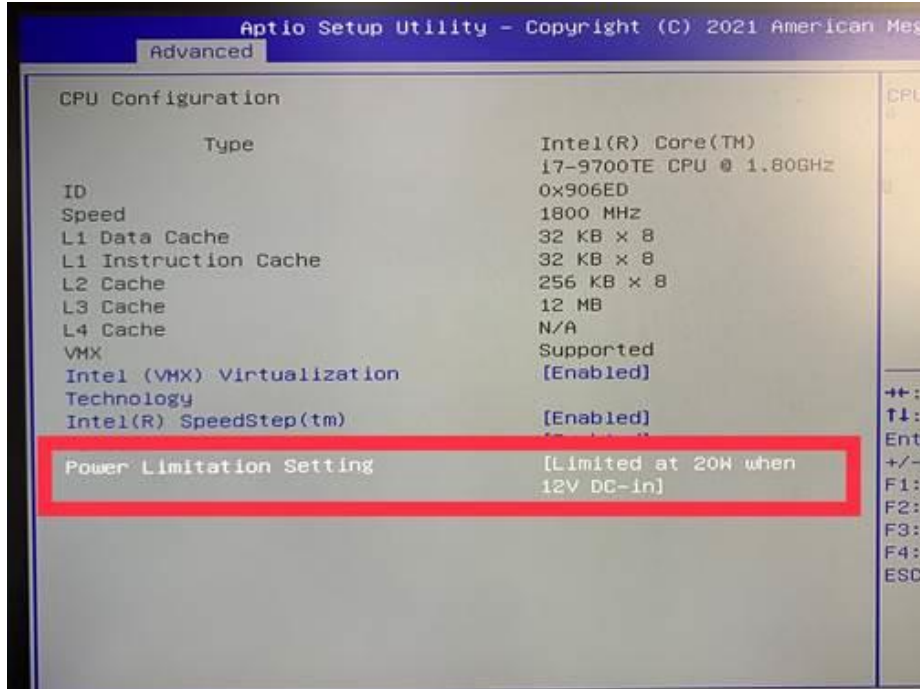

3.4.6 SATA Configuration

This screen allows users to select options for SATA Configuration, and change the value of the selected option.

SATA Controller

Highlight this item to enable or disable SATA Controller.

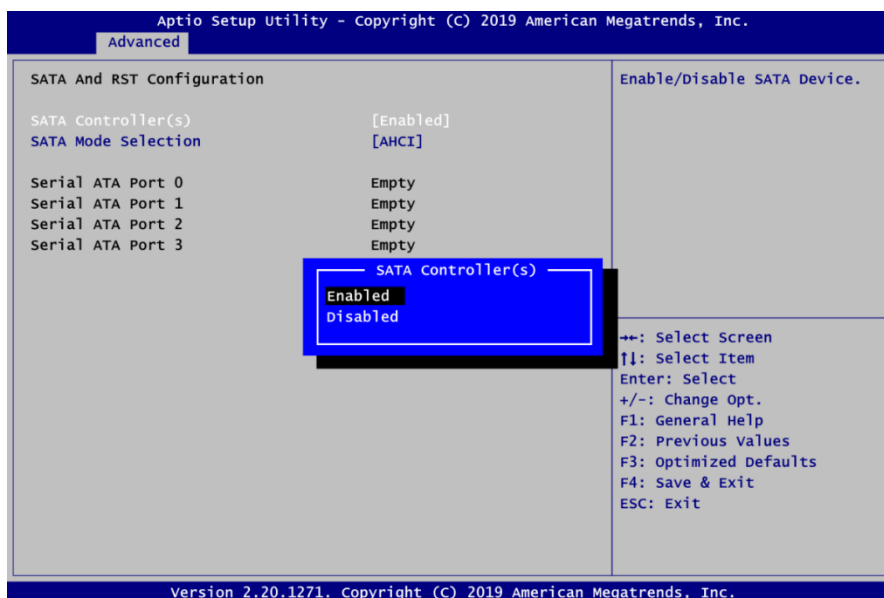

SATA Mode Selection

Use this function to determine how SATA controller(s) operate.

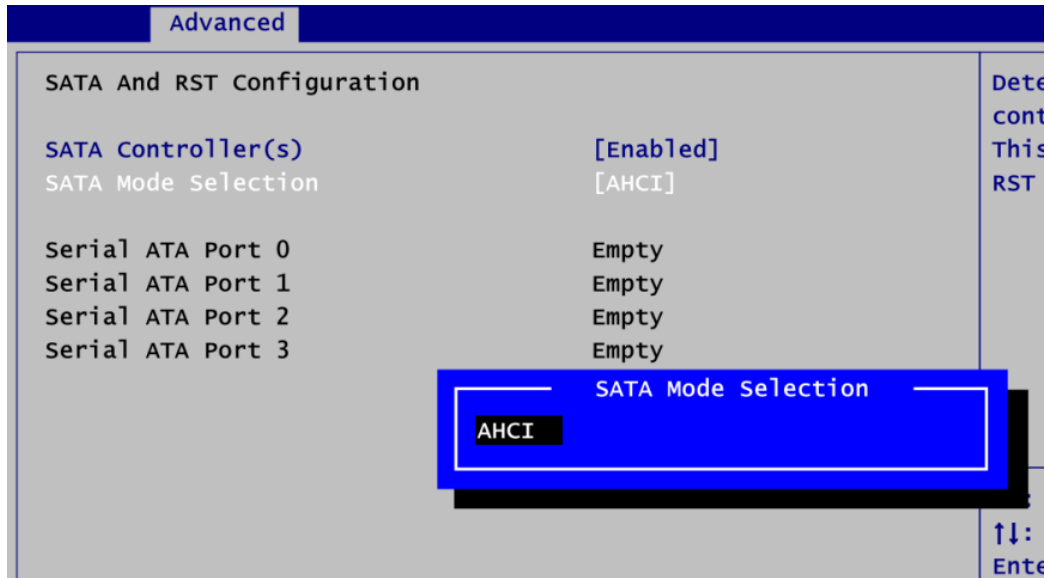

3.4.7 PCH-FW Configuration

This screen displays ME Firmware information.

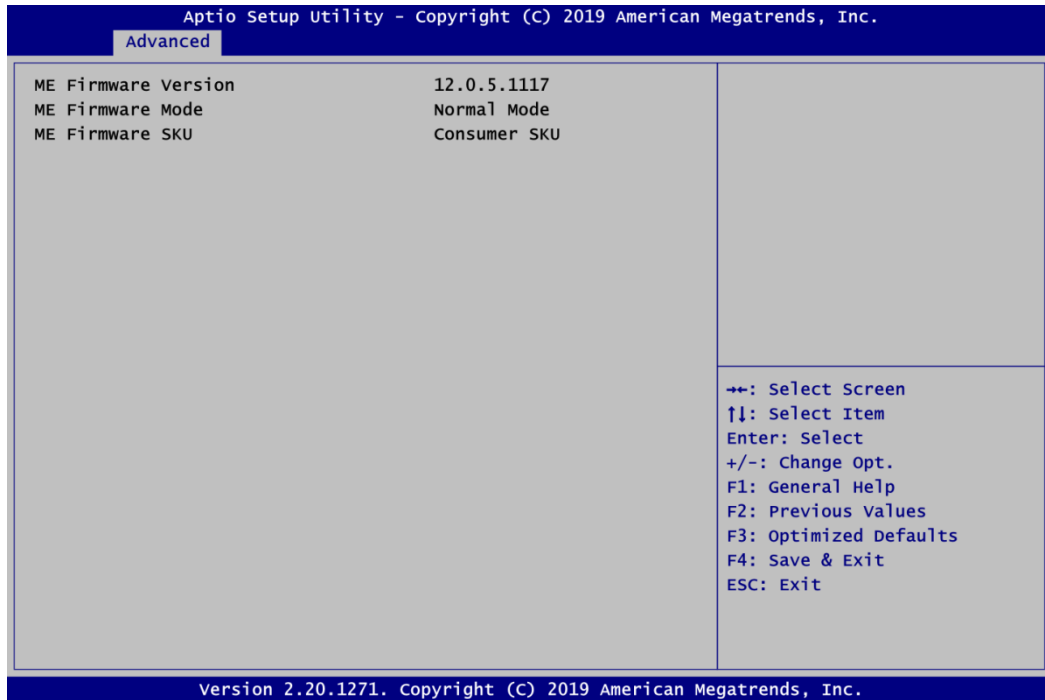

3.4.8 USB Configuration

Display all detected USB devices.

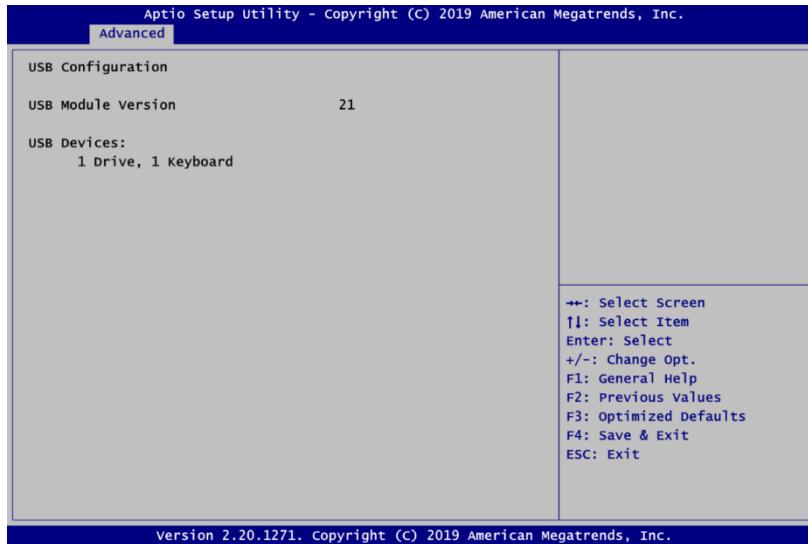

3.5 Chipset Menu

The Chipset menu allows users to change the advanced chipset settings. You can select any of the items in the left frame of the screen to go to the sub menus:

- ▶ System Agent (SA) Configuration
- ▶ PCH-IO Configuration

For items marked with “▶”, please press <Enter> for more options.

3.5.1 System Agent (SA) Configuration

This screen allows users to configure System Agent (SA) parameters. For items marked with “▶”, please press <Enter> for more options.

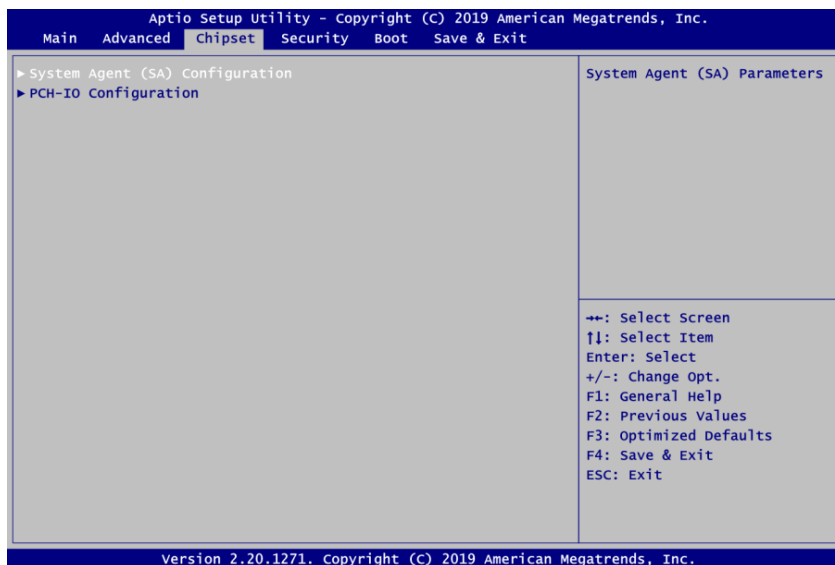

Graphics Configuration

Select to open sub menu for parameters related to graphics configuration.

Memory Configuration

Select to open sub menu for information related to system memory.

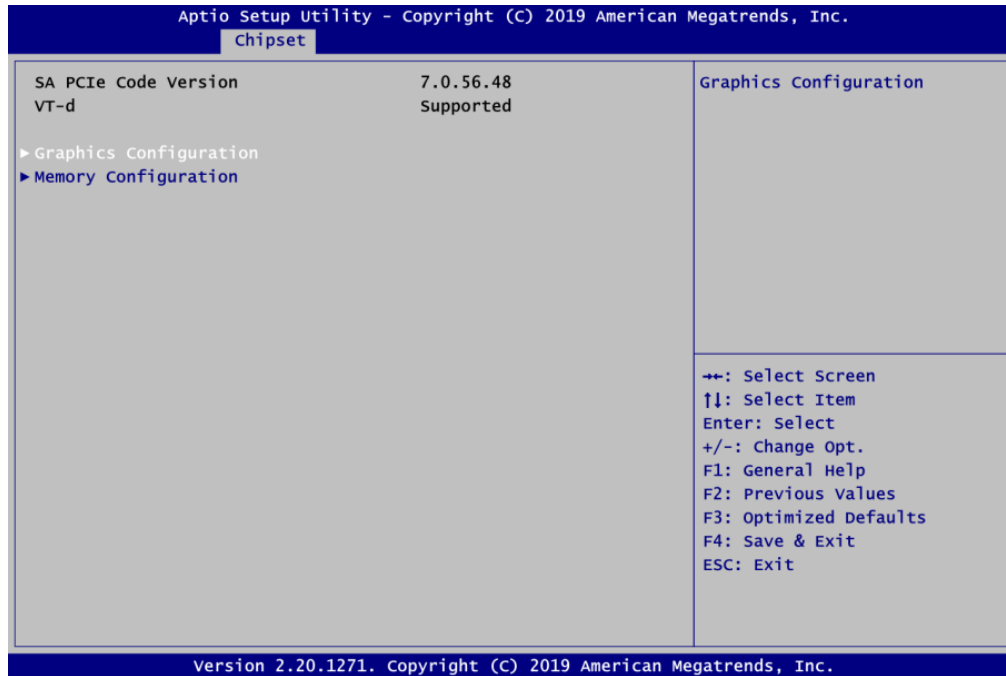

Graphics Configuration

Primary IGFX Boot Display

Select the video device which will be activated during POST (Power-On Self Test). The secondary boot display selection will appear based on your selection.

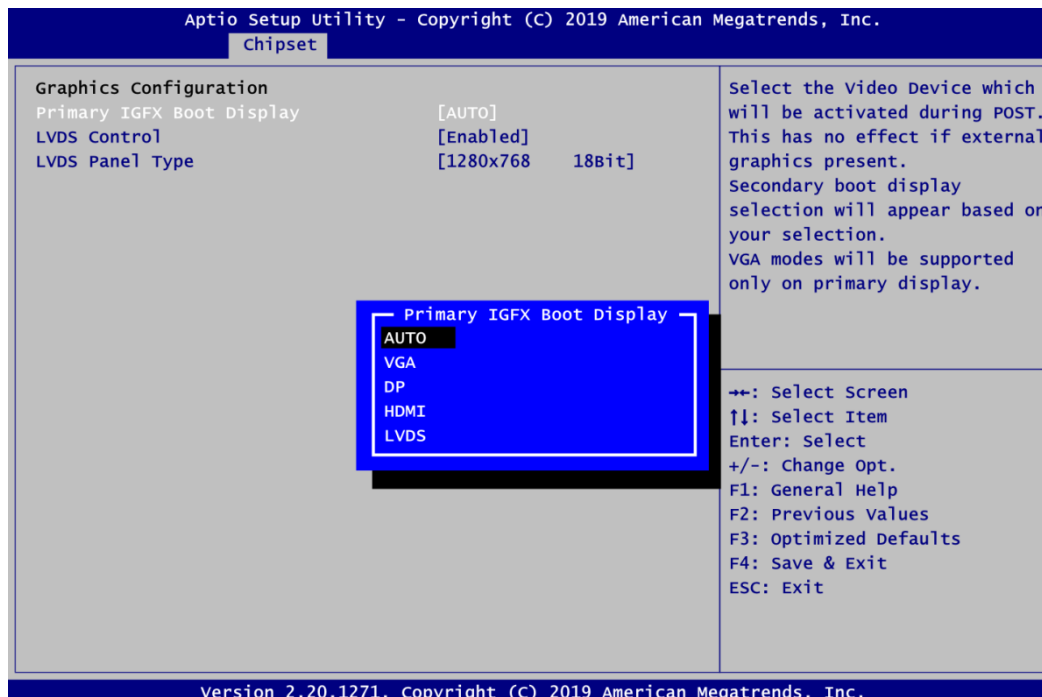

Secondary IGFX Boot Display

After selecting other than "AUTO" on "Primary IGFX Boot Display", the Secondary IGFX Boot Display will show up and its options are DP and HDMI.

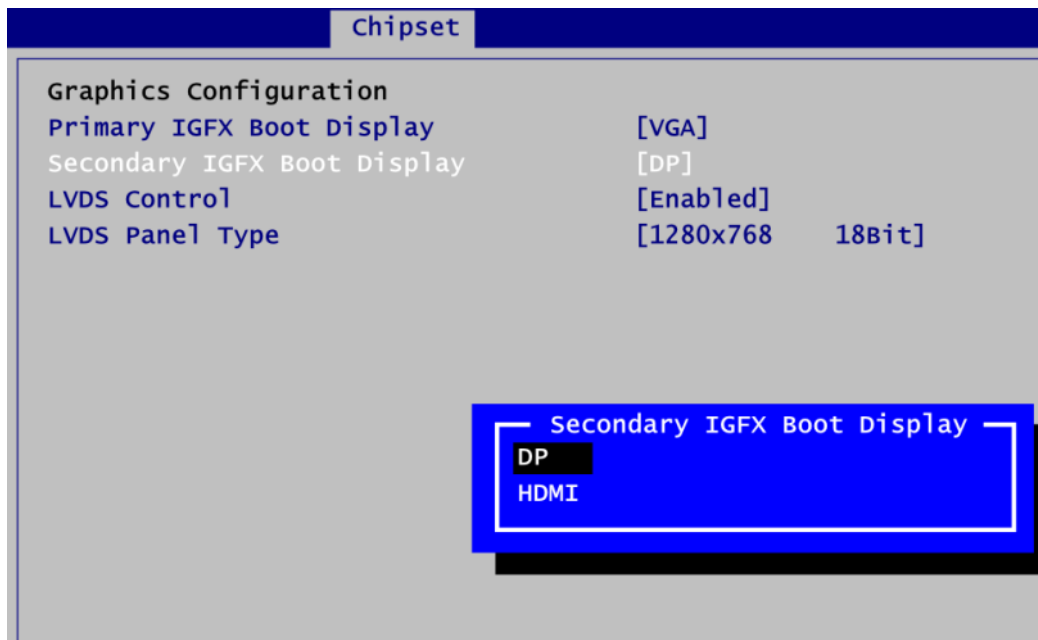

LVDS Control

Enable or disable LVDS Control. When installing Linux OS and if DP, HDMI or VGA display is connected to your system, make sure to set this option to Disabled.

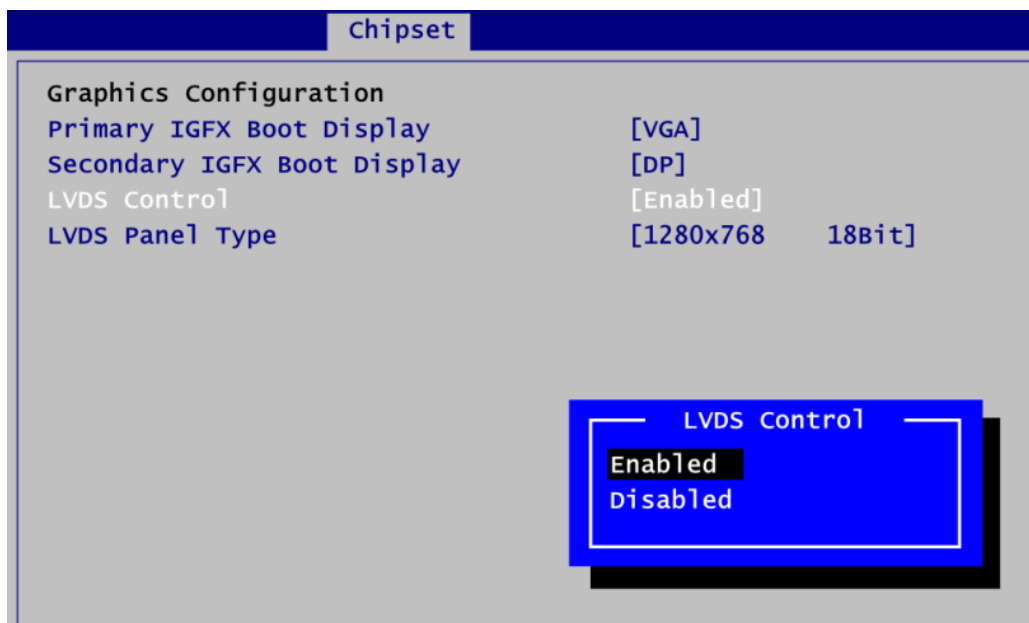

LVDS Panel Type

The resolution of GOT318W-521 is 1920 x 1080 48 bit.

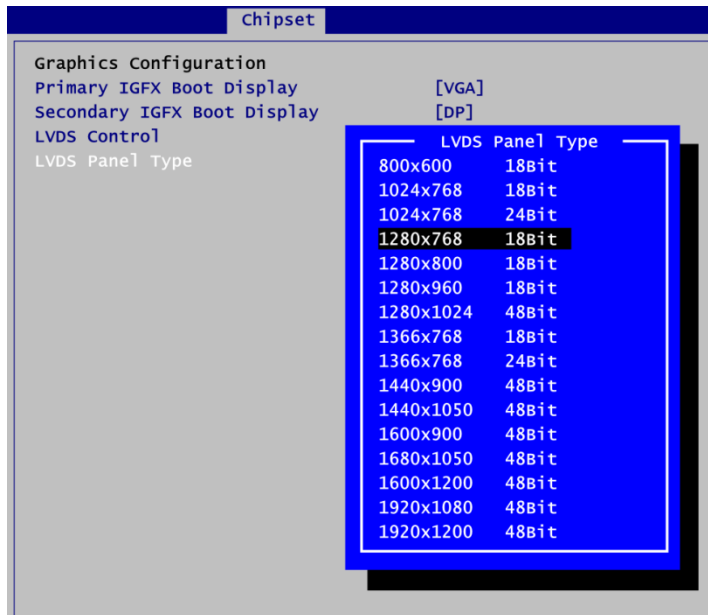

Brightness Setting

This option appears only when LVDS panel is connected. It allows user to adjust the brightness level of the LVDS panel.

- Range: 0~255
- Default: 255

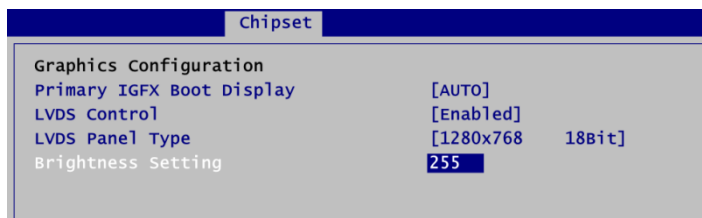

Memory Configuration

This screen shows the system memory information.

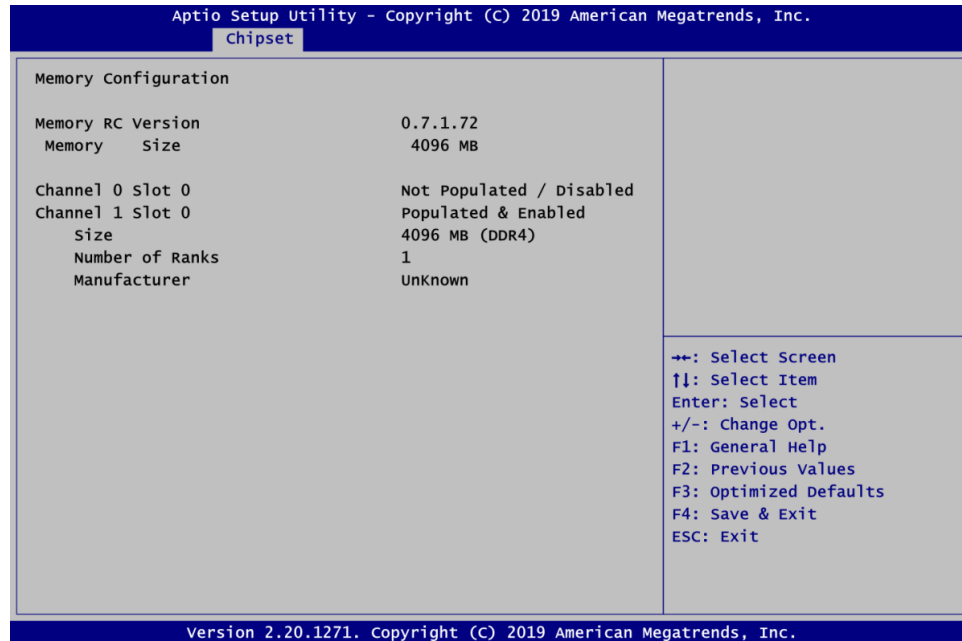

PCH-IO Configuration

This screen allows you to set PCH parameters.

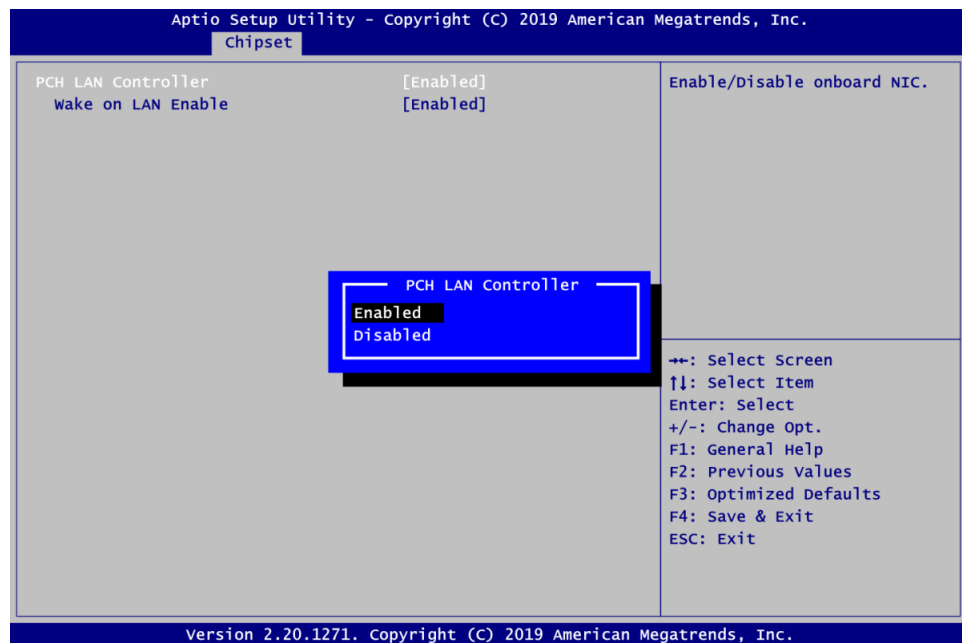

PCH LAN Controller

Enable or disable onboard PCH LAN controller.

Wake on LAN Enable

After enabling PCH LAN Controller, enable or disable integrated LAN to wake the system.

3.6 Security Menu

The Security menu allows users to change the security settings for the system.

- **Administrator Password**
Set administrator password.
- **User Password**
Set user password.

Figure 3-15 Security Menu



3.7 Boot Menu

- Setup Prompt Timeout**
 Number of seconds to wait for setup activation key. 65535(0xFFFF) means indefinite waiting.
- Bootup NumLock State**
 Use this item to select the power-on state for the keyboard NumLock.
- Quiet Boot**
 Select to display either POST output messages or a splash screen during boot-up.

The Boot menu allows users to change boot options of the system.

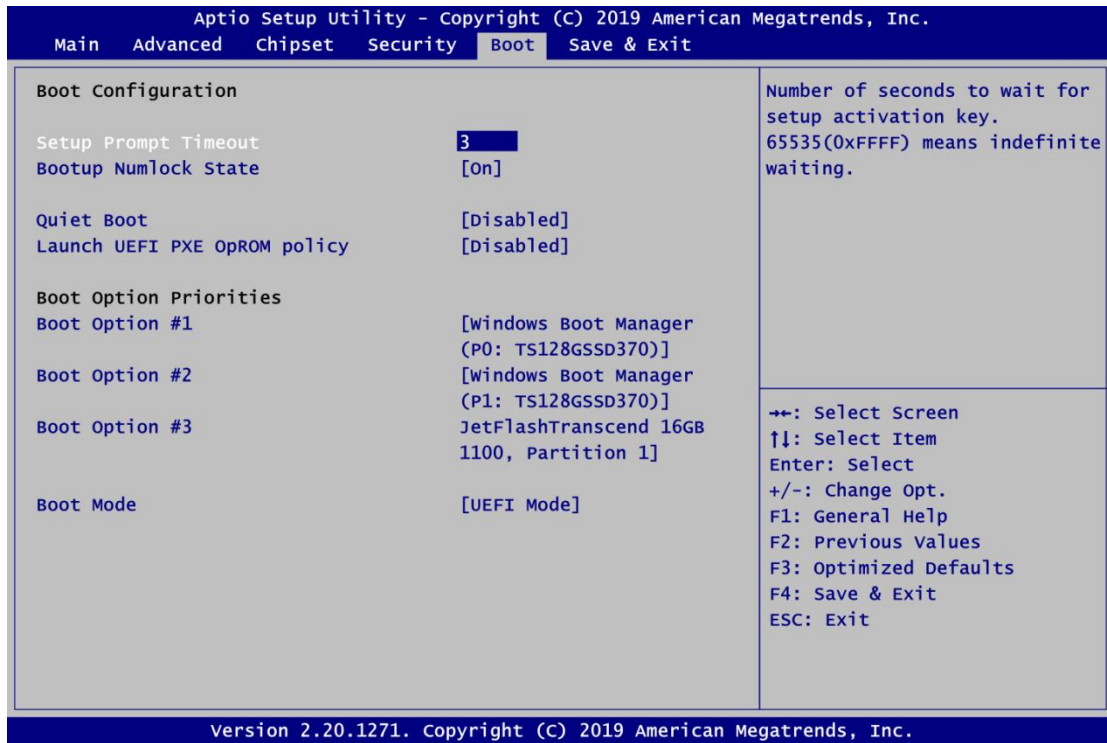

- **Launch UEFI PXE OpROM policy**

Control the execution of UEFI PXE OpROM. When enabled, you may select I219, I211 or Disabled as PXE LAN port.

- **Boot Option Priorities**

These are settings for boot priority. Specify the boot device priority sequence from the available devices.

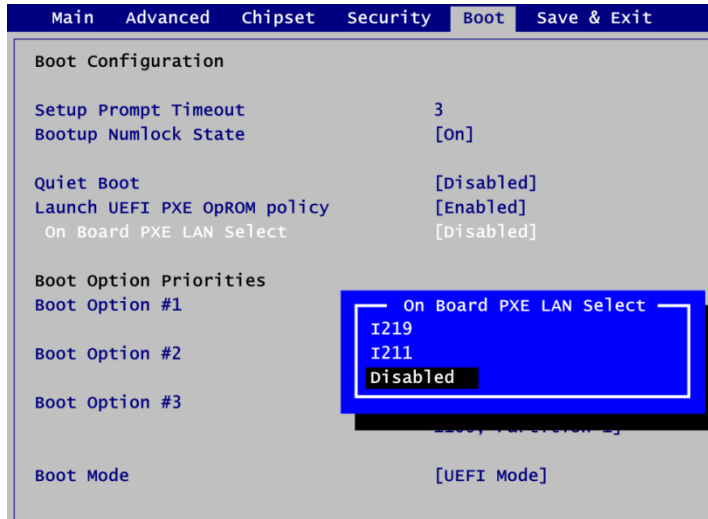

- **Boot Mode**

Use this option for boot mode settings.

- UEFI Boot: Select support to boot any UEFI-capable OS.
- Legacy Boot: Select support to boot non UEFI-capable OS that requires a legacy BIOS interface.

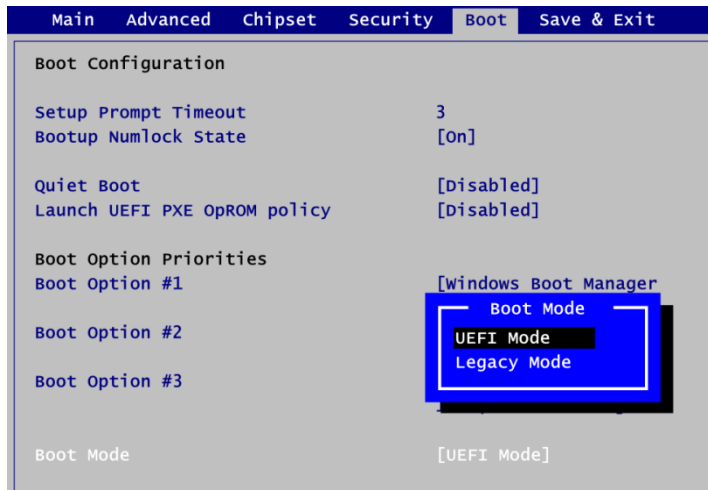

3.8 Save & Exit Menu

The Save & Exit menu allows users to load your system configuration with optimal or fail-safe default values.

Figure 3-17 Save & Exit Menu

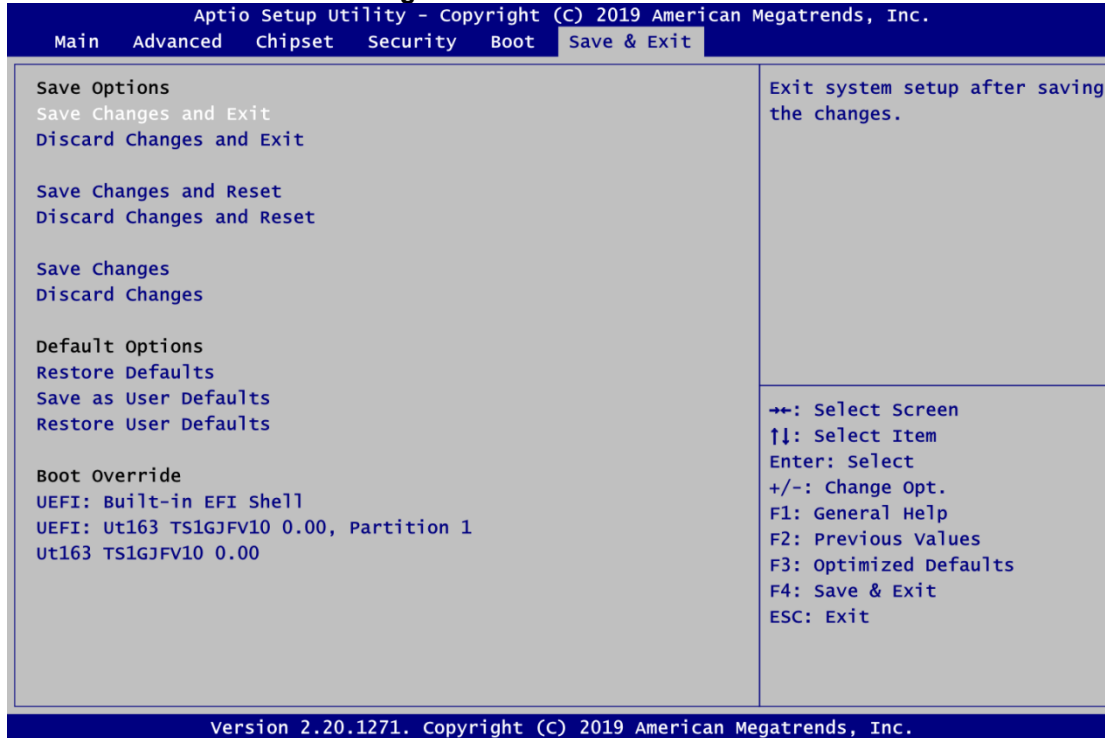

- Save Changes and Exit**
When you have completed the system configuration changes, select this option to leave Setup and return to Main Menu. Select Save Changes and Exit from the Save & Exit menu and press <Enter>. Select Yes to save changes and exit.
- Discard Changes and Exit**
Select this option to quit Setup without making any permanent changes to the system configuration and return to Main Menu. Select Discard Changes and Exit from the Save & Exit menu and press <Enter>. Select Yes to discard changes and exit.
- Save Changes and Reset**
When you have completed the system configuration changes, select this option to leave Setup and reboot the computer so the new system configuration parameters can take effect. Select Save Changes and Reset from the Save & Exit menu and press <Enter>. Select Yes to save changes and reset.
- Discard Changes and Reset**
Select this option to quit Setup without making any permanent changes to the system configuration and reboot the computer. Select Discard Changes and Reset from the Save & Exit menu and press <Enter>. Select Yes to discard changes and reset.
- Save Changes**
When you have completed the system configuration changes, select this option to save changes. Select Save Changes from the Save & Exit menu and press <Enter>. Select Yes to save changes.

- **Discard Changes**
Select this option to quit Setup without making any permanent changes to the system configuration. Select Discard Changes from the Save & Exit menu and press <Enter>. Select Yes to discard changes.
- **Restore Defaults**
It automatically sets all Setup options to a complete set of default settings when you select this option. Select Restore Defaults from the Save & Exit menu and press <Enter>.
- **Save as User Defaults**
Select this option to save system configuration changes done so far as User Defaults. Select Save as User Defaults from the Save & Exit menu and press <Enter>.
- **Restore User Defaults**
It automatically sets all Setup options to a complete set of User Defaults when you select this option. Select Restore User Defaults from the Save & Exit menu and press <Enter>.
- **Boot Override**
Select a drive to immediately boot that device regardless of the current boot order.

SECTION 4

DRIVER and INSTALLATION

4.1 Operating System

The GOT318W-521-PCT is compatible with operating systems Windows 10 and Windows 10 IoT Enterprise. To facilitate the installation of system drivers, please carefully read the instructions in this section before any of such installation.

4.1.1 Driver CD Content

Please download the following GOT312W-521 driver from Axiomtek's official website

- 01.Intel chipset
- 02.Intel Graphic_25.20.100.6615
- 03.Intel Lan_23.2
- 04.Intel ME
- 05.Realtek_Audio_6.0.1.8504
- 06.Intel SeralIO
- 07.Intel IRST

4.2 Touch Screen

The GOT318W-521-PCT adopts a projected capacitive multi-touch screen of which specifications are listed below. The touch driver will be installed automatically to allow the user to operate the touch panel using two-finger touch functions on the Windows 10 and Windows 10 IoT Enterprise environments.

Table 4-1 Touch screen specifications

Touch Screen	Projected capacitive multi-touch
Touch Screen Controller	TPK_USB Touch Screen Controller IC
Communications	USB interface
Power Supply	5V
Power Consumption	<100mA +10mA
Input Method	Finger or Cap.Stylus
Resolution	25ppi (Min.)_ Note: Based on the WIN7 definition, ppi (pixels per inch)
Win7 USB Driver	Non-Driver
Calibration	Non-Calibration

APPENDIX A

WATCHDOG TIMER

A.1 About Watchdog Timer

Software stability is a major issue in most application. Some embedded systems are not watched by human for 24 hours. It is usually too slow to wait for someone to reboot when computer hangs. The systems need to be able to reset automatically when things go wrong. The watchdog timer gives us solutions in this regard.

The watchdog timer is a counter that triggers a system reset when it counts down to zero from a preset value. The software starts counter with an initial value and must reset it periodically. If the counter ever reaches zero which means the software has crashed, the system will reboot.

A.2 Sample Program

1. Enter **ADU**, and press <F4> to select the **superior ITE**
2. **PORT** setting **002E**, **002F**
3. Address **07h** setting **07 GPIO**
4. Address **72h** to set the countdown, for example Sec: **C0**, Min: **40**
5. Address **73h** set the countdown time, for example 10sec: **0A**

This page is intentionally left blank.

APPENDIX B

iAMT SETTINGS

Utilizing built-in platform capabilities and popular third-party management and security applications, the Intel® Active Management Technology (Intel® iAMT) has significantly lowered a major barrier to IT management efficiency, helping IT professionals discover, repair and better protect their networked computing assets.

In order to utilize Intel® iAMT you must enter the ME BIOS (<Ctrl + P> during system startup), change the ME BIOS password, and then select “Intel® iAMT” as the manageability feature.

B.1 Entering MEBx

1. You must go to BIOS to enable iAMT function.
2. Exit from BIOS after starting iAMT, and press <Ctrl + P> to enter MEBx Setting.

**NOTE**

Press <Ctrl + P> before the screen pops out.

B.2 Set and Change Password

1. You will be asked to set a password when first logging in. The default password is “admin”.

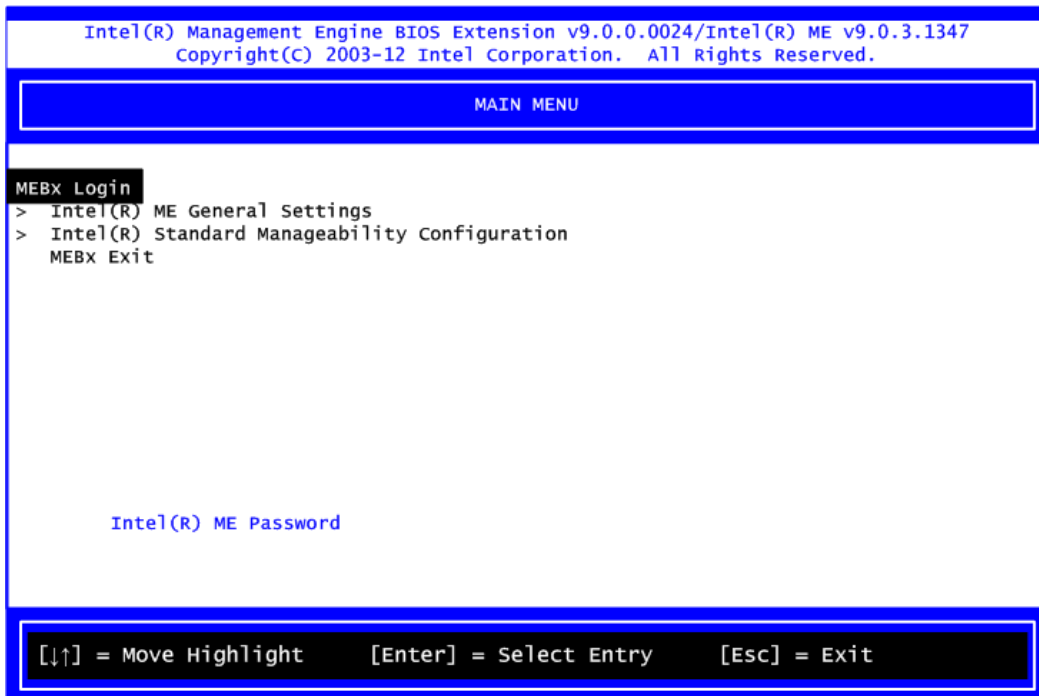

- You will be asked to change the password before setting ME.

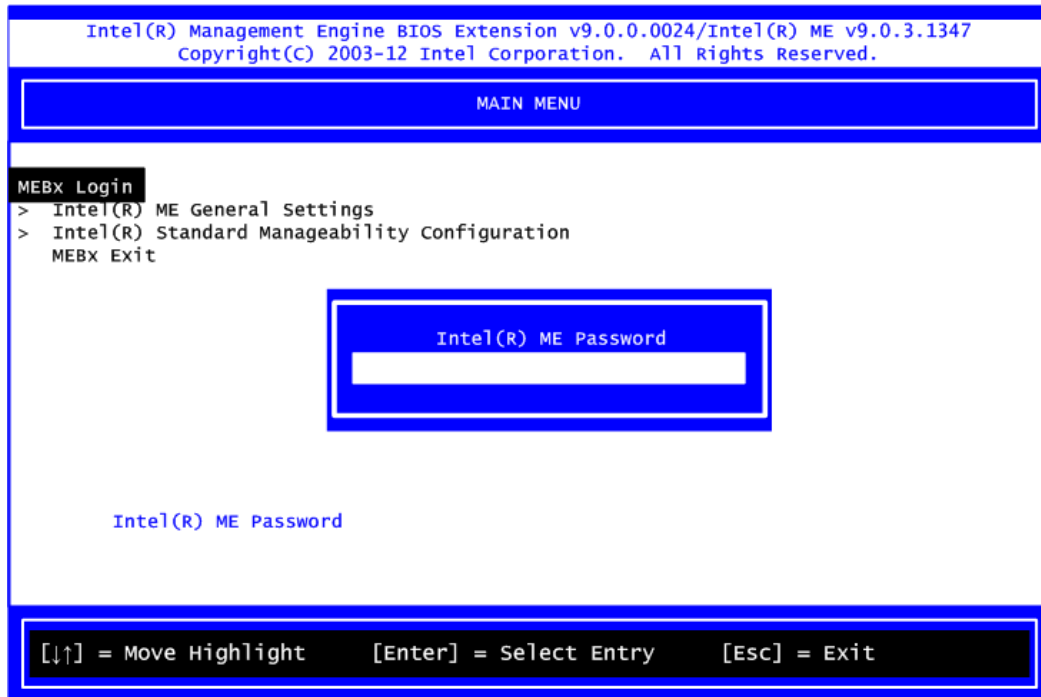

- You must confirm your new password while revising. The new password must consist of eight characters, including at least:
 - One upper case
 - One lower case
 - One number
 - One special symbol, such as ! \$ or ; , (except \ " ,)

The default value demonstrates an example of a valid password: **!!11qqQQ**

Underline () and space are valid characters, but they won't increase password strength.

B.3 iAMT Settings

1. Select Intel® iAMT configuration and press <Enter>.

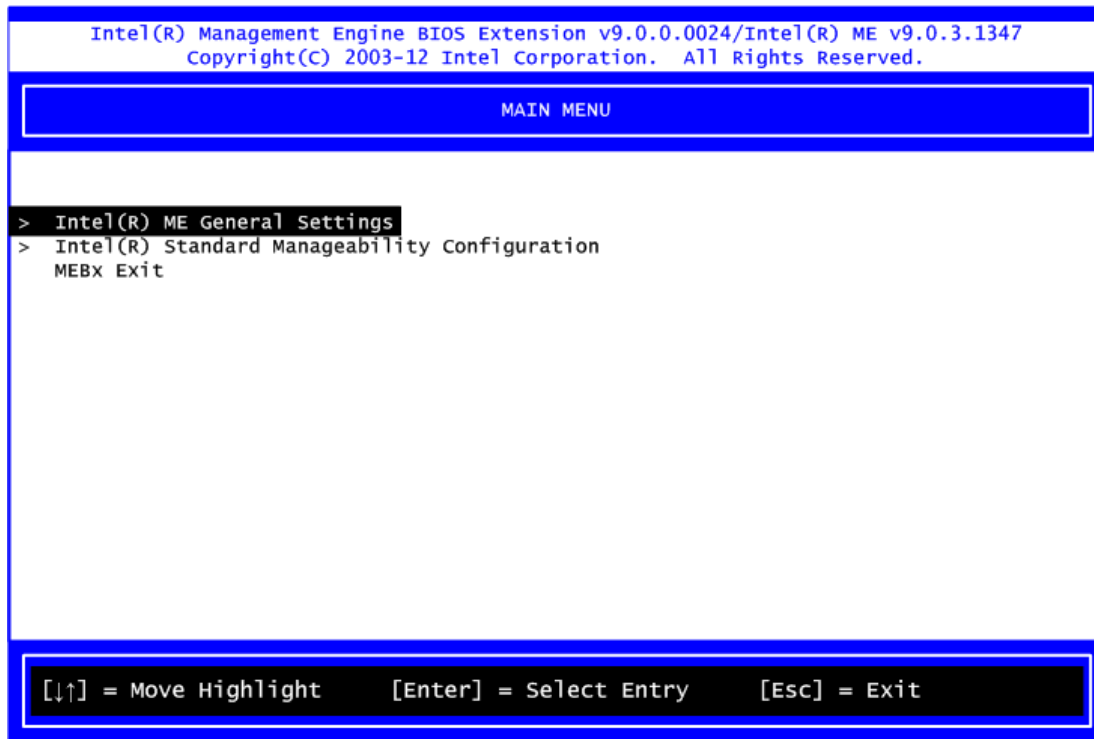

2. Select Network Setup to configure iAMT.

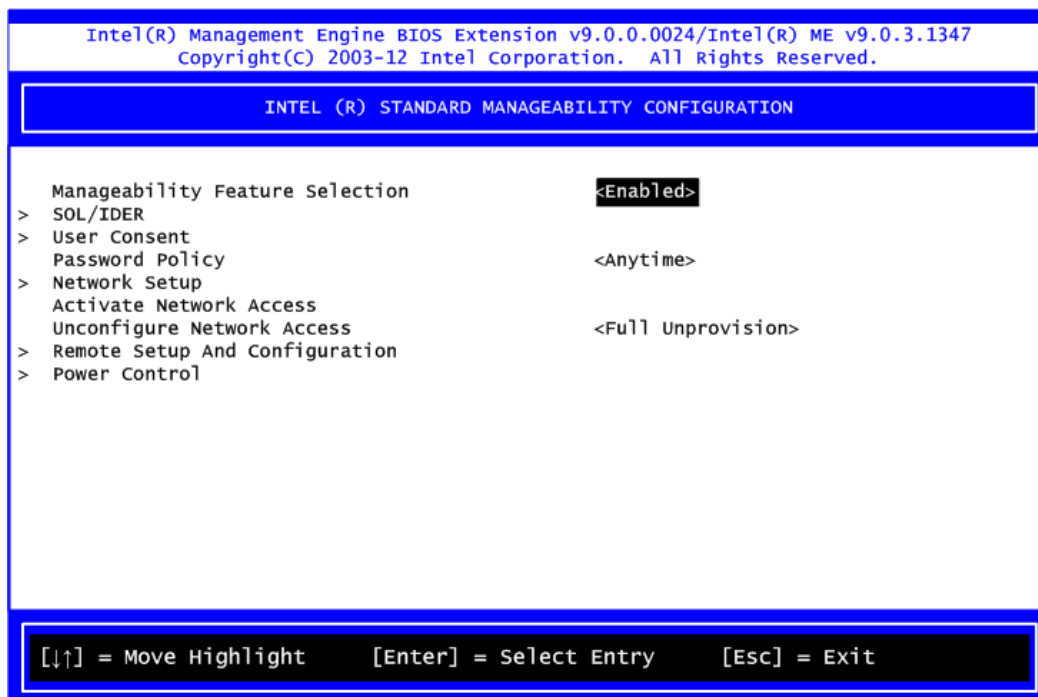

3. Select TCP/IP to enter the Network Setup menu. Select DHCP Mode and set it to Disabled.

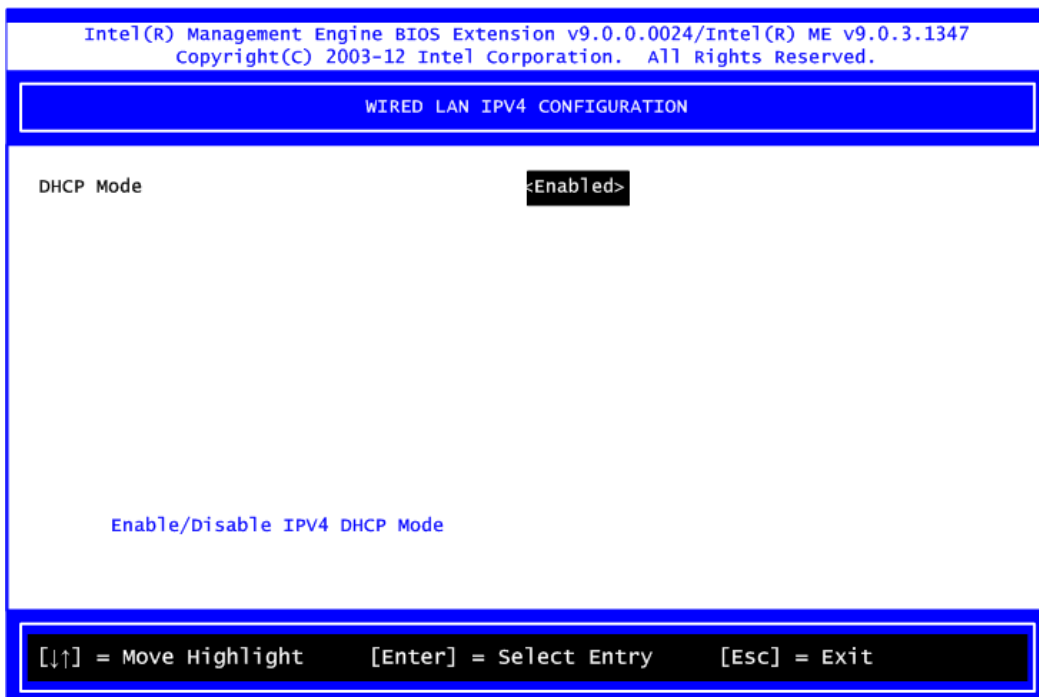
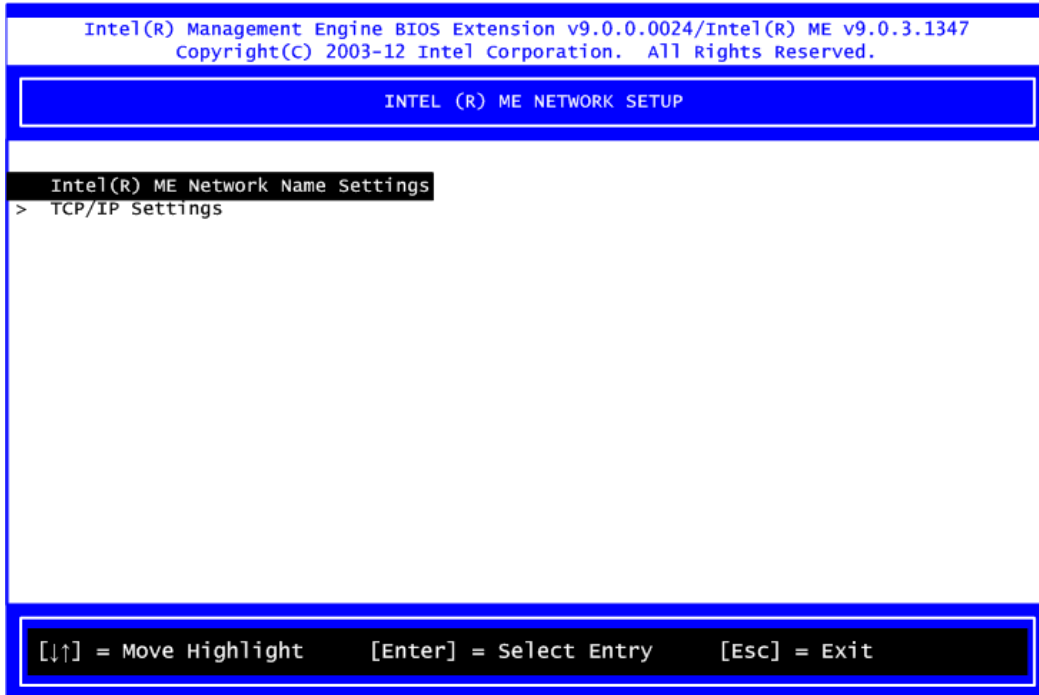

4. If DHCP Mode is disabled, set the following settings:

- IP address
- Subnet mask

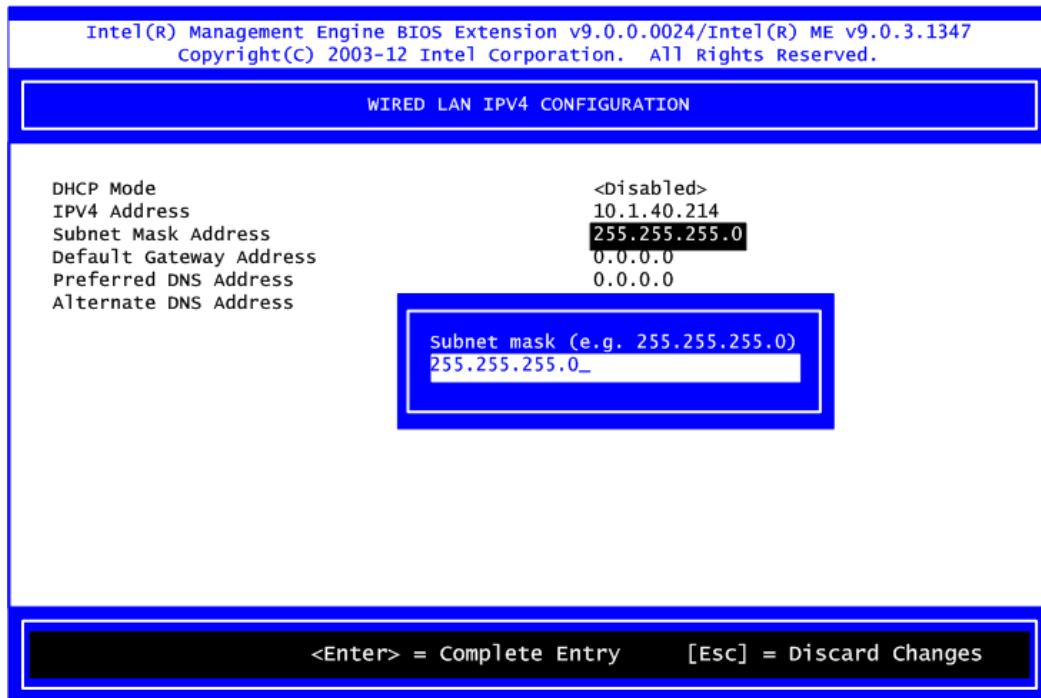

5. Return to Intel® iAMT Configuration, then select Activate Network Access and press <Enter>.

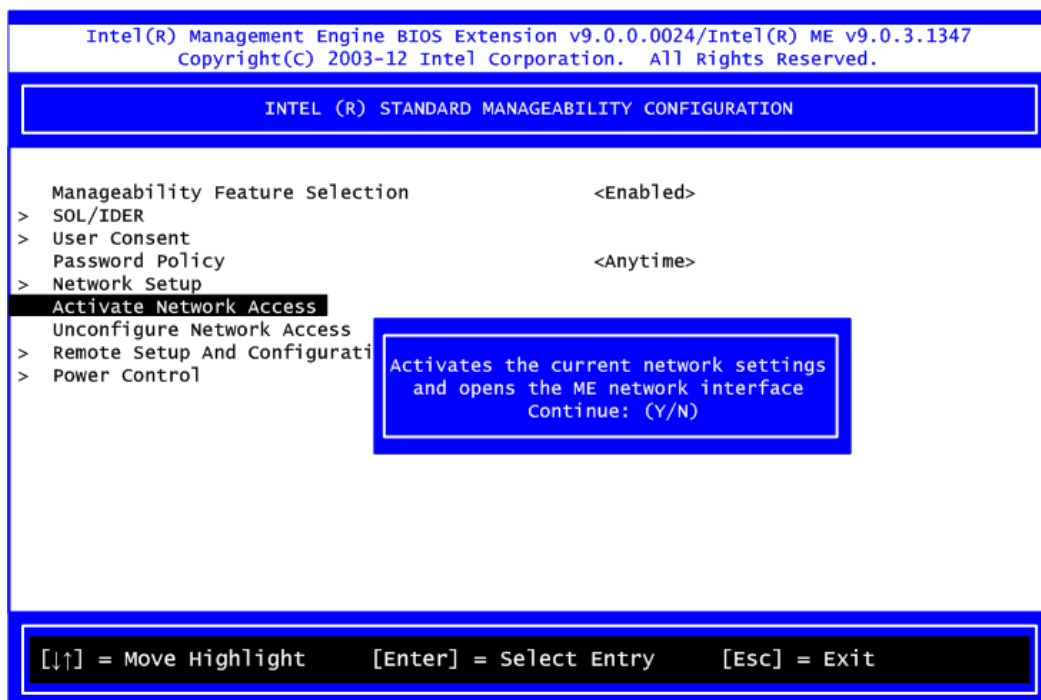

6. Exit from MEBx after completing the iAMT settings.

B.4 iAMT Web Console

1. On a web browser, type `http://(IP ADDRESS):16992`, which connects to iAMT Web.

Example: <http://10.1.40.214:16992>

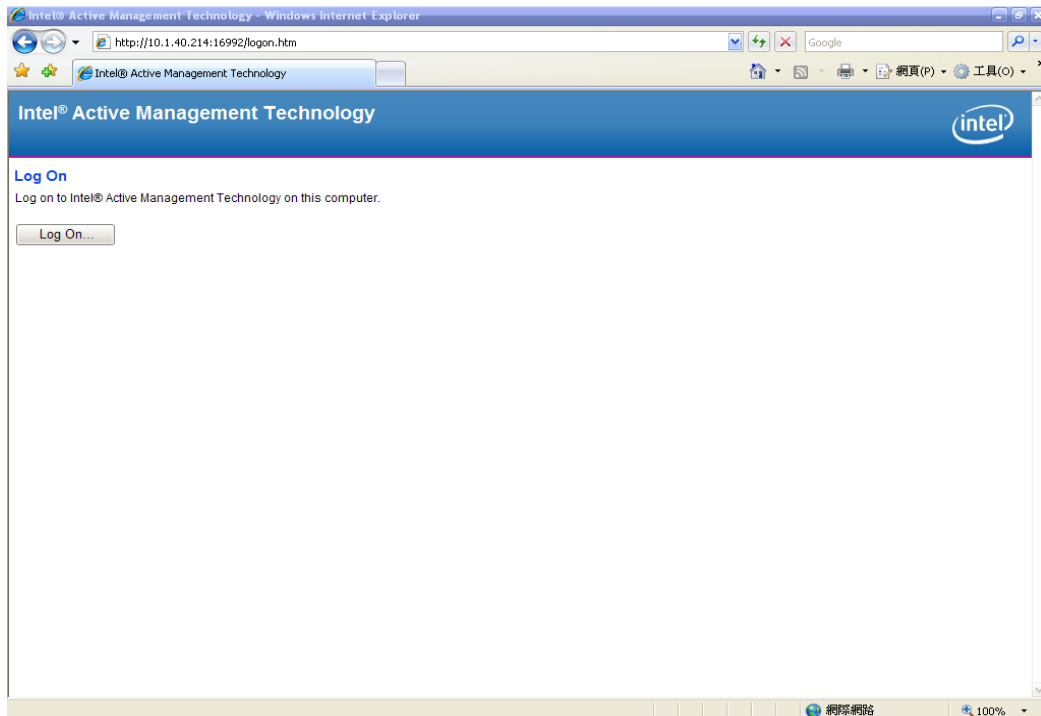

2. To log on, you will be required to type in your username and password for access to the Web.

USER: admin (default value)
PASS: (MEBx password)

3. Enter the iAMT Web.

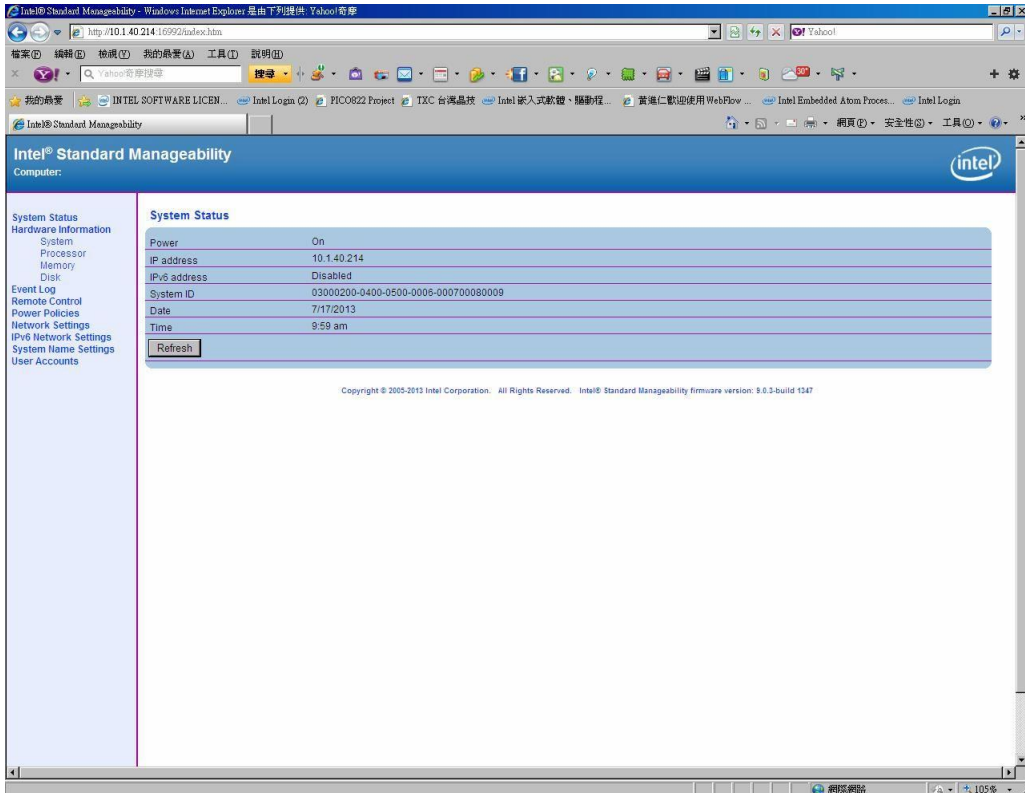

4. Click Remote Control, and select commands on the right side.

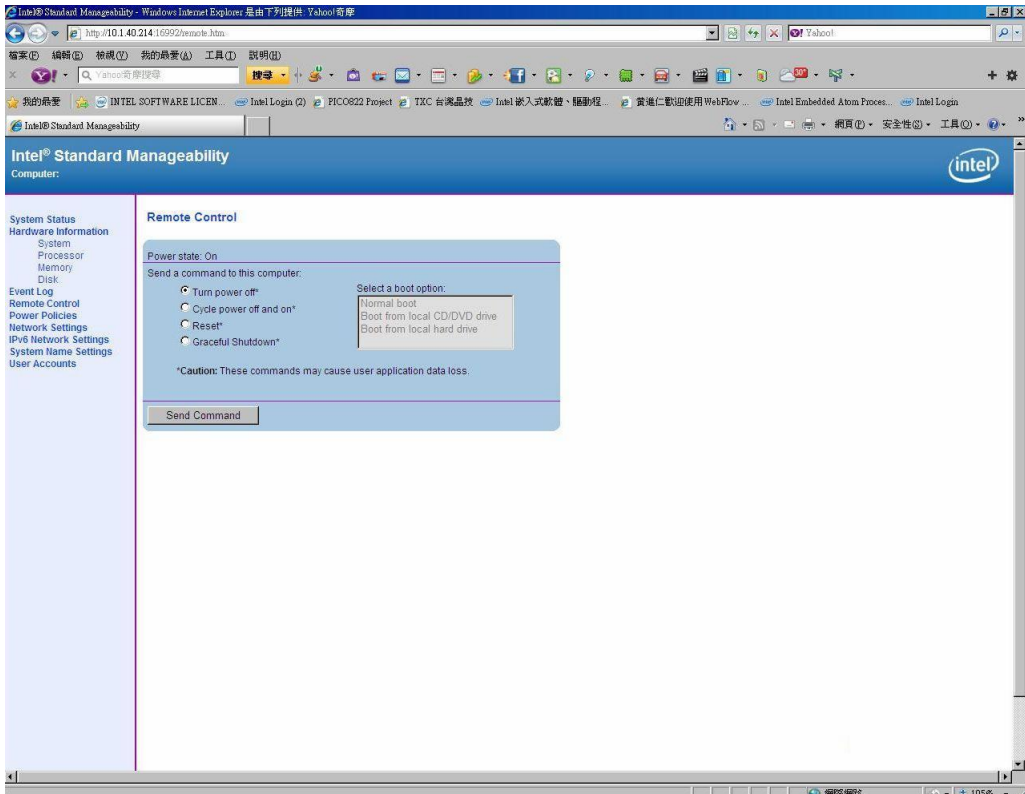

5. When you have finished using the iAMT Web console, close the Web browser.

This page is intentionally left blank.