

USER'S MANUAL

GOT315W-521-PCT

All-in-One
15.6" WXGA TFT Fanless
PCT Multi-Touch PANEL PC

User's Manual



www.axiomtek.com

Disclaimers

This manual has been carefully checked and believed to contain accurate information. Axiomtek Co., Ltd. assumes no responsibility for any infringements of patents or any third party's rights, or any liability arising from such uses.

Axiomtek does not warrant or assume any legal liability or responsibility for the accuracy, completeness or usefulness of any information in this document. Axiomtek does not make any commitment to update any information in this manual.

Axiomtek reserves the right to change or revise this document and/or product at any time without notice.

No part of this document may be reproduced, stored in a retrieval system, or transmitted in any forms or by any means, electronic, mechanical, photocopying, recording, among others, without prior written permission from Axiomtek Co., Ltd.

CAUTION

Wrong type of batteries may cause explosion. It is recommended that users only replace with the same or equivalent type of batteries as suggested by the manufacturer once properly disposing of any used ones.

©Copyright 2020 Axiomtek Co., Ltd.

All Rights Reserved

Sep 2020, Version A1

Printed in Taiwan

Safety Precautions

Before getting started, please read the following important safety precautions.

1. Be sure to ground yourself to prevent static charge when installing any internal components. Use a grounding wrist strap and place all electronic components in any static-shielded devices. Most electronic components are sensitive to static electrical charge.
2. Disconnect the power cord from the GOT315W-521-PCT series prior to any installation. Be sure both the system and all external devices are turned off. Sudden surge of power could ruin sensitive components. Make sure the GOT315W-521-PCT Series is properly grounded.
3. Do not open the system's back cover. If opening the cover for maintenance is a must, only a trained technician is allowed to do so. Integrated circuits on computer boards are sensitive to static electricity. To avoid damaging chips from electrostatic discharge, observe the following precautions:
 - Before handling a board or integrated circuit, touch an unpainted portion of the system unit chassis for a few seconds. This will help to discharge any static electricity on human body.
 - When handling boards and components, wear a grounding wrist strap available from most electronic component stores.

Trademark Acknowledgments

Axiomtek is a trademark of Axiomtek Co., Ltd.

Intel® and Pentium® are registered trademarks of Intel Corporation.

Windows 10, Windows 10 IoT Enterprise are trademarks of Microsoft Corporation.

Other brand names and trademarks are the properties and registered brands of their respective owners.

Table of Contents

Disclaimers.....	ii
Safety Precautions.....	iii
Section 1 Introduction.....	1
1.1 General Descriptions	1
1.2 Specifications.....	2
1.3 Dimensions and Outlines	4
1.4 I/O Outlets	6
1.5 Packing List	7
Section 2 Hardware and Installation	9
2.1 Board Layout	9
2.2 Jumper and Connector Settings.....	10
2.2.1 Restore BIOS Optimal Defaults Jumper (JP4).....	10
2.2.2 Auto Power On Jumper (JP6)	11
2.2.3 COM Port Connector.....	11
2.3 Ethernet Connector.....	12
2.4 Mounting Methods	13
2.5 Hardware Installation	15
2.5.1 Installing a HDD	15
2.5.2 Installing a DRAM.....	16
2.5.3 Installing a CPU.....	17
2.5.4 Connecting the Power Input.....	18
Section 3 AMI BIOS Setup Utility	19
3.1 Navigation Keys	19
3.2 Main Menu.....	20
3.3 Advanced Menu.....	21
3.3.1 IT8625 Super IO Configuration	22
3.3.2 Hardware Monitor	24
3.3.3 Trusted Computing	25
3.3.4 ACPI Setting	27
3.3.5 CPU Configuration.....	28
3.3.6 SATA Configuration.....	29
3.3.7 PCH-FW Configuration.....	30
3.3.8 USB Configuration.....	30
3.4 Chipset Menu.....	31

3.4.1 System Agent (SA) Configuration.....	31
3.5 Security Menu.....	35
3.6 Boot Menu.....	36
3.7 Save & Exit Menu	38
Section 4 Driver and Installation	41
4.1 Operating System	41
4.1.1 Driver CD Content.....	41
4.2 Touch Screen.....	42
Appendix A Watchdog Timer.....	43
A.1 About Watchdog Timer	43
A.2 Sample Program.....	43
Appendix B iAMT Settings	45
B.1 Entering MEBx.....	45
B.2 Set and Change Password	45
B.3 iAMT Settings	47
B.4 iAMT Web Console.....	50
Appendix C TPM Settings.....	53

This page is intentionally left blank.

Section 1

Introduction

This Section contains general information and detailed specifications of the GOT315W-521-PCT, including the following subsections:

Figure 1-1 Front panel of the GOT315W-521-PCT



- General Descriptions
- Specifications
- Dimensions and Outlines
- I/O Outlets
- Packing List

1.1 General Descriptions

The GOT315W-521-PCT adopts a 15.6-inch WXGA TFT LCD with 400-nit brightness and support the 8th Gen Intel® Core® Processor Coffee Lake-S i5-8500T(Tj 100°C) or GS5400T(Tj 100/88°C), up to 35W, providing excellent computing performance and thermal resistance. This fanless platform is especially designed for operation under a harsh environment including steel refinery, oil pipe, ship, machine maker, and many more. Having abilities below surely makes GOT315W-521-PCT a most robust and cost-effective solution.

- **Design for extended operating temperature range and ingress protection**

The GOT315W-521-PCT is featured by a technology to sustain extended operating temperature range between 0°C and +50°C by incorporating compact ID and fanless cooling system with 8th Gen Intel® Core® Processor Coffee Lake-S i5-8500T(Tj 100°C) or GS5400T(Tj 100/88°C) up to 35W. It also adopts an IP65 front bezel to protect itself from liquid and dust. These designs help make the system a power-efficient solution.

- **Reliable and stable design**

The GOT315W-521-PCT– is specially designed for vibration-prone environments, best for the transportation (vehicle, railway, marine) and industrial machinery markets. To suit the need of high capacity storage, the GOT315W-521-PCT can work in operation mode under 1.0G (10 ~ 500Hz) with a patent of anti-vibration design. The design behind the patent has improved the system reliability and sustainability. (Note: Sometimes heavy-vibration may cause the LCD screen to flash in white color; however, it won't affect the function of the product.)

- **WLAN antenna supported (optional)**

The GOT315W-521-PCT comes with 2 Mini Card slots as an add-on option to connect a wireless LAN card under 802.11 a/b/g/n protocols, or with other 3G/GPRS applications, etc. These slots also come with 3 optional fixed rotational WLAN/3G antennas for wireless network connection.

- **Multi-Touch PCAP touch with 3H surface hardness**

The GOT315W-521-PCT is designed with a user friendly multi- PCAP touch. Users can operation it with direct touch. The surface hardness is up to 3H, good for applications of anti-scratch purpose.

- **Other features**

The GOT315W-521-PCT utilizes one 260-pin DDR4-2133/2400 SODIMM system memory up to 32GB at the maximum, one 2.5" wide temperature SATA HDD/SSD. It provides a full set of I/O including RS-232/422/485, USB 2.0, USB 3.0, audio (line-out), HDMI out, DP out, VGA out, and Gigabit Ethernet. Additionally, this slim unit supports panel mount as the standard installation, as well as optionally wall mount, VESA mount and desktop stand mount.

1.2 Specifications

Main CPU Board

- **CPU**
- **8th Gen Intel® Core™ processor up to 35W**
 - Coffee Lake-S i5-8500T Tj 100°C
 - Coffee Lake-S G5400T Tj 100/88°C
- **System Memory**
 - 1 x DDR4 2133/2400MHz SO-DIMM socket
 - Maximum memory up to 32GB
- **BIOS**
 - AMI UEFI BIOS

I/O System

- **Standard I/O**
 - 1 x 9-pin D-sub Male / Via cable(option) for RS-232
 - 1 x COM for RS-232/422/485
 - 2 x USB 2.0
 - 2 x USB 3.0
 - 1 x Switch for power on/off
 - 1 x HDMI output
 - 1 x DP output
 - 1 x VGA output
- **Ethernet**
 - 2 x RJ45 for Gigabit Ethernet (Intel i211AT)
- **Audio**
 - 1x Line-out

- **Expansion**
 - 1 x M.2 Key E slot
 - 1 x Full size Mini-card slot
- **Storage**
 - 1 x 2.5" wide temperature SATA HDD/SSD (support 7mm and 9.5mm, removable)
- **Power connector**
 - 1x Phoenix power connector for DC power input

System Specifications

- **15.6" WXGA (1366x768) LCD with LED backlight**
- **Projected capacitive multi-touch**
- **A design of fanless heat dispensation**
- **IP65 aluminum front bezel**
- **Storage:**
 - 1 x 2.5" SATA HDD/SSD (support 7mm and 9.5mm, removable)
- **Weight(Net/Gross)**
 - 6.5 kg(14.3 lb)/8.5kg(18.7 lb)
- **Dimensions (of the main body)**
 - 396.8 mm (15.6") (W) x 53 mm (2.08") (D) x 247.1 mm (9.73") (H)
- **Operating temperatures**
 - 0°C to 50°C(+32°F to +122°F)
- **Relative humidity**
 - 20% to 90% @ 40°C, Non-condensing
- **System power input**
 - DC power input : 24VDC with small Phoenix power connector



NOTE: *All specifications and images are subject to change without notice.
The performance of the system might be adversely affected at an operating temperature above 40°C.*

1.3 Dimensions and Outlines

Below shows the dimensions and outlines of the front panel of the GOT315W-521-PCT

Front dimensions: 396.8 mm (15.6") (W) x 53 mm (2.08") (D) x 247.1 mm (9.73") (H)

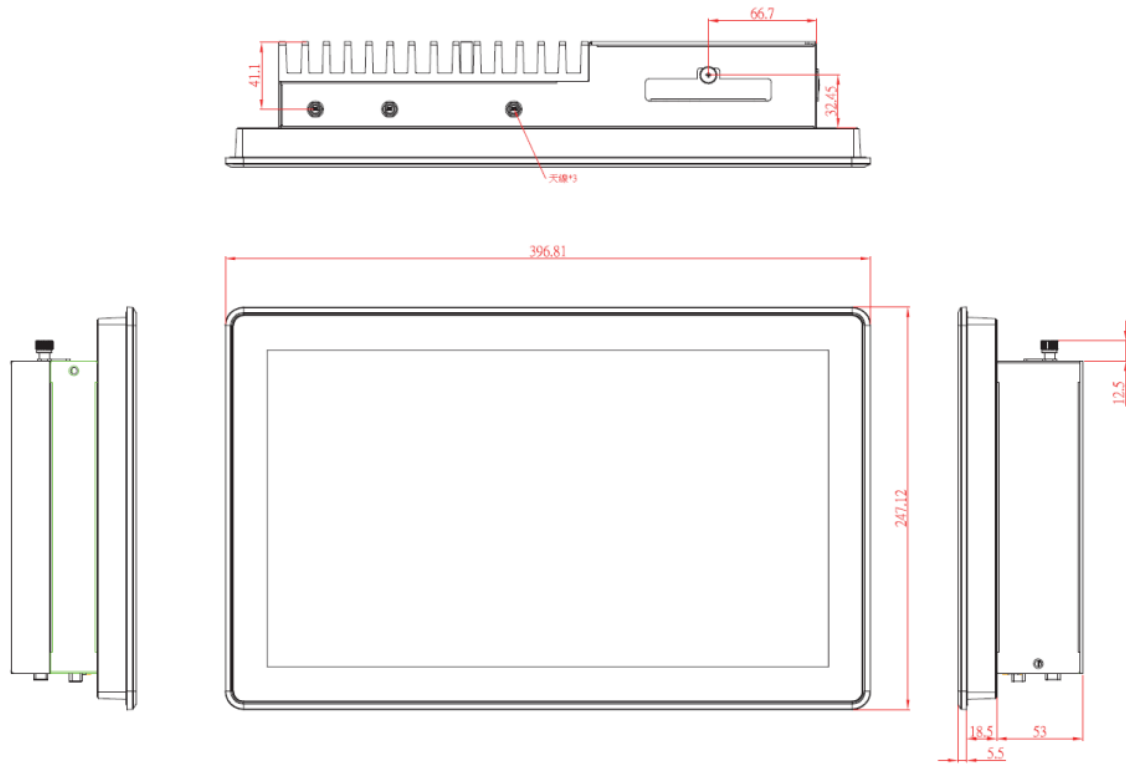

Diagram 1-2 Back outline of the GOT315W-521-PCT

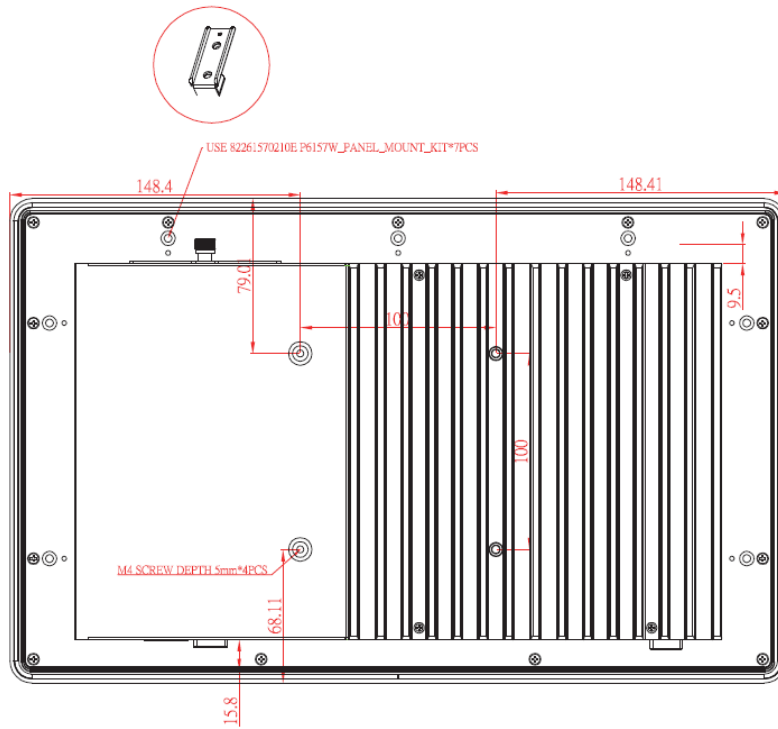

Diagram 1-3 Cutting-out dimensions of the GOT315W-521-PCT



Cut out dimensions: 385.6 x 236.9 mm



NOTE: The limited of wall depth is 9 mm in panel mount.

1.4 I/O Outlets

Please refer to Figures 1-2 and 1-3 for I/O locations of the GOT315W-521-PCT.

Figure 1-2 Bottom view of the GOT315W-521-PCT

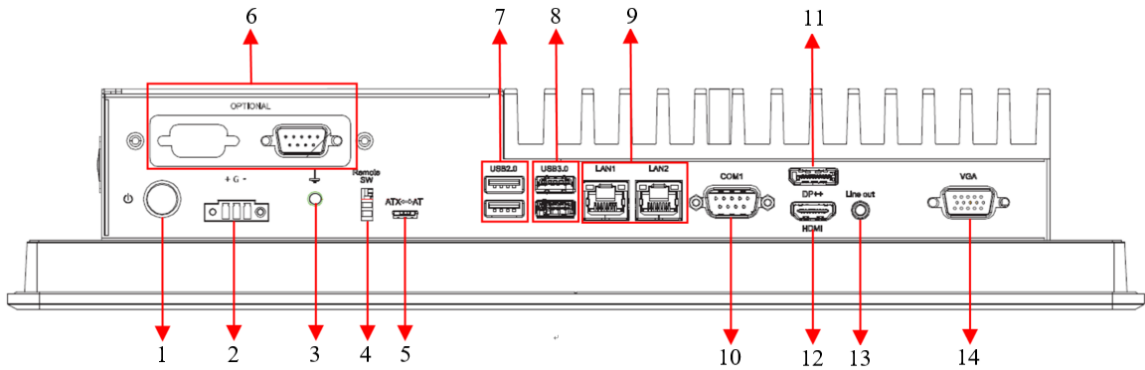

No.	Note.	No.	Note.
1	Power button	8	2x USB3.0
2	Phoenix Small type connector	9	2x RJ-45 for Giga Ethernet
3	Grounding hole	10	1x COM for RS232/422/485
4	Remote power switch	11	1x DP out
5	AT/ATX switch	12	1x HDMI out
6	1x 9-pin D-sub / Via cable(option) for RS232	13	1x Line out
7	2x USB2.0	14	1x VGA



NOTE: DP/HDMI/VGA only support one for second display

1.5 Packing List

A complete bundled package should contain the following items:

- GOT315W-521-PCT unit x 1
- Driver CD x1
- Phoenix connector (DC power version only)
- Panel mount kit

Please contact an Axiomtek distributor immediately if any of the above-mentioned items is missing.

This page is intentionally left blank.

Section 2

Hardware and Installation

The GOT315W-521-PCT provides rich I/O ports and flexible expansion for users to meet different demands. This Section describes hardware installation, including the following subsections:

- Board Layout
- Jumper and Connector Setting
- Mounting Methods
- Hardware Installation
- Power Input

2.1 Board Layout

Please follow the steps below to open the GOT315W-521-PCT unit.

Step 1 Unscrew 4 screws (see red circles in Figure 2-1) on the back cover.

Figure 2-1 Back cover

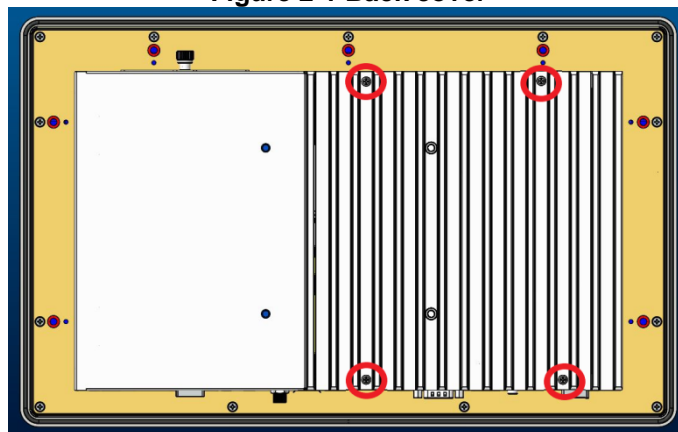

Step 2 Remove the back cover.

Figure 2-2 Board layout

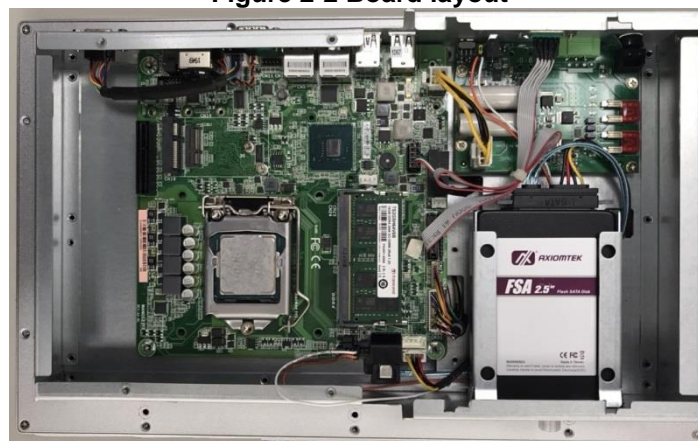

2.2 Jumper and Connector Settings

Jumper is a small component consisting of jumper clip and jumper pins. Install jumper clip on 2 jumper pins to close the pins. And remove jumper clip from 2 jumper pins to open the pins. Diagram 2-1 illustrates how to set up a jumper.

Diagram 2-1 Definitions of pin settings

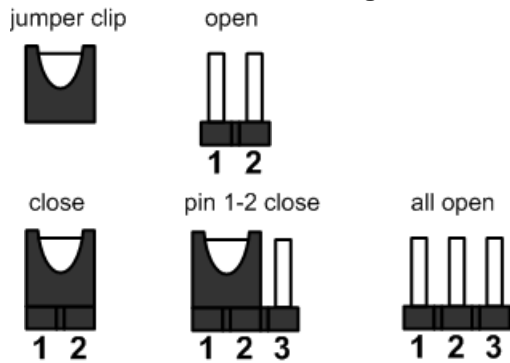

Before applying power to GOT315W-521-PCT, please make sure all of the jumpers and connectors are in default position as listed in Table 2-1.

 **NOTE:** Once the default jumper setting needs to be changed, please do it under power-off condition.

Table 2-1 Factory mode of jumper settings

Jumper	Descriptions	Setting
JP4	Restore BIOS Optional Defaults(Clear CMOS) Default: Normal Operation	1-2 Close
JP6	AT/ATX Power Mode Select Default: ATX Mode	1-2 Close

2.2.1 Restore BIOS Optimal Defaults Jumper (JP4)

This jumper allows you to clear the Real Time Clock (RTC) RAM in CMOS. You can clear the CMOS memory of date, time, and system setup parameters by erasing the CMOS RTC RAM data. The onboard button cell battery powers the RAM data in CMOS, which includes system setup information such as system passwords.

To erase the RTC RAM:

1. Turn OFF the computer and unplug the power cord.
2. Remove the onboard battery.
3. Move the jumper clip from pins 1-2 (default) to pins 2-3. Keep the clip on pins 2-3 for about 5~10 seconds, then move the clip back to pins 1-2.
4. Re-install the battery.
5. Plug the power cord and turn ON the computer.
6. Hold down the key during the boot process and enter BIOS setup to re-enter data.

Function	Setting
Normal operation (Default)	1-2 close
Restore BIOS optimal defaults	2-3 close



2.2.2 Auto Power On Jumper (JP6)

If JP6 is enabled for power input, the system will be automatically power on without pressing soft power button. If JP7 is disabled for power input, it is necessary to manually press soft power button to power on the system

Function	Setting
Enable auto power on "ATX mode" (Default)	1-2 close
Disable auto power on "AT mode"	2-3 close

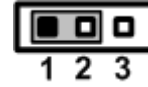

NOTE: Either AT/ATX switch or JP7, just only one setting is "AT" that will be operated by AT power.

2.2.3 COM Port Connector

This connector is a standard D-Sub connector for COM1 serial port interface which is selectable for RS-232/422/485 mode by BIOS setting (see section 4.4). The pin assignments of RS-232/422/485 are listed in table below.

Table 2-4 Pin assignment for RS-232/ 422/ 485

Pin	RS-232	RS-422	RS-485
1	DCD	TX-	Data-
2	RXD	TX+	Data+
3	TXD	RX+	N/C
4	DTR	RX-	N/C
5	GND	GND	GND
6	DSR	N/C	N/C
7	RTS	N/C	N/C
8	CTS	N/C	N/C
9	RI	N/C	N/C

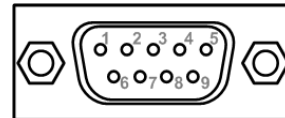

2.3 Ethernet Connector

There are two RJ-45 connectors, LAN1 and LAN2, inside the GOT315W-521-PCT. Ethernet connection can be established by plugging one end of the Ethernet cable into this RJ-45 connector and the other end (phone jack) to a 1000/100/10-Base-T hub.

Please refer to Table 2-5 for detailed pin assignment for LAN1 and LAN2.

Table 2-5 Pin assignment for LAN1/ LAN2

Pin	1000 Base-T	100/10 Base-T	Description
L1	BI_DA+	TX+	Bidirectional or Transmit Data+
L2	BI_DA-	TX-	Bidirectional or Transmit Data-
L3	BI_DB+	RX+	Bidirectional or Receive Data+
L4	BI_DC+	N.C.	Bidirectional or Not Connected
L5	BI_DC-	N.C.	Bidirectional or Not Connected
L6	BI_DB-	RX-	Bidirectional or Receive Data-
L7	BI_DD+	N.C.	Bidirectional or Not Connected
L8	BI_DD-	N.C.	Bidirectional or Not Connected
A	Active Link LED (Yellow) Off: No link Blinking: Data activity detected		
B	Speed LED 1000: Orange 100/10: Green/OFF		

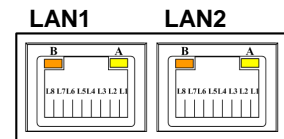

LAN1 with Intel® i211AT

LAN2 with Intel® i219V

2.4 Mounting Methods

There are four ways to install the GOT315W-521-PCT, namely: panel/ VESA/ wall/ desktop mount.

The GOT315W-521-PCT provides a standard panel mount kit. It can be installed by way of panel mount (see Figure 2-1, 2-2).

Figure 2-1 Panel mount (back chassis)

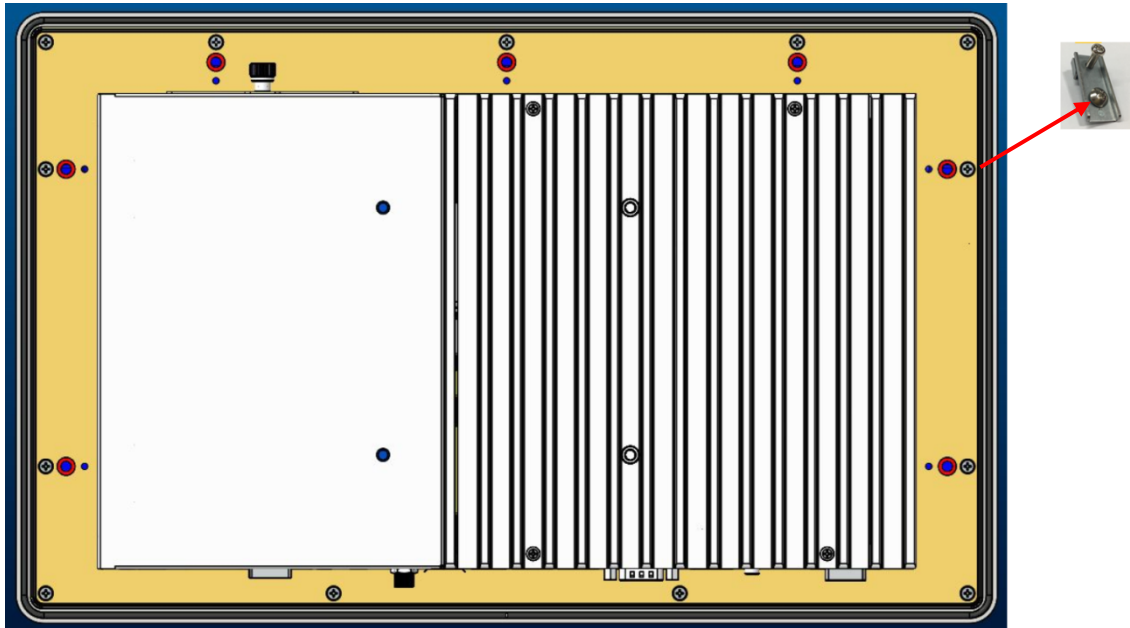
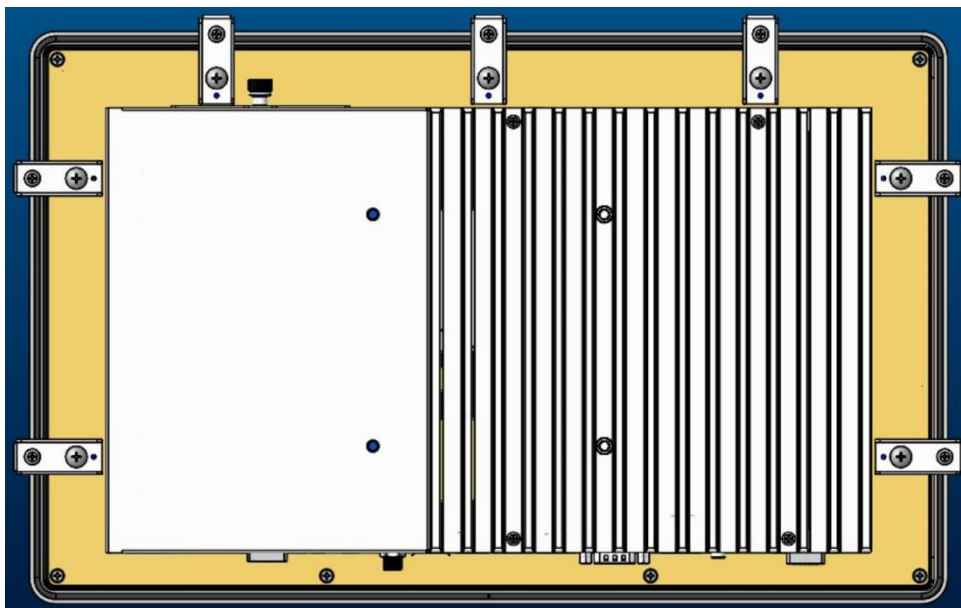

Figure 2-2 Panel mount kit



Alternatively, the GOT315W-521-PCT can be installed by way of VESA mount which is in the dimensions of 100x100 mm. Simply fix four screws to fasten the kit from the back chassis, as shown in Diagram 2-3. Additionally, users can otherwise go for wall mount as an option, as shown in Diagram 2-4.

Diagram 2-3 VESA mount (back chassis)

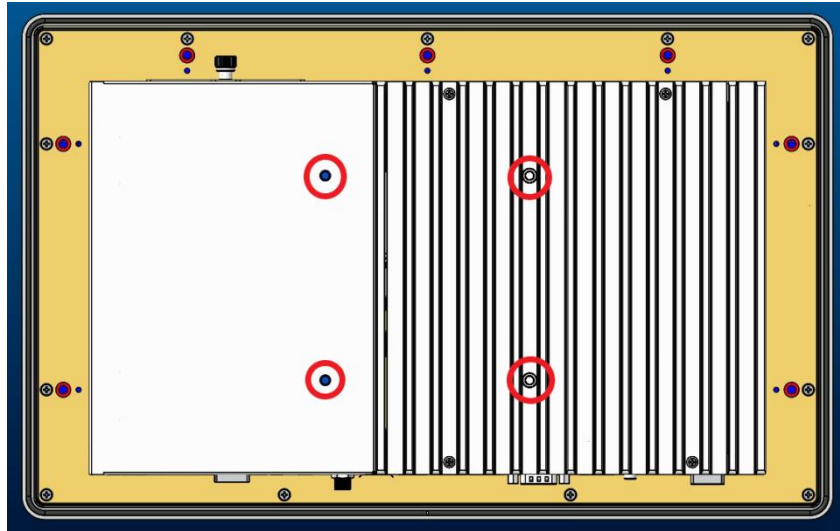
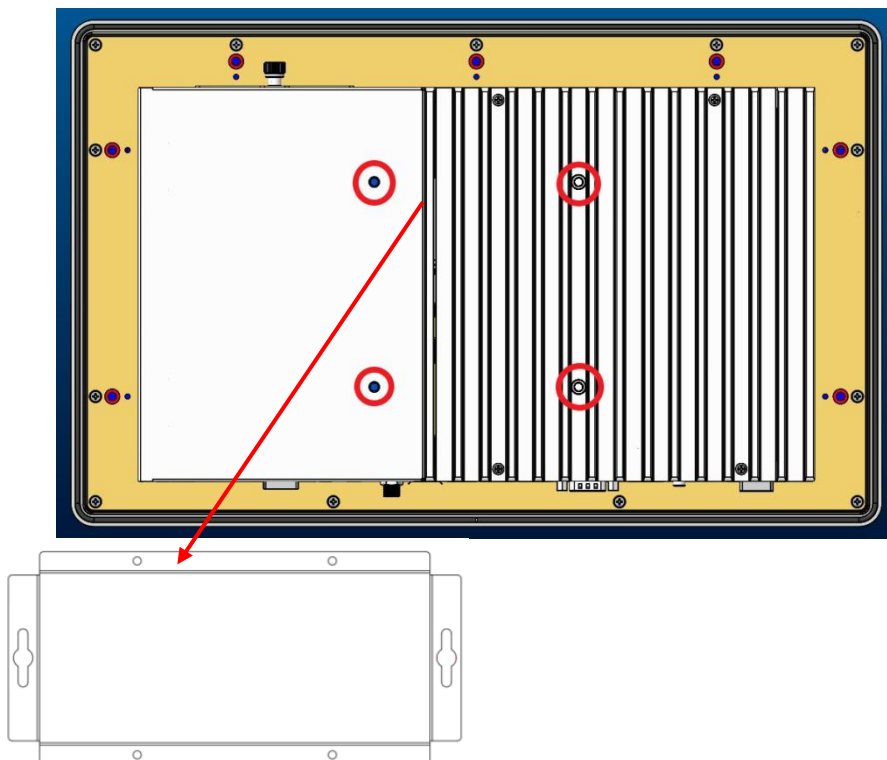

Diagram 2-4 Wall mount (back chassis)



2.5 Hardware Installation

2.5.1 Installing a HDD

The GOT315W-521-PCT provides a convenient swappable Hard Disk Driver (HDD) bracket for users to install a 2.5"(support 7mm & 9.5mm) wide temperature SATA HDD. Please follow the steps:

- Step 1** Refer to Section 2.1 to open the back cover
Step 2 Unfastening the screw to slide open. (as shown in Figure 2-5)

Figure 2-5 Open the HDD tray

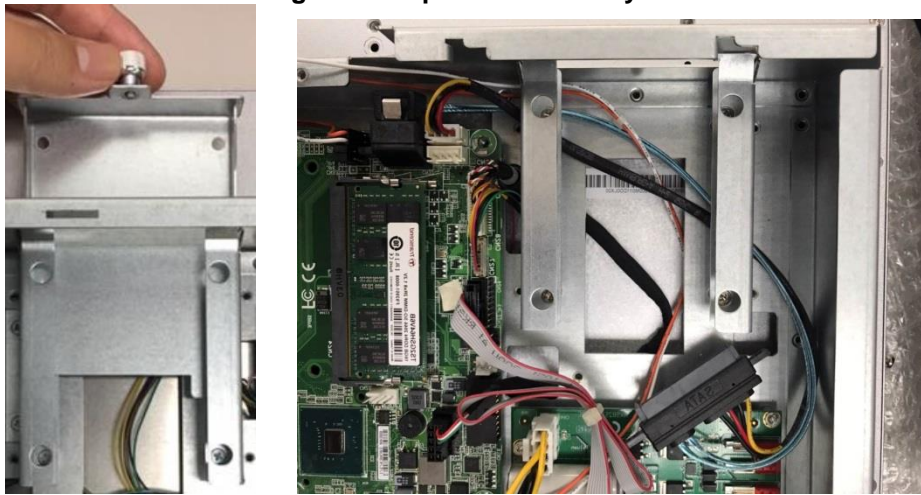

- Step 3** Take 2.5" HDD on the bracket and fasten the four screws in the other side. And plug the "SATA + Power" connector to complete the installation. Completing installation by fastening the screw.

Figure 2-6 Fastening a HDD to the bracket and completing the installation



2.5.2 Installing a DRAM

The GOT315W-521-PCT provides one 260-pin DDR4 2133/2440Mhz SO-DIMM socket that supports system memory up to 32GB. Please follow steps below to install a memory module:

- Step 1** Refer to Section 2.1 to open the back cover.
- Step 2** Locate the DIMM socket (as shown in Figure 2-9) on mainboard .
- Step 3** Insert a RAM into the DIMM socket, and then push it down firmly until it is clipped with the socket

Figure 2-9 DIMM spot

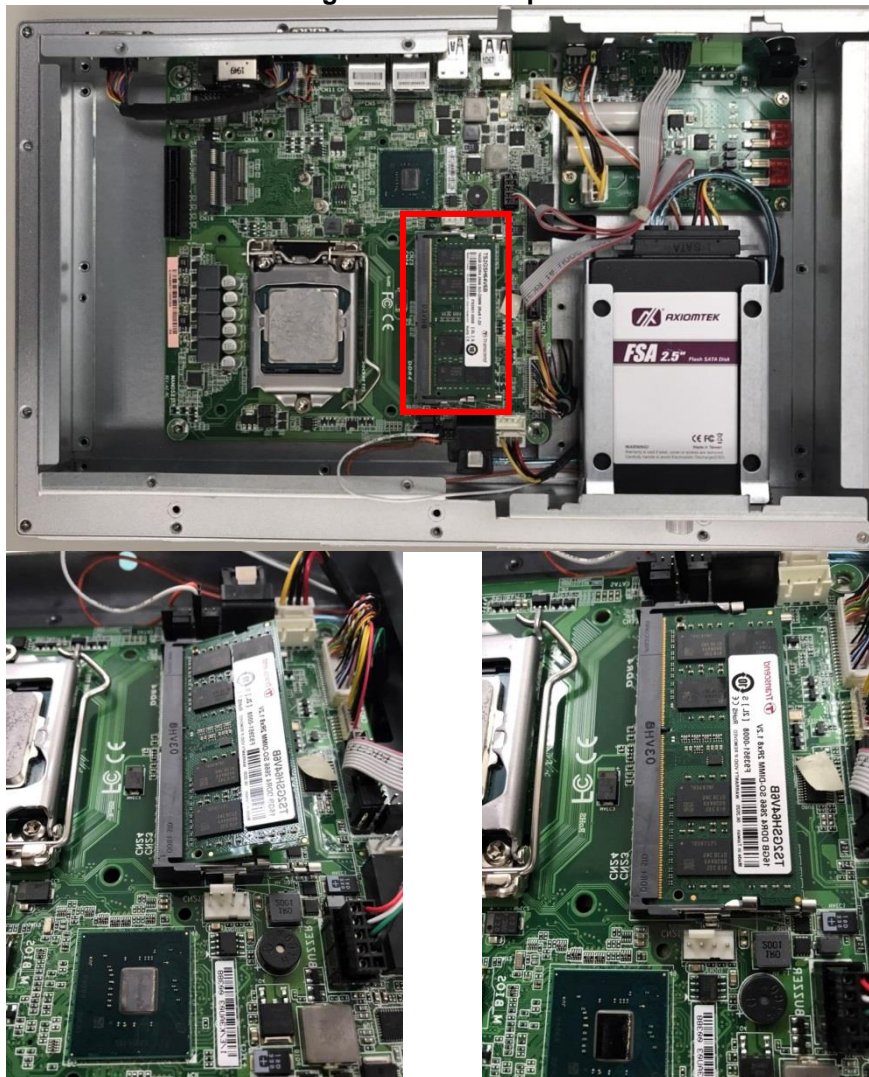

2.5.3 Installing a CPU

The CPU socket type on main board that support 8th Gen Intel® Core™ processor up to 35W
Coffee Lake-S i5-8500T Tj 100°C
Coffee Lake-S G5400T Tj 100/88°C

- Step 1 Move the iron bar
- Step 2 Open the cover
- Step 3 Put CPU in the socket
- Step 4 Re-chuck the iron bar

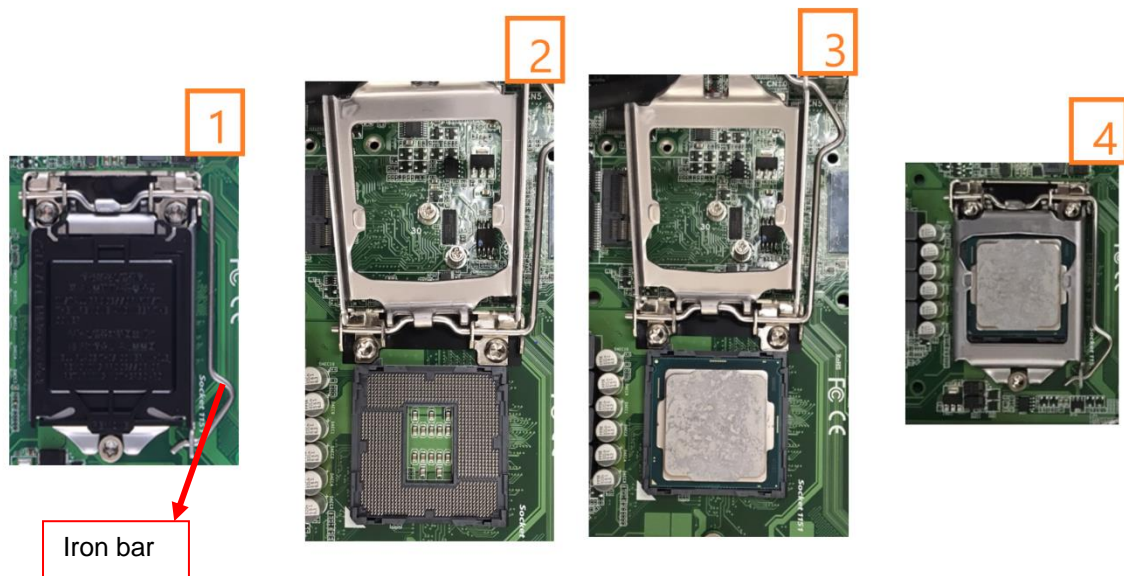

NOTE: If user took off the CPU protective cover, please put it back protect the socket pin when the system need to RMA shipping.

Section 3

AMI BIOS Setup Utility

This Section provides users with detailed descriptions about how to set up basic system configurations through the AMI BIOS setup utility.

3.1 Navigation Keys

The BIOS setup/utility uses a key-based navigation system called hot keys. Most of the BIOS setup utility hot keys can be used at any time during the setup navigation process. These keys include <F1>, <F2>, <Enter>, <ESC>, <Arrow> keys, and so on.



NOTE: Some of navigation keys may differ from one screen to another.

Table 3-1 Descriptions of hot keys

Hot Keys	Description
→← Left/Right	The Left and Right <Arrow> keys allow you to select a setup screen.
↑↓ Up/Down	The Up and Down <Arrow> keys allow you to select a setup screen or sub screen.
Enter	The <Enter> key allows you to display or change the setup option listed for a particular setup item. The <Enter> key can also allow you to display the setup sub screens.
+– Plus/Minus	The Plus and Minus <Arrow> keys allow you to change the field value of a particular setup item.
F1	The <F1> key allows you to display the General Help screen.
F2	The <F2> key allows you to Load Previous Values.
F3	The <F3> key allows you to Load Optimized Defaults.
F4	The <F4> key allows you to save any changes you have made and exit Setup. Press the <F4> key to save your changes.
Esc	The <Esc> key allows you to discard any changes you have made and exit the Setup. Press the <Esc> key to exit the setup without saving your changes.

3.2 Main Menu

When you first enter the setup utility, you will enter the Main setup screen. You can always return to the Main setup screen by selecting the Main tab. System Time/Date can be set up as described below. The Main BIOS setup screen is shown below

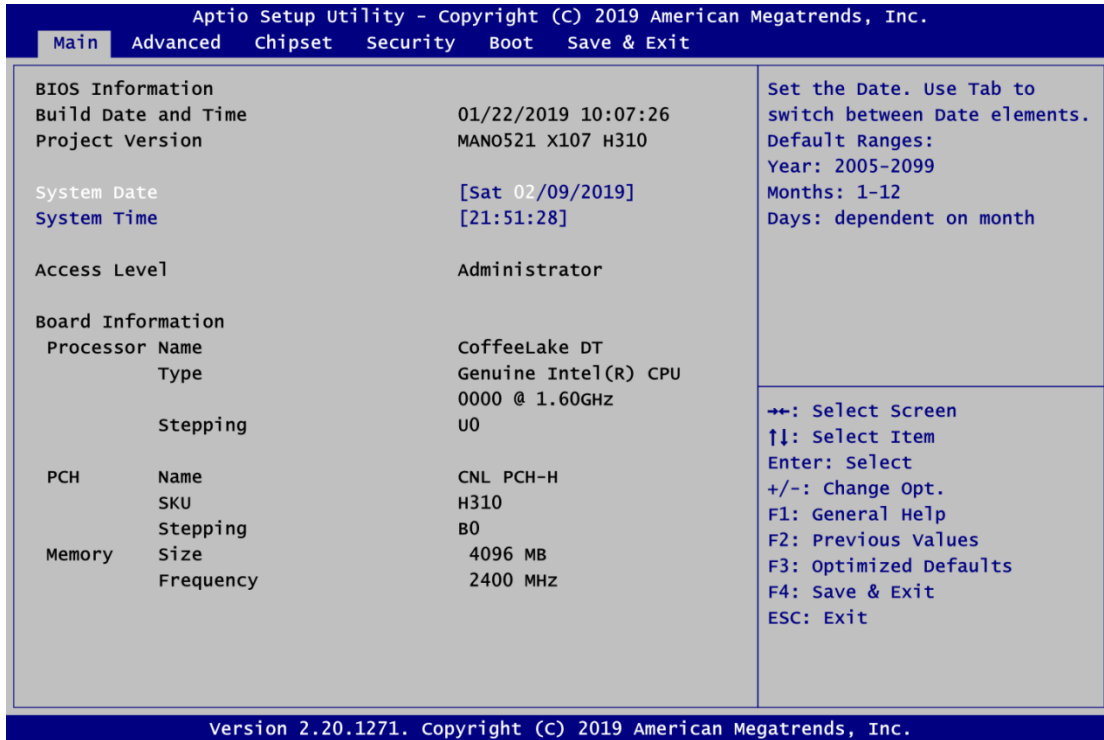

BIOS Information

Display the BIOS information.

System Date/Time

Use this option to change the system time and date. Highlight System Time or System Date using the <Arrow> keys. Enter new values through the keyboard. Press the <Tab> key or the <Arrow> keys to move between fields. The date must be entered in MM/DD/YY format. The time is entered in HH:MM:SS format.

Access Level

Display the access level of current user.

Board Information

Display the board information.

3.3 Advanced Menu

The Advanced menu also allows users to set configuration of the CPU and other system devices. You can select any of the items in the left frame of the screen to go to the sub menus

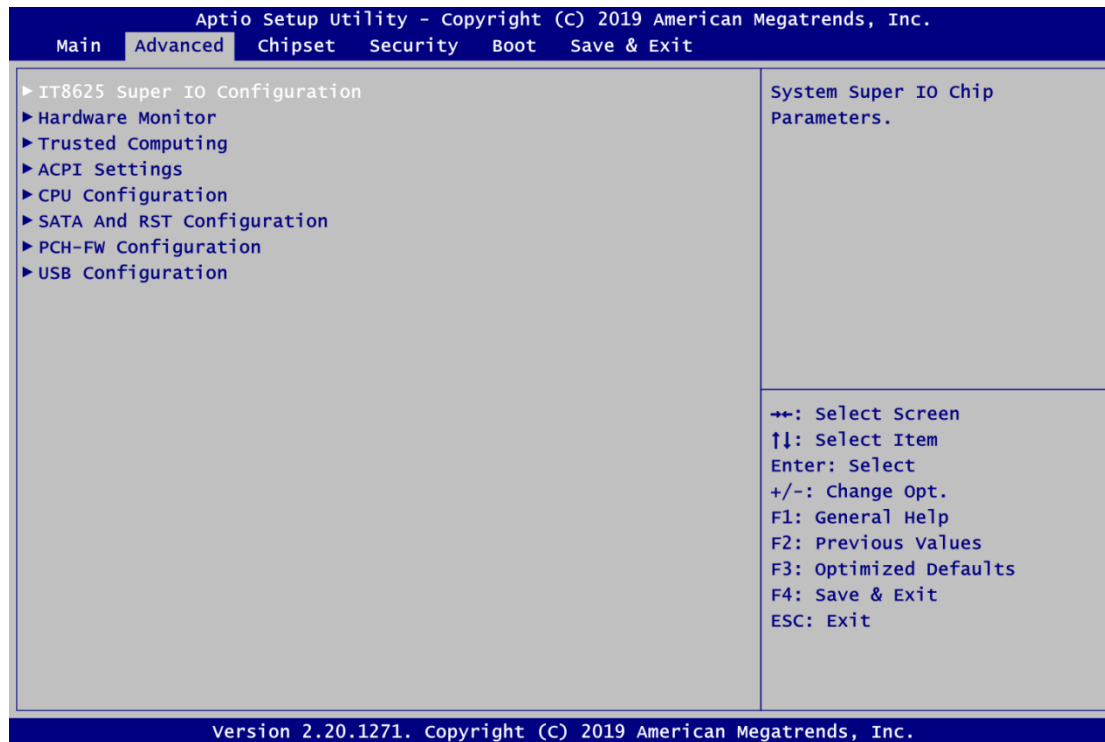

- ▶ IT8625 Super IO Configuration
- ▶ Hardware Monitor
- ▶ Trusted Computing
- ▶ ACPI Settings
- ▶ CPU Configuration
- ▶ SATA And RST Configuration
- ▶ PCH-FW Configuration
- ▶ USB Configuration

For items marked with “▶”, please press <Enter> for more options.

3.3.1 IT8625 Super IO Configuration

You can use this screen to select options for the Super IO Configuration, and change the value of the selected option. A description of the selected item appears on the right side of the screen. For items marked with "▶", please press <Enter> for more options.

Serial Port 1~2 Configuration

This option is used to enable or disable serial port 1~2

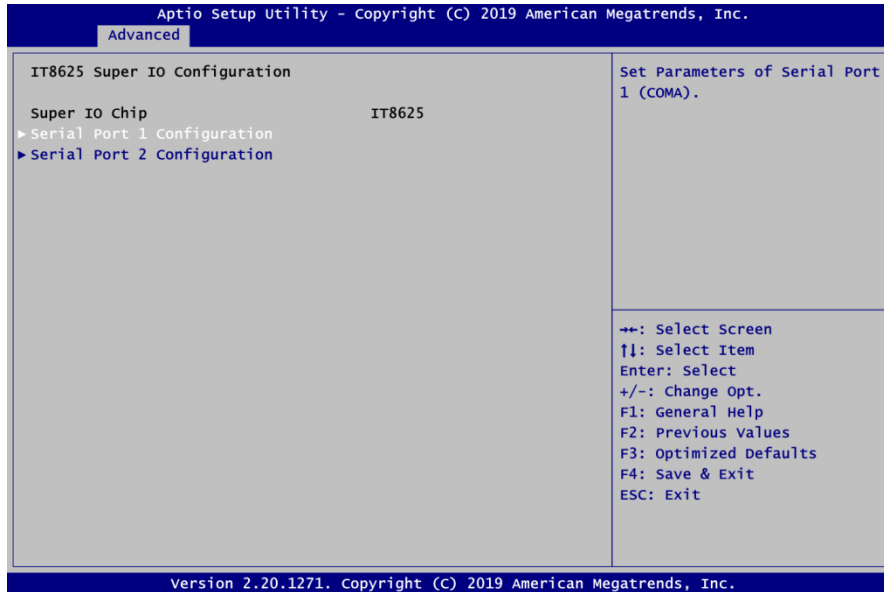

- **Serial Port 1 Configuration**

Serial Port

Enable or disable serial port 1. The optimal setting for base I/O address is 3F8h and for interrupt request address is IRQ4.

COM Port Type

Use this item to set RS-232/422/485 communication mode

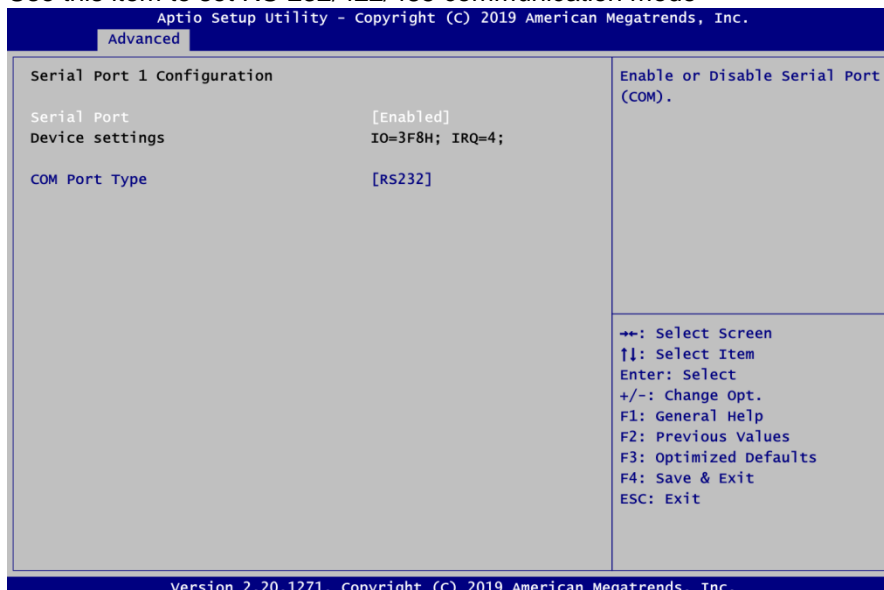

- **Serial Port 2 Configuration**

Serial Port

Enable or disable serial port 2. The optimal setting for base I/O address is 2F8h and for interrupt request address is IRQ3

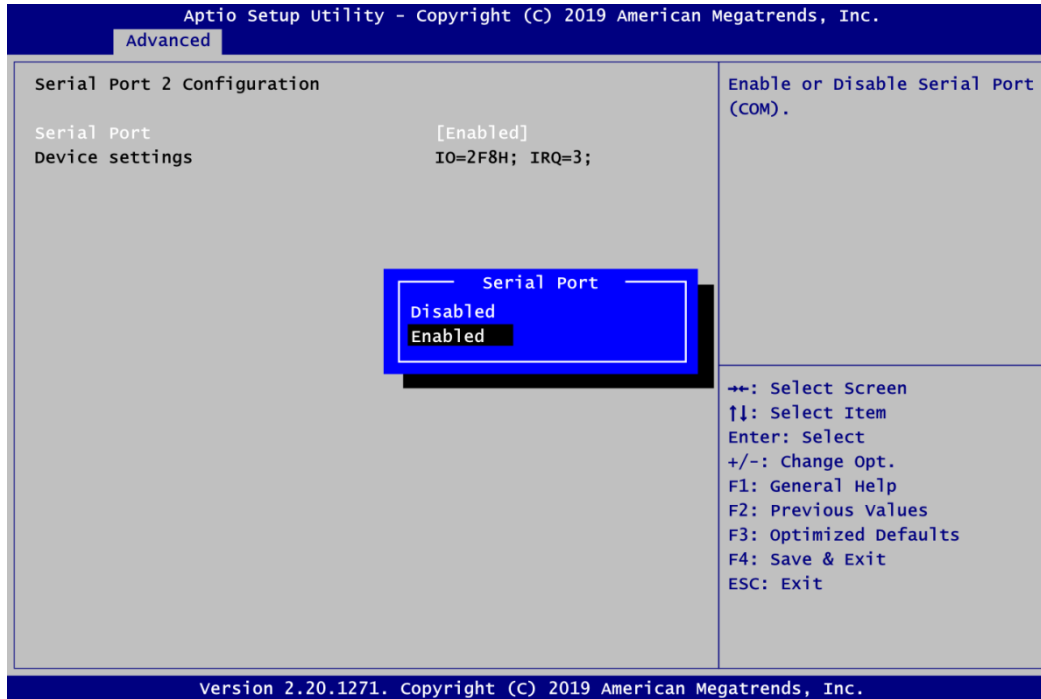

3.3.2 Hardware Monitor

Below shows a screen reflecting the health status of the hardware in real time. This screen displays the temperature of system and CPU, cooling fans speed in RPM and system voltages (VCC_CPU, +3.3V, +12V, +5V, +5V standby, +3.3V standby and VBAT).

Case Open

Switch on or off case open

The screenshot shows the 'Advanced' tab of the Aptio Setup Utility. The 'PC Health Status' section lists various system metrics. The 'Case Open' setting is currently set to '[Enabled]'. A legend on the right side of the screen provides navigation instructions for the BIOS menu.

PC Health Status		Switch On/off case open
System temperature	: +24 °C	
PCH temperature	: +31 °C	
CPU temperature	: +43 °C	
CPU Fan Speed	: N/A	
System Fan Speed	: N/A	
VCC_CPU	: +1.465 V	
+3.3V	: +3.394 V	
+12V	: +12.408 V	
+5V	: +5.087 V	
+5V_SBY	: +5.087 V	
+3.3V_SBY	: +3.448 V	
VBAT	: +3.036 V	
Case Open	[Enabled]	
▶ Smart Fan Function		

Legend:

- : Select Screen
- ↑↓: Select Item
- Enter: Select
- +/-: Change Opt.
- F1: General Help
- F2: Previous Values
- F3: Optimized Defaults
- F4: Save & Exit
- ESC: Exit

Version 2.20.1271. Copyright (C) 2019 American Megatrends, Inc.



NOTE: For Intel® Q370 SKU, the case open default setting in BIOS menu is close.

3.3.3 Trusted Computing

This screen provides function for specifying the TPM settings.

Security Device Support

Enable or disable BIOS support for security device. OS will not show security device. TCG EFI protocol and INT1A interface will not be available.

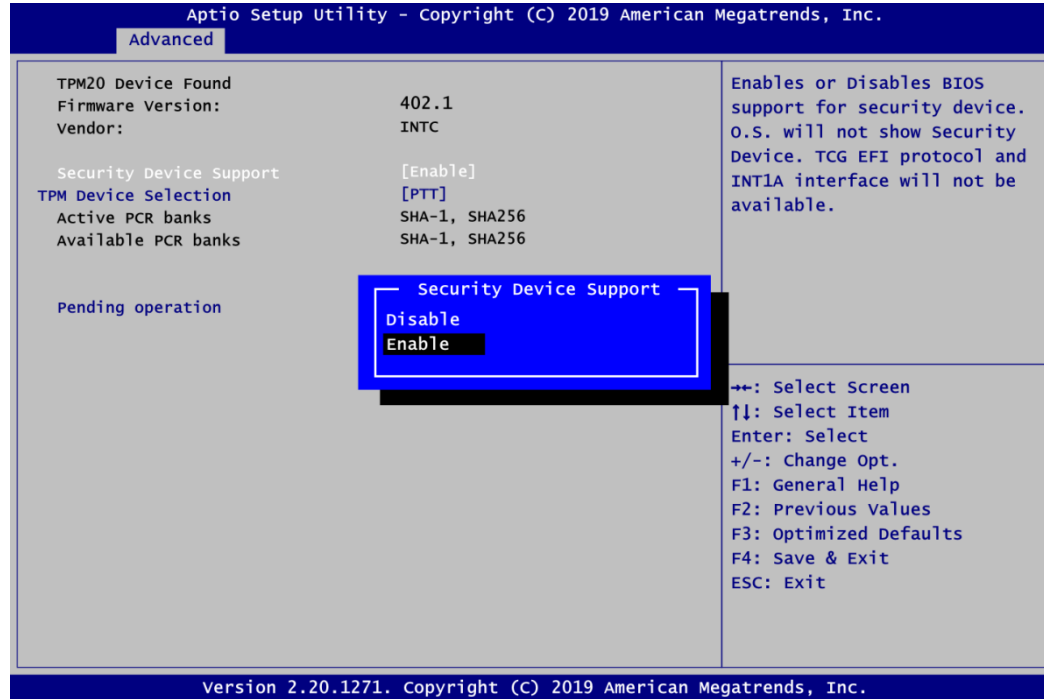

TPM Device Selection

Select TPM device:

- dTPM: External extended Infineon's TPM



- PTT: Intel® built-in TPM.

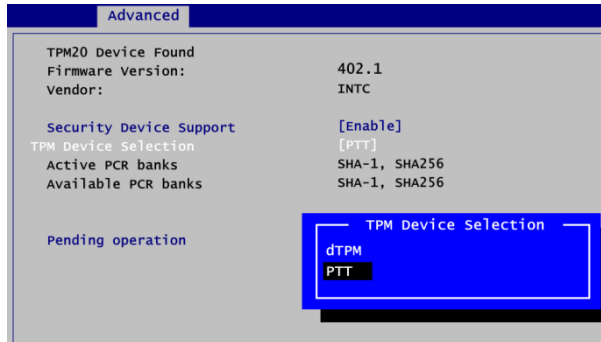

Pending operation

Schedule an operation for the security device, see image below.

- None
- TPM Clear: Clear all data secured by TPM.

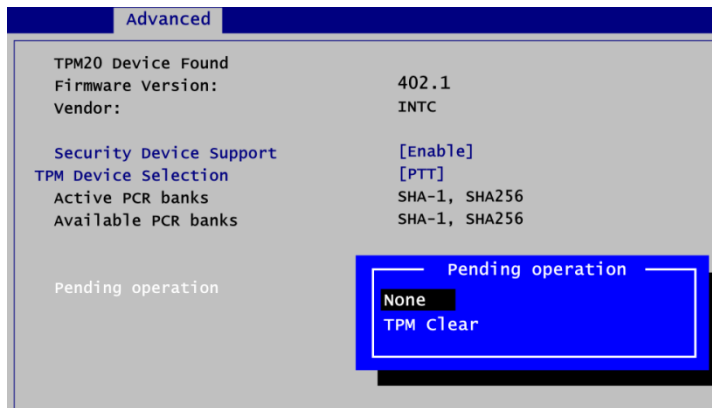

3.3.4 ACPI Setting

ACPI Sleep State

When the suspend button is pressed, the ACPI (Advanced Configuration and Power Interface) sleep state is S3 (Suspend to RAM).

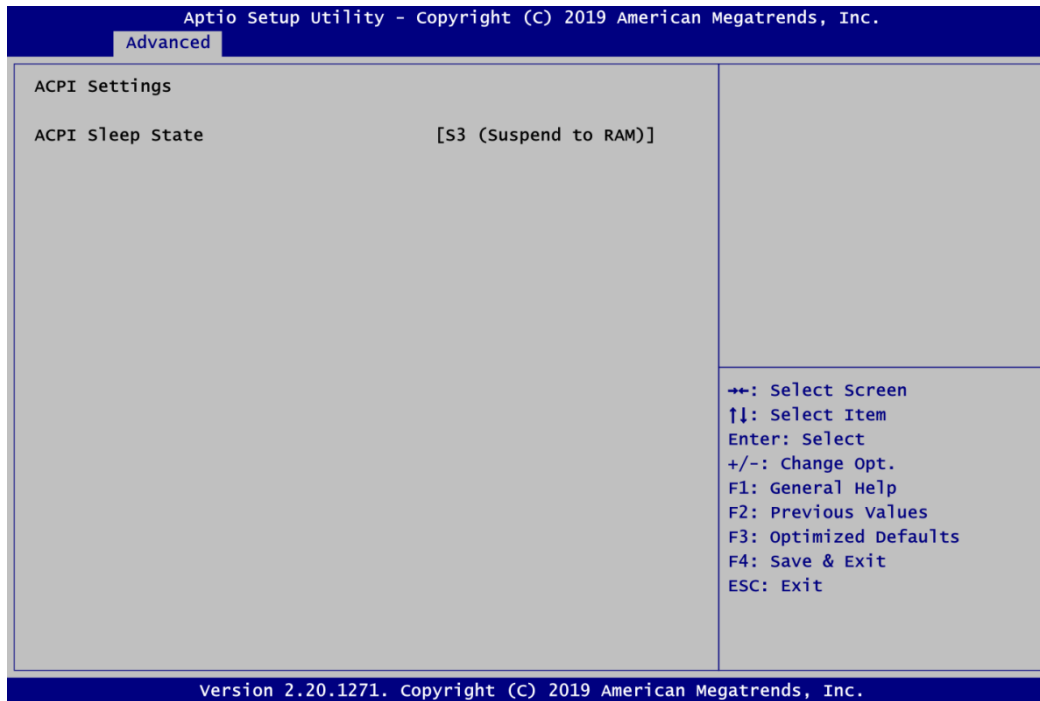

3.3.5 CPU Configuration

Intel (VMX) Virtualization Technology

Enable or disable Intel Virtualization Technology. When enabled, a VMM (Virtual Machine Mode) can utilize the additional hardware capabilities. It allows a platform to run multiple operating systems and applications independently, hence enabling a single computer system to work as several virtual systems.

Below shows a page of CPU configuration with item *Intel Virtualization Technology [enable/disable]* highlighted.

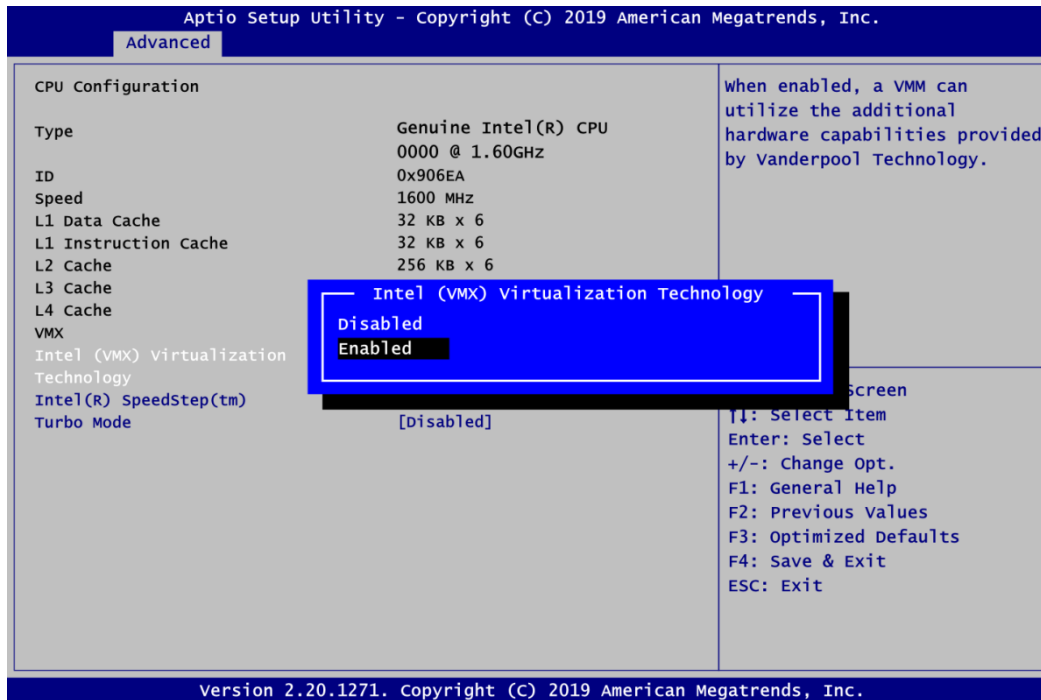

Intel(R) SpeedStep(tm)

Enable or disable Intel® SpeedStep. It allows more than two frequency ranges to be supported.

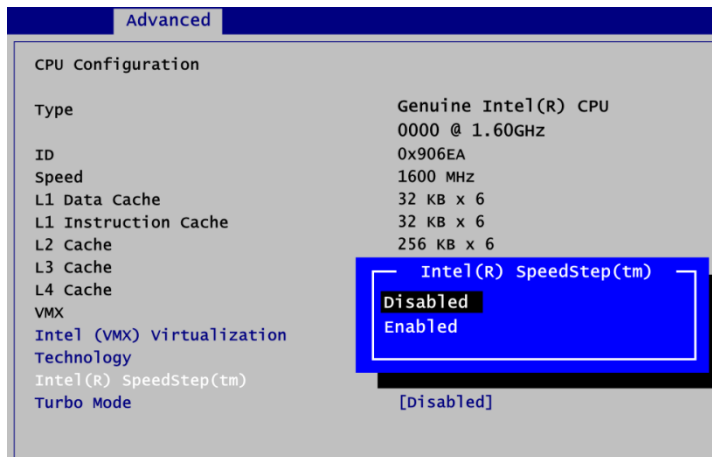

3.3.6 SATA Configuration

This screen allows users to select options for SATA Configuration, and change the value of the selected option.

SATA Controller

Highlight this item to set up SATA Controller to be Enable or Disable.

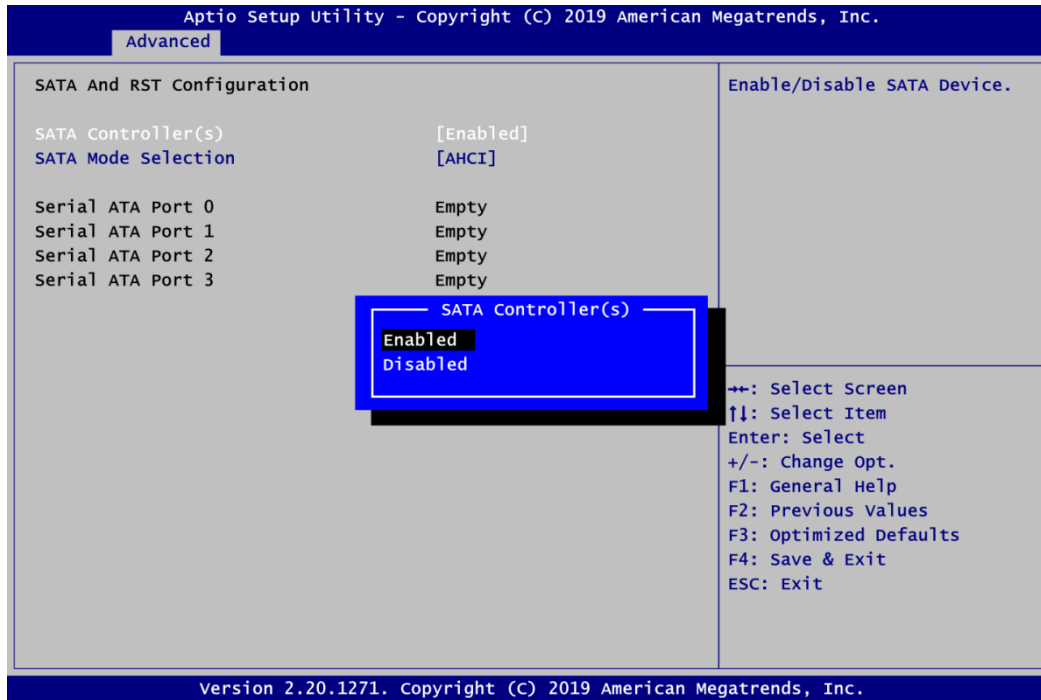

SATA Mode Selection

Determine how SATA controller(s) operate.

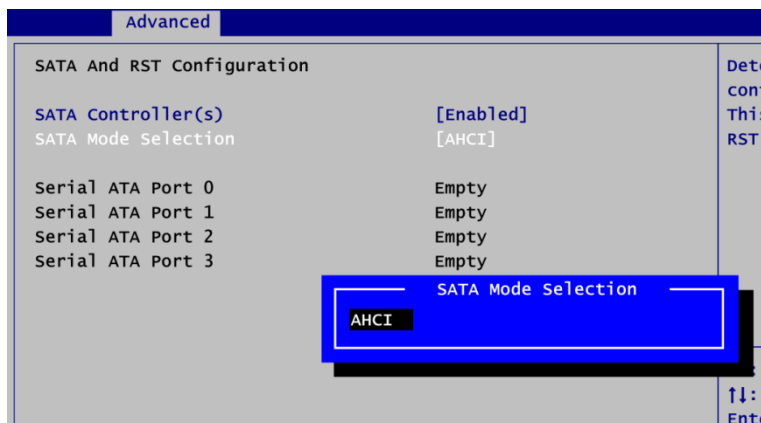

3.3.7 PCH-FW Configuration

This screen displays ME Firmware information.

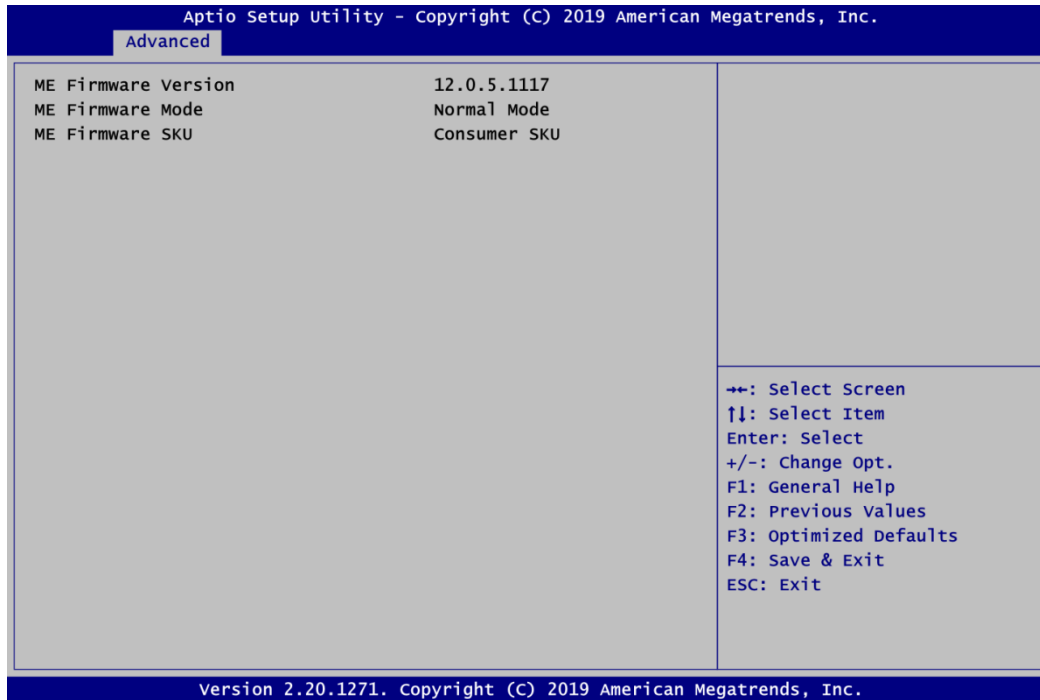

3.3.8 USB Configuration

Display all detected USB devices.

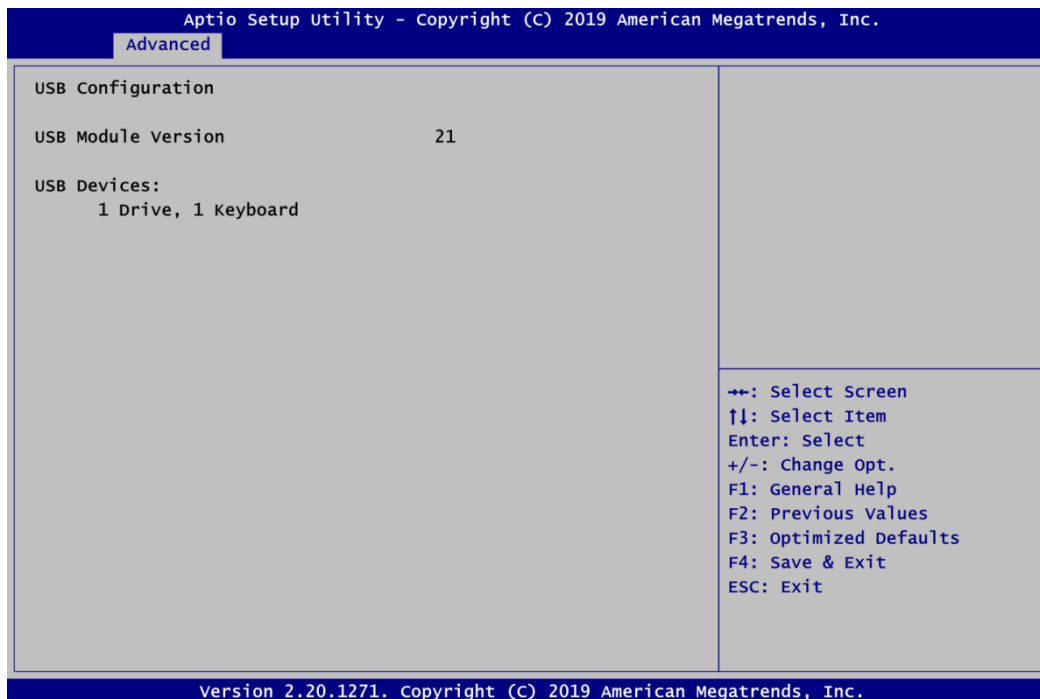

3.4 Chipset Menu

The Chipset menu allows users to change the advanced chipset settings. You can select any of the items in the left frame of the screen to go to the sub menus:

- ▶ System Agent (SA) Configuration
- ▶ PCH-IO Configuration

For items marked with “▶”, please press <Enter> for more options.

3.4.1 System Agent (SA) Configuration

This screen allows users to configure System Agent (SA) parameters. For items marked with “▶”, please press <Enter> for more options.

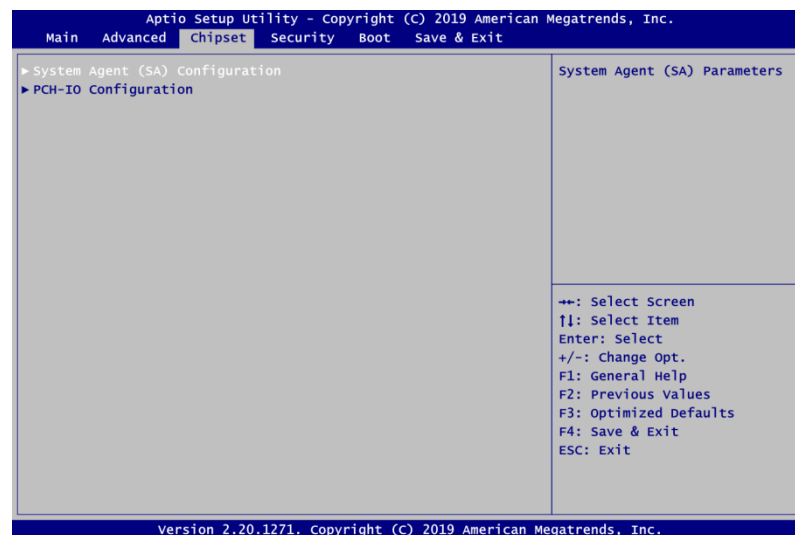

Graphics Configuration

Select to open sub menu for parameters related to graphics configuration.

Memory Configuration

Select to open sub menu for information related to system memory.

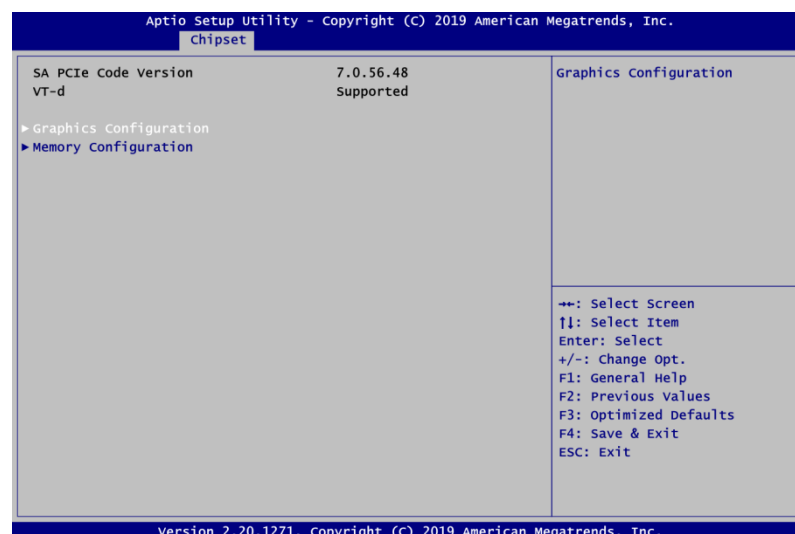

Graphics Configuration

Primary IGFX Boot Display

Select the video device which will be activated during POST (Power-On Self Test). The secondary boot display selection will appear based on your selection.

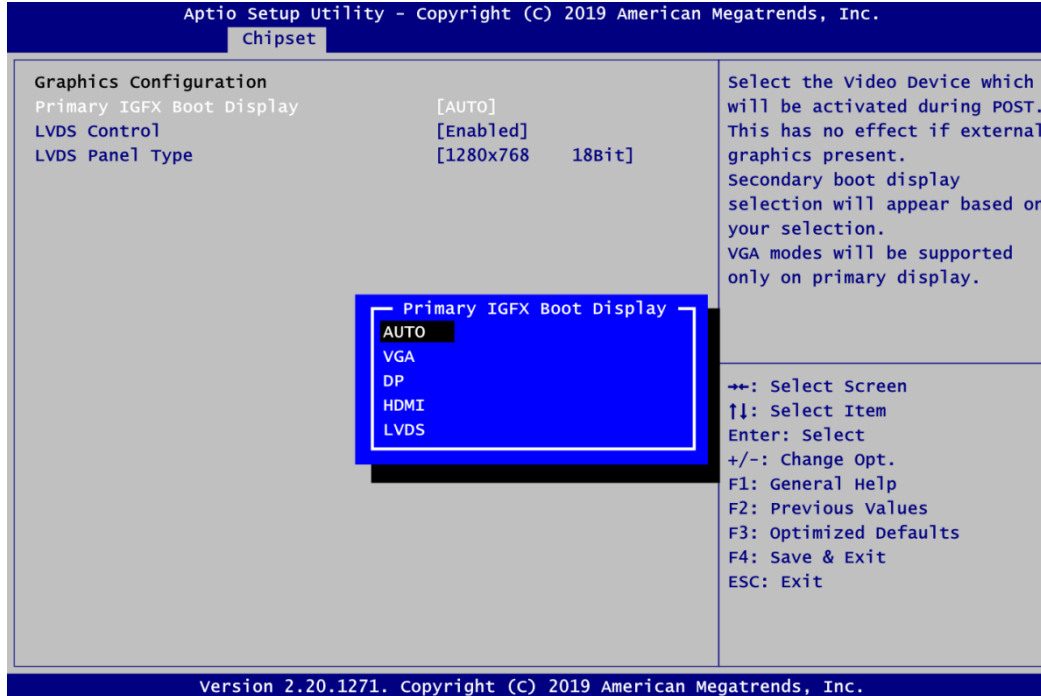

Secondary IGFX Boot Display

After selecting other than "AUTO" on "Primary IGFX Boot Display", the Secondary IGFX Boot Display will show up and its options are DP and HDMI

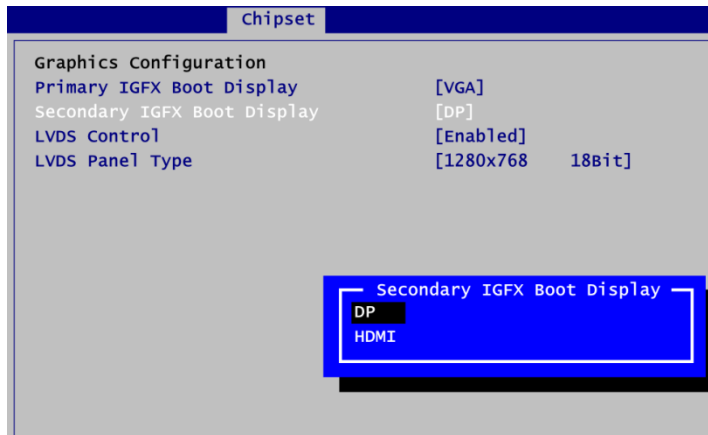

LVDS Control

Enable or disable LVDS Control. When installing Linux OS and if DP, HDMI or VGA display is connected to your system, make sure to set this option to Disabled.

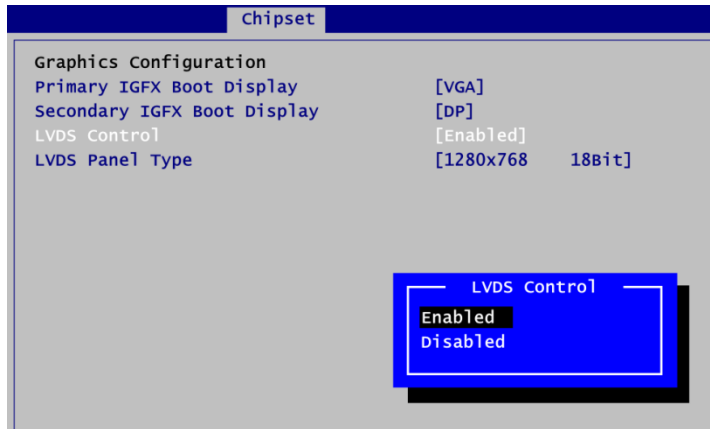
**LVDS Panel Type**

Select the appropriate LVDS panel resolution; see the selection options in image above.

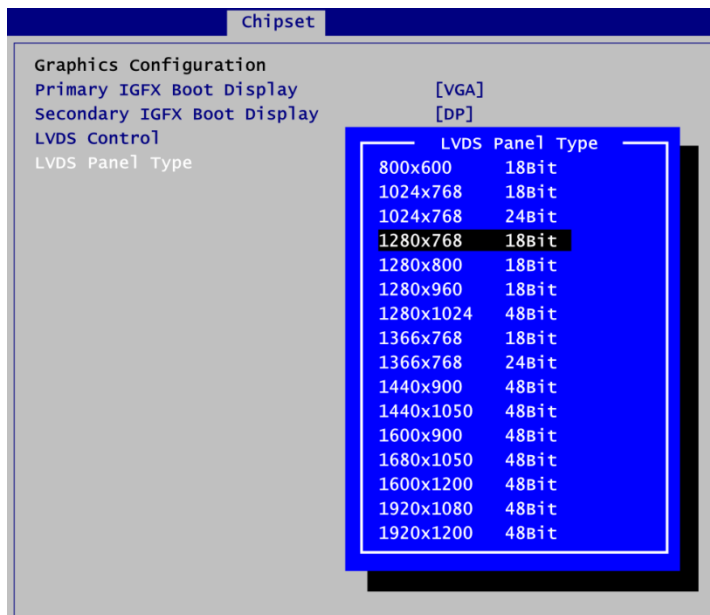
**Brightness Setting**

This option appears only when LVDS panel is connected. It allows user to adjust the brightness level of the LVDS panel.

- Range: 0~255
- Default: 255

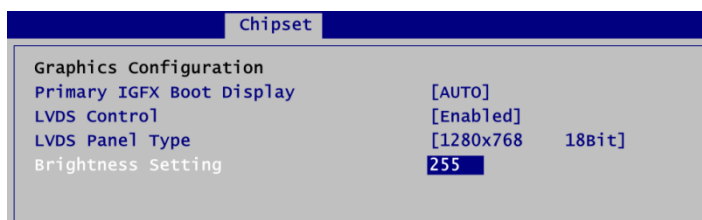

Memory Configuration

This screen shows the system memory information.

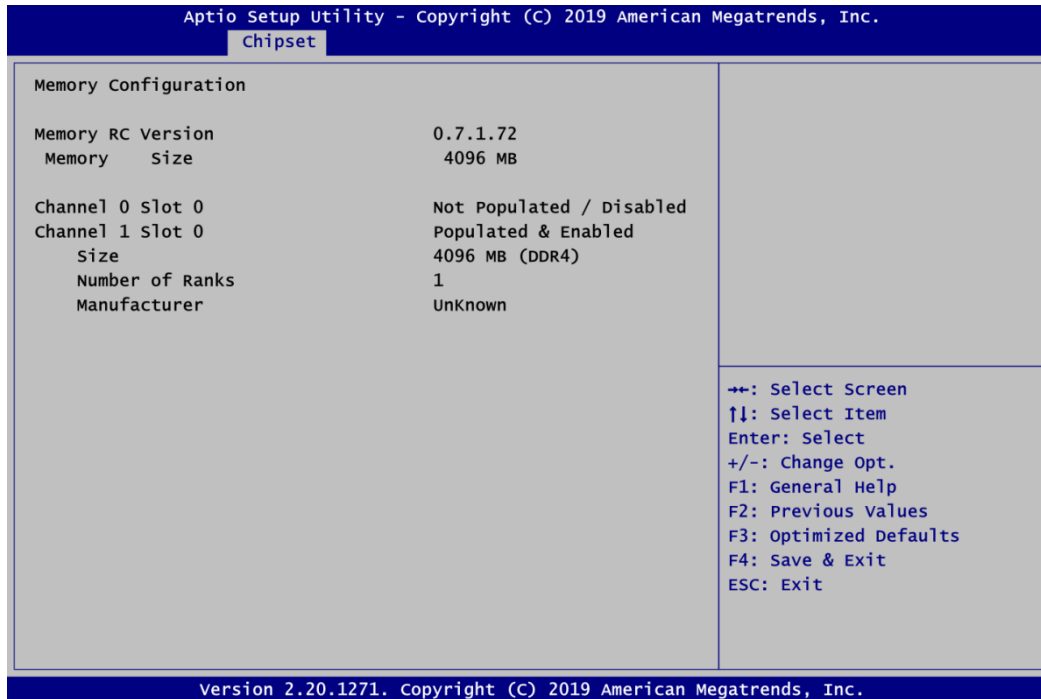

PCH-IO Configuration

This screen allows you to set PCH parameters.

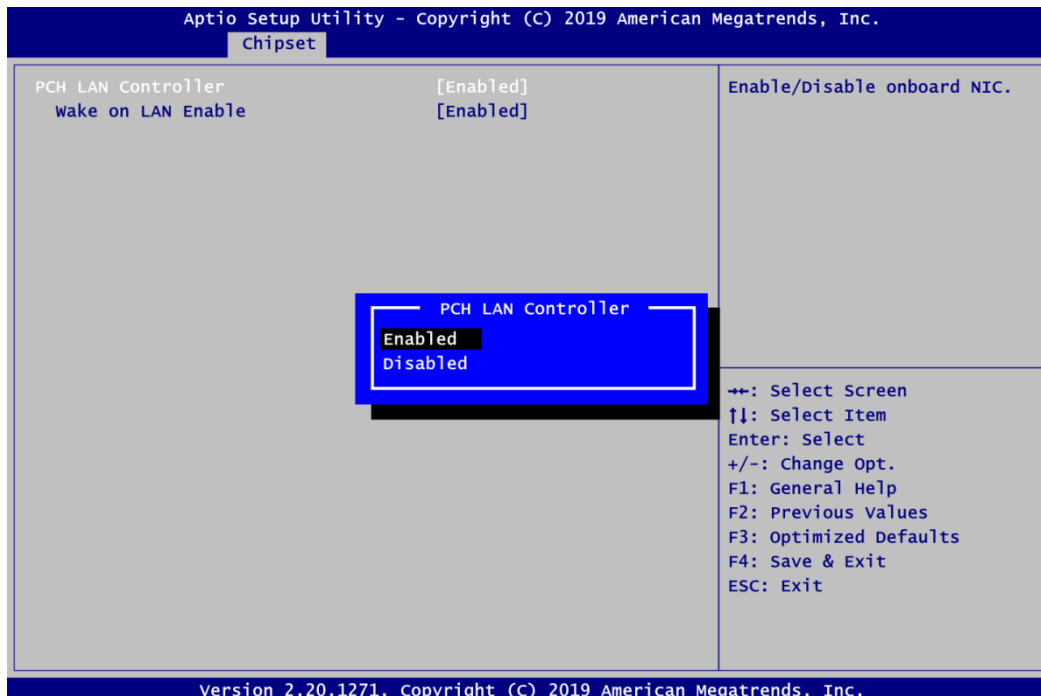

PCH LAN Controller

Enable or disable onboard PCH LAN controller.

Wake on LAN Enable

After enabling PCH LAN Controller, enabling or disabling integrated LAN to wake the system.

3.5 Security Menu

The Security menu allows users to change the security settings for the system.

- **Administrator Password**
Set administrator password.
- **User Password**
Set user password.

Figure 3-15 Security Menu



3.6 Boot Menu

- Setup Prompt Timeout**
 Number of seconds to wait for setup activation key. 65535(0xFFFF) means indefinite waiting.
- Bootup NumLock State**
 Use this item to select the power-on state for the keyboard NumLock.
- Quiet Boot**
 Select to display either POST output messages or a splash screen during boot-up.

The Boot menu allows users to change boot options of the system.

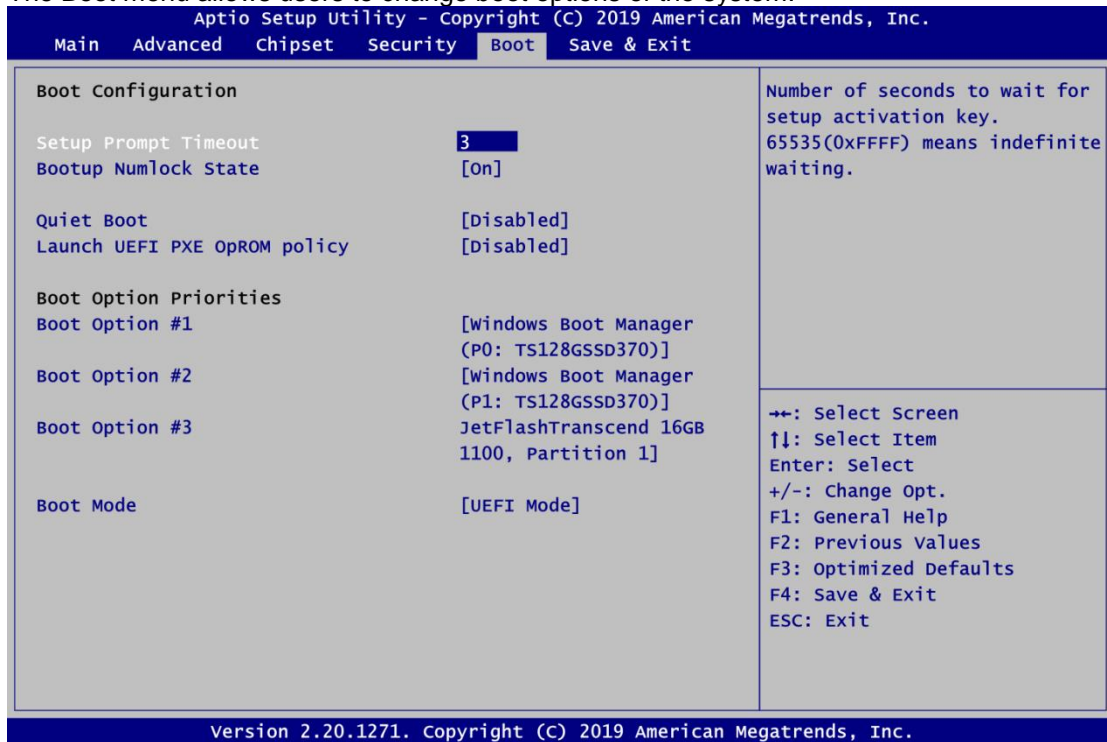

- **Launch UEFI PXE OpROM policy**

Control the execution of UEFI PXE OpROM. When enabled, you may select I219, I211 or Disabled as PXE LAN port.

- **Boot Option Priorities**

These are settings for boot priority. Specify the boot device priority sequence from the available devices.

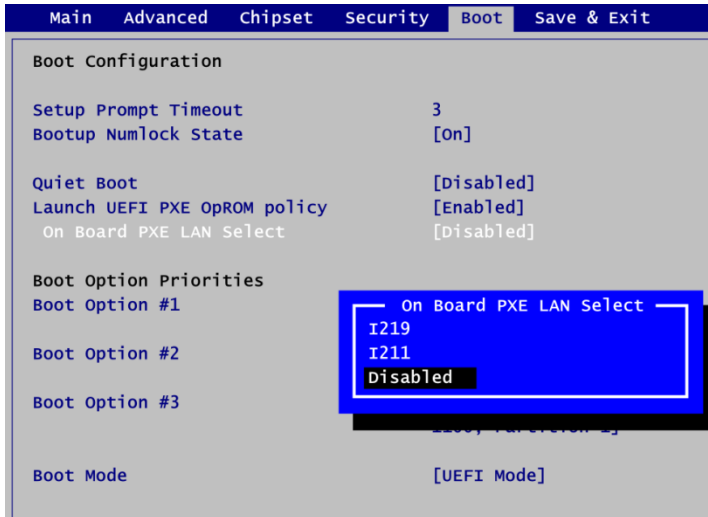

- **Boot Mode**

Use this option for boot mode settings.

- UEFI Boot: Select support to boot any UEFI-capable OS.
- Legacy Boot: Select support to boot non UEFI-capable OS that expects a legacy BIOS interface.

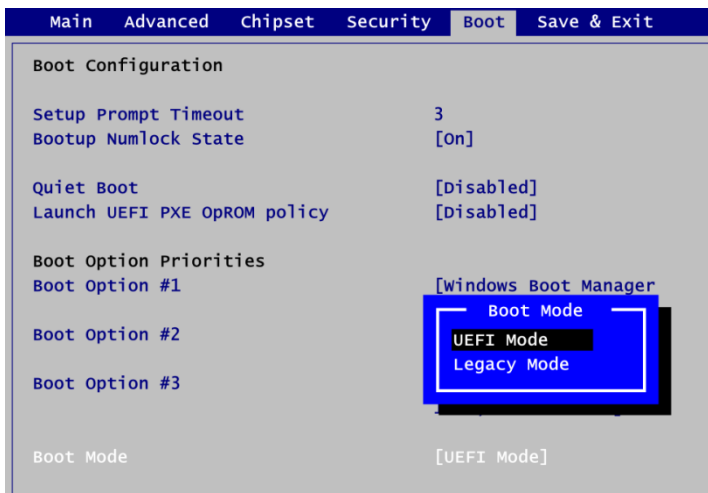

3.7 Save & Exit Menu

The Save & Exit menu allows users to load your system configuration with optimal or fail-safe default values.

Figure 3-17 Save & Exit Menu

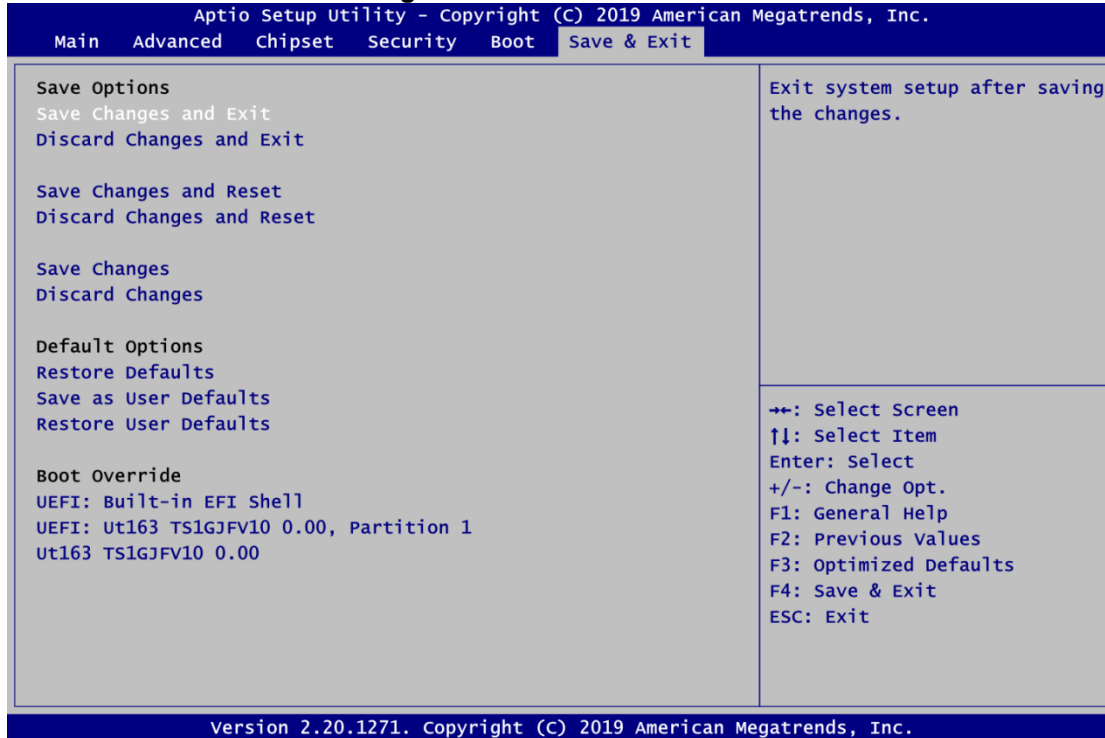

- Save Changes and Exit**
When you have completed the system configuration changes, select this option to leave Setup and return to Main Menu. Select Save Changes and Exit from the Save & Exit menu and press <Enter>. Select Yes to save changes and exit.
- Discard Changes and Exit**
Select this option to quit Setup without making any permanent changes to the system configuration and return to Main Menu. Select Discard Changes and Exit from the Save & Exit menu and press <Enter>. Select Yes to discard changes and exit.
- Save Changes and Reset**
When you have completed the system configuration changes, select this option to leave Setup and reboot the computer so the new system configuration parameters can take effect. Select Save Changes and Reset from the Save & Exit menu and press <Enter>. Select Yes to save changes and reset.
- Discard Changes and Reset**
Select this option to quit Setup without making any permanent changes to the system configuration and reboot the computer. Select Discard Changes and Reset from the Save & Exit menu and press <Enter>. Select Yes to discard changes and reset.
- Save Changes**
When you have completed the system configuration changes, select this option to save changes. Select Save Changes from the Save & Exit menu and press <Enter>. Select Yes to save changes.

- **Discard Changes**
Select this option to quit Setup without making any permanent changes to the system configuration. Select Discard Changes from the Save & Exit menu and press <Enter>. Select Yes to discard changes.
- **Restore Defaults**
It automatically sets all Setup options to a complete set of default settings when you select this option. Select Restore Defaults from the Save & Exit menu and press <Enter>.
- **Save as User Defaults**
Select this option to save system configuration changes done so far as User Defaults. Select Save as User Defaults from the Save & Exit menu and press <Enter>.
- **Restore User Defaults**
It automatically sets all Setup options to a complete set of User Defaults when you select this option. Select Restore User Defaults from the Save & Exit menu and press <Enter>.
- **Boot Override**
Select a drive to immediately boot that device regardless of the current boot order.

This page is intentionally left blank.

Section 4

Driver and Installation

4.1 Operating System

The GOT315W-521-PCT is compatible with operating systems Windows 10 and Windows 10 IoT Enterprise. To facilitate the installation of system drivers, please carefully read the instructions in this Section before any of such installation.

4.1.1 Driver CD Content

Please download the following GOT312W-521 driver from Axiomtek official website

- 01.Intel chipset
- 02.Intel Graphic_25.20.100.6615
- 03.Intel Lan_23.2
- 04.Intel ME
- 05.Realtek_Audio_6.0.1.8504
- 06.Intel SeralIO
- 07.Intel IRST

4.2 Touch Screen

The GOT315W-521-PCT is designed based on the technology of projected capacitive multi-touch screen of which specifications are listed below. The touch driver will be installed automatically and can drive the touch panel to get two fingers touch function that based on the Windows 10 and Windows 10 IoT Enterprise support.

Table 4-1 Touch screen specifications

Touch Screen	Projected capacitive multi-touch
Touch Screen Controller	TPK_USB Touch Screen Controller IC
Communications	USB interface
Power Supply	5V
Power Consumption	<100mA +10mA
Input Method	Finger or Cap.Stylus
Resolution	25ppi (Min.)_ Note: Base on WIN7 definition, ppi (Pixel per inch)
Win7 USB Driver	Non-Driver
Calibration	Non-Calibration

Appendix A

Watchdog Timer

A.1 About Watchdog Timer

Software stability is major issue in most application. Some embedded systems are not watched by human for 24 hours. It is usually too slow to wait for someone to reboot when computer hangs. The systems need to be able to reset automatically when things go wrong. The watchdog timer gives us solution.

The watchdog timer is a counter that triggers a system reset when it counts down to zero from a preset value. The software starts counter with an initial value and must reset it periodically. If the counter ever reaches zero which means the software has crashed, the system will reboot.

A.2 Sample Program

1. Enter **ADU**, and press <F4> to select the **superior ITE**
2. **PORT** setting **002E, 002F**
3. Address **07h** setting **07 GPIO**
4. Address **72h** to set the countdown, for example Sec: **C0**, Min: **40**
5. Address **73h** set the countdown time, for example 10sec: **0A**

This page is intentionally left blank.

Appendix B

iAMT Settings

Utilizing built-in platform capabilities and popular third-party management and security applications, the Intel® Active Management Technology (Intel® iAMT) has significantly lowered a major barrier to IT management efficiency, helping IT professionals discover, repair and better protect their networked computing assets.

In order to utilize Intel® iAMT you must enter the ME BIOS (<Ctrl + P> during system startup), change the ME BIOS password, and then select "Intel® iAMT" as the manageability feature.

B.1 Entering MEBx

1. You must go to BIOS to enable iAMT function.
2. Exit from BIOS after starting iAMT, and press <Ctrl + P> to enter MEBx Setting.



NOTE: It is advised to press <Ctrl + P> before the screen pops out.

B.2 Set and Change Password

1. You will be asked to set a password when first logging in. The default password is "admin".

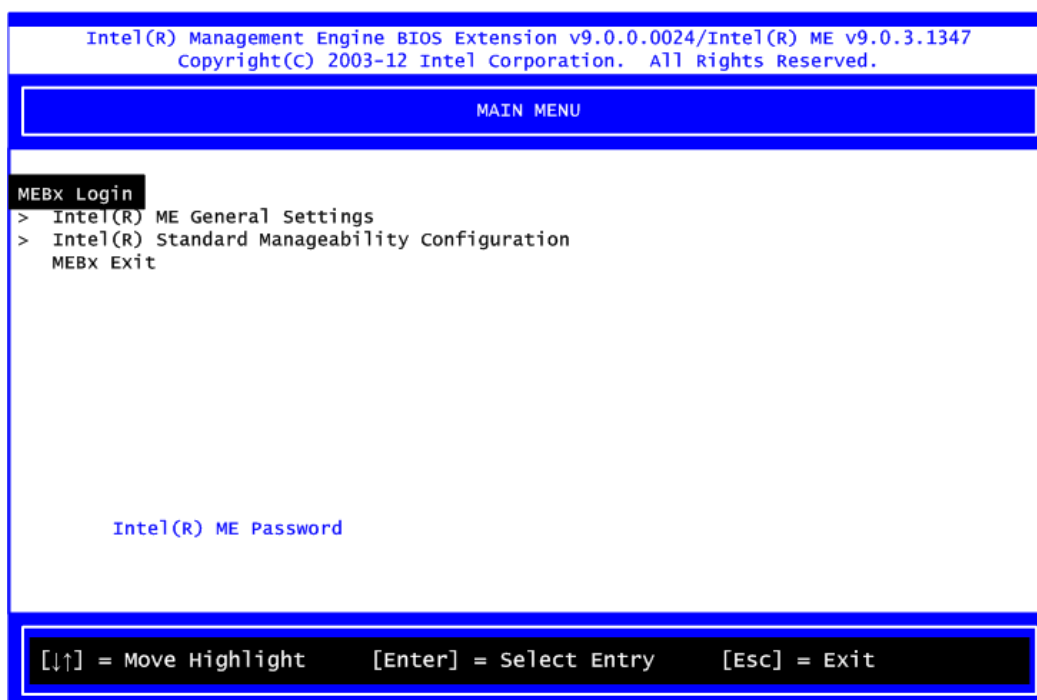

2. You will be asked to change the password before setting ME.

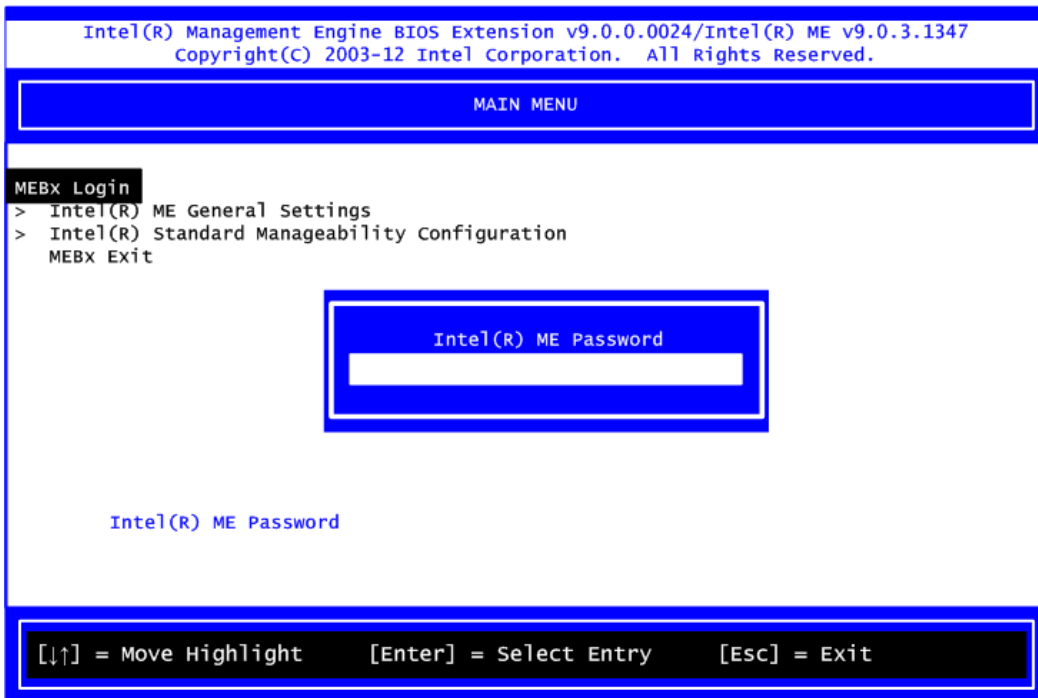

3. You must confirm your new password while revising. The new password must consist of eight characters, including at least:

- One upper case
- One lower case
- One number
- One special symbol, such as ! , ` \$ or ; , (, " , , excepted)

The default value demonstrates an example of a valid password: **!!11qqQQ**

Underline (_) and space are valid characters for password, but they won't make higher complexity.

B.3 iAMT Settings

Select Intel® iAMT configuration and press <Enter>.

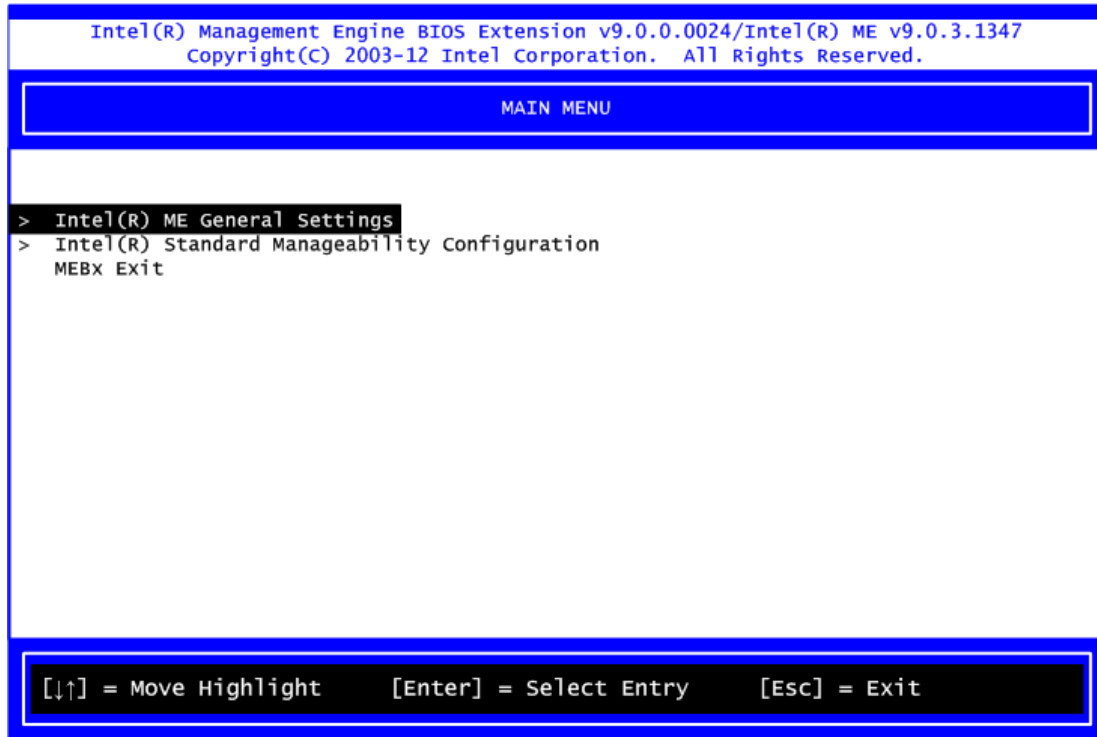

1. Select Network Setup to configure iAMT.

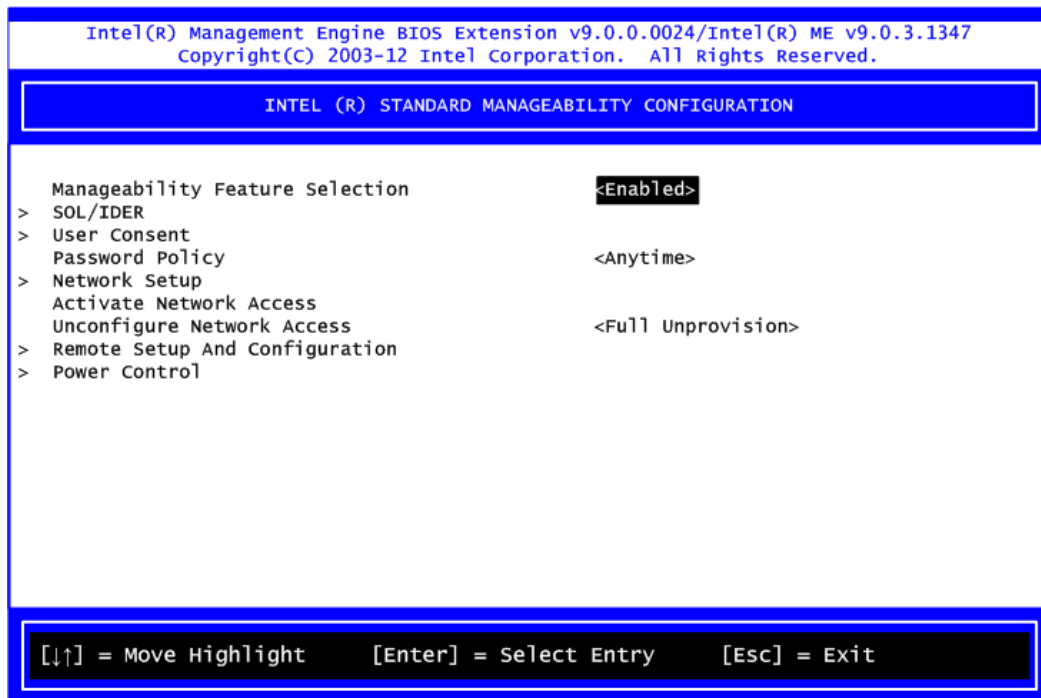

2. Select TCP/IP to get into Network interface and set it to Enabled. Get into DHCP Mode and set it to Disabled.

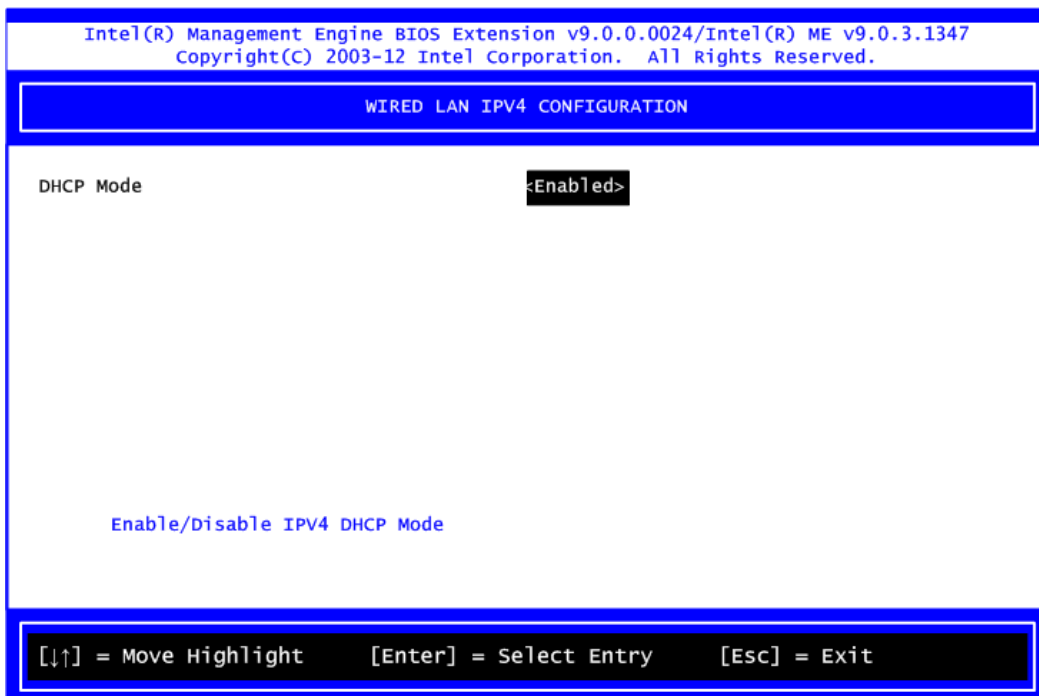
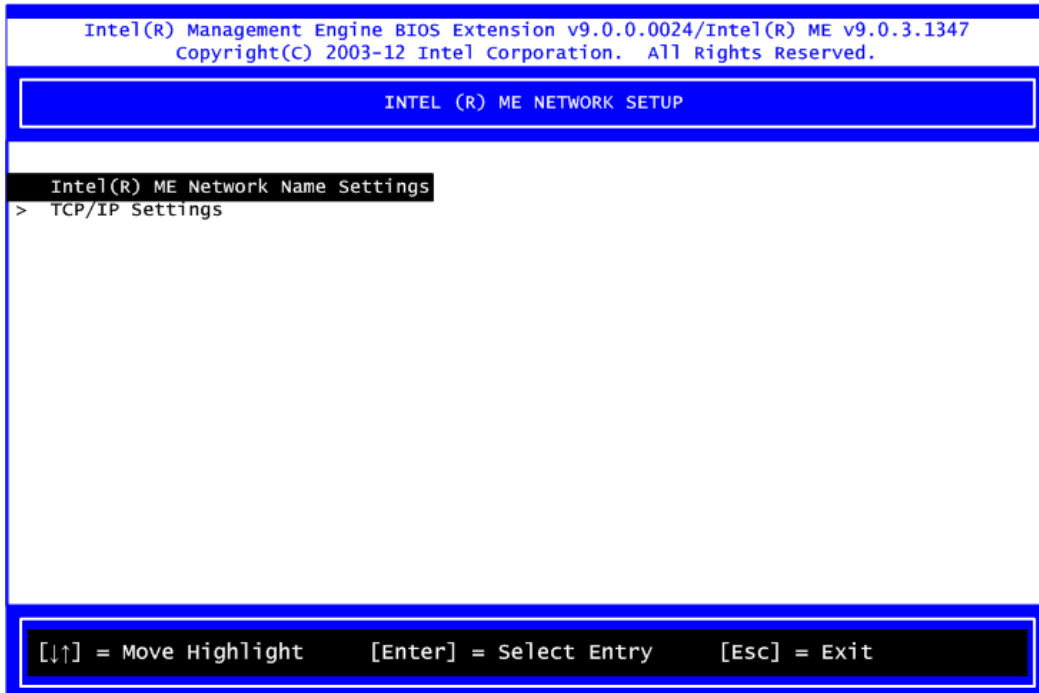

3. If DHCP Mode is disabled, set the following settings:

- IP address
- Subnet mask

Intel(R) Management Engine BIOS Extension v9.0.0.0024/Intel(R) ME v9.0.3.1347
Copyright(C) 2003-12 Intel Corporation. All Rights Reserved.

WIRELESS LAN IPV4 CONFIGURATION

DHCP Mode <Disabled>
IPV4 Address 10.1.40.214
Subnet Mask Address 255.255.255.0
Default Gateway Address 0.0.0.0
Preferred DNS Address 0.0.0.0
Alternate DNS Address

Subnet mask (e.g. 255.255.255.0)
255.255.255.0_

<Enter> = Complete Entry [Esc] = Discard Changes

4. Go back to Intel® iAMT Configuration, then select Activate Network Access and press <Enter>.

Intel(R) Management Engine BIOS Extension v9.0.0.0024/Intel(R) ME v9.0.3.1347
Copyright(C) 2003-12 Intel Corporation. All Rights Reserved.

INTEL (R) STANDARD MANAGEABILITY CONFIGURATION

Manageability Feature Selection <Enabled>
> SOL/IDER
> User Consent
> Password Policy <Anytime>
> Network Setup
Activate Network Access
Unconfigure Network Access
> Remote Setup And Configuration
> Power Control

Activates the current network settings
and opens the ME network interface
Continue: (Y/N)

[↑↓] = Move Highlight [Enter] = Select Entry [Esc] = Exit

5. Exit from MEBx after completing the iAMT settings.

B.4 iAMT Web Console

1. On a web browser, type [http://\(IP ADDRESS\):16992](http://(IP ADDRESS):16992), which connects to iAMT Web.

Example: <http://10.1.40.214:16992>

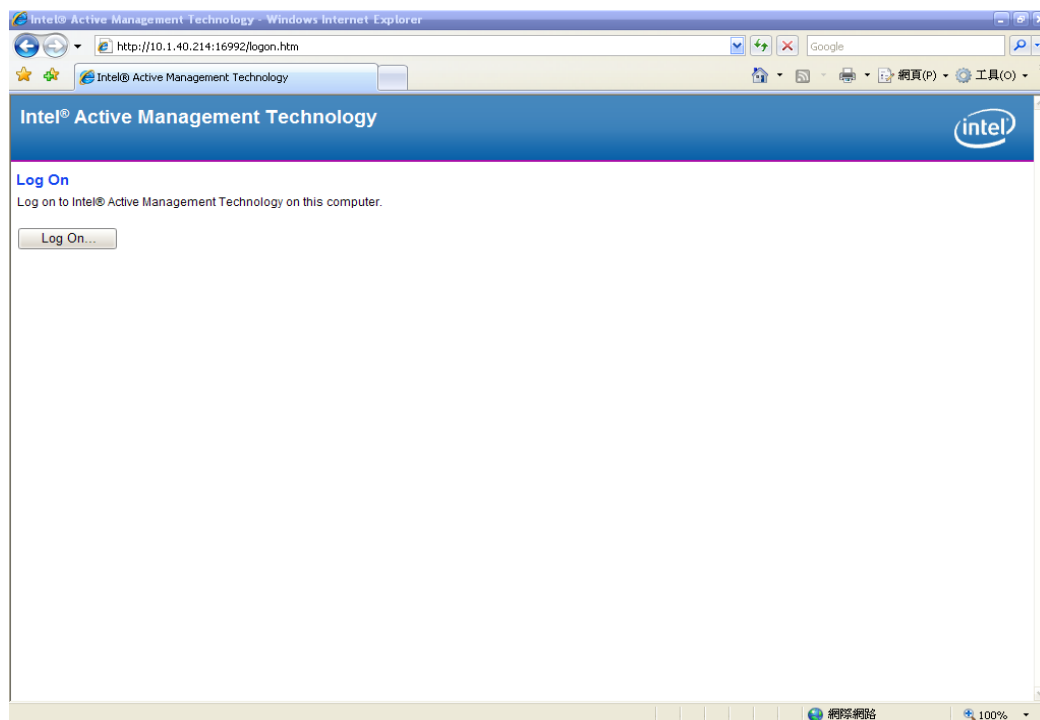

2. To log on, you will be required to type in username and password for access to the Web.

USER: admin (default value)

PASS: (MEBx password)

3. Enter the iAMT Web.

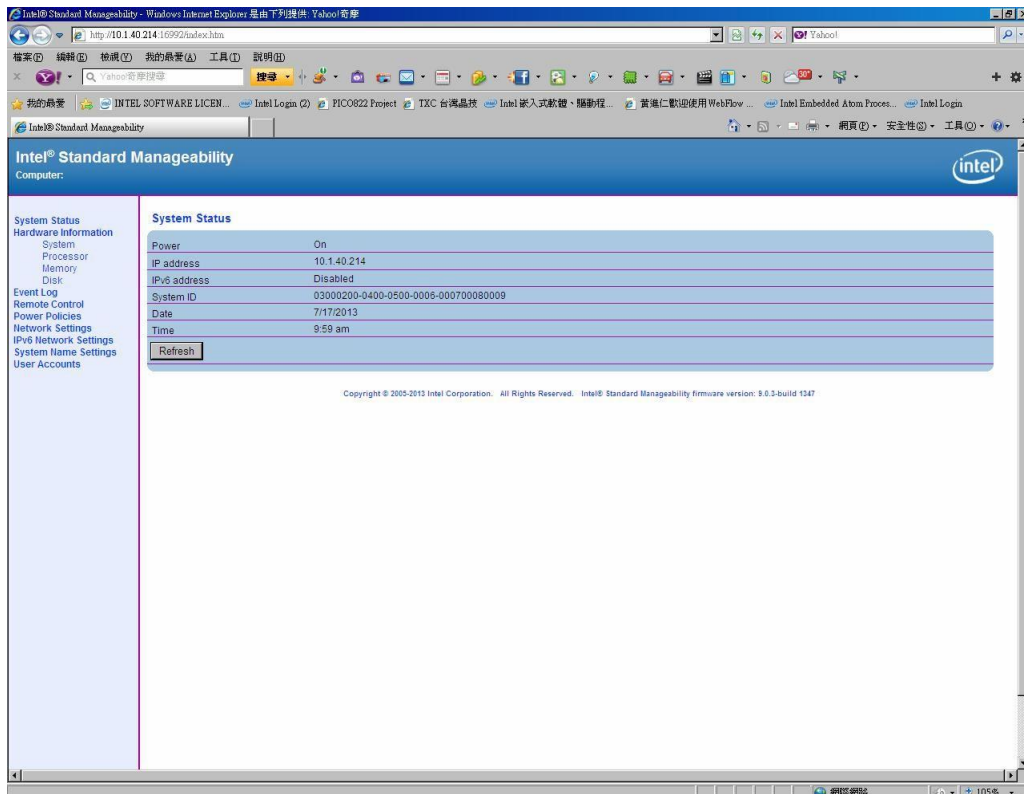

4. Click Remote Control, and select commands on the right side.

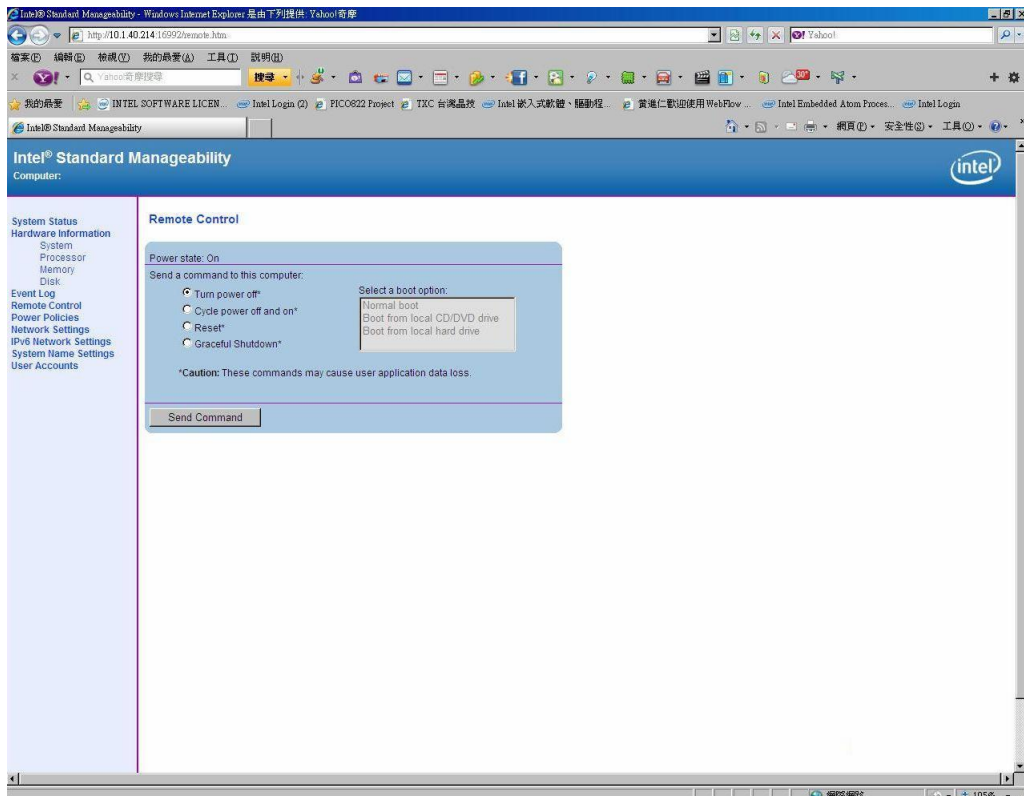

5. When you have finished using the iAMT Web console, close the Web browser.

This page is intentionally left blank.

Appendix C

TPM Settings

1. Setup BitLocker Drive Encryption main storage. Press <Win + R> and type "Control Panel", then select BitLocker Drive Encryption.

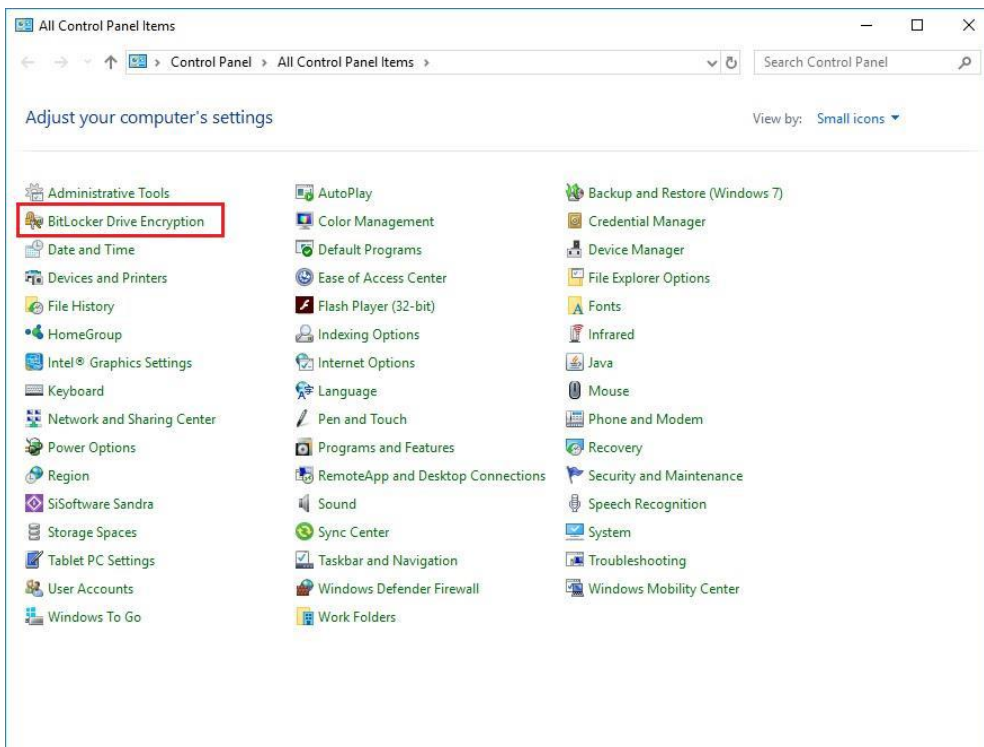
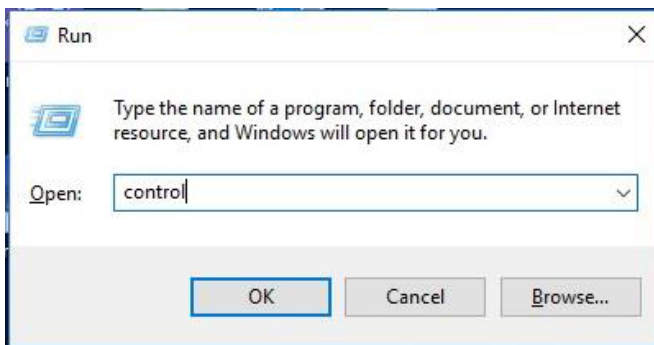

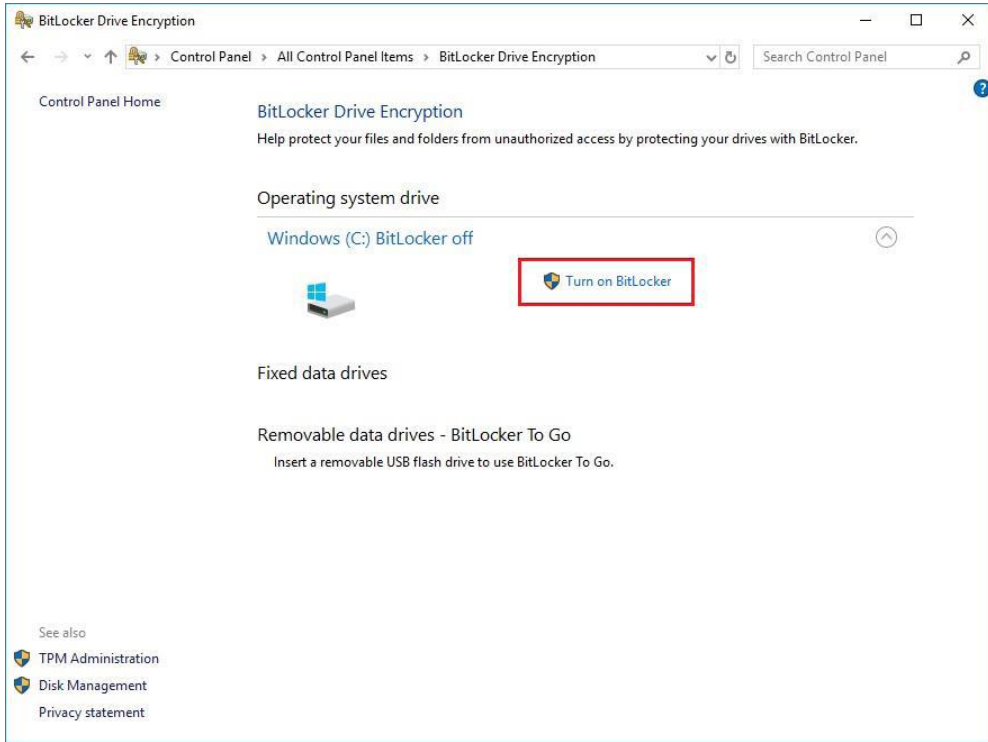

2. Insert an external storage device, for example USB Storage. Back up BitLocker recovery key in a new file and save it to the USB Storage.

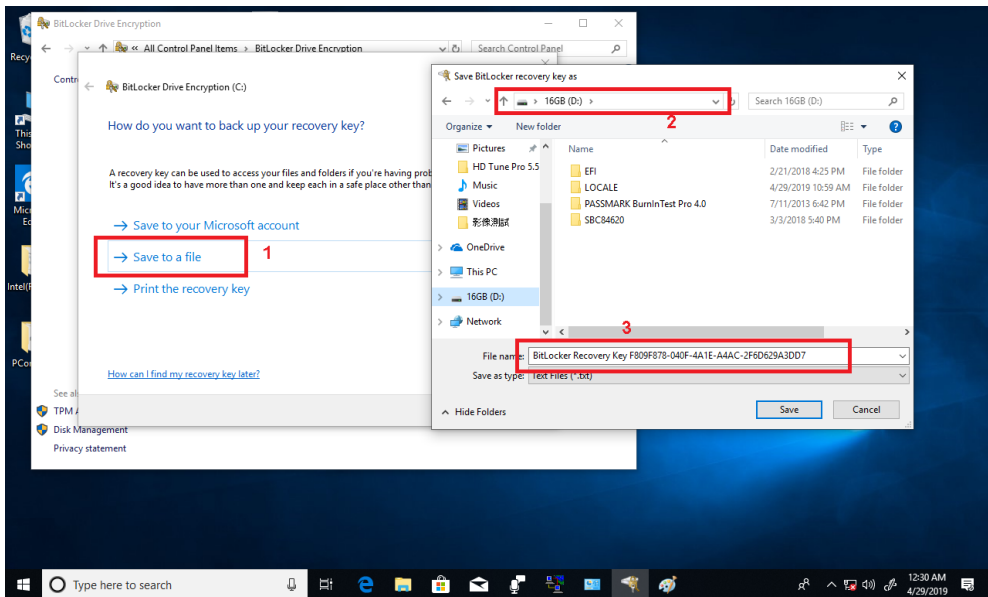

3. Please follow the steps below to encrypt your storage device:

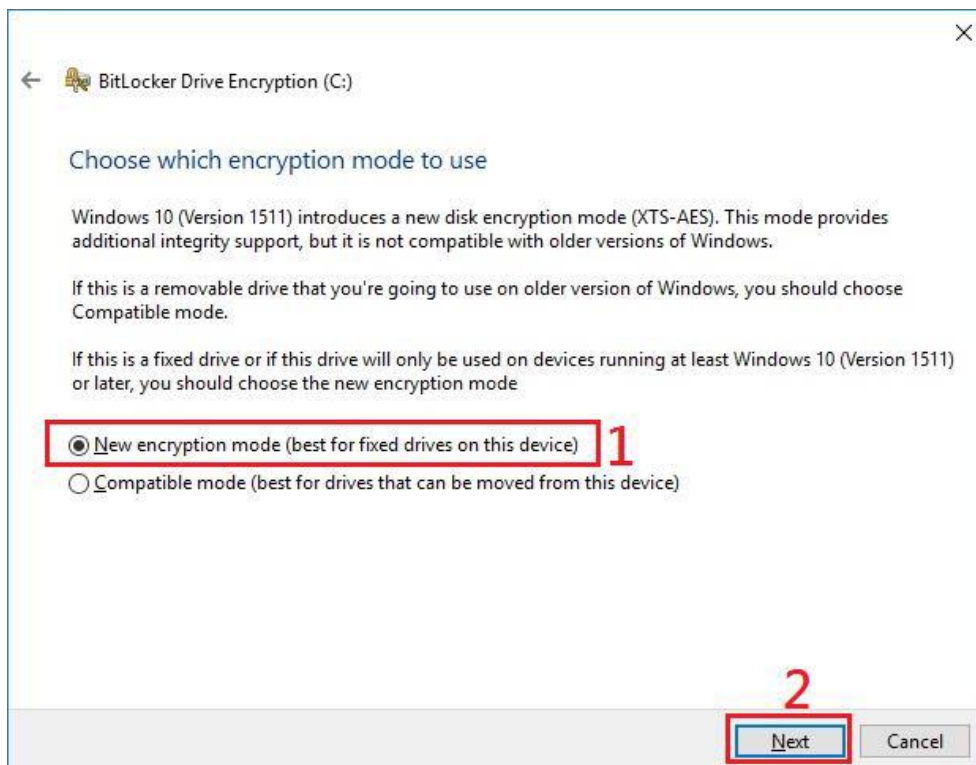
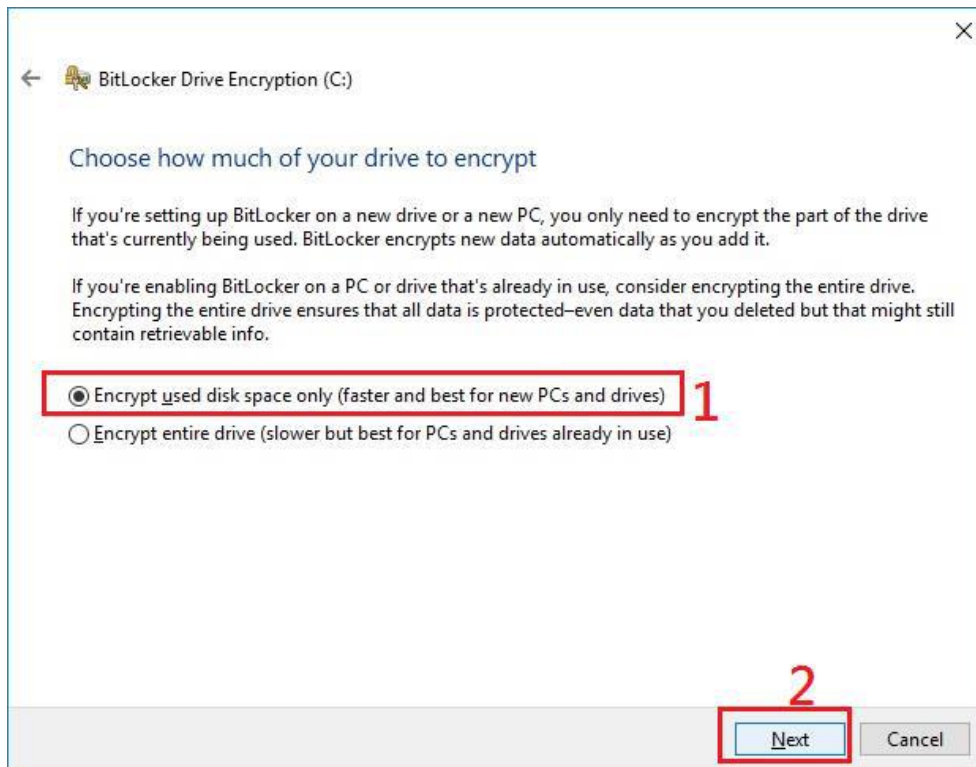

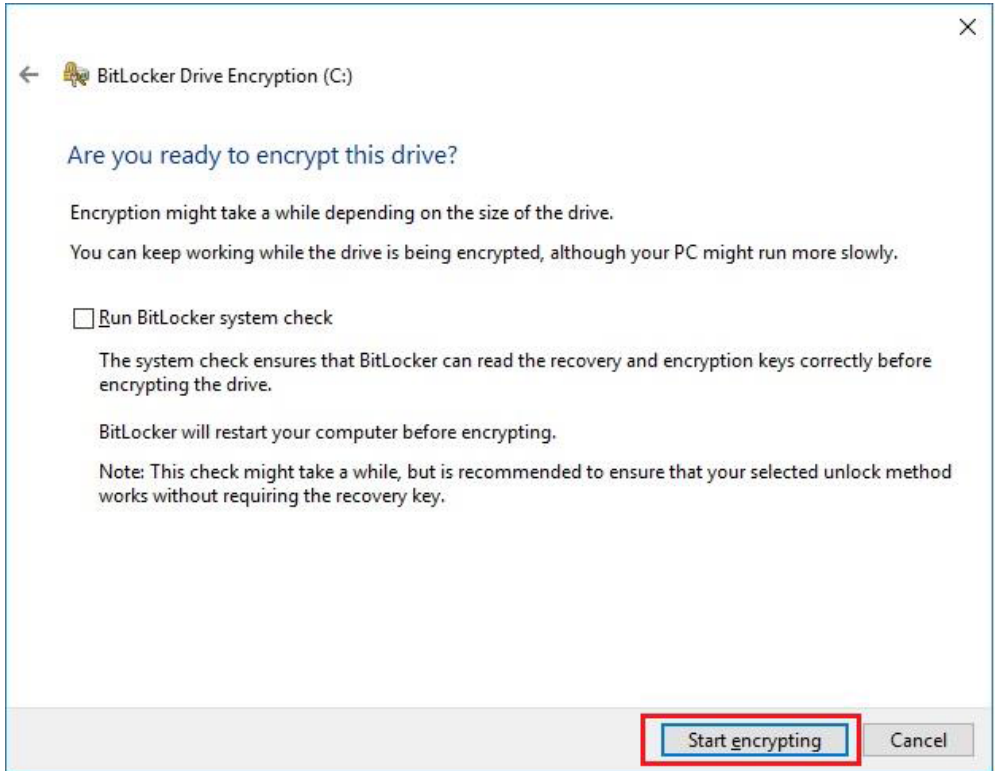

Now, the system prompts that the operating system drive encryption is in progress, and the encryption progress is checked.

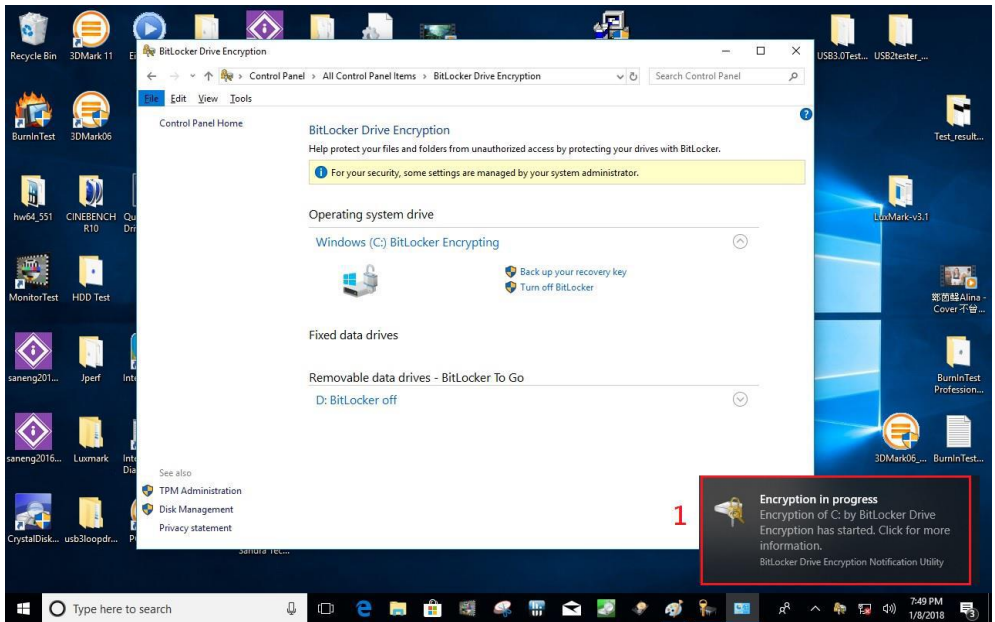

Select and click the icon in the lower right corner to complete the encryption.

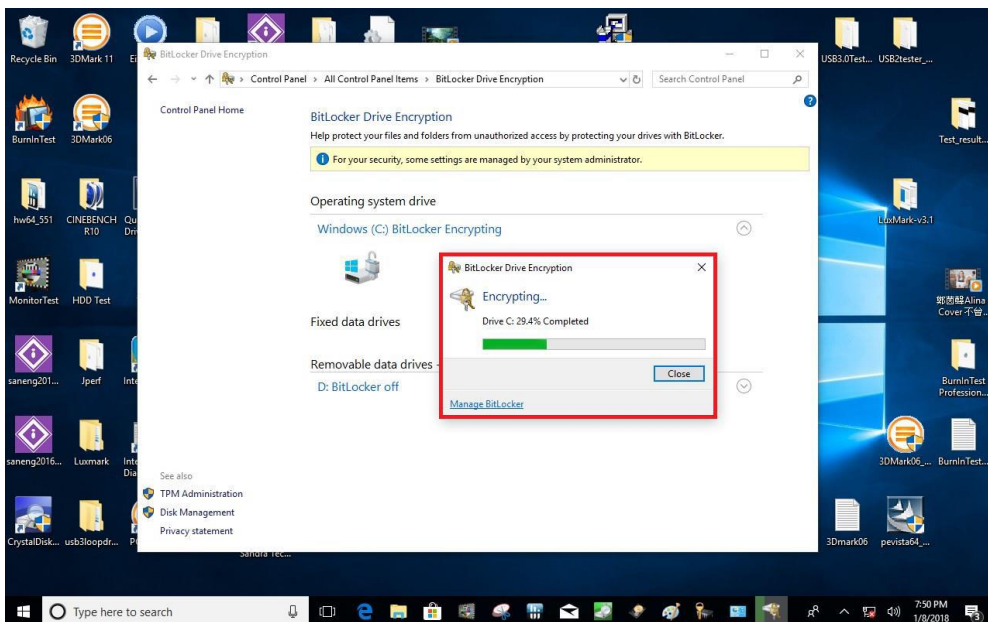
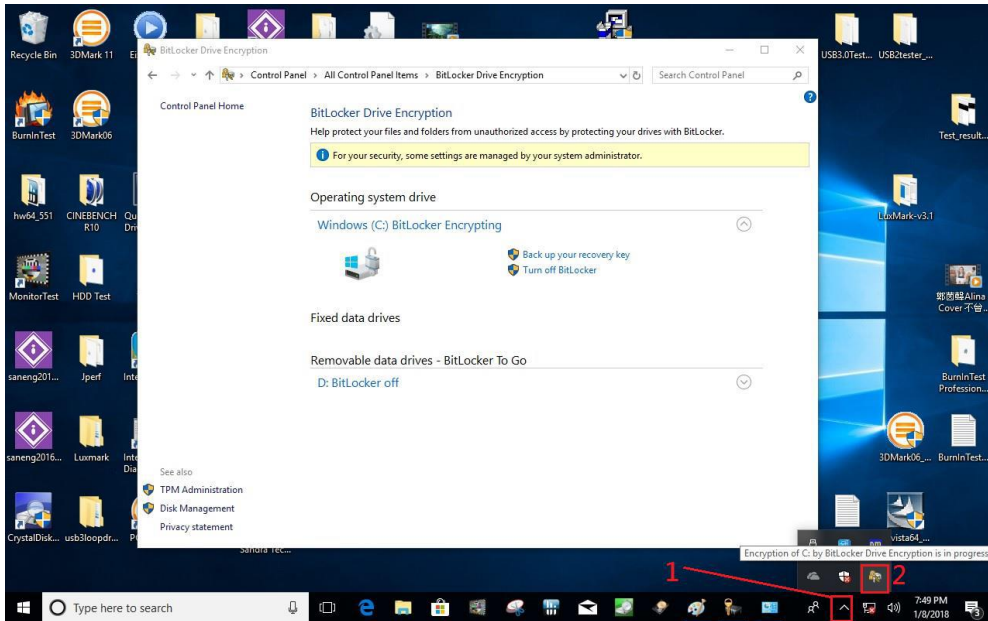

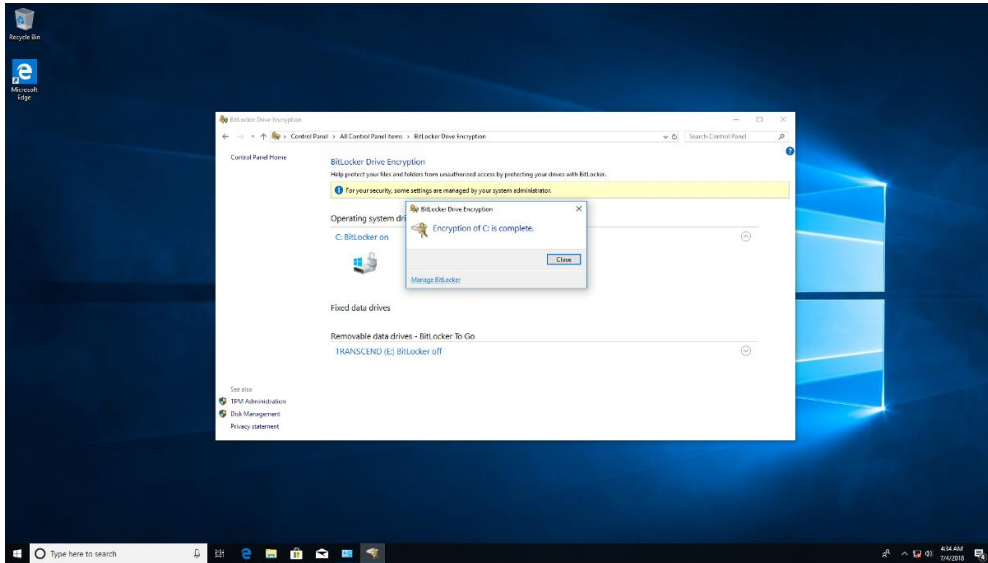

4. Confirm the completion of encryption.

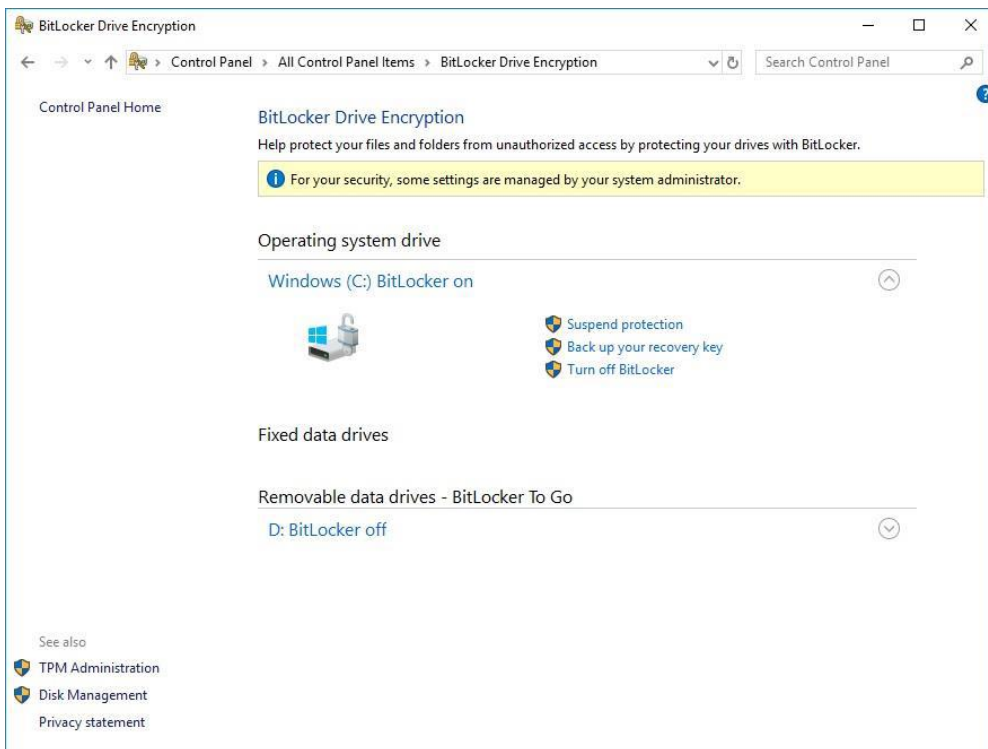

5. Disable TPM function in BIOS Setup Utility.

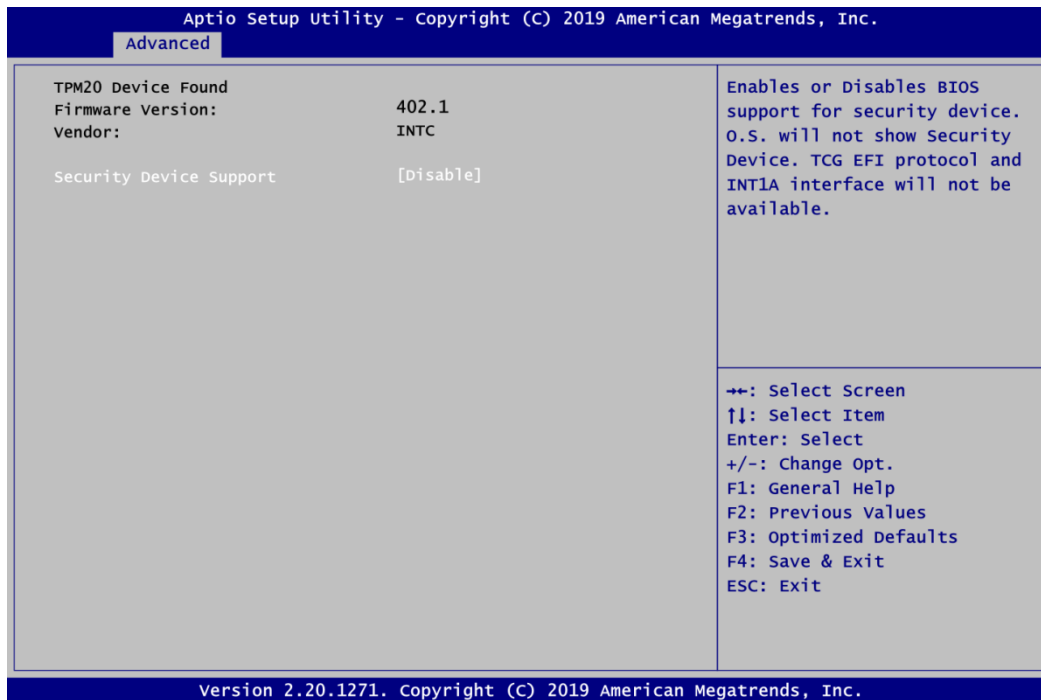

6. When the system is powered on and you see the following screen, it means the TPM module function is working fine. Note that BitLocker cannot be executed if your system does not have TPM function.





NOTE: System with no TPM function support is as below:

1. **TPM information is not found in Device Manager.**



2. **When trying to turn on Bitlocker, the following error message shows up.**

