

HDMI Optical Extender

USER MANUAL

VE882 / VE892

EMC Information

FEDERAL COMMUNICATIONS COMMISSION INTERFERENCE STATEMENT: This equipment has been tested and found to comply with the limits for a Class A digital device, pursuant to Part 15 of the FCC Rules. These limits are designed to provide reasonable protection against harmful interference when the equipment is operated in a commercial environment. This equipment generates, uses, and can radiate radio frequency energy and, if not installed and used in accordance with the instruction manual, may cause harmful interference to radio communications. Operation of this equipment in a residential area is likely to cause harmful interference in which case the user will be required to correct the interference at his own expense.

The device complies with Part 15 of the FCC Rules. Operation is subject to the following two conditions: (1) this device may not cause harmful interference, and (2) this device must accept any interference received, including interference that may cause undesired operation.

FCC Caution: Any changes or modifications not expressly approved by the party responsible for compliance could void the user's authority to operate this equipment.

CE Warning: This is a class A product. In a domestic environment this product may cause radio interference in which case the user may be required to take adequate measures.

RoHS

This product is RoHS compliant.

KCC Statement

유선 제품용 / A 급 기기 (업무용 방송 통신 기기)
이 기기는 업무용 (A 급) 전자파적합기기로서 판매자 또는 사용자는 이 점을 주의하시기 바라며, 가정 외의 지역에서 사용하는 것을 목적으로 합니다.



VE882 / VE892 User Manual

Online Registration

International	http://eservice.aten.com
---------------	---

Telephone Support

International	886-2-8692-6959
China	86-400-810-0-810
Japan	81-3-5615-5811
Korea	82-2-467-6789
North America	1-888-999-ATEN ext 4988 1-949-428-1111

Technical Support

- ◆ For international online technical support – including troubleshooting, documentation, and software updates:
<http://eservice.aten.com>
- ◆ For North American technical support:

Email Support		support@aten-usa.com
Online Technical Support	Troubleshooting Documentation Software Updates	http://www.aten-usa.com/support
Telephone Support		1-888-999-ATEN ext 4998

Package Contents

The VE882 / VE892 package contains the following items:

- ◆ 1 VE882T or VE892T
- ◆ 1 VE882R or VE892R
- ◆ 1 IR Transmitter
- ◆ 1 IR Receiver*
- ◆ 1 Mounting kit
- ◆ 2 Power Adapters
- ◆ 1 User Instructions*

Check to make sure that all the components are present and that nothing got damaged in shipping. If you encounter a problem, contact your dealer.

Read this manual thoroughly and follow the installation and operation procedures carefully to prevent any damage to the unit, and/or any of the devices connected to it.

* The device supports full frequency IR signals from 30kHz to 60kHz. The IR receiver cable included with the package, however, only supports signals from 30kHz to 56 kHz.

Features may have been added to the VE882 / VE892 since this manual was published. Please visit our website to download the most up-to-date version of the manual.

© Copyright 2019 ATEN® International Co., Ltd.

Manual Date: 29 April 2019 11:00am

F/W Version: V1.3.121

ATEN and the ATEN logo are trademarks of ATEN International Co., Ltd. All rights reserved. All other trademarks are the property of their respective owners.

Overview

The VE882 / VE892 is an HDMI Optical Extender that overcomes the length restriction of standard HDMI cables by using optical fiber to send high definition audio and video signals over large distances.

It accepts an audio-video stream from a local source and serializes the data to pass it over a single 3.125 Gbps optical link (for resolutions up to 1080p@60Hz with 24-bit color).

The VE882 / VE892 can also extend the IR remote control and transfer RS-232 signals (up to 115kbps) in both directions, allowing you to connect serial devices, such as touch screens and barcode scanners.

Features

- ◆ Extends the transmission range of HDMI, IR and RS-232 signals using one fiber optic cable
- ◆ Very long distance transmission – up to 600m for VE882, up to 20km for VE892*
- ◆ HDMI (3D, Deep Color), HDCP compatible – signaling rates up to 3.125 Gbits
- ◆ Superior video quality – up to 1080p@60Hz
- ◆ Supports full frequency IR signals from 30 KHz to 60 KHz*
- ◆ A bi-directional IR channel for IR signal control; IR transmission is processed one way at a time
- ◆ Uses one fiber optic cable to connect the local and remote units
- ◆ Supports wide screen formats
- ◆ Built-in 8KV/15KV ESD protection
- ◆ Features RS-232 serial port for connecting peripherals such as touch screens, barcode scanners, etc.
- ◆ Rack-mountable
- ◆ Hot-pluggable

-
- Note:**
1. The VE882 supports OM3 optical fiber which can extend the transmission distance up to 300 meters.
 2. The device supports full frequency IR signals from 30kHz to 60kHz. The IR receiver cable included with the package, however, only supports signals from 30kHz to 56 kHz.
-

Display

- ◆ An HDMI display with HDMI Type A input connector

Source

- ◆ Video source with an HDMI Type A output connector

Cables

- ◆ Fiber optic cable (LC, single mode) to connect the Transmitter and Receiver VE882 / VE892 units*
- ◆ 1 HDMI cable for the source device you will be connecting**
- ◆ 1 HDMI cable for the display device you will be connecting**
- ◆ If you wish to utilize the VE882 / VE892's high-end serial controller function, you need to purchase an appropriate RS-232 cable.

-
- Note:**
1. It is recommended that you use a Single Mode fiber optic cable that conforms to IEC 60793-2-50 B1.1 or ITU-T G.652.B specifications.
 2. No cables are included in this package. We strongly recommend that you purchase high-quality cables of appropriate length since this will affect the quality of the audio and video display. Contact your dealer to purchase the correct cable sets.
-

Components

Top View

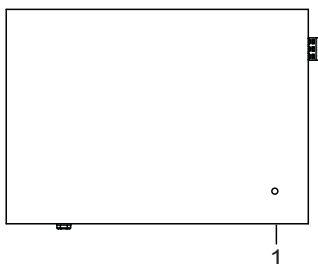

No.	Component	Description
1	Power / Link LED	The LED blinks to indicate that the unit is receiving power. The LED lights to indicate that the fiber optic cable is detected, and communication between the transmitter and receiver is reliable.

Front View

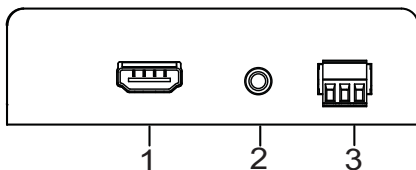

No.	Component	Description
1	HDMI Input/ Output Port	The cable from your HDMI source device plugs into the HDMI Input port (VE882T / VE892T). The cable from your HDMI display device plugs into this HDMI Output port (VE882R / VE892R).
2	IR Port	Plug your IR Transmitter/Receiver here to transmit/receive signals to/from the IR remote control.
3	RS-232 Port (Tx/Rx/Gnd)	Connect a computer or high-end system controller via this serial port.

Rear View

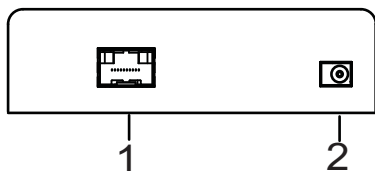

No.	Component	Description
1	Optical In/Out Port*	The fiber optic cable that connects the transmitter and receiver units plugs in here.
2	Power Jack	The power adapter cable plugs in here.

*The Optical In/Out port's color varies as follows:

- ◆ VE882T - Blue
- ◆ VE882R - Yellow
- ◆ VE892T - Purple
- ◆ VE892R - White

Wall Mounting

For convenience and flexibility, the VE882 / VE892 can be mounted on the wall. To mount a unit do the following:

1. Using the screws provided in the Mounting Kit, screw the mounting brackets onto the side panels of the unit as shown in the diagram below:

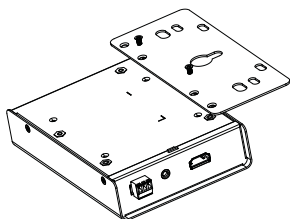

Note: We recommend that you use M5 x 12 Phillips Type I cross, recessed type screws.

2. Attach the bracket onto any convenient location on the wall.

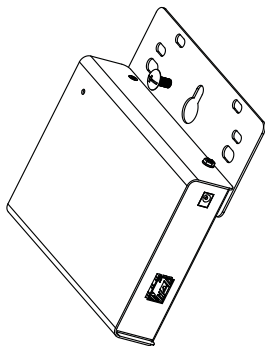

Installation



1. Make sure that the power to any device that you connect to the installation has been turned off. You must unplug the power cords of any computers that have the *Keyboard Power On* function.
2. Make sure that all devices you will be installing are properly grounded.
3. Do not look directly at the light coming from the fiber optic connectors and cable as it is harmful to the eyes.

Refer to the installation diagram on the next page (the numbers in the diagram correspond to the numbers of the steps) and do the following:

1. Connect the HDMI input port on the VE882T/VE892T to the HDMI output port on your video source device using HDMI cable.
2. Connect one end of the fiber optic cable (LC, single mode) to the Optical Out port on the VE882T/VE892T.
3. Connect the other end of the fiber optic cable (LC, single mode) to the Optical In port on the VE882R/VE892R.
4. Use an HDMI Cable to connect your video display to the HDMI output port on the VE882R/VE892R.
5. Plug the power adapter cable into the power jack on the VE882/VE892.
6. (Optional) Connect your computer or controller system (RS-232 Port) to the terminal block on the VE882/VE892 to perform serial commands.
7. a. Connect an IR Transmitter/Receiver to the IR port on the VE882T/VE892T.
b. Connect an IR Transmitter/Receiver to the IR port on the VE882R/VE892R.

Note: The IR transmitter or IR receiver can be plugged into either the VE882T/VE892T or VE882R/VE892R unit depending on the device you want to control remotely.

VE882R/VE892R

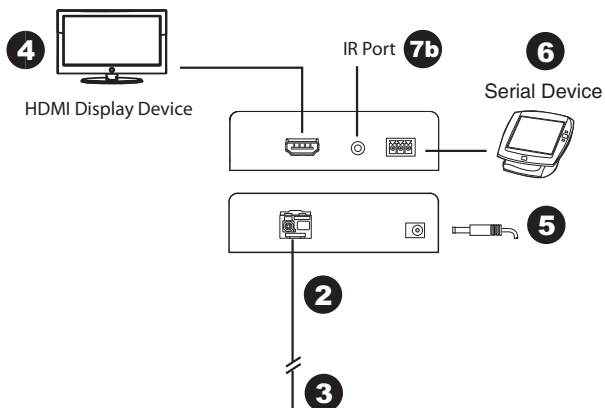

VE882T/VE892T

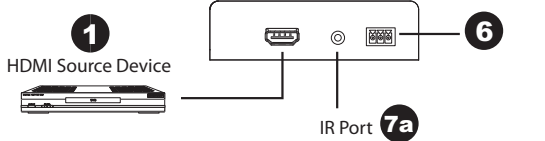

RS-232 Channel Transmission

The RS-232 signal transmission flow is shown in the following illustration:

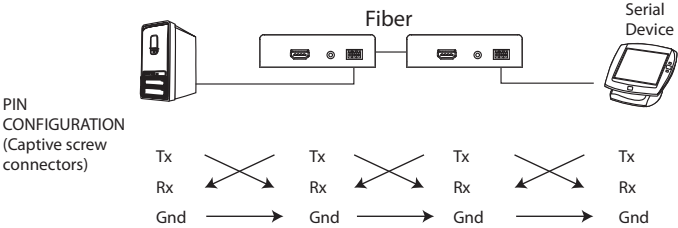

From a source device, the RS-232 signal is transmitted (Tx) to the VE882T/VE892T receiving (Rx) unit; the VE882R/VE892R transmits (Tx) signals to the display device (Rx).

Specifications

Function		VE882T/VE892T	VE882R/VE892R
Connectors	HDMI In	1 x HDMI Type A Female (Black)	N/A
	HDMI Out	N/A	1 x HDMI Type A Female (Black)
	Optical In/Out	1 x LC Simplex Connector (SFP) (Bi-directional)*	
	RS-232	1 x Terminal Block, 3 pole	
	IR	1 x mini stereo jack (Black)	
	Power	1 x DC jack (Black)	
Fiber Optics	Operating distance**	VE892: 20 km with single mode (SM) fiber VE882: 600 m with single mode (SM) fiber	
	Wavelength	1310/1550 nm for SM	
	Data rate	Single fiber: 1080p/60Hz (24-bits, 3.125G bps)	
LEDs	Link	1 (Green)	
Power Consumption		DC5.3V:5.8W:27BTU	DC5.3V:4.69W:22BTU
Environment	Operating Temp.	0–50°C	
	Storage Temp.	-20–60°C	
	Humidity	0–80% RH, Non-condensing	
Physical Properties	Housing	Metal	
	Weight	0.42 kg	
	Dimensions (L x W x H)	14.17 x 10.30 x 3.0cm	

- Note:**
- The optical fiber modules are color-coded accordingly:
 - ◆ VE882T Blue
 - ◆ VE882R Yellow
 - ◆ VE892T Purple
 - ◆ VE892R White
 - Operating distance is approximate. These are typical maximum distances that may vary depending on factors such as fiber type, fiber bandwidth, connector splicing, losses, modal or chromatic dispersion, environmental factors and kinks.
 - It is recommended that you use a Single Mode fiber optic cable that conforms to the IEC 60793- 2-50 B.1.1 or ITU-T G.652.B specifications.
 - The VE882 supports OM3 optical fiber which can extend the transmission distance up to 300 meters.

Limited Warranty

ATEN warrants its hardware in the country of purchase against flaws in materials and workmanship for a Warranty Period of two [2] years (warranty period may vary in certain regions/countries) commencing on the date of original purchase. This warranty period includes the LCD panel of ATEN LCD KVM switches. Select products are warranted for an additional year (see *A+ Warranty* for further details). Cables and accessories are not covered by the Standard Warranty.

What is covered by the Limited Hardware Warranty

ATEN will provide a repair service, without charge, during the Warranty Period. If a product is defective, ATEN will, at its discretion, have the option to (1) repair said product with new or repaired components, or (2) replace the entire product with an identical product or with a similar product which fulfills the same function as the defective product. Replaced products assume the warranty of the original product for the remaining period or a period of 90 days, whichever is longer. When the products or components are replaced, the replacing articles shall become customer property and the replaced articles shall become the property of ATEN.

To learn more about our warranty policies, please visit our website:

<http://www.aten.com/global/en/legal/policies/warranty-policy/>