



**4-port USB DVI-D KVMP™ Control Center
CM1164
User Manual**



EMC Information

FEDERAL COMMUNICATIONS COMMISSION INTERFERENCE STATEMENT: This equipment has been tested and found to comply with the limits for a Class A digital device, pursuant to Part 15 of the FCC Rules. These limits are designed to provide reasonable protection against harmful interference when the equipment is operated in a commercial environment. This equipment generates, uses, and can radiate radio frequency energy and, if not installed and used in accordance with the instruction manual, may cause harmful interference to radio communications. Operation of this equipment in a residential area is likely to cause harmful interference in which case the user will be required to correct the interference at his own expense.

The device complies with Part 15 of the FCC Rules. Operation is subject to the following two conditions: (1) this device may not cause harmful interference, and (2) this device must accept any interference received, including interference that may cause undesired operation.

FCC Caution: Any changes or modifications not expressly approved by the party responsible for compliance could void the user's authority to operate this equipment.

CE Warning: This is a class A product. In a domestic environment this product may cause radio interference in which case the user may be required to take adequate measures.

KCC Statement

유선 제품용 / A 급 기기 (업무용 방송 통신 기기)
이 기기는 업무용 (A 급) 전자파적합기기로서 판매자 또는 사용자는 이 점을 주의하시기 바라며 , 가정 외의 지역에서 사용하는 것을 목적으로 합니다 .

RoHS

This product is RoHS compliant.



SJ/T 11364-2006

The following contains information that relates to China.

部件名称	有毒有害物质或元素					
	铅	汞	镉	六价铬	多溴联苯	多溴二苯醚
电器部件	●	○	○	○	○	○
机构部件	○	○	○	○	○	○

- : 表示该有毒有害物质在该部件所有均质材料中的含量均在SJ/T 11363-2006规定的限量要求之下。
- : 表示符合欧盟的豁免条款, 但该有毒有害物质至少在该部件的某一均质材料中的含量超出SJ/T 11363-2006的限量要求。
- ×: 表示该有毒有害物质至少在该部件的某一均质材料中的含量超出SJ/T 11363-2006的限量要求。

User Information

Online Registration

Be sure to register your product at our online support center:

International	http://eservice.aten.com
---------------	---

Telephone Support

For telephone support, call this number:

International	886-2-8692-6959
China	86-10-5255-0110
Japan	81-3-5615-5811
Korea	82-2-467-6789
North America	1-888-999-ATEN ext 4988
United Kingdom	44-8-4481-58923

User Notice

All information, documentation, and specifications contained in this manual are subject to change without prior notification by the manufacturer. The manufacturer makes no representations or warranties, either expressed or implied, with respect to the contents hereof and specifically disclaims any warranties as to merchantability or fitness for any particular purpose. Any of the manufacturer's software described in this manual is sold or licensed *as is*. Should the programs prove defective following their purchase, the buyer (and not the manufacturer, its distributor, or its dealer), assumes the entire cost of all necessary servicing, repair and any incidental or consequential damages resulting from any defect in the software.

The manufacturer of this system is not responsible for any radio and/or TV interference caused by unauthorized modifications to this device. It is the responsibility of the user to correct such interference.

The manufacturer is not responsible for any damage incurred in the operation of this system if the correct operational voltage setting was not selected prior to operation. PLEASE VERIFY THAT THE VOLTAGE SETTING IS CORRECT BEFORE USE.

Package Contents

The CM1164 package consists of:

- ◆ 1 CM1164 4-port USB DVI-D KVMP™ Control Center
- ◆ 4 Custom KVM Cable Sets (Single Link DVI-D x 1; USB 2.0 x 1; 2.1 audio x 2; length – 1.8m)
- ◆ 1 IEC320 Power Cord
- ◆ 1 IR Remote Control
- ◆ 1 User Instructions*

Check to make sure that all the components are present and that nothing got damaged in shipping. If you encounter a problem, contact your dealer.

Read this manual thoroughly and follow the installation and operation procedures carefully to prevent any damage to the unit, and/or any of the devices connected to it.

* Features may have been added to the CM1164 since this manual was printed. Please visit our website to download the most up-to-date version.

© Copyright 2010–2015 ATEN® International Co., Ltd.

F/W Version: v1.0.097

Manual Date: 2015-04-02

ATEN and the ATEN logo are registered trademarks of ATEN International Co., Ltd. All rights reserved. All other brand names and trademarks are the registered property of their respective owners.

Contents

EMC Information	ii
User Information	iv
Online Registration	iv
Telephone Support	iv
User Notice	iv
Package Contents	v
About this Manual	x
Conventions	xi
Product Information	xi

Chapter 1.

Introduction

Overview	1
Features	3
Requirements	4
Console	4
Computers	4
Cables	4
Operating Systems	5
On-Screen Display (OSD) Languages	5
Optional Equipment	5
Components	6
Front View	6
Rear View	7
IR Remote Control	8

Chapter 2.

Hardware Setup

Rack Mounting	9
Grounding	11
Single Station Installation	11
Single Station Installation Diagram	12
Daisy Chaining	13

Chapter 3.

Basic Operation

Overview	15
Port ID Number	15
Switching	16
Manual Switching	16
Hotkey Switching	18
Remote Switching	18
OSD Switching	19
Display Modes	20

Quad View	21
Picture in Picture - Dual	22
Picture in Picture - Triple	23
Picture in Picture - Quad	24
Display Mode Resolutions	25
Fitting Resolutions	25
Fitting Picture in Picture	25
Fn Pushbuttons	26
Powering Off and Restarting	27
KVM Reset	27

Chapter 4.

Hotkey Operation

Activate the OSD	29
Activate the OSD in Hardware Cursor Mode	29
Hotkey Setting Mode	30
Invoking HSM	30
Auto Scanning	32
Auto Scanning - Display Modes	32
Display Mode	33
Fn Key	33
Hotkey Steps	34
List Current KVM Settings	34
USB Reset	34
Video DynaSync	34
Port Switching	34

Chapter 5.

Channel Editor

Overview	35
Starting the Channel Editor	35
Channel Editor Mouse	36
Channel Editor Control Panel	39
Display Modes	40

Chapter 6.

OSD Operation

Overview	41
OSD Operation and Menu	43
Port Selection	45
Mode Selection	46
Display Modes	46
Quadview	46
Picture in Picture (Dual / Triple / Quad)	47
Configuring Display Modes	48
Disable Channel	48

Quadview Resolution	49
Startup Display Mode	50
DCC	51
System Setting	52
System	52
Hardware Cursor Mode.....	53
OSD Hotkey	54
Hotkey Selection Mode.....	54
Video DynaSync	55
Activate Beeper.....	55
Port ID Display	56
OSD Language.....	56
Keyboard Language	57
Auto Scan	57
Security	58
KVM Status	60
DCC Control	60
Computer	61
Keyboard Emulation	61
Mouse Emulation	62
Power On Detection	62
Set OS.....	63
USB Reset	63
Configuration	64
Fn Key.....	64
Selection	65
Restore Default Values.....	66
Firmware Upgrade	66
OSD Config Backup Restore	67
Backup / Restore.....	67
Help	70
Channel ID	71
Quad View.....	71
PiP Dual	71
PiP Triple.....	71
PiP Quad.....	72

Chapter 7.

Firmware Upgrade

Before you Begin	73
Starting the Upgrade.....	74
Upgrade Succeeded.....	76
Upgrade Failed	76

Appendix

Safety Instructions	77
---------------------------	----

Technical Support	79
International	79
North America	79
Specifications	80
Troubleshooting	81
OSD Access Rights	83
Display Mode Reference	84
Fn Key Reference	85
Mac Keyboard Emulation	86
Sun Keyboard Emulation	87
Factory Default Hotkeys and Settings	88
Limited Warranty	88

About this Manual

This User Manual is provided to help you get the most from your system. It covers all aspects of installation, configuration and operation. An overview of the information found in the manual is provided below.

Chapter 1, Introduction, introduces you to the CM1164 system. Its purpose, features and benefits are presented, and its front and back panel components are described.

Chapter 2, Hardware Setup, describes how to set up your installation. Diagrams showing the necessary steps are provided.

Chapter 3, Basic Operation, explains the fundamental concepts involved in operating the CM1164.

Chapter 4, Keyboard Port Operation, details all of the concepts and procedures involved in the Hotkey operation of your CM1164 installation.

Chapter 5, Channel Editor, provides a complete description of the channel editor mode and how it works.

Chapter 6, OSD Operation, provides a complete description of the CM1164's On-Screen Display (OSD), and how to work with it.

Chapter 7, Firmware Upgrade, explains how to upgrade the CM1164's firmware with the latest available versions.

An Appendix, provides specifications and other technical information regarding the CM1164.

Conventions

This manual uses the following conventions:

- | | |
|---|--|
| Monospaced | Indicates text that you should key in. |
| [] | Indicates keys you should press. For example, [Enter] means to press the Enter key. If keys need to be chorded, they appear together in the same bracket with a plus sign between them: [Ctrl+Alt]. |
| 1. | Numbered lists represent procedures with sequential steps. |
| ◆ | Bullet lists provide information, but do not involve sequential steps. |
| → | Indicates selecting the option (on a menu or dialog box, for example), that comes next. For example, Start → Run means to open the <i>Start</i> menu, and then select <i>Run</i> . |
|  | Indicates critical information. |

Product Information

For information about all ATEN products and how they can help you connect without limits, visit ATEN on the Web or contact an ATEN Authorized Reseller. Visit ATEN on the Web for a list of locations and telephone numbers:

International	http://www.aten.com
North America	http://www.aten-usa.com

This Page Intentionally Left Blank

Chapter 1

Introduction

Overview

To improve operational efficiency in control rooms, there needs to be a fast and convenient way to view and manage more computers simultaneously, permitting faster response times from a single location. In addition, the solution must save space and eliminate the need for extra keyboards, mice, and monitors.

The CM1164 4-port USB DVI-D KVM Control Center charts a revolutionary new direction in KVM switch functionality by combining a 4-port DVI-D switch with a 2-port USB hub, and providing the following Display Modes: Quad View mode, which simultaneously displays four digital computers/video sources on a single screen; as well as Picture in Picture mode (Dual, Triple or Quad) and Full Screen mode; see *Display Modes*, page 20. There are many ways to control and switch between computers/video sources – simply select which source you want to view on the console display by these convenient access methods: via the front panel pushbuttons, using an IR remote control, through the On-Screen Display (OSD) or through hotkey combinations entered from the console keyboard.

The CM1164 allows users to access 4 computers/devices from a single console, consisting of a USB keyboard, USB mouse and DVI-D monitor. As USB hub, it permits each computer to access connected peripherals on a one-computer-at-a-time basis. The CM1164's independent switching feature allows the KVM focus to be one computer while the USB peripheral focus is on another. There is no need to purchase a separate USB hub, as well as separate stand-alone peripheral sharers.

The CM1164 further improves on previous designs with DVI-D connectors, and the transfer of keyboard and mouse data to the computers via a fast, reliable USB connection. As with the USB peripherals, the audio focus can be independent of the KVM focus.

A Daisy Chain Control (DCC) port allows a user to connect and control up to four CM1164 units via a single console. This enables the use of only one keyboard/mouse over several computers or another CM1164. This is convenient for growing networks that need to monitor and manage more computers – daisy chain up to four units and switch between up to 16 computers/video sources.

Setup is fast and easy; simply plug cables into their appropriate ports. There is no software to configure, no installation routines, and no incompatibility problems. Since the CM1164 intercepts keyboard input directly, it will work on Microsoft Windows, Linux, Sun and Mac platforms.

In addition, the firmware upgrade by USB interface simplifies the process and ensures your CM1164 is up-to-date.

With its unique design and innovative features, the CM1164 4-port USB DVI-D KVMP™ Control Center provides both style and functionality for a wide range of practical applications, including control rooms, monitoring systems and traffic control centers, as well as process control centers, server rooms, medical industries, broadcasting, production and automation, aircraft and vehicles. In combination with projectors, it is also used in presentations and conference rooms. Allowing you to switch seamlessly between four DVI-enabled PCs, and share USB peripherals and high-definition audio from a dual-display console, the CM1164 is ideal for multimedia applications, and offers the ultimate in space-saving, streamlined KVM technology.

Features

- ◆ One console independently and simultaneously controls four DVI-D computers, and two additional USB devices
- ◆ 2-port USB 2.0 hub built in; fully compliant with USB 2.0 specification
- ◆ Multi-view console controls up to 4 video sources on one screen with Display Modes including Quad View mode, Picture in Picture mode (Dual, Triple or Quad), and Full Screen mode
- ◆ Function control via OSD menu – Display Mode, port selection, DCC, etc.
- ◆ DCC (Daisy Chain Control) port enables users to connect up to four CM1164 units, and use one console keyboard/mouse to manage computers or another CM1164
- ◆ Hardware Cursor – control the OSD menu using the console mouse
- ◆ Channel Editor – easily manipulate channel display settings, including the size and position of channel windows, and switching their port numbers
- ◆ Computer selection via front panel push buttons, hotkeys, IR Remote Control and OSD (with mouse* function enabled)
- ◆ Console mouse port emulation/bypass feature that supports most mouse drivers and multifunction mice
- ◆ Console keyboard emulation/bypass feature that support most multimedia keyboards
- ◆ Independent switching of USB peripheral port, audio function, and KVM switch focus
- ◆ Superior video quality – up to 1920 x 1200 resolution
- ◆ Video DynaSync™ – exclusive ATEN technology that eliminates boot-up display problems and optimizes resolution when switching between ports
- ◆ Firmware upgradeable via a computer's USB port
- ◆ Power on detection – if one of the computers is powered off, the CM1164 automatically switches to the next powered-on computer
- ◆ Auto Scan Mode
- ◆ Full bass response provides a rich experience for 2.1 channel audio
- ◆ Multiplatform support – Windows, Linux, Sun and Mac
- ◆ Multilingual keyboard mapping – supports English, Japanese and French keyboards
- ◆ Sun/Mac keyboard support and emulation**

* For 3-key USB wheel mouse only

** PC keyboard combinations emulate Sun/Mac keyboards

** Sun/Mac keyboards only work with their own computers

Requirements

Console

- ◆ A DVI-D Single Link display capable of the highest possible resolution
- ◆ A USB mouse
- ◆ A USB keyboard
- ◆ Microphone and speakers (optional)

Computers

The following must be available on each computer:

- ◆ A DVI port

Note: The quality of the display is affected by the quality of the display card. We recommend you purchase a high quality product.

- ◆ USB Type A port
- ◆ Audio ports (optional)

Cables

- ◆ Custom KVM cable (Single Link DVI-D, 2.1 channel audio, USB 2.0)
- ◆ IEC320 Power Cord
- ◆ RJ-45 cable(s) for Daisy Chain Control
- ◆ IR Extension cable, sold separately

Operating Systems

Supported operating systems are shown in the tables, below:

OS		Version
Windows		2000 and higher
Linux	RedHat	6.0 and higher
	SuSE	8.2 and higher
UNIX	FreeBSD	3.51 and higher
	Sun	Solaris 8 and higher
Novell	Netware	6.0 and higher
Mac		OS 9 and higher

On-Screen Display (OSD) Languages

The CM1164's GUI is in English by default. Other languages supported are: French, German, Japanese and Traditional Chinese.

Optional Equipment

An IR extension cable is available for the CM1164 but is sold separately. To purchase the IR extension cable, contact your ATEN dealer and refer to part # 2XRT-0003G.

Components

Front View

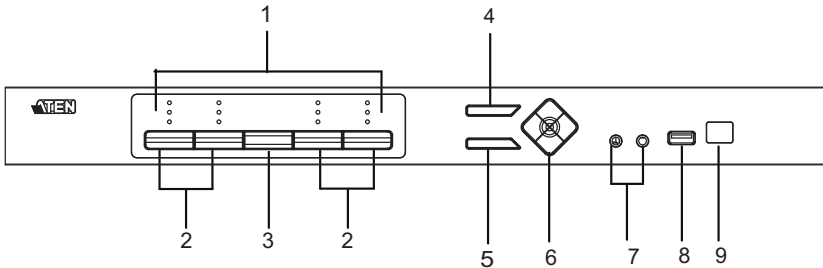

No.	Component	Description
1	LED Status Panel	This panel contains LED icons that light to indicate mode and port status. The Mode and Port Selection Pushbuttons each have three corresponding LED icons that represent audio , KVM , and USB Link status. See <i>Display Modes</i> , page 20, for full details.
2	Port Selection Pushbuttons	<ul style="list-style-type: none"> ◆ Press the Port Selection Pushbuttons to manually switch ports. See <i>Display Modes</i>, page 20, for full details. ◆ Press and hold Port Selection Pushbuttons 1 and 2 simultaneously for <i>2 seconds</i> to start Auto Scan Mode. See <i>Auto Scanning</i>, page 32, for full details. ◆ Press and hold Port Selection Pushbuttons 3 and 4 simultaneously for <i>2 seconds</i> to execute a KVM reset. See <i>KVM Reset</i>, page 27 for full details.
3	Mode Selection Pushbutton	This pushbutton allows you to cycle through the three modes of focus – KVM, audio, and USB Link.
4	OSD (Esc) button	Press this to invoke the on-screen display (OSD) menu. When the OSD menu is enabled, press the OSD button to go back to the previous menu/submenu.
5	Select button	Press this to select an option in the OSD menu.
6	Direction / Function buttons	Use these buttons to switch between Function modes (Fn1 to Fn4), and to cycle through the OSD menu/selection. See <i>IR Remote Control</i> , page 8 for details.
7	Console Audio Ports	Your speakers and microphone plug in here.
8	USB 2.0 Peripheral Port	USB 2.0 peripherals (printers, scanners, etc.) plug into this port.
9	IR Receiver	This receives signals from the IR remote control.

Rear View

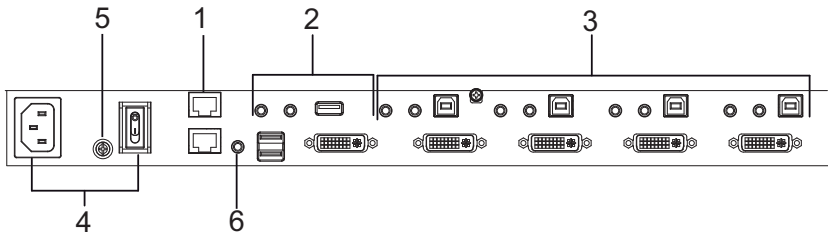

No.	Component	Description
1	Daisy Chain Control In / Out ports	Use these ports to connect to another CM1164's DCC port to pass keyboard and mouse signals. You can daisy chain up to four CM1164 units.
2	Console Port Section	The cables from your USB keyboard, USB mouse, DVI console display, a USB peripheral, microphone and speakers plug into this section.
3	DVI KVM Port Section	The cables that link the CM1164 to your DVI-D Single Link computers plug in here. Each DVI KVM port is comprised of a microphone jack, speaker jack, USB type B socket, and a DVI Single Link connector. You can initiate a firmware upgrade from the computer connected to these ports.
4	Power Socket / Power Switch	Plug in the power cord to the power socket and use the switch to power on the CM1164.
5	Grounding Terminal	The grounding wire (used to ground the unit) attaches here.
6	IR Receiver (Extension)	This receives signals from the IR remote control through an IR extension, which can be purchased separately (see <i>Optional Equipment</i> , page 5).

IR Remote Control

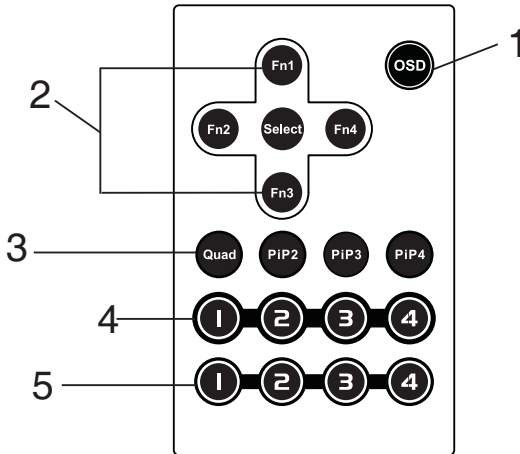

No.	Component	Description
1	OSD button	Press this to turn on/turn off the OSD menu. When the OSD menu is enabled, press the OSD button to go back to the previous menu/submenu.
2	Fn1 / Fn2 / Fn3 / Fn4 Buttons and Select Button	Use these buttons to switch between Function modes (Fn1 to Fn4), and to cycle through the OSD menu/selection. See <i>Fn Pushbuttons</i> , page 26 for details on how to store function mode settings, which you can invoke for later use. The Fn1~Fn4 buttons are positioned to correspond to the up / down / left / right direction. <ul style="list-style-type: none"> ◆ When cycling through the menu options, press the Select button to go the submenu. ◆ If you want to change or adjust a selection/value, press the Select button then the Fn1 (up) / Fn2 (left) / Fn3 (down) / Fn4 (right) buttons to go through all the selections/values. Press the Select button again to confirm a selection.
3	Display Mode buttons	Select the Display Mode you want to view. See <i>Display Modes</i> , page 20.
4	Port Selection Buttons 1~4	Press these buttons to switch ports (1~4).
5	Station Selection Buttons	If the CM1164 is daisy chained to one or several units (up to 4), press the button corresponding to the CM1164 device that you want to configure or operate.

Chapter 2

Hardware Setup



1. Important safety information regarding the placement of this device is provided on page 77. Please review it before proceeding.
2. Make sure that the power to all devices connected to the installation is turned off. You must unplug the power cords of any computers that have the Keyboard Power On function.

Rack Mounting

For convenience and flexibility, the CM1164 can be mounted on system racks. To rack mount a unit do the following:

1. Remove the screws attached to the unit as shown in the diagram below:

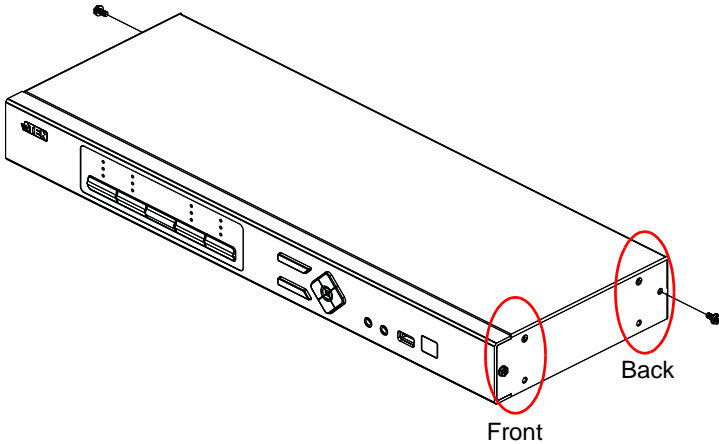

Note: You can remove the screws on the front side panels or the back side panels. The succeeding diagrams show the rack mounting steps for the back panel.

- Using the screws provided in the Mounting Kit (not included with this package), screw the mounting bracket into the side of the unit as show in the diagram below:

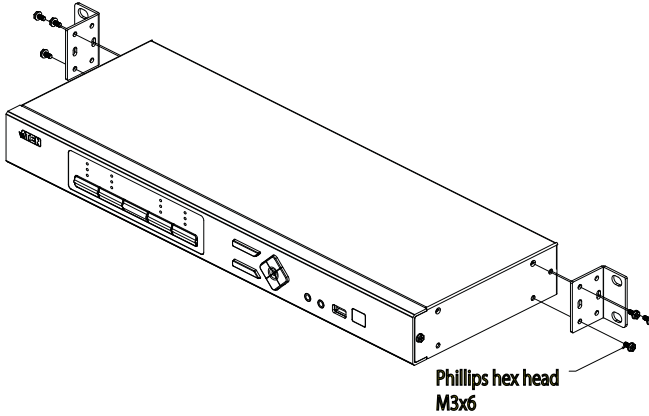

Note: The Mounting Kit is not included in the package. Please contact your dealer for more details.

- Screw the bracket into any convenient location on the rack.

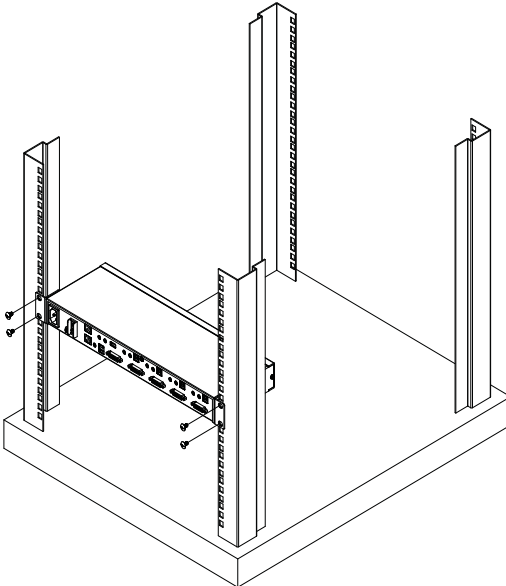

Note: These screws are not provided. We recommend that you use M5 x 12 Phillips Type I cross, recessed type screws.

Grounding

To prevent damage to your installation it is important that all devices are properly grounded.

1. Use a grounding wire to ground the CM1164 by connecting one end of the wire to the grounding terminal, and the other end of the wire to a suitable grounded object.
2. Make sure that the computer(s)/device(s) that the CM1164 connects to are properly grounded.

Note: The grounding wire is not included in the package. Please contact your dealer for the appropriate cable.

Single Station Installation

To set up your CM1164 installation, refer to the installation diagram on page 12 (the numbers in the diagrams correspond to the steps below), and do the following:

1. Plug your USB keyboard and USB mouse into the USB Console Ports located on the unit's rear panel.
2. Plug your DVI display into the Console DVI Single Link Port located on the unit's rear panel.
3. If you are using an IP phone headset or separate microphone and speakers, plug them into the analog audio ports on the unit's front panel. These audio ports have priority over those on the rear panel.
4. If you are using separate speakers and microphone, plug them into the console analog audio ports on the unit's rear panel.
5. Using the custom DVI KVM cable set, plug the DVI-D Single Link cable connector and the accompanying USB and audio connectors their corresponding sockets on the rear of the switch.
6. At the other end of the cable, plug the DVI and USB cables into their respective ports on the computer(s) that is(are) the source of DVI content.
7. Plug your USB peripherals into the type A sockets (one easy-access port is located on the front for portable devices; the second is located on the rear).
8. Plug the power cord into the CM1164 power jack, then plug the other end of the power cord into an AC power source.

9. Power on the displays and the computers/devices.

Note: The recommended power-on sequence is Port 1–Port 2–Port 3–Port 4.

Single Station Installation Diagram

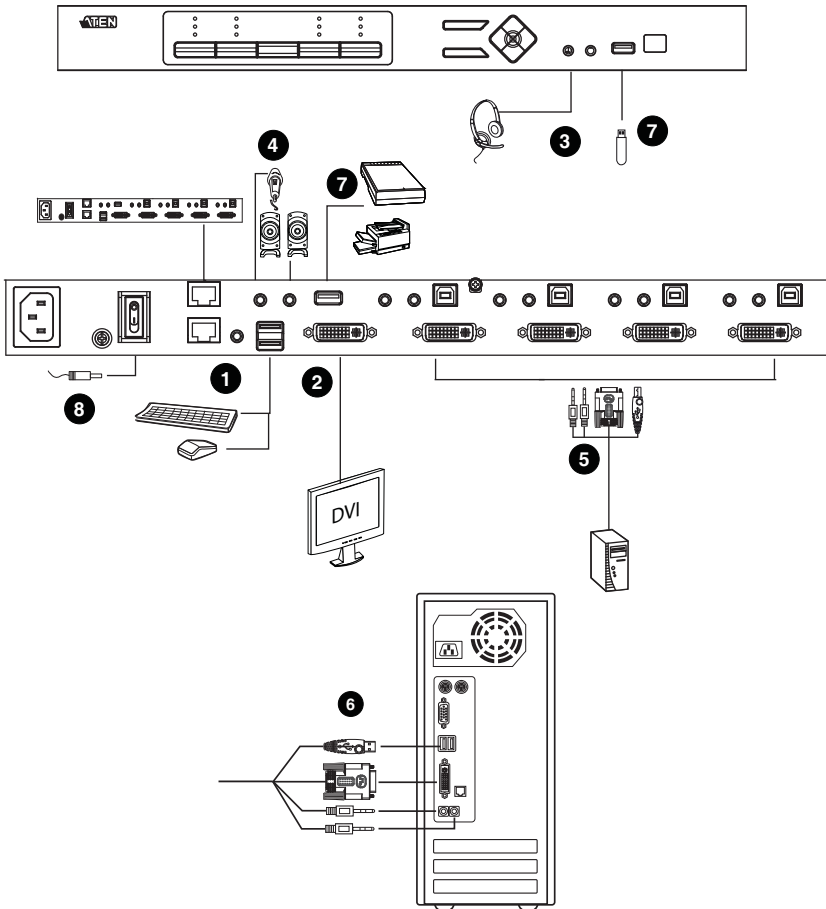

Daisy Chaining

To display even more computers/video source devices, up to 3 additional CM1164 units can be daisy chained from the original CM1164. As many as 16 computers/video source devices can be controlled from a single console in a complete daisy chain installation. Each CM1164 in a daisy chain requires its own monitor as the video signals cannot be passed through to other units on a daisy chain.

To set up a daisy chain installation, make sure that the power to all devices has been turned off, and do the following:

1. Use an RJ-45 cable to connect the *DCC Out* port of the parent CM1164 to the *DCC In* port of the child CM1164 unit(s) (first station out to second station in, second station out to third station in, etc.).
2. Plug a DVI display into the Console DVI Port located on each unit's rear panel.
3. Cable up the computer and the switch according to the information provided under *Single Station Installation*, page 11.
4. Repeat the above for any other switches you want to add to the chain (up to three).
5. Power up the installation: plug in the power cord for the first station, then power on each station on the installation in turn (second station, then third station, etc.). After all the stations are up, power on the computers/video source devices.
6. When switching to a computer only the keyboard and mouse signals are connected. To switch to a computer in a daisy chain see *DCC*, page 51.

Note: 1. The second, third and fourth units in a daisy chain will not be able to use the IR remote for control. Only the first (parent) CM1164 can use the IR remote for control.

2. You can copy the settings of the parent CM1164 to the child unit(s) with the **Clone** option (see *DCC Control*, page 60).
 3. Uncheck the **Enable** box in the DCC OSD menu of any child CM1164 unit to remove it from the daisy chain. This option is only available on child units. (see *DCC Control*, page 60).
-

Daisy Chain Installation Diagram

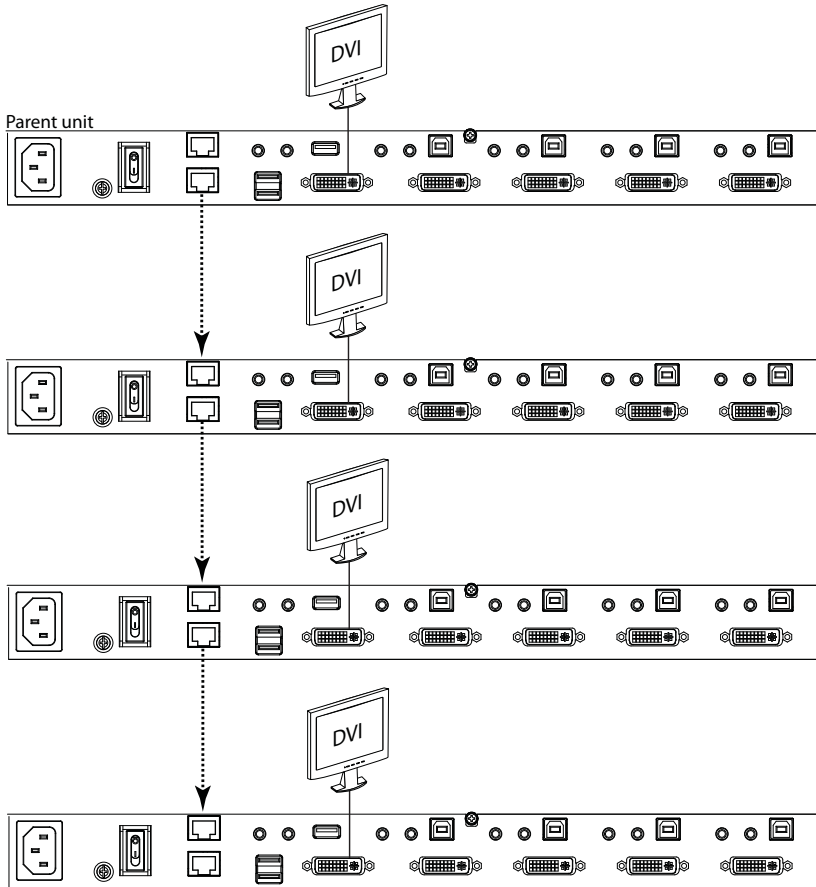

Chapter 3

Basic Operation

Overview

This chapter explains the basic components used to switch and display computers connected to the CM1164.

Port ID Number

Each computer connected to the CM1164 has a Port ID number. The number is assigned according to the port that it is connected to on the rear of the CM1164.

For example, a computer connected to port 1 is assigned Port ID 1. When you switch to a computer, the Port ID will appear at the top left corner of the screen to identify what computer you are working on, as shown below:

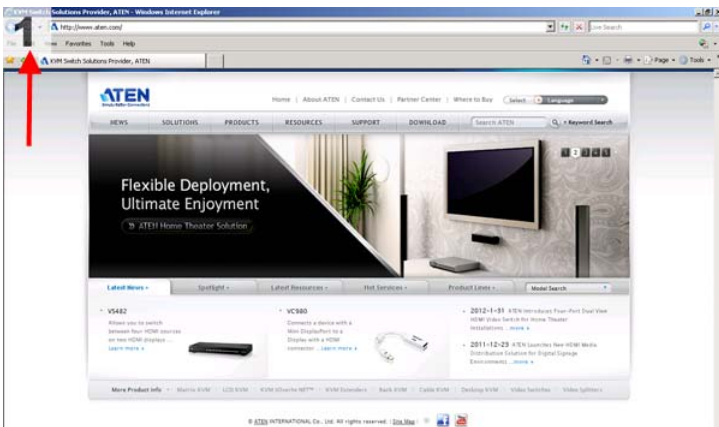

With *Display Modes* (page 20) you can view 2, 3 or 4 computers on the screen at the same time and each window will display the computer's Port ID. The Port ID number can be changed in the OSD menu, see *Port ID Display*, page 56.

Switching

When you switch to a computer, you switch to its three sources: **KVM** (keyboard, video, mouse), **Audio**, and **USB**. You can switch to these three sources independently, on different computers. This allows you to work on one computer (KVM), access the audio on another (Audio), and connect to peripheral devices on a third (USB).

Manual Switching

To manually switch use the **Port Selection** and **Mode** pushbuttons located on the front panel. The LEDs are explained on the next page.

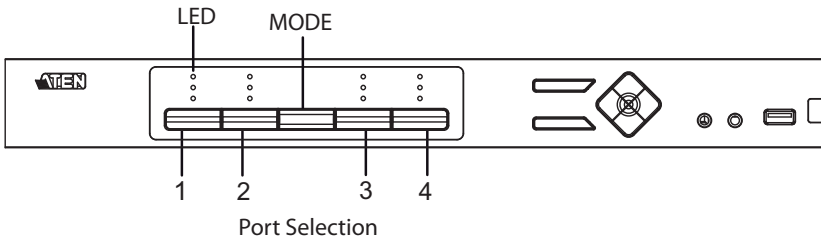



- ◆ To switch **KVM**, **Audio**, and **USB** access to a computer, press the *Port Selection* pushbutton of the computer you want to access.
- ◆ To switch **KVM** access to a computer, press **Mode** 2 times, and then press the *Port Selection* pushbutton of the computer.
- ◆ To switch **Audio** access to a computer, press **Mode** 3 times, and then press the *Port Selection* pushbutton of the computer.
- ◆ To switch **USB** access to a computer, press **Mode** 4 times, and then press the *Port Selection* pushbutton of the computer.
- ◆ Press *Port Selection* pushbuttons **1** and **2** – for 2 seconds to start **Auto Scan Mode***. See *Auto Scanning*, page 32.
- ◆ Press *Port Selection* pushbuttons **3** and **4** – for 2 seconds to execute a **KVM Reset**. See *KVM Reset*, page 27.

***Press and release either port selection pushbuttons to stop auto scan.**

LED Display

The front panel has three LEDs that represent the KVM, Audio and USB source. The LEDs light green or orange depending on which source is being accessed on what computer, as explained in the table.



LED		Indication
Icon	KVM 	<ul style="list-style-type: none"> ◆ Lights BRIGHT ORANGE to indicate KVM is selected. ◆ Flashes ORANGE to indicate that the computer is being accessed in Auto Scan Mode. ◆ All flash ORANGE to indicate the Firmware Upgrade has been invoked. ◆ The corresponding port LED of the USB keyboard/ mouse flashes when Keyboard Bypass is enabled. ◆ Lights a faint ORANGE to indicate that a computer is powered on
	Audio 	<ul style="list-style-type: none"> ◆ Lights BRIGHT GREEN to indicate Audio is selected. ◆ Flashes GREEN to indicate that Audio is selected on a computer in a Daisy Chain setup
	USB Link 	<ul style="list-style-type: none"> ◆ Lights BRIGHT GREEN to indicate USB is selected. ◆ Flashes GREEN to indicate that USB Link is selected on a computer in a Daisy Chain setup

Hotkey Switching

You can switch to a computer using hotkeys from the keyboard.

To switch to computer 1, do the following:

1. Press and hold down **[Num Lock]**.
2. Press and release **[-]**.
3. Release **[Num Lock]**.
4. Press **[1]**.
5. Press **[Enter]**.

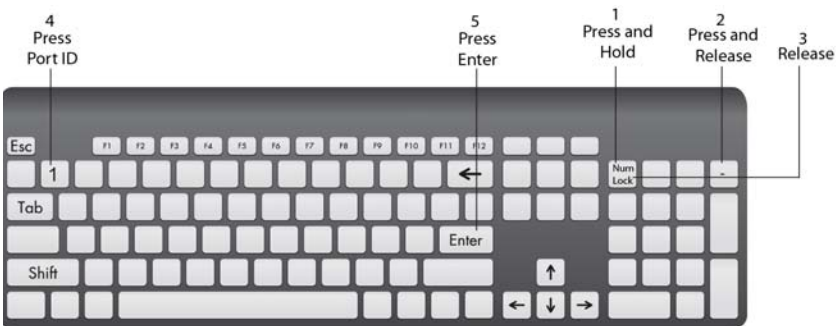

Repeat the steps using Port ID (1, 2, 3, 4) in step 4 to switch to the computer connected to that port. For more hotkeys, see *Hotkey Operation*, page 29.

Remote Switching

You can switch to a computer with the remote control. Point the remote at the CM1164 and press the *Port Selection* button of the computer you want to access.

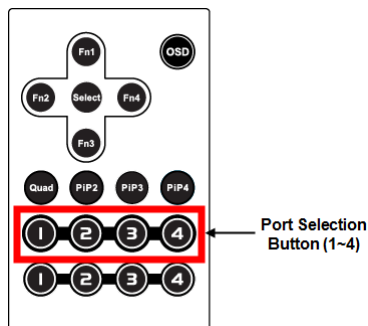

OSD Switching

You can switch to a computer using the OSD (On-screen Display) menu. The OSD is the CM1164's software that allows you to configure the CM1164. Use the mouse or keyboard (arrow keys) to move through the OSD.

To switch computers with the OSD, do the following:

1. Press the **OSD (ESC)** pushbutton on the front panel.

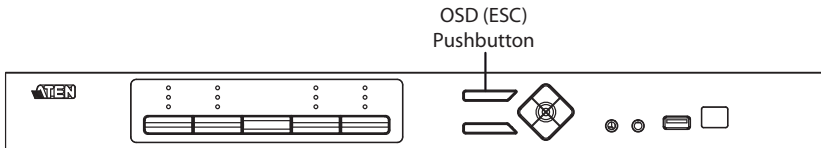

2. When the OSD menu appears, enter password: **000000** and click **Login**.



3. From the *Quick Menu*, use a **Port Selection** check box to select a computer: **1, 2, 3, or 4**.

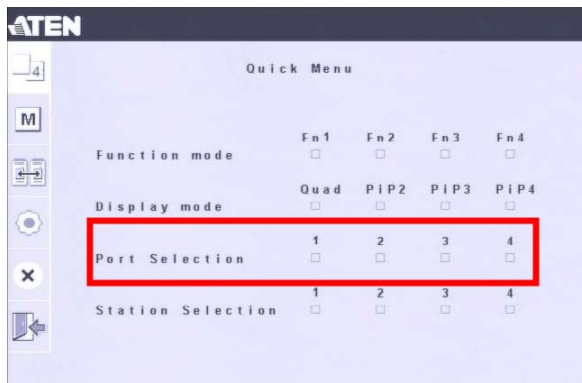

4. After checking a box, you will immediately switch to that computer.

Display Modes

The CM1164 has various Display Modes so that you can view multiple computers at one time on the same screen. Each computer is identified by the Port ID displayed at the top left corner, as shown below.

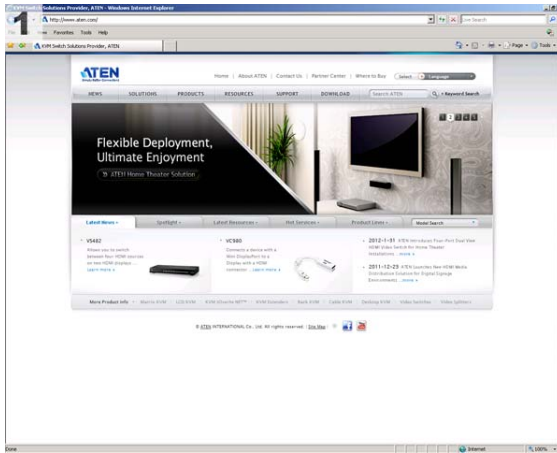

In the sections that follow a table is provided with the methods for switching display modes. To return to a normal full screen, like the one above, simply press a Port Selection pushbutton.

If you have a problem fitting the computer screens within a display mode window, see *Display Mode Resolutions*, page 25.

Quad View

Quad View displays four computers on the monitor in equal sized windows.





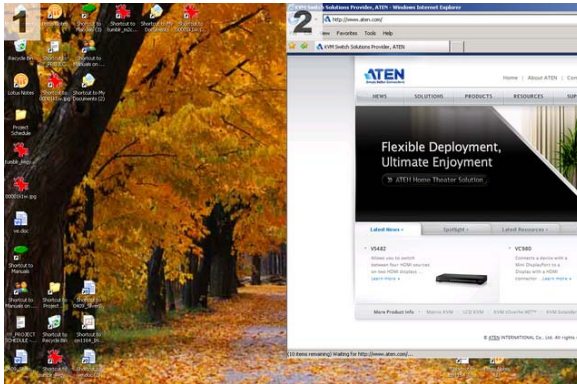

Method	Action	Description
Front Panel	Press Select to cycle through display modes.	
IR Remote Control	Press the Quad button.	
On-Screen Control Panel (<i>Hardware Cursor Mode must be enabled, see page 53</i>)	Press [Scroll Lock] x 2 Move mouse to top center of screen.	
Hotkey	See <i>Hotkey Setting Mode</i> , page 30 for hotkey instructions.	
OSD Menu	Open OSD → Display Modes: select Quad box.	

Picture in Picture - Dual

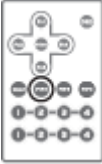
Dual View shows 2 computers on the monitor with one display overlapping.







Method	Action	Description
Front Panel	Press Select to cycle through display modes.	
IR Remote Control	Press the PIP2 button.	
On-Screen Control Panel (<i>Hardware Cursor Mode must be enabled, see page 53</i>)	Press [Scroll Lock] x 2 Move mouse to top center of screen.	
Hotkey	See <i>Hotkey Setting Mode</i> , page 30 for hotkey instructions.	
OSD Menu	Open OSD → Display Modes: select PIP2 box.	

Picture in Picture - Triple

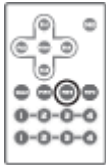
Triple view has 3 computers on the monitor with two displays overlapping.







Method	Action	Description
Front Panel	Press Select to cycle through display modes.	
Remote Control	Press the PIP3 button	
On-Screen Control Panel (<i>Hardware Cursor Mode must be enabled, see page 53</i>)	Press [Scroll Lock] x 2 Move mouse to top center of screen.	
Hotkey	See <i>Hotkey Setting Mode</i> , page 30 for hotkey instructions.	
OSD Menu	Open OSD → Display Modes: select PIP3 box.	

Picture in Picture - Quad

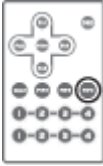
Quad view has 4 computers on the monitor with three displays overlapping.



Method	Action	Description
Front Panel	Press Select to cycle through display modes.	
Remote Control	Press the Pip4 button	
On-Screen Control Panel (<i>Hardware Cursor Mode must be enabled, see page 53</i>)	Press [Scroll Lock] x 2 Move mouse to top center of screen.	
Hotkey	See <i>Hotkey Setting Mode</i> , page 30 for hotkey instructions.	
OSD Menu	Open OSD → Display Modes: select PIP4 box.	

Display Mode Resolutions

Fitting Resolutions

For all Display Modes, when the computer's resolution does not fit the set resolution, a black space fills the gap, as shown below.

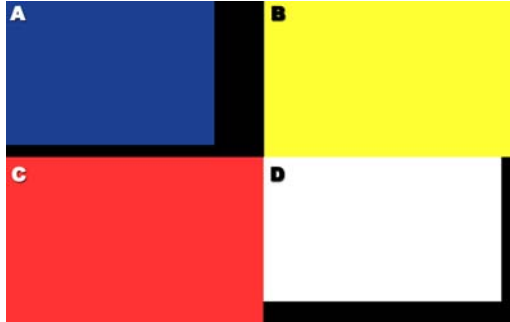

In the example above, the computers connected to A and D are smaller than the resolution configured for the Display Mode. The resolution can be set via the OSD (see *Quadview Resolution*, page 49) to get the best fit.

Fitting Picture in Picture

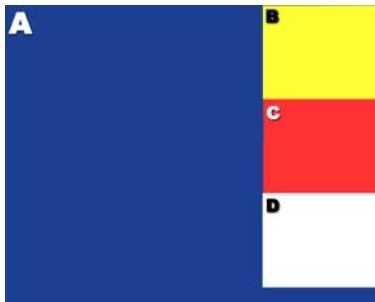

There is an option to view computer A in full so that B, C, and D do not cover the right side of the screen and instead show in a smaller resolution that allows all the computers to fit into the display without overlapping. See *Picture in Picture (Dual / Triple / Quad)*, page 47 for details.

Fn Pushbuttons

You can save the current Display Mode and KVM/Audio/USB focus into a front panel (Fn) pushbutton. With (Fn) pushbuttons, you can easily toggle between 4 different configurations, saving you time. To save a configuration see *Fn Key*, page 64. Use the table below to switch to a saved (**Fn**) configuration.

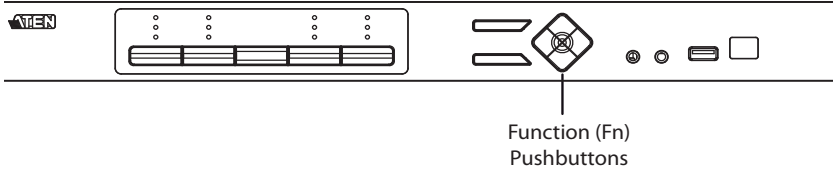

Method	Action	Description
Front Panel Pushbutton	Press the Fn1 , Fn2 , Fn3 , or Fn4 pushbutton.	
Remote Control	Press the Fn1 , Fn2 , Fn3 , or Fn4 button.	
On-Screen Control Panel (<i>Hardware Cursor Mode must be enabled, see page 53</i>)	Press [Scroll Lock] x 2 Move mouse to top center of screen. Select function button.	
Hotkey	See <i>Hotkey Setting Mode</i> , page 30 for hotkey instructions.	
OSD Menu	Open OSD → Function Mode: select Fn1 , Fn2 , Fn3 , or Fn4 .	

Powering Off and Restarting

If it becomes necessary to power off the unit, before starting it back up you must do the following:

1. Shut down all the computers that are attached to the switch.
2. Unplug the switch's power adapter cable.
3. Wait 10 seconds, then plug the switch's power adapter cable back in.
4. After the switch is up, Power On the computers.

KVM Reset

To reset your complete KVM installation to the factory default settings, use the OSD menu. See *Restore Default Values*, page 66.

This Page Intentionally Left Blank

Chapter 4

Hotkey Operation

The CM1164 provides easy-to-use hotkeys to control and configure your KVM installation from the keyboard.

Activate the OSD

To activate the OSD using your keyboard, tap the **Scroll Lock** key twice:

[Scroll Lock] [Scroll Lock]

You can close the OSD by pressing [**Esc**] or **Spacebar**.

- ◆ [**Esc**] returns to the previous page.
- ◆ **Spacebar** immediately exits the OSD.

Note: The hotkey to activate the OSD can be change to the **Ctrl** key. See *OSD Hotkey*, page 54 for details.

Activate the OSD in Hardware Cursor Mode

The following applies when the Hardware Cursor Mode is enabled (See *Hardware Cursor Mode*, page 53).

To open the OSD:

1. Press [Scroll Lock] [Scroll Lock] then mouse right-click; or press [Scroll Lock] [Scroll Lock] [Scroll Lock].
2. Click Esc to close the OSD and go back to normal PC operation.

Note: When Hardware Cursor Mode is **disabled**, pressing [Scroll Lock] twice opens the OSD.

Hotkey Setting Mode

Hotkey Setting Mode is used to configure your CM1164 with hotkeys. All hotkey operations begin with invoking Hotkey Setting Mode (HSM) – then hotkeys can be used to make changes.

Invoking HSM

To invoke HSM do the following:

1. Press and hold down [**Num Lock**].
2. Press and release [-].
3. Release [**Num Lock**].

Note: The keys for invoking HSM can be change. See *Hotkey Selection Mode*, page 54 for details.

When HSM is active, the Caps Lock, and Scroll Lock LEDs flash in succession to indicate that HSM is in effect. They stop flashing when you exit HSM.

Ordinary keyboard and mouse functions are suspended – only Hotkey keystrokes can be input.

At the conclusion of some hotkeys, you automatically exit HSM. With other operations, you must manually exit HSM. To exit HSM manually, press [**Esc**] or **Spacebar**.

The table below describes the actions of each hotkey. First invoke HSM then enter the hotkey.

Hotkey	Action
[A]	Starts Auto Scan. See <i>Auto Scanning</i> , page 32 for more information.
[Enter]	Switch to the next computer. (1 to 2, 2 to 3, 3 to 4, and 4 to 1.)
[Port ID] [Enter]	Switch to the computer device that corresponds to the Port ID (1, 2, 3, or 4) entered.
[Port ID] [K] [Enter]	Brings only the KVM focus from the port that currently has it to the computer that corresponds to the Port ID entered. The USB and audio focus do not change.

Hotkey	Action
[Port ID] [U] [Enter]	Brings only the USB hub focus from the port that currently has it to the computer that corresponds to the Port ID entered. The KVM and audio focus do not change.
[Port ID] [S] [Enter]	Brings only the audio focus from the port that currently has it to the computer that corresponds to the Port ID entered. The KVM and USB hub focus do not change.
[Station ID] [Port ID] [K] [Enter]	Brings only the KVM focus to the computer that corresponds to the Port ID entered, on the CM1164 that corresponds to the Station ID entered, when a daisy chain is setup. See <i>Daisy Chaining</i> , page 13.
[D]	Implements Video DynaSync to eliminate boot-up display problems and optimize resolutions when switching between ports. See <i>Video DynaSync</i> , page 34.
[F4]	Lists the KVM's current settings. See <i>Press the port number [1], [2], [3], or [4] and [Enter].</i> , page 34.
[F5]	If any USB devices lose focus or connectivity, a USB reset may solve the issue. See <i>USB Reset</i> , page 34.

Auto Scanning

The Auto Scan feature automatically cycles the KVM focus through the computer ports at regular intervals. This allows you to monitor the computer activity without having to switch from port to port manually. Although the video focus switches from port to port, the keyboard, mouse, and USB focus do not switch. They stay with the port they were on when Auto Scanning started.

The table below describes the actions of each hotkey. First invoke HSM then enter the hotkey.

Hotkey	Action
[A] [Enter]	Invokes Auto Scan. The KVM focus cycles from port to port at 5 second intervals . This is the Default setting.
[A] [n] [Enter]	The KVM focus cycles from port to port at n second intervals. Note: The n stands for the number of seconds that the CM1164 should dwell on a port before moving on to the next. Replace the n with a number between 1 and 99 when entering this hotkey combination.

While Auto Scan Mode is in effect, ordinary keyboard and mouse functions are suspended – only Auto Scan Mode keystrokes and mouse clicks can be input. You must exit Auto Scan Mode in order to regain normal control of the console.

Auto Scanning - Display Modes

Auto scan can be invoked with Full Screen, PiP Dual and PiP Triple modes. To use auto scan with PiP Triple enable **Scan** for a channel within the OSD menu (see *Configuring Display Modes*, page 48). When you start auto scan with PiP Dual or PiP Triple one of the secondary windows (channels) is used to auto scan two or three computers.

Auto Scan mode does not work with **Quad View** or **PiP Quad** as these modes already display all computers on the screen. (see *Display Modes*, page 20).

Display Mode

Use the Display Mode hotkeys to switch between the different display modes. For more information on display modes, See *Display Modes*, page 20.

The table below describes the actions of each hotkey. First invoke HSM then enter the hotkey.

Hotkey	Action
[P] [1] [Enter]	Starts the Quad View display mode. See <i>Quad View</i> , page 21.
[P] [2] [Enter]	Starts the PiP Dual display mode. See <i>Picture in Picture - Dual</i> , page 22.
[P] [3] [Enter]	Starts the PiP Triple display mode. See <i>Picture in Picture - Triple</i> , page 23.
[P] [4] [Enter]	Starts the PiP Quad display mode. See <i>Picture in Picture - Quad</i> , page 24.

To return to the normal single computer display mode, switch to a computer by invoking HSM and use the hotkey [Port ID] [Enter].

Fn Key

Use the Fn hotkeys to implement the configuration of a function key. For more information on Fn keys, See *Fn Pushbuttons*, page 26.

The table below describes the actions of each hotkey. First invoke HSM then enter the hotkey.

Hotkey	Action
[F] [1] [Enter]	Implements the Fn1 key configuration. See <i>Fn Key</i> , page 64.
[F] [2] [Enter]	Implements the Fn2 key configuration. See <i>Fn Key</i> , page 64.
[F] [3] [Enter]	Implements the Fn3 key configuration. See <i>Fn Key</i> , page 64.
[F] [4] [Enter]	Implements the Fn4 key configuration. See <i>Fn Key</i> , page 64.

Hotkey Steps

List Current KVM Settings

To see a listing of the current switch settings, do the following:

1. Open a text editor or word processor and place the cursor in the page window.
2. Invoke HSM (see page 30).
3. Press and release [**F4**] to display the settings.

USB Reset

If the USB loses focus and needs to be reset, do the following:

1. Invoke HSM (see page 30).
2. Press and release [**F5**]

Video DynaSync

Video DynaSync is ATEN's exclusive technology that eliminates boot-up display problems and optimizes resolution when switching between ports. To invoke Video DynaSync, do the following:

1. Invoke HSM (see page 30)
2. Press [**D**]

Note: When the monitor is disconnected and reconnected, the CM1164 executes Video DynaSync one more time.

Port Switching

To switch to another computer, do the following:

1. Invoke HSM (see page 30).
2. Press the port number [**1**], [**2**], [**3**], or [**4**] and [**Enter**].

Chapter 5

Channel Editor

Overview

This chapter explains how to use the *Channel Editor Mode*. The Channel Editor The Channel Editor provides an easy way to edit windows and other functions with the mouse and on-screen control panel.

Starting the Channel Editor

When the Channel Editor Mode is triggered, you use the mouse and an on-screen control panel to make changes as you view computers. The Channel Editor must be triggered before each change.

The Hardware Cursor Mode must be enabled or the Channel Editor will not start (see *Hardware Cursor Mode*, page 53). To trigger the Channel Editor, use one of two actions:

- ♦ **Keyboard:** Press [Scroll Lock] x 2.
- ♦ **Mouse:** Press and hold the mouse wheel for 3+ seconds. Mouse Wheel Mode must be enabled (see page 53).

When the Channel Editor is triggered, the Port ID of each window will be displayed and a second mouse cursor will appear.

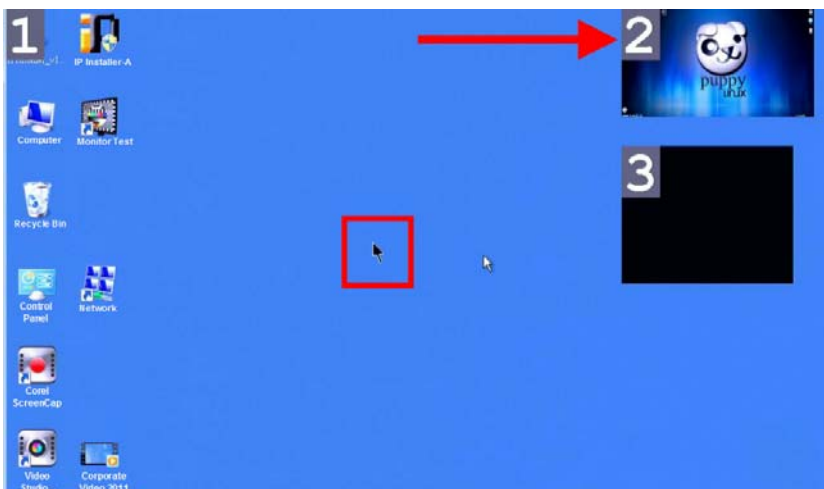

Channel Editor Mouse

When the Channel Editor is started a new cursor appears and the mouse no longer works on the PC. Instead the mouse is used for Channel Editor functions to Switch computers; move, swap or resize windows; and open the OSD menu.

The table below explains how the mouse works with Channel Editor triggered.

Description	Action	Result
Switch Ports	Single click in a window	Brings KVM focus to the computer clicked
	Double click in a window	Brings full screen KVM focus to the computer clicked
OSD Menu	Right click on the screen; or press [Scroll Lock] x 3	Opens the OSD menu
Move Window	Click and hold a Port ID to drag the window	Allows you to move a window to a different position on the screen
Resize Window	Double click the Port ID	Each double click resizes the window, choose from 3 different sizes
Full Screen - View Only	Triple click the Port ID	Brings full screen view only mode to the computer with the port ID that was clicked Single click exits to the previous view
Swap Windows	Click the Port ID, then click the Port ID of another window	Swaps the computer in window 1 with the computer in window 2

-
- Note:** 1. Some functions only work with Picture in Picture (PiP) mode, such as moving a windows position or resizing a window.
2. The mouse icon changes color (black or white) when Window Editor is enabled. To change this see **Cursor Type, Hardware Cursor Mode**, page 53.
-

- ◆ **Move Window:** Click and hold any **Port ID**, then drag the window across the screen to a new position.

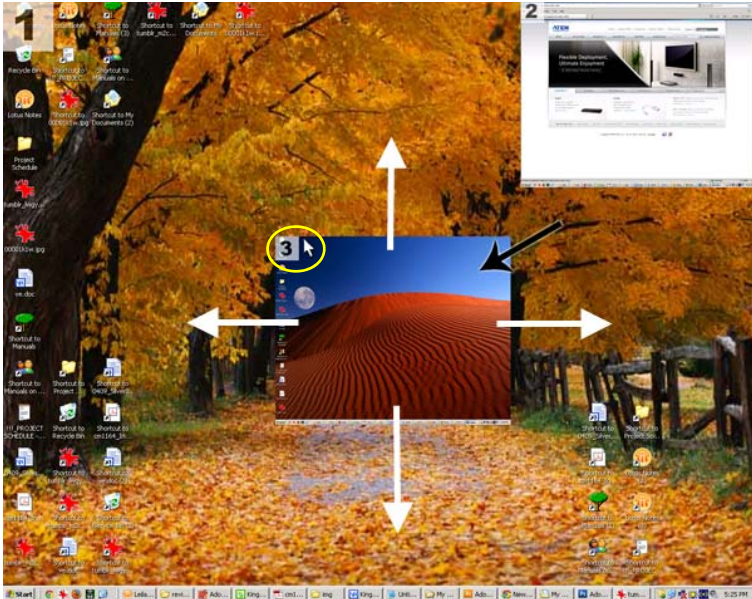

- ◆ **Resize Window:** Double click any **Port ID** to change the window size.

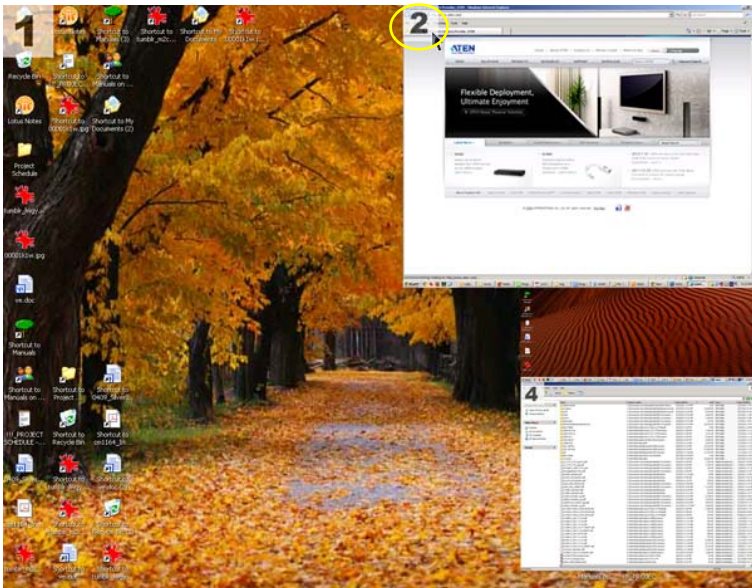

- ♦ **Swap Windows:** Click the **Port ID** of a window, then click the second **Port ID** – the two computers will switch windows.

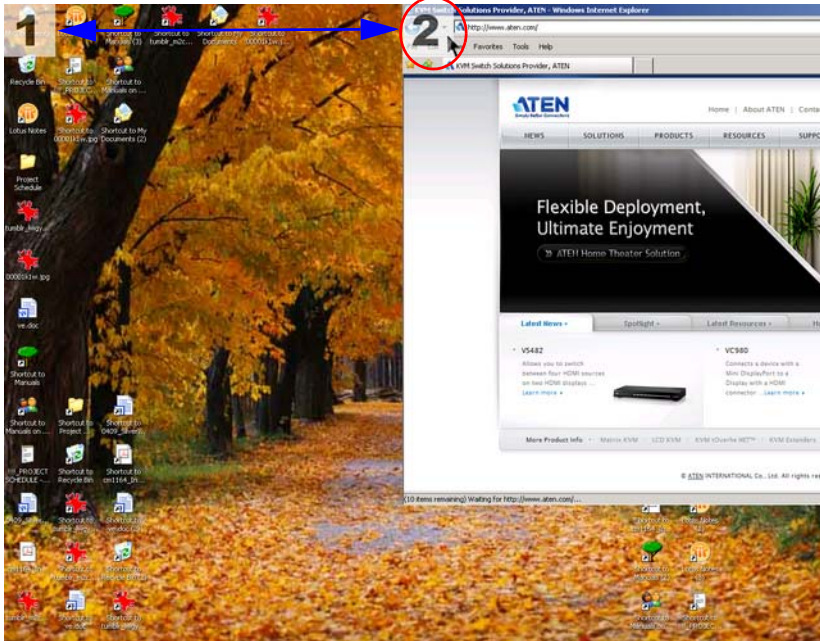

Channel Editor Control Panel

The Channel Editor has an on-screen control panel that provides an easy way to change Display Modes, use Fn keys and open the OSD menu. To use the control panel, trigger the Channel Editor by pressing [**Scroll Lock**] x 2 and move the mouse to the top center of the screen. The control panel appears at the top of the screen, as shown below:



The control panel has buttons for the function (Fn) keys, Display Modes and to open the OSD menu.







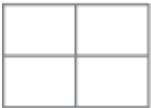
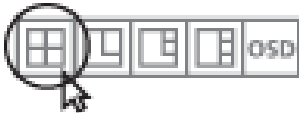

Click the control panel buttons to select an option:

- ◆ **Fn1~Fn4:** Click a function button to implement its display mode and KVM settings. To save an Fn key configuration, see *Fn Key*, page 64.
- ◆ **OSD:** Click the OSD button to open the OSD menu.
- ◆ **Display Modes:** Use these four buttons to switch display modes, as described in the table on the next page. For detailed information on display modes, see *Display Modes*, page 20.

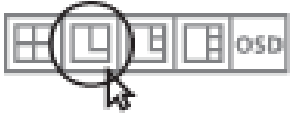
Display Modes

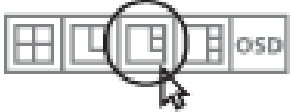
Use the control panel to select a Display Mode:

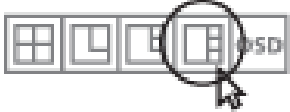
Display Mode	Button
<p>Quad-View</p> 	 <p>Quad View displays four computers on the monitor in equal sized windows.</p>
<p>PIP Dual</p> 	 <p>Dual View shows 2 computers on the monitor with one display overlapping.</p>
<p>PIP Triple</p> 	 <p>Triple view has 3 computers on the monitor with two displays overlapping.</p>
<p>PIP Quad</p> 	 <p>Quad view has 4 computers on the monitor with three displays overlapping.</p>

Chapter 6

OSD Operation

Overview

The On-Screen Display (OSD) is a menu driven interface for settings and switching operations. There are three ways to display the OSD:

- ◆ Press the OSD front panel pushbutton
- ◆ Press the OSD button on the IR remote control
- ◆ Tap [Scroll Lock] twice on the console keyboard

The OSD incorporates a four level (administrator / power user / user / guest) password system. Before the OSD Main Screen displays, a login dialog box appears that asks for a password.

The first time you login, only the **Guest** account is enabled. Enter the Guest password: **00000** in order to access the OSD Main Screen.



The **Guest** password has full access rights and is meant for first time setup.

To enable use of the Administrator, Power User, and User accounts, go to the *Settings* → *System* → *Security* menu and check **Enable** (See *Security*, page 58). When Security is enabled, the Guest account is disabled and can't be used. When the **Enable** box is *unchecked* only the Guest account can be used to log in.

Account passwords are provided on the next page.

The default passwords are as follows:

- ♦ **Administrator** - 111111
- ♦ **Power User** - 222222
- ♦ **User** - 333333
- ♦ **Guest** - 000000



These passwords can be changed in the *Security* page (see page 58), except for the **Guest** account. When Security is enabled, the **Guest** account will be disabled automatically to secure the CM1164.





OSD Operation and Menu



There are three ways to cycle through the OSD menu, go to submenus, change/adjust the options and make a selection, as follows:

- ◆ **Front panel pushbuttons** – Use the **Fn1~Fn4**, **Select** and **OSD** pushbuttons located on the front panel. The **Fn1~Fn4** buttons correspond to up / down / left / right directions. Use **Select** to enter an option and **OSD** to exit a menu. See *Front View*, page 6.
- ◆ **IR remote control** – See *IR Remote Control*, page 8.
- ◆ **Keyboard** – Use the **Arrow** keys to move through the menus, the **Enter** key to select and save options, and the **Esc** key to exit.
- ◆ **Mouse** – Point and click **Once** to enter menu pages and click **Twice** to select, change and save options, or enter sub-menu pages.

The OSD menu options are shown in the table below. The highlighted texts indicate the CM1164's default setting.

Menu Page	Sub-Menu Page(s)	
Login Page		
Port Selection 	Sets a Function Mode, Display Mode, or switches with Port Selection and Station Selection.	See <i>Port Selection</i> , page 45.
Mode 	Quadview	See <i>Quadview</i> , page 46.
	PiP Dual	See <i>Picture in Picture (Dual / Triple / Quad)</i> , page 47.
	PiP Triple	
	PiP Quad	
	Disable Channel	See <i>Disable Channel</i> , page 48
	Quadview Resolution	See <i>Quadview Resolution</i> , page 49.
	Startup Display Mode	See <i>Startup Display Mode</i> , page 50
DCC 	Select the Station and Port to switch keyboard and mouse control to in a DCC installation.	See <i>DCC</i> , page 51

Menu Page	Sub-Menu Page(s)			
Setting 	System 	Hardware Cursor Mode	Enable / Disable Channel Wheel Mode Cursor Type	
		OSD Hotkey	Scroll Lock / Ctrl	
		Hotkey Selection Mode	[Num Lock] + [-] / [Ctrl] + [F12]	
		Video DynaSync	Enable / Reload / Default KVM EDID	
		Activate Beeper	Enable / Disable	
		Port ID Display	Port / Duration	
		OSD Language	English / German / French / Japanese / Traditional Chinese	
		Keyboard Language	French / English / Japanese	
		Auto Scan	Scan Duration / Scan Mode	
		Security	Enable	
			User Password	Password
			Power User Password	Password
			Admin User Password	Password
			Login Timeout	1 to 99 minutes
			RS232 Remote Login	Enable/Disable
			Auto Login Enable	Enable/ Disable
	KVM Status	Read only information		
	DCC Control	Enable / Clone		
	Computer 	Keyboard Emulation	Enable / Disable	
		Mouse Emulation	Enable / Mouse Switching Function	
		Power On Detection	Enable / Disable	
		Set OS	Auto-Detect / MAC / Sun / SPC	
		USB Reset	Enable / Disable	
	Configuration 	Fn Key	Edit	
			Selection	
		Restore Default Values	Enable / Disable	
		Firmware Upgrade	Enable / Disable	
OSD Config Backup Restore	Backup Restore in progress			
Help 	Hotkey List	Read only information		
	Info	Read only information		

Menu Page	Sub-Menu Page(s)
Close 	Click this to close the active page.
Exit OSD 	Click this to log out of the OSD menu.

Port Selection

Use the Quick Menu to select a function or mode. After checking a box the option that is selected takes effect immediately.

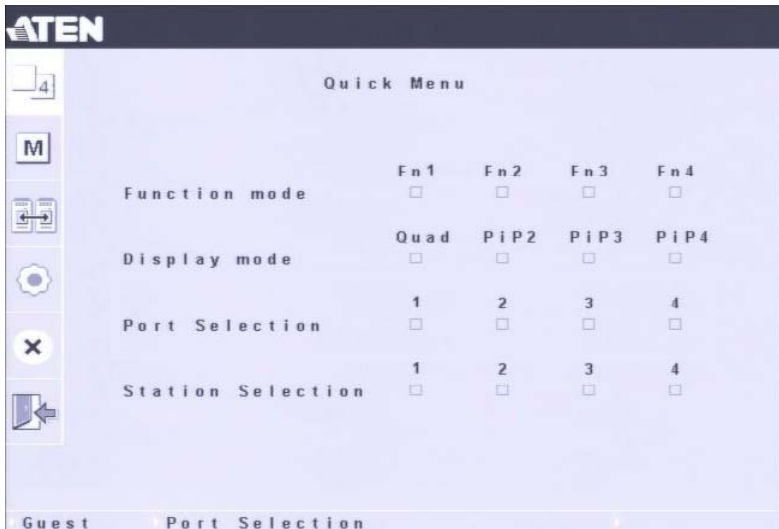

- ◆ **Function Mode.** Select a function (Fn) button to implement.
- ◆ **Display Mode.** Select a Display Mode to implement.
- ◆ **Port Selection.** Switches KVM, Audio, and USB focus to the computer connected to the selected port.
- ◆ **Station Selection.** Selects the Station when you have multiple CM1164's setup in a daisy chain. Select a *Station*, then select a *Port Selection* for the keyboard and mouse (no video) to be switched to that computer. See *Daisy Chaining*, page 13.

Mode Selection

Click the *Mode* icon to configure the Display Modes, Channels, Quadview Resolution, or Startup Display Mode. See *Display Modes*, page 20 for information on display modes, or *Channel ID*, page 71 for information on channels.



Display Modes

Select a Display Mode to configure which computer corresponds to each channel window. See *Channel ID*, page 71 for information on channels.

Quadview

Quadview lets you show all four computers/video sources on the display at one time. Use the port number that corresponds to a computer and check a channel window **A**, **B**, **C**, or **D** for it to display in, then click **Save**.

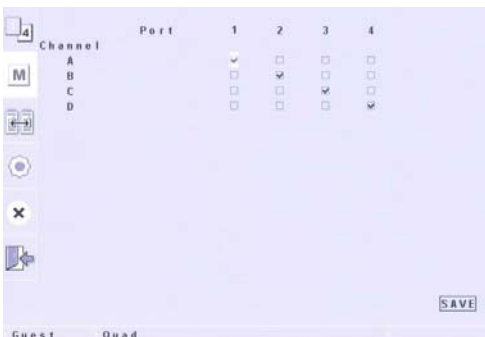

Picture in Picture (Dual / Triple / Quad)

The *Picture in Picture (PiP) Mode* lets you show two (*Dual*), three (*Triple*) or four (*Quad*) computers on the display at one time in separate windows (see *Display Modes*, page 20).

PiP Dual Mode

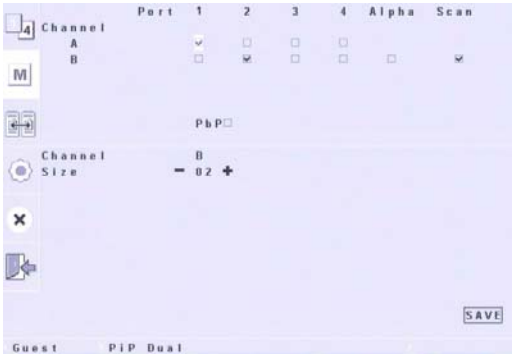

PiP Triple Mode

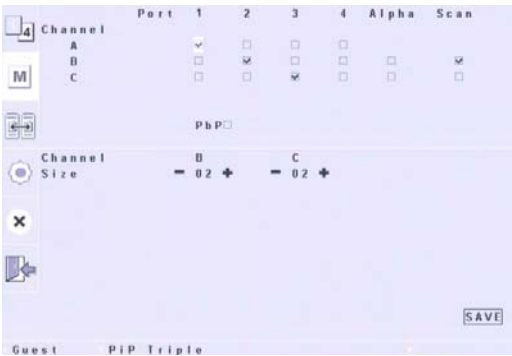

PiP Quad Mode

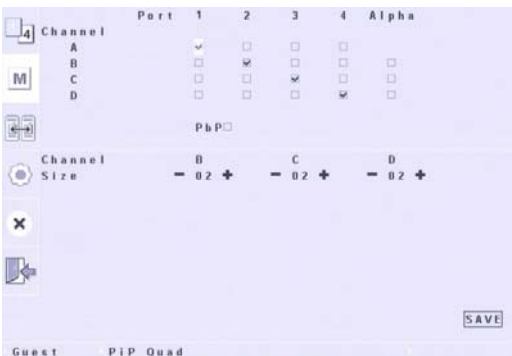

Configuring Display Modes

To configure the *PiP* (*Dual / Triple / Quad*) screens, do the following steps:

1. Use the port number that corresponds to a computer and check the channel window (A, B, C, or D) for it to display in.
2. **Alpha.** Checking this option affects the transparency for the port's display on-screen, enabling you adjust it.
3. **PbP.** In *Picture in Picture* mode, Channel A takes up the whole screen while the rest of the channels are placed on the right side of the display, partially blocking Channel A's desktop.

In order to view Channel A without the other Channels overlapping it, check **PbP** (Picture by Picture). This shows Channel A in full, in a smaller resolution that allows all the channels to fit into the display without overlapping.

For PiP Triple Mode, use the **Scan** check box to select the channel for Auto Scanning. The channel selected will auto scan between two computers when PiP Triple is in use and auto scan is invoked. See *Auto Scanning - Display Modes*, page 32, for details.

4. **Channel Size.** Use the (-) and (+) to change a channel's size. You can choose a value from 1 to 3 (maximum size).

Disable Channel

Check a port number that you do not want to show on the screen. The corresponding channel window for that port number will not appear. See *Channel ID*, page 71 for information on channels.

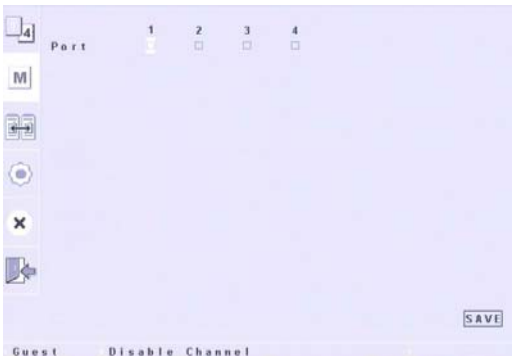

Quadview Resolution

In *Quad* Mode, the maximum video resolution is the resolution of the source device connected to Channel A. All the channels are set to this resolution, which may cause poor video quality if the resolution is smaller than that of the source device.



Select the video resolution that best fits the display.

1280 x 720	1600 x 1200
1280 x 960	1680 x 1050
1280 x 1024	1920 x 1200
1360 x 768	1920 x 1080
1440 x 900	

The size of each of the channels adjusts accordingly. For example, selecting 1600 x 1200 results in display windows measuring 800 x 600.

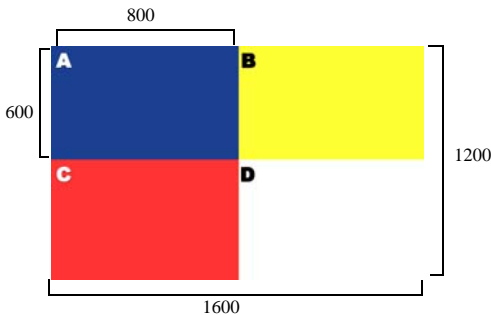

If the resolution does not match the channel's video resolution, it is adjusted to fit accordingly and black spaces may fill the gaps.

Startup Display Mode

The *Startup Display Mode* allows you to set the default display mode to use when the CM1164 is powered on. By default only the full screen option is available. For other options to appear – disable Power on Detection (see *Power On Detection*, page 62).



Check the default display mode to use and click **Save** to apply the change.

DCC

Up to four units can be daisy chained in one installation and users can switch the keyboard and mouse between up to 16 computers. In DCC when you switch to a computer on a different station only the keyboard and mouse control is switched. The video display will not change as the video can not be passed across two CM1164's. Connect a display to each CM1164 in a daisy chain.

Use the DDC screen to select a *Station* on the daisy chain and the *Port* number of the computer to connect to, then click **Select**.



Note: Only stations in the daisy chain are shown on the screen – if there are only two units in the chain, stations 3 and 4 are grayed out.

System Setting

The *Systems Setting* section is used to configure the CM1164 and is divided into four main sections: *System*, *Computer*, *Configuration* and *Help*.

System

Use the *System* page to configure settings related KVM control.

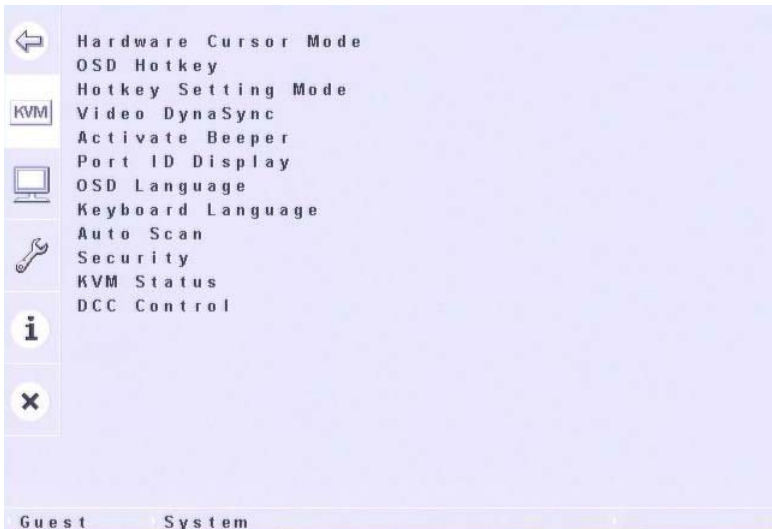

Hardware Cursor Mode

The *Hardware Cursor Mode* allows use of the Channel Editor. The Channel Editor provides a way to change display modes and other settings with the mouse and an on-screen control panel. For details on how to use the Channel Editor, see *Channel Editor*, page 35.

Mouse Emulation must be enabled for Hardware Cursor Mode to work (see *Mouse Emulation*, page 62).

When *Hardware Cursor Mode* is enabled, you must press [Scroll Lock] 3 times to enter the OSD menu.

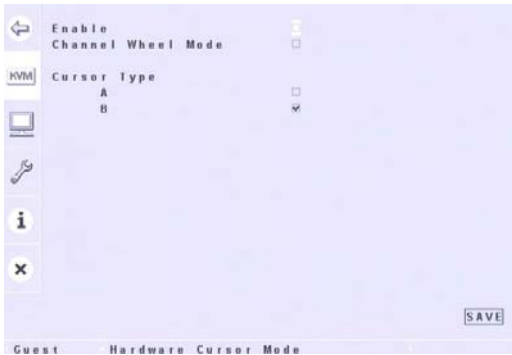

- ◆ **Enable.** Allows the Channel Editor functions to work.
- ◆ **Channel Wheel Mode.** Starts the Channel Editor by holding down the mouse wheel for 3+ seconds.
- ◆ **Cursor Type.** Check **A** for a white mouse cursor, or **B** for a black mouse cursor for when the Channel Editor or OSD menu is triggered. This can help you know when you are in normal PC mode or Channel Editor/OSD mode.
- ◆ Click **Save** to apply the settings.

OSD Hotkey

If using the *Scroll Lock* key to open the OSD menu conflicts with other programs running on the computer, the *Ctrl* key can be used instead. Check which hotkey you want to use to open the OSD and click **Select**.



Hotkey Selection Mode

You can switch between two hotkey combinations to invoke HSM (see *Hotkey Setting Mode*, page 30).



- ◆ **Enable**. Allows use of the HSM hotkey.
- ◆ **[Num Lock] + [-]**. Sets the two keys shown to invoke HSM.
- ◆ **[Ctrl] + [F12]**. Sets the two keys shown to invoke HSM.

Video DynaSync

Extended Display Identification Information (EDID) is a data format that contains a display's basic information and is used to communicate with the video source/system. The Video DynaSync feature allows devices to store a console monitor's EDID so that boot-up display problems are eliminated.



- ◆ **Enable.** To use the *Video Dynasync* features.
- ◆ **Reload.** To check and store the EDID of a console monitor at each startup.
- ◆ **Default KVM EDID.** The CM1164 implements the EDID of all connected displays and use the best resolution for all displays.
- ◆ Click **Save** to apply the settings.

Activate Beeper

Check **Enable** to have the CM1164 sound a beep to indicate and confirm when configuration changes made. Click **Save** to apply the setting.

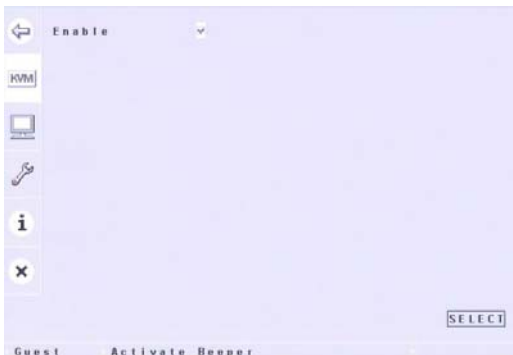

Port ID Display

You can assign a different Port ID to display for a computer, instead of using the default Port ID's of each physical port. This is useful when daisy chaining two or more CM1164s.

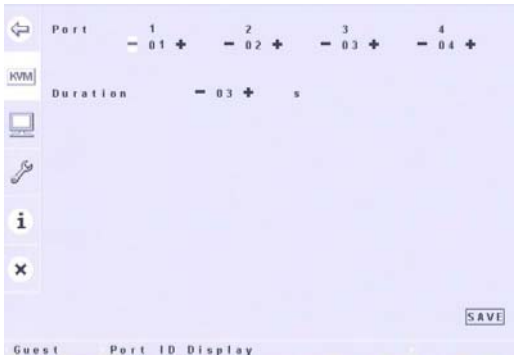

- ◆ **Port.** Use (-) and (+) to select a Port ID for a port. You can assign any number between 1 and 99.
- ◆ **Duration.** Use (-) and (+) to set how long in seconds the Port ID is displayed on screen before disappearing. You can assign any number between 1 and 99.
- ◆ Click **Save** to apply the settings.

OSD Language

Select the language for the OSD menus. Available languages are: *English*, *German*, *French*, *Japanese* and *Traditional Chinese*. Click **Select** to apply the setting.

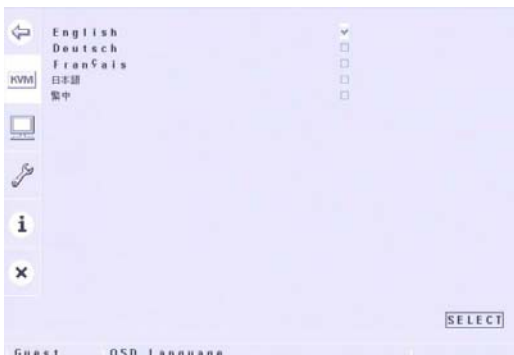

Keyboard Language

Select the language that the console keyboard is set to. The choices are: *English*, *French* and *Japanese*. For these options to be available you must enable keyboard emulation (see page 61). Keyboard language options are not available in DCC installations. Click **Select** to apply the settings.



Auto Scan

The Auto Scan feature enables the CM1164 to cycle from port to port at certain time intervals. This gives users an automated way of viewing all the computers connected to the ports.

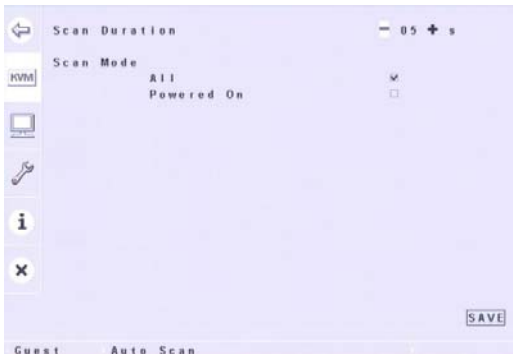

- ◆ **Scan Duration.** Select how many seconds a port has KVM focus before the focus switches to the next port. Use (-) and (+) to assign any number between 1 and 99.
- ◆ **Scan Mode.** Set whether all ports are included in the scan check **All** for all computers; or check **Powered On** to scan only powered on computers.
- ◆ Click **Save** to apply the settings.

Security

You can enable and change passwords for the *User*, *Power User* and *Administrator* accounts for logging in to the OSD. Click **Save** to apply. For the default account passwords, see page 34.



Note: For a complete list of the access rights for each account, see *OSD Access Rights*, page 83.

- ◆ **Enable.** To enable security and edit user accounts. When security is enabled, the *Guest* account will be disabled automatically, and the *Auto Login Enable* option will not be available.
- ◆ **User Password.** Edit the User account password. (numerical characters 0 to 9). The User account has port access with limited system and computer settings access and has no access to the configuration or security menus.
- ◆ **Power User Password.** Edit the Power User account password. (numerical characters 0 to 9). The Power User has port access, some system and computer settings access, limited configuration access, and no access to the stitchery menus.
- ◆ **Administrator Password:** Edit the Administrator account password. (numerical characters 0 to 9). The Administrator account has full access to all OSD menus.
- ◆ **RS232 Remote Login.** Allows logins from a serial device connection.
- ◆ **Auto Login Enable.** Check this box to bypass the login screen when the OSD menu is invoked. If security is enabled, this option is not available.

(Continues on next page.)

- ♦ **Login Timeout.** Set how long the OSD waits (minutes) after the last input before automatically logging out a user. Use (-) and (+) to assign a number between 1 and 99.



KVM Status

This read-only page shows useful information about the CM1164, including: the operating systems of computers connected to the ports; whether or not keyboard and mouse emulation, mouse port switching, and Power On Detection features are enabled; as well as the keyboard layout.



DCC Control

When multiple CM1164 units are daisy chained, check **Clone** to duplicate the settings of the parent CM1164 and deploy them to the succeeding CM1164 units in the daisy chain. The child units that are daisy chained will have an **Enable** check box - uncheck this box to remove the CM1164 from the daisy chain. See *Daisy Chaining*, page 13 for more information.

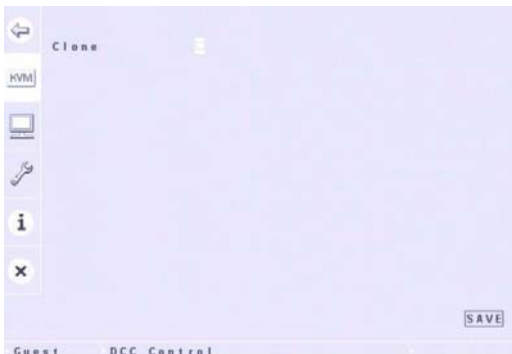

- ◆ The **Enable** option is only available on child units. The **Clone** option is only available on the parent unit.
- ◆ Once the units are daisy chain, the IR remote control will be disabled on the child units.

Computer

Use the *Computer* page to configure settings related to the hardware components of the CM1164 installation.



Keyboard Emulation

Check **Enable** to support keyboard emulation for error-free booting and hotkey functionality. Click **Save** to apply the setting.



Note: 1. PC keyboard combinations emulate Sun/Mac keyboards.
2. Sun/Mac keyboards only work with their own computers.

Mouse Emulation

Check **Enable** to support mouse emulation for error-free booting. Click **Save** to apply the settings. Mouse Emulation must be enabled for Hardware Cursor Mode, Channel Wheel Mode and Mouse Switching to work.



- ◆ **Mouse Switching Function.** Allows the mouse wheel to switch ports. When enabled, click the mouse wheel twice to switch to the next port.

Note: This feature applies to 3-key USB wheel mice only.

Power On Detection

The CM1164 has Power On Detection, which means that if the computer that has KVM focus is powered off, the CM1164 automatically switches to the next powered-on computer. Check **Enable** and then **Save** to apply the function.

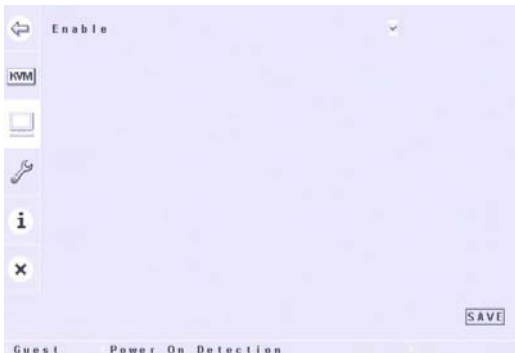

Set OS

This page lets you set the Operating System (OS) of the computer(s) attached to the port(s) to minimize compatibility issues. Check either **MAC**, **SUN** or **SPC** if the computer connected to the port runs on this particular OS. Check **Auto-Detect** to automatically detect the OS of the computer. Click **Save** to apply the settings.

Port	Auto-Detect	MAC	SUN	SPC
1	v	<input type="checkbox"/>	<input type="checkbox"/>	<input type="checkbox"/>
2	v	<input type="checkbox"/>	<input type="checkbox"/>	<input type="checkbox"/>
3	v	<input type="checkbox"/>	<input type="checkbox"/>	<input type="checkbox"/>
4	v	<input type="checkbox"/>	<input type="checkbox"/>	<input type="checkbox"/>

SAVE

Guest Set Operating System

USB Reset

Check **Enable** to reset the USB ports and have the CM1164 reinitialize the USB devices connected to ports. This helps clear any USB connectivity issues that may arise.

Enable

Guest USB Reset

Configuration

Use the *Configuration* page to configure the four front panel Fn keys, restore default values, upgrade the firmware, and backup/restore the OSD settings.



Fn Key

Use the *Fn Key* page to store display settings (**Edit**), and select which stored settings to display (**Selection**). The Fn keys can be used from the front panel pushbuttons, remote control, and via hotkey. Select *Edit* or *Selection* and follow the instructions provided on the next page.



Edit

This page lets you save the current display configuration to a function key (Fn1~Fn4). The configuration is of the current KVM, audio and USB focus, as well as the Display Mode.



Follow these steps to save a configuration:

1. Switch to the computer that will have KVM, audio and USB focus.
2. Set the Display Mode, so that its shown on the screen.
3. Open the OSD menu, and go to the *Fn Key – Edit* page. Check the function key (Fn1~Fn4) you want to assign the current configuration and click **Save**.

Selection

This page lets you select a function key to use. Check the function key (**Fn1**, **Fn2**, **Fn3** or **Fn4**) to use and click **Save**. The configuration is implemented immediately.



Restore Default Values

Check **Enable** to restore the default settings of the OSD menus. The default factory settings are applied immediately.



Firmware Upgrade

Check **Enable** to start a firmware upgrade. The front panel LEDs will flash orange to indicate the device is ready to upgrade. Refer to *Firmware Upgrade*, page 73 for instructions on how to upgrade the firmware.



OSD Config Backup Restore

This allows you to backup and restore OSD configurations. To use this option you must first connect a computer to the CM1164, as described below. When **OSD Config Backup Restore** is clicked the process starts running and the screen below appears:



To exit this screen power off the CM1164.

Backup / Restore

To backup/restore the OSD configuration, do the following:

1. Download the most recent Firmware Upgrade Package from our website.
2. Use an RJ-45 to DB-9 serial adapter (SA0141) to connect the computer's serial port to the **RS232 In** port on the CM1164.

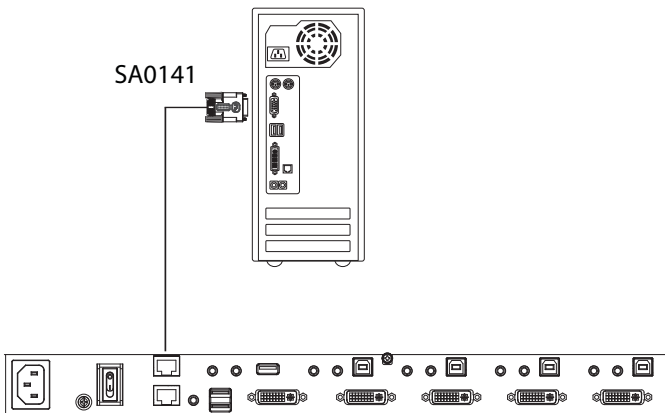

3. Open the OSD and go to *Configuration - OSD Config Backup Restore*.

- Run the Firmware Management Utility, select *OSD Configuration Backup/Restore* and click **Next**



- At the next screen click **Connect**.

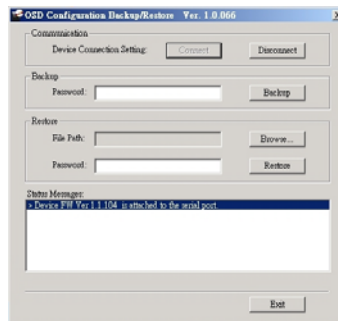

- If the computer is connected correctly a message will appear in the *Status Messages*:

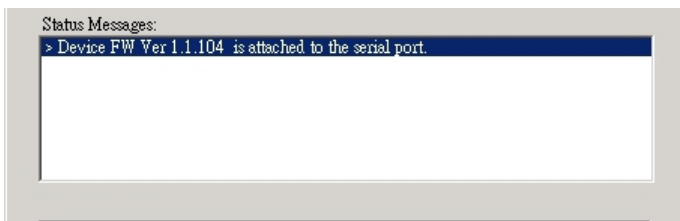

- To backup the OSD configuration, in the *Password* field, key in a password for the file and click **Backup**.

Note: 1. Setting a password is optional. If you do not set one, the file can be restored without specifying a password.

- If you do set a password, make a note of it, since you will need it to be able to restore the file.
-

- When the confirmation message appears, click **Yes**.

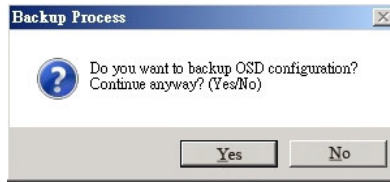

- Provide a name for the backup and click **Save**.



- A message appears indicating the backup was successful.

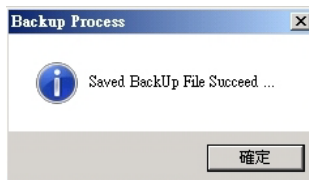

- To restore an OSD configuration, in the *Password* field, key in a password for the file (optional) and click **Browse**.
- Open the restore file and click **Yes**.
- The OSD configuration is restored.

Help

The *Help* page shows additional details related to the CM1164, as follows:

- ◆ **Hotkey List** - this page shows a list of hotkey commands available:

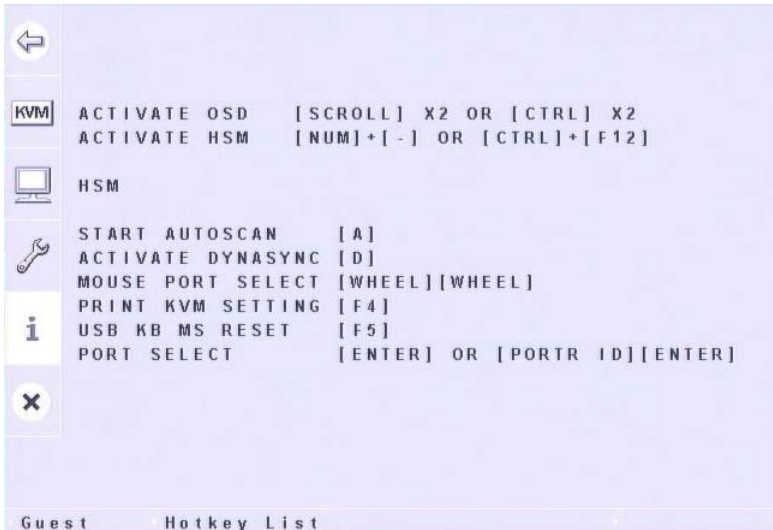

- ◆ **Info** - this page shows the current firmware version and copyright information:

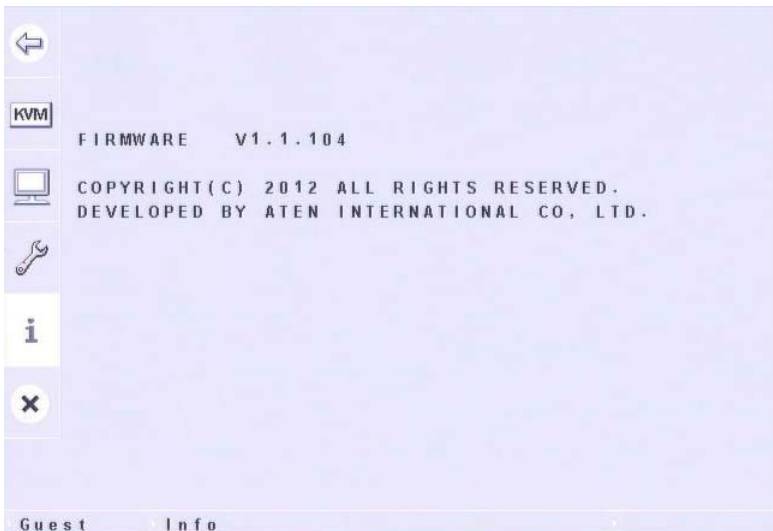

Channel ID

Depending on the Display Mode selected, the screen may be divided into two, three or four windows to show the computers connected to each port. Each window has a Channel ID that remains the same for all Display Modes. The Channel ID is not visible on the display.

The following diagrams illustrate the Channel ID positions for each Display Mode.

Quad View

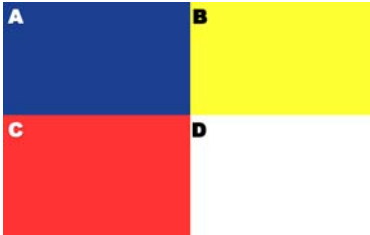

PiP Dual

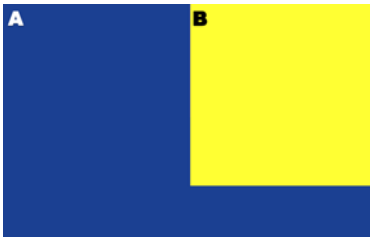

PiP Triple



PiP Quad

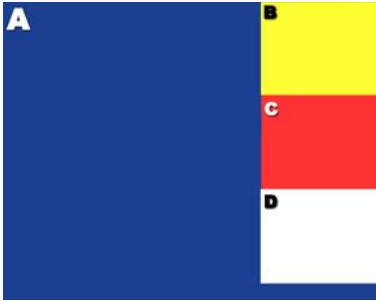

Note: There is an option to view Channel A in full so that the other channels do not cover the right side of the screen, but it is shown in a smaller resolution that allow all the channels to fit into the display. See *Picture in Picture (Dual / Triple / Quad)*, page 47 for details on how to use the Picture by Picture feature so that the channels do not overlap. This also applies to *PiP Quad Mode*.

Chapter 7

Firmware Upgrade

The Windows-based Firmware Management Utility provides a smooth, automated process for upgrading the CM1164's firmware. New firmware upgrade packages are posted on our Website as new firmware revisions become available. Check the web site regularly to find the latest packages and information relating to them:

<http://www.aten.com>

Before you Begin

To prepare for the Firmware Upgrade, do the following:

1. Using a computer connected to the CM1164 unit (via the DVI KVM Port Section, see *Rear View*, page 7), go to our Internet support site and choose the model name of your device (CM1164) to get a list of available Firmware Upgrade Packages.
2. Choose the Firmware Upgrade Package you want to install (usually the most recent), and download it to your computer.
3. Enable Firmware Upgrade through the OSD (see *Firmware Upgrade*, page 66). All the LEDs flash orange to indicate that Firmware Upgrade Mode is in effect.

Starting the Upgrade

1. Run the downloaded Firmware Upgrade Package file – either by double clicking the file icon, or by opening a command line and entering the full path to it. The *Firmware Management Utility* appears first:



2. Select the *Firmware Upgrade Utility* radio button and click **Next**.
3. The *Firmware Upgrade Utility* Welcome screen appears:

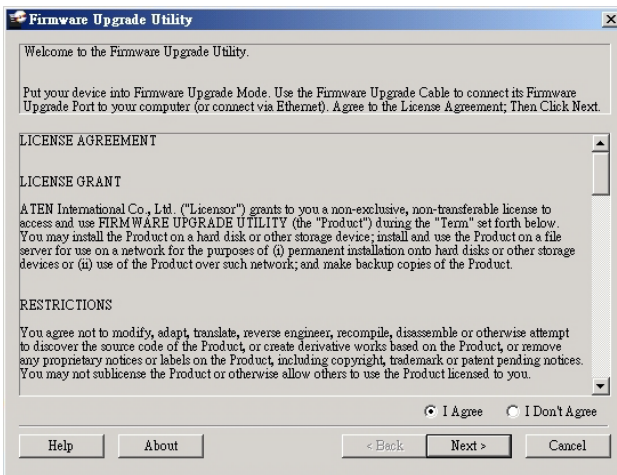

4. Read the License Agreement, select the *I Agree* radio button, and click **Next**.

- The Firmware Upgrade Utility main screen appears. The Utility inspects your installation. All the devices capable of being upgraded by the package are listed in the *Device List* panel.

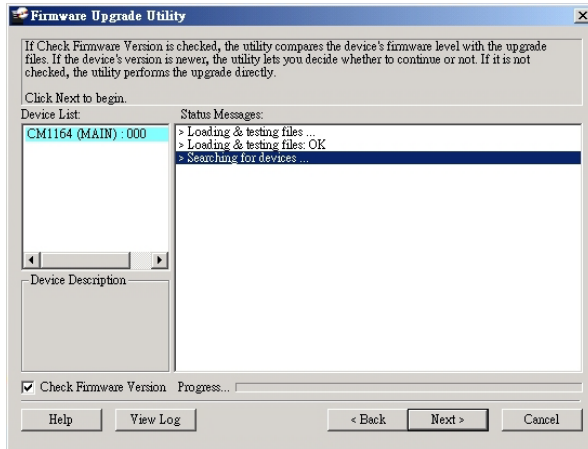

- As you select a device in the list, its description appears in the Device Description panel. After you have made your device selection, Click **Next** to perform the upgrade.

If you enabled **Check Firmware Version**, the Utility compares the device's firmware level with that of the upgrade files. If the device's version is higher than the upgrade version, a dialog box gives you the option to Continue: **Yes** or **No**.

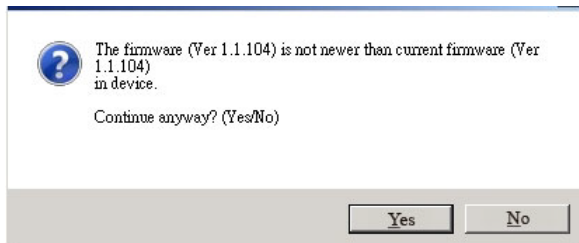

If you did not enable *Check Firmware Version*, the Utility installs the upgrade files without checking whether they are a higher level, or not.

As the Upgrade proceeds status messages appear in the Status Messages panel, and the progress toward completion is shown on the *Progress* bar.

Upgrade Succeeded

After the upgrade has completed, a screen appears to inform you that the procedure was successful:

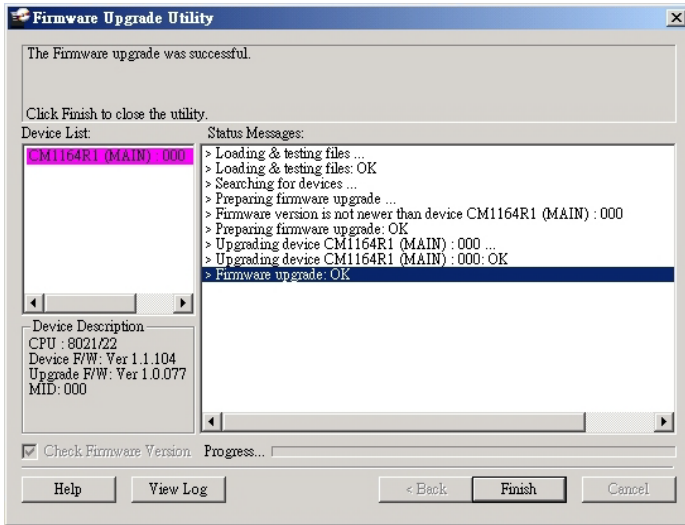

Click **Finish** to close the Firmware Upgrade Utility.

After a successful completion, the CM1164 exits Firmware Upgrade Mode, and resets itself. After the reset is complete, execute a Restore Default Value from the OSD (see *Restore Default Values*, page 66).

Upgrade Failed

If the *Upgrade Succeeded* screen does not appear, it means that the upgrade failed to complete successfully, in which case you should do the following:

1. Power off the CM1164 by removing the power cord.
2. Invoke Firmware Upgrade Mode by holding down the front panel *Mode Selection* pushbutton (see *Components*, page 6) and power on the CM1164. The KVM LEDs flash orange together.
3. Repeat the firmware upgrade procedure.

Safety Instructions

- ◆ This product is for indoor use only.
- ◆ Read all of these instructions. Save them for future reference.
- ◆ Follow all warnings and instructions marked on the device.
- ◆ Do not place the device on any unstable surface (cart, stand, table, etc.). If the device falls, serious damage will result.
- ◆ Do not use the device near water.
- ◆ Do not place the device near, or over, radiators or heat registers.
- ◆ The device cabinet is provided with slots and openings to allow for adequate ventilation. To ensure reliable operation, and to protect against overheating, these openings must never be blocked or covered.
- ◆ The device should never be placed on a soft surface (bed, sofa, rug, etc.) as this will block its ventilation openings. Likewise, the device should not be placed in a built in enclosure unless adequate ventilation has been provided.
- ◆ Never spill liquid of any kind on the device.
- ◆ Unplug the device from the wall outlet before cleaning. Do not use liquid or aerosol cleaners. Use a damp cloth for cleaning.
- ◆ The device should be operated from the type of power source indicated on the marking label. If you are not sure of the type of power available, consult your dealer or local power company.
- ◆ The device is designed for IT power distribution systems with 230V phase-to-phase voltage.
- ◆ To prevent damage to your installation, it is important that all devices are properly grounded.
- ◆ The device is equipped with a 3-wire grounding type plug. This is a safety feature. If you are unable to insert the plug into the outlet, contact your electrician to replace your obsolete outlet. Do not attempt to defeat the purpose of the grounding-type plug. Always follow your local/national wiring codes.
- ◆ Do not allow anything to rest on the power cord or cables. Route the power cord and cables so that they cannot be stepped on or tripped over.

- ◆ If an extension cord is used with this device make sure that the total of the ampere ratings of all products used on this cord does not exceed the extension cord ampere rating. Make sure that the total of all products plugged into the wall outlet does not exceed 15 amperes.
- ◆ To help protect your system from sudden, transient increases and decreases in electrical power, use a surge suppressor, line conditioner, or un-interruptible power supply (UPS).
- ◆ Position system cables and power cables carefully; Be sure that nothing rests on any cables.
- ◆ Never push objects of any kind into or through cabinet slots. They may touch dangerous voltage points or short out parts resulting in a risk of fire or electrical shock.
- ◆ Do not attempt to service the device yourself. Refer all servicing to qualified service personnel.
- ◆ If the following conditions occur, unplug the device from the wall outlet and bring it to qualified service personnel for repair.
 - ◆ The power cord or plug has become damaged or frayed.
 - ◆ Liquid has been spilled into the device.
 - ◆ The device has been exposed to rain or water.
 - ◆ The device has been dropped, or the cabinet has been damaged.
 - ◆ The device exhibits a distinct change in performance, indicating a need for service.
 - ◆ The device does not operate normally when the operating instructions are followed.
- ◆ Only adjust those controls that are covered in the operating instructions. Improper adjustment of other controls may result in damage that will require extensive work by a qualified technician to repair.

Technical Support

International

- ◆ For online technical support – including troubleshooting, documentation, and software updates: **<http://eservice.aten.com>**
- ◆ For telephone support, *Telephone Support*, page iv.

North America

Email Support		support@aten-usa.com
Online Technical Support	Troubleshooting Documentation Software Updates	http://www.aten-usa.com/support
Telephone Support		1-888-999-ATEN ext 4988

When you contact us, please have the following information ready beforehand:

- ◆ Product model number, serial number, and date of purchase.
- ◆ Your computer configuration, including operating system, revision level, expansion cards, and software.
- ◆ Any error messages displayed at the time the error occurred.
- ◆ The sequence of operations that led up to the error.
- ◆ Any other information you feel may be of help.

Specifications

Function		CM1164	
Computer Connections		4	
Port Selection		Front Panel Pushbuttons; Hotkeys; IR Remote Control; On-Screen Display (OSD)	
Connectors	Console Ports	KB	1 x USB Type A Female (Black; rear panel)
		Video	1 x Single Link DVI-D Female (White)
		Mouse	1 x USB Type A Female (Black; rear panel)
		Speaker	2 x Mini Stereo Jack Female (Green; 1 x front panel, 1 x rear panel)
		Mic.	2 x Mini Stereo Jack Female (Pink; 1 x front, 1 x rear)
		DC Control	2 x RJ-45
	Computer Ports	KB/ Mouse	4 x USB Type B Female (White)
		Video	4 x Single Link DVI-D Female (White)
		Speaker	4 x Mini Stereo Jack Female (Green)
		Mic.	4 x Mini Stereo Jack Female (Pink)
	Power		1 x IEC320 Jack
	USB 2.0 Hub		2 x USB Type A Female (White; 1 x front panel; 1 x rear panel)
	Switches	Selected	11 pushbuttons
	LEDs	KVM	4 (Orange)
Audio		4 (Green)	
USB		4 (Green)	
Emulation	Keyboard / Mouse	USB	
Video		1920 x 1200 @ 60 Hz (DVI-D)	
Scan Interval		1–99 secs. (Default: 5 secs)	
Power Consumption		100V 6.7 W 240V 13.6 W	
Environment	Operating Temp.	0–40°C	
	Storage Temp.	-20–60°C	
	Humidity	0–80% RH, Non-condensing	
Physical Properties	Housing	Metal	
	Weight	2.5 kg	
	Dimensions (L x W x H)	43.72 x 16.38 x 4.40 cm	

Troubleshooting

Operation problems can be due to a variety of causes. The first step in solving them is to make sure that all cables are securely attached and seated completely in their sockets. In addition, updating the product's firmware may solve problems that have been discovered and resolved since the prior version was released. If your product is not running the latest firmware version, we strongly recommend that you upgrade. See Chapter 7, **Firmware Upgrade**, for details.







Symptom	Possible Cause	Action
Mouse and/or Keyboard not responding.	Improper mouse and/or keyboard reset.	Unplug the cable(s) from the console port(s), then plug it/them back in.
	KVM switch needs to be reset.	Power off all devices on the installation (see safety note, page 9); power off the KVM switch; wait five seconds; then power up
USB devices not responding.	USB ports need to reset.	Unplug the device's USB cable from the USB port on the switch's rear panel, then plug it back in.
	PC or OS does not support USB 2.0.	The CM1164 has a built-in USB 2.0 hub, so does not support PCs or OS that do not support USB 2.0.
Device not recognized (Windows).	Windows timing problem.	Unplug the KVM cable from the computer's USB port; go into Windows' <i>System Settings</i> and remove the <i>Unknown Device</i> entry; plug the KVM cable back in. Windows now recognizes the device.
Cannot switch ports by pressing [Scroll Lock] twice	Keyboard is incompatible with Scroll Lock invocation.	Press Ctrl key instead.
Monitor does not display after KVM cable set is hot plugged.	Some DVI graphics cards are incompatible with cable set hot plugging.	Power off all devices on the installation (see safety note, page 9); power off the CM1164; confirm all KVM cables are properly connected; power on the CM1164; power on the computers

(Continues on next page.)

(Continued from previous page.)

Symptom	Possible Cause	Action
When switching ports, the monitor does not display.	Monitor is new or this is a first time installation.	Switch ports again and wait two or more seconds for the PC's EDID to pass to the monitor.
	The PC's EDID has not passed through to the monitor when switching ports	Use the [d] hotkey to invoke Video DynaSync one more time or switch to another PC to reconnect the CM1164. See <i>Video DynaSync</i> , page 34 or <i>Video DynaSync</i> , page 55.
The GUI connection window stalls / does not connect	The CM1164 needs to be reset.	Perform a KVM reset or reinstall the latest CM1164 software on all your computers.

OSD Access Rights

OSD Menu Page	Sub-menu / Functions	Sub-menu 2 / Functions	Sub-menu 3 / Functions	Guest 00000	User 33333	Power User 22222	Administrator 11111
 OSD Front page Port Selection	Function Mode/Display Mode/ Port Selection/Station Selection			Y	Y	Y	Y
	Quad	Port/Channel Selection		Y	Y	Y	Y
	PIP Dual	Port/Channel Selection/Alpha/Scan/PIP/Channel Size		Y	Y	Y	Y
	PIP Triple	Port/Channel Selection/Alpha/Scan/PIP/Channel Size		Y	Y	Y	Y
	PIP Quad	Port/Channel Selection/Alpha/Scan/PIP/Channel Size		Y	Y	Y	Y
	Mode	Disable Channel			Y	N	N
 Quadview Resolution Startup Display Mode	1280x720~1920x1080 (9 sets of resolution available)			Y	Y	Y	Y
	Full screen/Quad/PIP Dual/PIP Triple/PIP Quad			Y	N	N	Y
 Station	Station/Port Selection			Y	Y	Y	Y
		Hardware Cursor	Enable/Channel Wheel/Cursor Type	Y	N	N	Y
 System Setting		OSD Hotkey	Scroll lock / Qrt	Y	N	N	Y
		Holley Setting Mode	Enable/Num Lock/Ctrl	Y	N	N	Y
		Video Dynasync	Enable/Reload/Default	Y	N	N	Y
		Activate Beeper	Enable	Y	N	N	Y
		Port ID Display	Port Duration	Y	N	N	Y
		System	OSD Language	English/German/French/Japanese/T. Chinese	Y	N	Y
		Keyboard Language	French/English/Japanese		Y	N	Y
		Auto Scan	Scan Duration/Scan Mode		Y	Y	Y
		Security	Enable/User-Power User-Admin PWD/Login		Y	N	N
		KVM Status	Timeout/RS232/Auto Login		Y	N	Y
		DCC Control	Clone		Y	N	Y
		Keyboard Emulation	Enable		Y	N	Y
		Mouse Emulation	Enable/Mouse Switching Function		Y	N	Y
		Computer	Power On Detection	Enable	Y	Y	Y
			Set Operation System	Port/Auto-Detect/IMAC-SUN-SPC	Y	N	Y
			USB Reset	Enable	Y	Y	Y
			Fn Key	Edit/Selection	Y	N	Y
		Restore Default Values	Enable	Y	N	Y	
	Configuration	Firmware Upgrade	Enable	Y	N	Y	
		OSD Config Backup Restore		Y	N	Y	
	Help	Hotkey List		Y	Y	Y	
	Close	Info		Y	Y	Y	
 Close				Y	Y	Y	Y
 Logout				Y	Y	Y	Y

Display Mode Reference

Use the information below as a quick reference to invoke the display modes.

Switch among Display Modes

Display Modes	Full Screen	Quad-View	PIP Dual	PIP Triple	PIP Quad
KVM Front Panel					
IR Remote					
On-Screen Control Panel (mouse)	N/A				
Keyboard Hotkey					
OSD Front Page					

Fn Key Reference









Use the information below as a quick reference to invoke the Fn keys.

Choose a preset configuration (Fn keys)

Preset configuration	Fn1	Fn2	Fn3	Fn4
KVM Front Panel				
IR Remote				
On-Screen Control Panel (mouse)				
Keyboard Hotkey				
OSD Front Page				

Mac Keyboard Emulation







The PC compatible (101/104 key) keyboard can emulate the functions of the Mac keyboard. The emulation mappings are listed in the table below.

PC Keyboard	Mac Keyboard
[Shift]	Shift
[Ctrl]	Ctrl
	
[Ctrl] [1]	
[Ctrl] [2]	
[Ctrl] [3]	
[Ctrl] [4]	
[Alt]	Alt
[Print Screen]	F13
[Scroll Lock]	F14
	=
[Enter]	Return
[Backspace]	Delete
[Insert]	Help
[Ctrl] 	F15

Note: When using key combinations, press and release the first key (Ctrl), then press and release the activation key.

Sun Keyboard Emulation

The PC compatible (101/104 key) keyboard can emulate the functions of the Sun keyboard when the Control key [Ctrl] is used in conjunction with other keys. The corresponding functions are shown in the table below.

PC Keyboard	Sun Keyboard
[Ctrl] [T]	Stop
[Ctrl] [F2]	Again
[Ctrl] [F3]	Props
[Ctrl] [F4]	Undo
[Ctrl] [F5]	Front
[Ctrl] [F6]	Copy
[Ctrl] [F7]	Open
[Ctrl] [F8]	Paste
[Ctrl] [F9]	Find
[Ctrl] [F10]	Cut
[Ctrl] [1]	
[Ctrl] [2]	
[Ctrl] [3]	
[Ctrl] [4]	
[Ctrl] [H]	Help
	Compose
	

Note: When using key combinations, press and release the first key (Ctrl), then press and release the activation key.

Factory Default Hotkeys and Settings

Setting	Hotkey	Default
Port Switching (Default / Alternate)	[T]	[Scroll Lock] [Scroll Lock]
Invoking HSM	[H]	[Number Lock] [-]
Auto Scan Interval	[Scroll Lock] [Scroll Lock] [A] [Enter]	5 seconds
Keyboard Operating Platform	[F10]	PC Compatible
Mouse Emulation	[M]	Enabled
Keyboard Emulation	[N]	Enabled
Mouse Wheel Support	[W]	Disabled
Buzzer	[B]	Enabled
Keyboard Language	[F6] [nn] [Enter] Note: nn is the language number	English

Limited Warranty

IN NO EVENT SHALL THE DIRECT VENDOR'S LIABILITY EXCEED THE PRICE PAID FOR THE PRODUCT FROM DIRECT, INDIRECT, SPECIAL, INCIDENTAL, OR CONSEQUENTIAL DAMAGES RESULTING FROM THE USE OF THE PRODUCT, DISK, OR ITS DOCUMENTATION.

The direct vendor makes no warranty or representation, expressed, implied, or statutory with respect to the contents or use of this documentation, and especially disclaims its quality, performance, merchantability, or fitness for any particular purpose.

The direct vendor also reserves the right to revise or update the device or documentation without obligation to notify any individual or entity of such revisions, or update. For further inquiries, please contact your direct vendor.